

Mandatory Energy Audit (2022-23) for Punjab State Power Corporation Limited as per Bureau of Energy Efficiency (Manner and Intervals to Conduct Energy Audit in electricity distribution companies) as per Regulations, 2021 Notified on 06.10.2021

[Period of Audit 19-06-2023 to 22-06-2023]



Punjab State Power Corporation Limited

PSEB Head Office, The MALL, Patiala-147001

Prepared For



Bureau of Energy Efficiency

[Government of India–Ministry of Power]

4thFloor,SewaBhawan,R.K.Puram,NewDelhi–110066,India

Prepared By



Katyani Energy Solution Private Limited, New Delhi

Office: 138B/1 3RD Floor, Mohammadpur, Delhi-110066

Phone: +91-11-4079 3249 , +91 9868615189

Email:katyanienergy@gmail.com Website: www.katyanienergy.com

Contents

1. Acknowledgment	4
2. Team Of Energy Audit	5
3. Executive Summary:.....	6
4. Overview of PSPCL	8
4.1. General Information –as per BEE Format	8
4.2. Field structure of Power Distribution	18
PSPCL consumers of different categories	20
4.3. Profile of Punjab State Electricity Board	21
5. PSPCL Network.....	23
5.1. Power Flow Chart of PSPCL Network.....	23
5.2. Metering and Billing arrangement.....	23
5.3. Category of Feeders	25
5.4. Scope of Work of MEA	25
6. Notification and Category of Consumers.....	27
6.1. Category of Consumers.....	27
6.2. Provisions of subsidy.....	28
6.3. Policy for calibration of Meters	29
7. Energy Audit of PSPCL.....	31
7.1. Methodology for Energy Audit FY 2022-2023	31
7.2. Methods of data collection	32
7.3. Analysis of Data Collected for Determining of Billing and collection efficiency	33
8. Performance Assessment of PSPCL.....	34
8.1. Performance Assessment	34
i) Feeders.....	34
ii) Meters (For Consumers 66 KV)	34
iii) Feeder Meters.....	34
iv) Transformer Meter	35
v) RPO (Renewable purchase obligation)	35
Provisions for RPO.....	35

Audit Detail Of PSPCL

v) RPO (Renewable purchase obligation).....	33
Provisions for RPO	34
vi) Technical Setup for online monitoring.....	34
vii) Reactive Power Management.....	35
8.2. Loss % Zone-wise/Circle-wise	35
8.3. Graph Of Losses	35
9. Recommendations.....	36
10. List of abbreviations.....	39
11 Annexure ...(BEE Formats).....	45-335

1. Acknowledgment

M/S Katyani Energy Solution Pvt Ltd is thankful to PSPCL, Head Qr at MALL, Patiala – 147001 for co-operation during mandatory energy audit for FY 2022-2023.

Special thanks to Er. Hira Lal Goyal, Chief Engineer (Energy Audit & Enforcement) for their valuable contribution in deliberation over network and management aspects.

The interaction and deliberation with Er.Davinder Kumar, ASE (DSM) has been very much useful in completion of energy audit task assigned by PSPCL. We thank to Er. Ravi Verma, ASE (Energy Manager, EA-7969) and Er. Parupkar Singh, ASE (Energy Manager, EA-7256) for his co-operation in providing data and details to Audit Team.

The study team also acknowledges the contribution of Er. Anil Kumar, Dy CE/DSM for coordinating the activities of Energy Audit.

In the last but not the least we thank to Er. Bikram Sharma, AE (DSM) for being associated with audit team all along the audit work & providing basic inputs of Energy Audit as and when required.

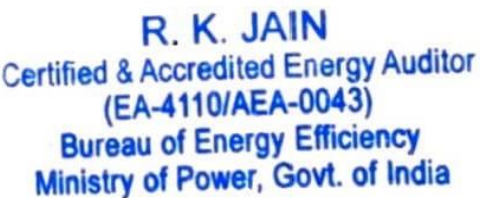
Abhay Jain	R.K. Jain
	
<p>Certified Energy Auditor (EA-9553) & DISCOM Expert, M/S KESPL New Delhi</p>	<p>Accredited Energy Auditor (A.E.A. – 0043) Associate Director, M/S KESPL New Delhi</p>

2. Team Of Energy Audit

Name of Team Members	Experts	Brief Introduction
Mr. R.K. Jain	Accredited Energy Auditor AEA - 0043	He has experience of 47 years in thermal power plants / Iron & Steel and commercial buildings etc. Under PAT scheme of BEE.
Mr. Akshay Kumar	Certified Energy Auditor (34721) & DISCOM Expert	He is an Ex Executive Director (JUSNL & JUUNL of erstwhile JSEB. He has experience of 36 years in Transmission, Generation (Thermal Power station), SLDC (Power System Manager) and Energy Audit.
Mr. A.K. Jain	Certified Energy Auditor (9553) & DISCOM Expert	Ex-SE UPPCL, Certified Energy Auditor
Mr. R. Kumar	Energy Engineer	He has experience of 3 years working in KESPL, reputed energy firm in New Delhi.

3. Executive Summary:

Punjab State Power Corporation limited (PSPCL), headquarter at the Mall, Patiala after unbundling of PSEB, came into existence in 2010. It bears the responsibility of generation and distribution of power to various categories of consumers. The coordinating agency, BEE, has framed regulation in exercise of power conferred upon under clause (g) and (n) of section 14 of the energy conservation act 2001 (Amended in 2010) for the designated consumers.

PSPCL has awarded the work of mandatory energy audit for FY 2022-23 vide work order number 002 Dated 9.5.2023 to M/S Katyani energy solution private limited, Delhi.

The objective of mandatory energy audit is to conduct energy audit to know

- a) Losses of power in distribution network of various voltages
- b) Assess the metering status (Functional, Nonfunctional and Unmetered)
- c) Types of meter connected
- d) Monitoring mechanism of system 66 KV to 0.415 KV network and consumers connected at different voltages of various categories
- e) Calculation of billing efficiency and collection efficiency

The connected load of all category is 42842.798 MW, which consumes annual input energy (At DISCOM Periphery) 66160.34 MU. The actual sold power stands to be 58708.60 MU to the consumers. The billing efficiency stands to be 89.34%. The category-wise load calculation & percentage and energy consumption along with percentage are mentioned below.

Category	Kind	Connected Load MW	%	Energy in MU	%
Residential		15110.24	35.269	17493.719	29.595
Agricultural		11183.546	26.103	13762.566	23.283
Industrial	Commercial HT	8244.255	19.243	8282.153	14.011
	Commercial LT	7854.89	18.334	17471.637	29.558
Others		449.98	1.050	2099.194	3.552
Net		42842.798 MW	100	58708.60 MU	100

Subsidized and Nonsubsidised energy

Category	Energy Sold in MU	%	Revenue Collection in Rs Crore	%	Remarks
Subsidized	25564	43.25	16434.46	44.26	Calculated
Nonsubsidised	33144.60	56.75	20695.84	55.74	Calculated
Total	58708.60	100	37130.30	100	Collection without Arrear

Note:- 59109.2 MU includes theft and short calculation. 58708.60 MU is equivalent to constant load of 6747.63 MW over the period of FY 2022-23. The energy supplied may be categorized as subsidized

energy and Non-subsidize energy. The agriculture is 100% subsidized. The realization of subsidy bills from government is 100%. The subsidized energy stands at 43.25% of total energy billed and non subsidized energy stands 56.75% of the energy billed.

Collection efficiency is 100% as actual Collection Efficiency 112.72 % restricted upto 100% as per PFC guidelines. The AT&C losses come out to be 11.26% (Reference 6.3).

The metering arrangement of network does not redress the BEE requirement. Feeders are not provided meters in both ends. DTs are not having meters in input and output end. Agriculture consumers about 99.38% of total agriculture consumers are not metered. Right now they are not being served bill due to 100% subsidy. But if any government withdraws subsidy provisions then the individual consumer would be required to serve bill for the energy consumption. They are being given 8 hours power in a day. So, they are bound to take separate connection for the domestic supply.

The loss assessment shows that Border Zone is maximum theft prone area, which needs special attention to control it.

The approval for purchase of energy by regulatory commission for FY 2022-23 is Rs 4.37 per unit and the sale price works out to be Rs 6.45 per unit. The approved quantity of energy sales for FY 2022-23 by Regulatory commission is 55521 MU.

The approved T&D loss by the commission is 12.40% where as the actual T&D loss stands to be 11.26%. The approved cost of power purchase is Rs 23258 crore for FY 2022-23, but the actual cost of power at the input of periphery of DISCOM stands to Rs 28912 crore. The loss of transmission energy cost may further added up to make the actual cost of power at the source of generation more than this.

The 11 KV feeders are dedicated to different category of consumers. Consumers are categorized broadly as Residential, Agriculture, Commercial/Industrial LT, Commercial HT and others category (Mixed load). The details of connection, metering, load, losses and collection as per these categories are provided, but assessment has been made at Division level.

As per mandatory requirement under regulatory provision of Central regulatory commission the penetration of solar power and net metering in PSPCL Network are not adequate. So use of solar power should be encouraged among agricultural consumers, which are provided 8 hours of power supply in a day for agriculture work.

SAP is functioning at Apex level but performing the job of collecting data from consumers of different categories, by various modes of fetching, i.e. through AMR/SMART meter, communicable meters, non communicable meters and unmetered consumers by assessment. So, functioning of data centers at different level are absent for monitoring of parameters as per BEE guide lines.

So, it is difficult to assess and verify mixed mode of billing. The system losses in the different feeders and DT- wise load & loss assessment could not be possible without 100% online monitoring and acquisition of data to Data Centre through 100% communicable (Preferably AMR/SMART type)

meters at each input and output of system elements (Feeder, Power Transformers, Distribution Transformers and consumers).

- PSPCL has tremendous potential to achieve the goal of 100% online monitoring of all the parameters prescribed by BEE and become front runner among the DISCOM.
- The target for T&D loss in the PAT scheme for FY 2024 – 25 is 12.40 %. In the base year 2018 – 19 T&D loss was 12.94 % and Input energy was 54037.64 MU.
- The source generation is 70329.40 MU, the loss in transmission of power @ 400 KV, 220 KV, 132 KV and 66 KV lines is 4169.4 MU. So there is a loss of 5.92 % from generating station to 66 KV bus at PSPCL. At 66 KV bus (Input Periphery) net input power is received 66160.34 MU. Thereafter transmission of power over 11 KV, Distribution transformer, 440 Volt LT lines reached to consumers, the loss of power in distribution network is 7451.75 MU (11.26 % of input energy at 66 KV bus). Considering actual loss of EHT inter state transmission lines (400 KV,220 KV, 132 KV,66 kv) is 1440.37 Mu i.e. 2%. The intra state transmission loss under the jurisdiction of PSTCL & PSPCL works out to be 3.92%. So all together transmission and distribution loss (T&D) of PSPCL & PSTCL network stands to be 14.58 % (3.92 + 10.66) out of which only DISCOM PSPCL distribution losses are 11.26%.

3.1. Overview of PSPCL

3.1.1. General Information – as per BEE Format filled by DC

General Information			
1	Name of the DISCOM	Punjab State Power Corporation Limited (PSPCL)	
2	i) Year of Establishment	2010	
	ii) Government/Public/Private	Government	
3	DISCOM's Contact details & Address		
i	City/Town/Village	Patiala	
ii	District	Patiala	
iii	State	Punjab	Pin 147001
iv	Telephone	0175-2212005	Fax 0175-2213199
4	Registered Office		
i	Company's Chief Executive Name	Er. Baldev Singh Sran	
ii	Designation	CMD PSPCL	
iii	Address	The Mall, Patiala	
iv	City/Town/Village	Patiala	P.O. Patiala

Mandatory Audit Detail Of PSPCL





v	District	Patiala		
vi	State	Punjab	Pin	147001
vii	Telephone	0175-2212005	Fax	0175-2213199
5 Nodal Officer Details*				
i	Nodal Officer Name (Designated at DISCOM's)	Er. Hira Lal Goyal		
ii	Designation	Chief Engineer (Energy Audit & Enforcement)		
iii	Address	Shed No. B2, Shakti Vihar, Patiala		
iv	City/Town/Village	Patiala	P.O.	Patiala
v	District	Patiala		
vi	State	Punjab	Pin	147001
vii	Telephone	0175-2215774	Fax	0175-2215774
6 Energy Manager Details*				
i	Name	Er. Ravi Verma		
ii	Designation	ASE	Whether EA or EM	EA
iii	EA/EM Registration No.	EA-7969		
iv	Telephone	Fax		
v	Mobile	96461 21187	E-mail ID	ivarverma76@gmail.com
7 Period of Information				
	Year of (FY) information including Date and Month (Start & End)	1 APRIL 2022 - 31 March 2023		

3.1.2. Summary Sheet

Performance Summary of Electricity Distribution Companies			
1	Period of Information Year of (FY) information including Date and Month (Start & End)		1 APRIL 2022 - 31 March 2023
2	Technical Details		
(a)	Energy Input Details		
(i)	Input Energy Purchase (From Generation Source)	Million kwh	70329.40
(ii)	Net input energy (at DISCOM Periphery after adjusting the transmission losses and energy traded)	Million kwh	66160
(iii)	Total Energy billed (is the Net energy billed, adjusted for energy traded))	Million kwh	58708.60
(b)	Transmission and Distribution (T&D) loss Details	Million kwh	7451.75
		%	11.26%
	Collection Efficiency	%	100.00%
(c)	Aggregate Technical & Commercial Loss	%	11.26%

I/We undertake that the information supplied in this Document and Pro-forma is accurate to the best of my knowledge and if any of the information supplied is found to be incorrect and such information result into loss to the Central Government or State Government or any of the authority under them or any other person affected, I/we undertake to indemnify such loss.

Authorised Signatory & Seal		Signature	
Name of Discom	PUNJAB STATE POWER CORPORATION LTD	Name of Energy Manager	Er. Ravi Verma
Full Address		Registration Number	EA-7969

Form-Details of Input Infrastructure					
Sr No.	Parameters	Total	Covered during in audit	Verified by Auditor in Sample Check	Remarks (Source of data)
I	Number of circles	21	21	21	CE/Planning
ii	Number of divisions	104	104	104	CE/Planning
iii	Number of sub-divisions	508	508	508	CE/Planning
iv	Number of feeders	13148	13148	13148	Director / D
V	Number of DTs	1200300	1200300	1200300	Director / D
vi	Number of consumers	10513750	10513750	10513750	CE/Planning

2	Parameters	66kV and above	33kV	11/22kV	LT
a. i.	Number of conventional metered consumers	31	0	7511	7872441
ii	Number of consumers with 'smart' meters	0	0	114	140038
iii	Number of consumers with 'smart prepaid' meters	0	0	0	1416
iv	Number of consumers with 'AMR/SMART' meters	196	3	8831	35671
v	Number of consumers with 'non-smart prepaid' meters	4	3	475	1064582
vi	Number of unmetered consumers	0	0	0	1382434
vii	Number of total consumers	231	6	16931	10496582
b.i.	Number of conventionally metered Distribution Transformers	0	0	25943	0
ii	Number of DTs with communicable meters	1420	2	33754	0
iii	Number of unmetered DTs	0	0	1140603	0
iv	Number of total Transformers	1420	2	1200300	0

Mandatory Audit Detail Of PSPCL



2	Parameters	66kV and above	33kV	11/22kV	LT
c.i.	Number of metered feeders	168	5	12975	0
ii	Number of feeders with communicable meters	168	5	12975	0
iii	Number of unmetered feeders	0	0	0	0
iv	Number of total feeders	168	5	12975	0
d.	Line length (ct km)	14289 KM,	71 Km	252006 Km	153732 Km.
e.	Length of Aerial Bunched Cables	NA	NA	NA	NA
f.	Length of Underground Cables	NA	NA	NA	NA

3	Voltage level	Particulars	MU	Reference	Remarks (Source of data)
i	66kV and above (Inter-State)	Long-Term Conventional	25172.24	Includes input energy for franchisees	
		Medium Conventional (unscheduled interchange)	-441.94		value of unscheduled interchange energy is entered as the provision of the same has not provided in the performa
		Short Term Conventional	7471.95		10874.18-436.37
		Banking	311.80		
		Long-Term Renewable energy	2691.16		

3	Voltage level	Particulars	MU	Reference	Remarks (Source of data)
		Medium and Short-Term RE	0.00	Includes power from bilateral/ PX/ DEEP	
		Captive, open access input		Any power wheeled for any purchase other than sale to DISCOM. Does not include input for franchisee.	
		Sale of surplus power	-502.87		
		Quantum of inter-state transmission loss	1440.37	As confirmed by SLDC, RLDC etc	
		Power procured from inter-state sources	34702.34	Based on data from Form 5	
		Power at state transmission boundary	33261.97		
ii	66kV and above (Intra-State)	Long-Term Conventional	33411.30		Power procured from intra state sources at different voltage levels
		Medium Conventional	NA		
		Short Term Conventional	NA		
		Banking	NA		
		Long-Term Renewable energy	1975.30		NRSE power procured from intra state sources at 66KV and above
		Medium and Short-Term RE			

Mandatory Audit Detail Of PSPCL



3	Voltage level	Particulars	MU	Reference	Remarks (Source of data)
		Captive, open access input			
		Sale of surplus power			
		Quantum of intra-state transmission loss	2728.688		PSTCL Losses + PSPCL Sub transmission Losses
		Power procured from intra-state sources	35386.59		
iii		Input in DISCOM wires network	65920		
iv	33 kV	Renewable Energy Procurement	10.39		
		Small capacity conventional/ biomass/ hydro plants Procurement	0.00		
		Captive, open access input	0.00		
v	11 kV	Renewable Energy Procurement	230.07		NRSE power procured from intra state sources at 11KV
		Small capacity conventional/ biomass/ hydro plants Procurement	0.00		
		Sales Migration Input			
vi	LT	Renewable Energy Procurement	101.91		Roof Top Solar Energy
		Sales Migration Input	-101.91		

Mandatory Audit Detail Of PSPCL



3	Voltage level	Particulars	MU	Reference	Remarks (Source of data)
vii	Energy Embedded within DISCOM wires network	Energy Embedded within DISCOM wires network	240.46		
viii	Total Energy Available/ Input	Total Energy Available/ Input	66160.34		

4	Voltage level	Energy Sales Particulars	MU	Reference	
I	11KV/LT	DISCOM' consumers		Include sales to consumers in franchisee areas, unmetered consumers	
		Demand from open access, captive	0	Non DISCOM's sales	
		Embedded generation used		Demand from embedded generation at LT level	
		Sale at 11KV/LT level	0.00		Voltage wise energy requirement input not available instead available source wise.
		Quantum of 11KV/LT level losses	0.000		
		Energy Input at 11 KV/ LT level			
ii	33 kV Level	DISCOM' consumers		Include sales to consumers in franchisee areas, unmetered	

4	Voltage level	Energy Sales Particulars	MU	Reference
				consumers
		Demand from open access, captive	0	Non DISCOM's sales
		Embedded generation at 33 kV level used		Demand from embedded generation at 11kV level
		Sales at 33 kV level	0.00	
		Quantum of Losses at 33 kV	0.000	
		Energy input at 33 kV level		
iii	66/33/11 / 0.44 KV	DISCOM' consumers	58708.60	Include sales to consumers in franchisee areas, unmetered consumers
		Demand from open access, captive	0	Non DISCOM's sales
		Embedded generation at 66 kV or below level		This is DISCOM and OA demand met via energy generated at same voltage level
		Sales at 66 kV level	58708.60	
		Quantum of Losses at 66 kV	7451.75	
		Energy input at 66kV Level	66160	
iv	> 66 kV	DISCOM' consumers		Include sales to consumers in franchisee areas, unmetered consumers
		Demand from open access, captive	0	Non DISCOM's sales
		Cross border sale of energy	0	
		Sale at other DISCOMs	0	
		Banking	0	

4	Voltage level	Energy Sales Particulars	MU	Reference
		Energy input at > 66kV Level	4169	
		Sales at 66kV and above (EHV)		
		Total Energy Requirement	70329.40	
		Total Energy Sales	58708.60	

Energy Accounting Summary					
5	DISCOM	Input (in MU)	Sale (in MU)	Loss (in MU)	Loss %
i	LT				
ii	11KV				
iii	33 KV				
iv	66/33/11 / 0.44 KV	66160.34	58708.60	7451.75	11.26%
6	Open Access, Captive	Input (in MU)	Sale (in MU)	Loss (in MU)	
i	LT	0	0	0	
ii	11 Kv	0	0	0	
iii	33 kv	0	0	0	
iv	> 33 kv				
Loss Estimation for DISCOM					
	T&D loss	11,220			
	D loss	7,452			
	T&D loss (%)	16.52%			
	D loss (%)	10.60%			
<p>NOTE: D losses 10.60 % are Calculated on the basis of availability of Power to PSPCL (At Generation Sources) i.e.70329 MU and D Losses in Division Wise Losses Sheet 11.26 % are calculated by Net input energy (At DISCOM Periphery after adjusting the transmission losses and energy traded) i.e. 66160 MU bases.</p>					

3.2. Field structure of Power Distribution

PSPCL is state undertaking and has responsibility of distribution of power within the state of Punjab. The administrative units of governing its several technical administrative and accounting functions are as mentioned below – (Reference Annexure -3 - detailed collection efficiency upto the q4- 2022-23.

Zone	Circle	Division	Subdivisions
1. Border	AMR/Smartitsar City AMR/Smartitsar sub urban Gurudaspur Taran Taren 4 Circles	AMR/Smartitsar city, East division AMR/Smartitsar, West division AMR/Smartitsar, Sub urban division AMR/Smartitsar Ajnala, Jalandhar Guru division, Pathankot city division, Sub urban Pathankot, Gurudaspur division, Dhariwal division, Batala city division, Batala sub urban division, Shree Hargovindpur Sahib division, Tarn Taran city division, Tarn Taran sub urban division, Rayya division, Path division, Bhikhiwind division (18 Divisions)	508 Sub-Divisions
2. North	Hoshiarpur, Jalandhar, Kapurthala, Nawanshahr (4 Nos)	Hoshiarpur city division, Hoshiarpur sub urban division, Dasuya division, Bhogpur division, Mahilpur division, East division Jalandhar, West division Jalandhar, Model town division Jalandhar, Cant division Jalandhar, Phagware division, Kapurthala city division, Kartarpur division, Nokadar city division, Nokadar sub urban division, Nawanshahr division, Banga division, Garhshakar division, Gorayas division, (19 Nos) – 1 missing	
3. South	Barnala,	Barnala City division,	

Zone	Circle	Division	Subdivisions
	Mohali, Patiala, Ropar, Sangrur (5 No's)	Malerkotla division,, Barnala Sub urban division, Dhuri division, Mohali division, Zirakhpur division, Lalree division, Patiala East division, Patiala West division, Patiala Sub Urban division, Rajpura division, Nakha division, Samana division, Sor division, Genral commercial division Patiyala, Ropar division, Kharar division, Anandpur Sahib division, SAMR/SmartalaPatran division, Sangrur city division, Sangrur division, LehraGagga division, Dirba division (23 No's)	
4. West	Bhatinda, Faridkot, Ferozpur Muktsar (4 No's)	Bhatinda city division, Bhatinda city sub urban division, Mansa division, Maur division, Budhlada division, BhagtaBhaika division, Faridkot division, Kotkapur division, Moga City division, Moga sub urban division,, Baghapur division, Ferozepur City division, Ferozepur sub urban circles Jalandhar division, Zira division, Madout division, Gidarbha division, Muktsar division, Abohar division, Fazilka division, Badal division (21 No's)	

Zone	Circle	Division	Subdivisions
5. Central	Khanna, Ludhiyana East, Ludhiyana Sub urban, Ludhiyana West sub urban, (4 Nos)	Srihud Division, Khana Division, Doraha Division, Govindgarh Division, Amloh Division, City Central Ludhiana Division, Focal Point Ludhiyana Division, CMC Division Ludhiyana, Slider Nagar Ludhiyana Division, Ahmadgarh Division, Laltonkalan Division Ludhiyana, AddaDakha Division Ludhiyana, Jagraon Division, Raikit Division, West DivisonLudhiyana, JantannagarLudhiyana Division, Model Town Ludhiyana Division, East Division Ludhiyana Circle, Agara Nagar Ludhiyana Division 19 Nos	

3.2.1. PSPCL consumers of different categories

So, PSPCL provides energy to consumers of different categories, 10513759 numbers at 0.440 KV, 11 KV and some consumers at 66 KV also (Example M.E.S.). The infrastructure involved in distribution of energy are having 13148 numbers of 11 KV Feeders, 1200300 DTs (11 KV/0.44 KV), Power Transformer 1420 numbers (66 KV/11 KV or 66 KV/33 KV). The network has embedded Solar Power of 240.46 MU (From intrastate sources at 11 KV) and Solar Power under net metering scheme to a tune of 101.91 MU.

Source	Energy availability at the boundary	% of Energy
1. Intrastate	33261.97	48.28%
2. Interstate	35386.59 (Including PSPCL + PSTCL Loss)	51.36%
3. Solar Power	240.46	0.348%
Net Total	68889.03	100%
4. PSPCL + PSTCL (T&D Loss)	2728	3.96%
5. Net Energy available for use	66160.34 MU	

The management of surplus power is being made through Banking, 311.80 MU and through unscheduled interchange of 441 MU (Means exporting 441 MU to regional pool account by drawing less energy than schedule due to its low demand and fetching revenue to reduce the cost of energy purchased from interstate source).

PSPCL is having one no. of GIS at Ludhiana known as GT Road Subdivision, due to paucity of land in heart of city, to cater industrial load.

The line length of 66 KV and 11 KV, LT lines are very short and hence it helps in reducing line losses. LT lines of 440 Volts supply after Distribution Transformer too are very short and average length is 1 KM. So this helps in keeping T&D loss low. The loss of transmission in PSTCL lines (400 KV, 220 KV, and 132 KV and its busses) and PSPCL lines (66 KV busses and Transformers) stands to be 3.96% energy at state boundary. It is well within the normal range of loss considering the voltage level involved. The net input energy available at PSPCL boundary is 66160.34 MU and actual energy sold is 58708.60 MU. So, technical loss in 11 KV lines, 440 volt LT lines along with theft stands to be 7451.75 MU (11.26% of input energy available at boundary of PSPCL)

3.3. Profile of Punjab State Electricity Board

Earlier Punjab state electricity Board was in existence before 2010 but after its unbundling, PSPCL (Punjab state Power Corporation Limited) came into existence. It was incorporated as company on 16th April 2010. It bears the responsibility of generation and distribution of power. The network configuration and its authority is as mentioned below

- 400 KV, 220 KV and 132 KV Transmission of Power up to 132/66 KV G/S/S → TRANSCO.
- Distribution of Power of 66 KV/11 KV, 33 KV and 11 KV either through 66 KV/11 KV Power transformers or 11 KV/0.415 KV DT → PSPCL.
- Energy billing to consumer at 66 KV, 11 KV and 0.415 → PSPCL.

Metering of energy is through communicable, non communicable, smart meters (Prepaid), AMR/SMART meter etc.

DTs are not having receiving meters at the incoming or at outgoing of it. So, the network losses assessment at 66 KV and 11 KV Feeders are not possible right now, until and unless all the input, output of DT, 11 KV feeders, Power transformer and 66 KV lines are provided with communicable meters (AMR/SMART Preferably).

- **Energy billing is being done by Accounts wing of PSPCL. SAP system is functioning at Head Quarter which fetches sub division-wise data of different category of consumers through AMR/SMART meter or communicable meter data by downloading through handheld machines. So, they are fetching energy data of energy meters of consumers and getting processed at SAP Center.**

Mandatory Audit Detail Of PSPCL

- Each substation is having dedicated feeder of 11 KV to different categories. The industrial consumers have installed the capacitor banks at their interface of connection. Apart from industrial feeders power substation is also having Capacitor Bank installed with bus bar to meet reactive power requirement of the other categories.
- The line length of 66 KV and 11 KV lines are very short. So, T&D losses are very low. The voltage variation of bus voltage is around 4-5%. Bus loss varies from 0.25% to 0.98 % (max). This indicates that load profile of bus bar is of varying nature.
- Agricultural feeders are provided power for 8 hours in a day with shift rotation of each agricultural feeder. Agricultural consumers are provided 100% subsidy and are not metered.

4. PSPCL Network

4.1. Power Flow Chart of PSPCL Network

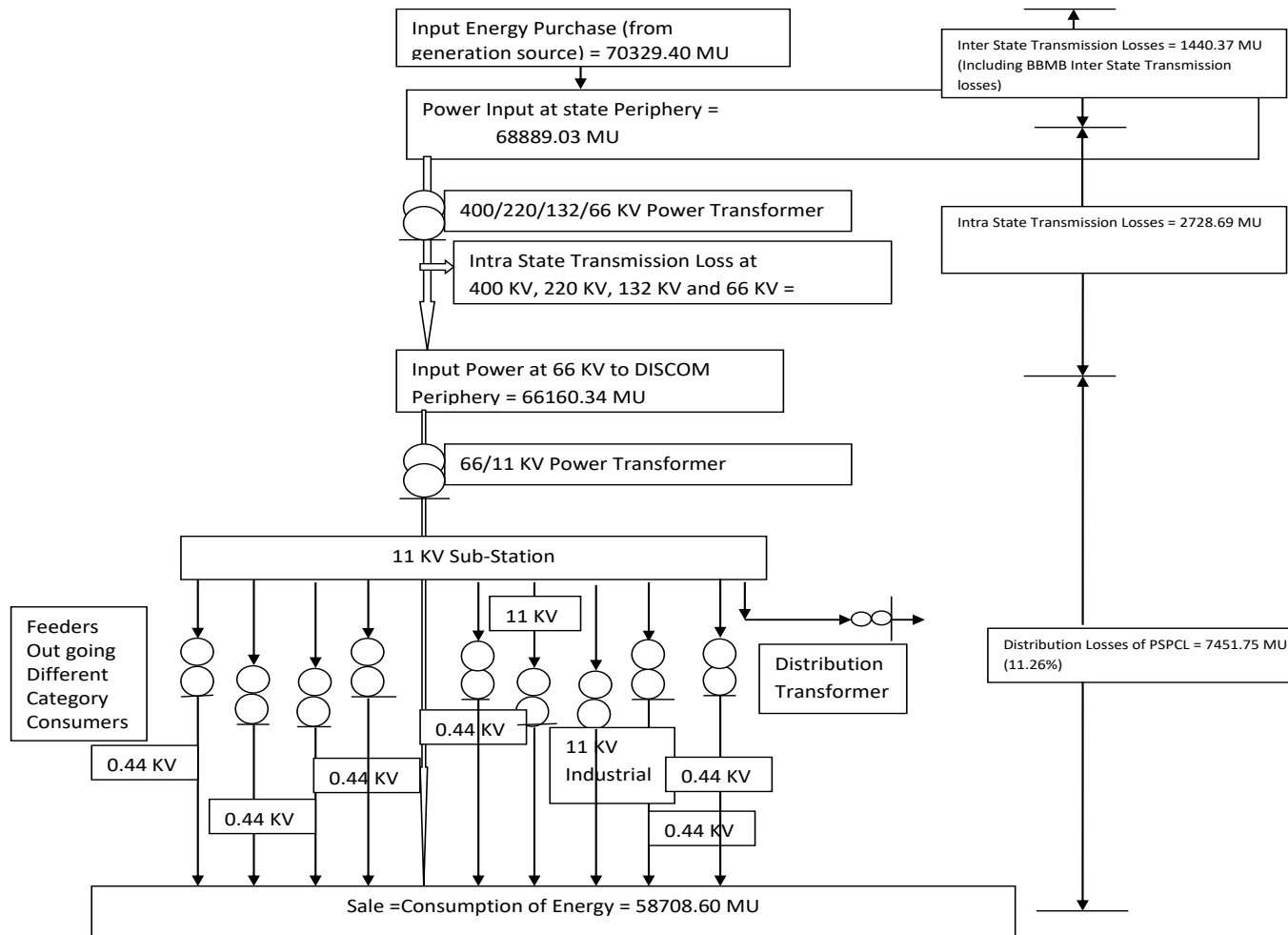

4.2. Metering and Billing arrangement

The Energy Meters are installed at the sending end of 66KV sub transmission lines. But 66 KV lines feeding to consumers of 66 KV have meters in both end of the line. But such lines are very few in number. Power transformers of 66 KV/11 KV substations have energy meters in receiving end (Input) of bus bar. DT installed at the consumer end in the 11 KV Feeders do not have any input meter. Most of the energy used is subsidized. PSPCL has the logic to meter the consumption of energy by different categories being fed through 11 KV dedicated feeders. Agricultural are availing 100% subsidized energy. So, they are being provided 8 Hours power out of 24 Hours (3 shifts of rotation of agricultural feeders in a day). The detail of meter types is given below (From 4.1 Form-Details of Input Infrastructure)

	Types of meter	66 KV Category (231 Nos)	%	33 KV	%	Consumption 11 KV (16931 Nos)	%	Consumer LT (10496182)	%
Consumer 231	Non communicable	31	13.41	0	0	7511	44.36	7872441	75
	Non Smart Pre Paid	4	0	3	50	47572	10.14	1064582	1.33
	Smart Meter (Non Prepaid)	-	-	-	-	114	0.67	140038	0.013
	Smart Meter Prepaid	-	-	-	-	-	-	1416	0.54
	AMR/SMART Meters	196	86.59	3	50	8831	52.15	3567	13.17
	Nos of unmetered Consumer	-	-	-	-	-	-	1382434	-
DT 1420 Ng	Non communicable	-	-	-	-	25943	2.16	0	-
	Communicable Meters	1420	100	2	100	33754	9.81	-	-
	Unmetered	0	-	-	-	1140603	95	0	-
Feeders	Nos	168	-	5	-	12975	-	-	-
	Communicable Meter	168	100	5	100	12975	100	0	0
	Unmetered	0	0	0	0	0	0	0	0

The billing responsibility of consumers lies with account wing of PSPCL. Energy data from consumers reach to SAP at Head Quarter, Patiala directly through AMR/SMART meters or through communicable meters by downloading through hand held machine and being processed by installed software.

4.3. Category of Feeders

Category of feeders is referenced from Electricity Supply Instruction manual 2018, Page -9

1. Category 1 – Urban industrial feeders

The feeders which are feeding mixed load of domestic, commercial, industrial consumers including arc/induction furnaces and essentials industries fed through mixed feeders.

2. Category 2 – (11 KV/33 KV /66 KV /132 KV /220 KV separate and independent feeders)

- i) 11 KV /33 KV /66 KV /132 KV /220 KV separate/independent feeders of consumer which have not been declared.
- ii) The mixed industrial feeders having sanctioned industrial load of 90% or more of the total connected load on feeders.

3. Category 3 – Arc/Industrial furnace consumers fed through separate/independent feeders. Feeding only to Arc/Industrial furnace consumers.

4. Category 4 - Separate/Independent feeders of those consumers continuous process/essential industries which have been declared as Continuous process/Essential industries.

5. Category 5 – 24 hours urban pattern supply 3 Phase &3 wire feeders. This category shall cover all the 11 KV 3 phase 3 wires feeders erected to give 24 hour supply on urban pattern to village.

4.4. Scope of Work of MEA

The Scope of the study for annual energy audit of PSPCL for AT&C losses for the FY 2022-23 is as follows:

- I. Energy Audit was carried out in the line of regulations.
- II. Preparation of checklist/action plan for Energy Audit.
- III. Performa of energy audit was shared with selected agency after the issue of work order. DISCOM visit was carried out by all team members of the agency as per the team declaration in technical proposal. Energy Audit regulation 2021 Performa has been used for this audit.
- IV. Collection and Review of the energy related data of Financial Year i.e. FY: 2022 – 2023.
- V. Verification of existing system of energy distribution across periphery of Electricity Distribution Company.
- VI. Collection and verification of energy flow data of electricity distribution company at all applicable voltage level of distribution network based on the details presented by PSPCL.

- VII. Collection of data on energy received and distributed by DISCOM i.e. PSPCL and verify the accuracy of data.
- VIII. Collection and analysis of data and preparation of reports.
- IX. Observation and compilation of various Energy Conservation (ENCON) options implemented by DISCOM i.e. PSPCL along with preparation of report containing details of expenditure made by Designated Consumer i.e. PSPCL.
- X. Recommendations to facilitate energy audit, energy accounting and improve energy efficiency.
- XI. Current system metering status at various voltage level of DISCOM i.e. PSPCL.
- XII. Status of functional meters for all consumer transformer and feeders.
- XIII. Status of default meters for all consumers transformers and feeders.
- XIV. Current status of pre-requisite mentioned in regulation.
- XV. Copies of relevant authentic and certified document supporting the report.
- XVI. Prepare final report of DISCOM i.e. PSPCL as per the scope of work and as per the regulation of energy audit, in a standard format dully indexed, covering of the unit and its details of energy related data with respect to PSPCL along with analytical and statistical details.

5. Notification and Category of Consumers

5.1. Category of Consumers

Following category of consumers are being fed power with different priority according to nature of the job, subsidy allowed, production nature and general purpose of lighting consideration.

- i) Domestic Supply - DS
- ii) Commercial Supply - CS
- iii) Small Power Supply - less than 20 KW load (SPS)
- iv) Medium Power Supply - More than 20 KW and less than 100 KW load (MPS)
- v) Large Power Supply - more than 100 KW load (LPS)
- vi) Agriculture Purpose - 8 hour power supply in 24 hours because 100% subsidized.

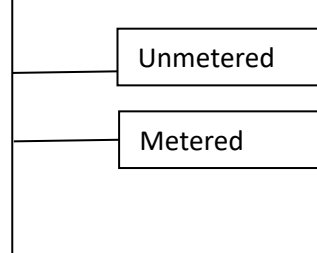

SPS + AP = Domestic Industries

- vii) Bulk Supply - Power given to different society (Group of consumers)

- viii) Railway Supply

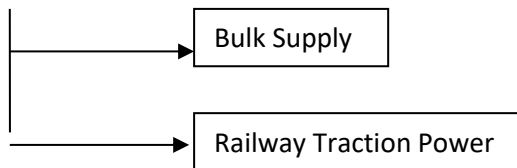

- ix) Public Lighting - PL (Street Lighting)

5.2. Provisions of subsidy

Government of Punjab has notified subsidy for agriculture sector and other deprived section of the society and poor people of general category in the following manner. (Reference from Annexure – 14 (Notification of Government for subsidy))

Sr No.	Category	Provision of subsidy/Payment
1	Agriculture Sector	100 %
2	Schedule Cast (SC), Non –SC BPL, Backward Class (BC) and freedom fighter domestic consumers	300 units monthly
2.a.	Excess over 300 Limit/Months by them	Liable to pay for extra unit consumed over 300 Limit/Month as per applicable slab of tariff with full fixed charge and meter rental.
2.b.	Subsidy payment conditions	Up to 300 unit/month for all kind of use.
3	General Category (other domestic consumers)	300 unit/month
3.a.	Subsidy Condition	For residential use only with full fixed charge and meter rent.
3.b.	In excess over 300 unit/month	Liable to pay for entire consumption as per applicable slab of tariff along with fixed charges, Meter Rentals and Government Levies.
4	All domestic consumers having Sanctioned Load up to 7 KW	Rs 3/Unit (including taxes)
5	All industrial manufacturing and LT & ITES industries and industrial parks and amusement parks/Adventure parks developed in minimum area of acres dully registered with Department of Tourism.	Subsidized Tariff Rs 5.50 per Kwh with 3% annual escalation.
6	Small scale industries	Charged at subsidized rate of Rs 5.5/Kwh with 3% annual increment and full waiver of fixed charges.
7	Medium scale industries	Charged as subsidized rate of Rs 5.5/Kwh with 3% annual escalation and 50 % waiver IN fixed charges.
8	Large supply industrial consumption	Charged as subsidized rate of Rs 5.5/Kwh with 3% annual escalation.
9	Central/State/PSUs/PSPCL/PSTCL/BBMB offices and Government water supply connections under industrial category (SP/MS/LS)	No subsidy allowed.

5.3. Policy for calibration of Meters

Central Electricity authority vide notification no 502/70/CEA/DP & D, in exercise of powers conferred by sub section (1) of section 55 and clause (e) of section 73 read with sub section 177 of Electricity Act, 2003 made regulation known as the Central Electricity Authority (Installation and operation of meter is cited below for ready reference

- 18.b. All interface meters shall be tested at least once in five years. These meters shall also be tested whenever the energy and other quantities recorded by the meter are abnormal or inconsistent with electrically adjacent meters. Whenever there is unreasonable difference between the quantity recorded by interface meter and the corresponding value monitored at the billing center via communication network, the communication system and terminal equipment shall be tested and rectified. The meters may be tested using NABL accredited mobile laboratory or at any accredited laboratory and recalibrated if required at manufacturer's works.
- 18.c Testing and calibration of interface meters may be carried out in the presence of the representatives of the supplier and buyer. The owner of the meter shall send advance notice to the other party regarding the date of testing.
- 18.(2) **Consumer meters:** The testing of consumer meters shall be done at site at least once in five years. The licensee may instead of testing the meter at site can remove the meter and replace the same by a tested meter duly tested in an accredited test laboratory. In addition, meters installed in the circuit shall be tested if study of consumption pattern changes drastically from the similar months or season of the previous years or if there is consumer's complaint pertaining to a meter. The standard reference meter of better accuracy class than the meter under test shall be used for site testing of consumer meters up to 650 volts. The testing for consumers meters above 650 volts should cover the entire metering system including CTs, VTs. Testing may be carried out through NABL accredited mobile laboratory using secondary injection kit, measuring unit and phantom loading or at any accredited test laboratory and recalibrated if required at manufacturer's works.
- 18.(3) **Energy accounting and audit meters:** Energy accounting and audit meters shall be tested at site at least once in five years or whenever the accuracy is suspected or whenever the readings are inconsistent with the readings of other meters, e.g., check meters, standby meters. The testing must be carried out without removing the CTs and VTs connection. Testing may be carried out through NABL accredited mobile laboratory using secondary injection kit, measuring unit and phantom loading or at any accredited test laboratory and recalibrated if required at manufacturer's works.

5.4. Comment:

But there is general practice to change the meter in case erratic reading is observed. Manpower needed for testing of LT meter, DTs meter, and Feeder meter through NABL across the country is not adequate to take up the work regularly at 5 years on call of DISCOM. But in place of such non

Mandatory Audit Detail Of PSPCL

feasible provisions DISCOM's meter readers reads the energy consumption/download consumption and observe the functioning of meters. They report about the meters to the department looking after metering. Meter are tested and calibrated before installation but thereafter there is system of regular calibration by NABL at every 5 Years interval. Each zone has ME (Meter Equipment) labs for testing and calibrating the meter before installation of new meter or replacement of defective meters.

6. Energy Audit of PSPCL

6.1. Methodology for Energy Audit FY 2022-2023

M/S KESPL has been awarded the work of Mandatory Energy Audit for FY 2022-2023 by PSPCL vide w.o. no 002/DSM dated 09-05-2023. The objective is to conduct energy audit of PSPCL Distribution Network, energy flow, metering, billing and collection performance assessment based on data submitted for study. The approval and methodology are as mentioned below

1) Kick off Meeting(Pre-Audit Phase)

- Introduction of stakeholders with Audit Team.
- Sharing contact details of team members and identify the lead managers (Energy Manager/Nodal officer) for the audit.
- Sharing details regarding project in respect of BEE PAT Scheme.
- Discussion regarding approach of study.
- Over all project plan
- Identification of boundaries of audit.

2) Data collection for FY 2022-2023(Audit Phase)

- Details of purchase of energy
- Details of subsidy
- Details for approved energy for sale by state regulatory commission
- Energy flow details and check
 - i) Energy flow between transmission and 66 KV/33 KV/11 KV incoming distribution feeders
 - ii) Energy flow between 66 KV/33 KV outgoing and 11 KV incoming feeders
 - iii) Energy flow between 11 KV feeders and Distribution Transformers or high voltage distribution systems.
 - iv) Energy flow between DT or high voltage distribution system to end consumer including ring main system.
 - v) Energy flow between feeders to end consumers.
 - vi) Energy flow between 66 KV/33 KV/11 KV directly to consumers.
- Identification and mapping of network assets.
- Capacity-wise HT and LT Transformers
- HT & LT Energy meter
- Mapping of HT and LT Consumers including open access
- Mapping of type of meter and functionality status.
- System of generating energy account

- Verify the accuracy of data collected in consultation with nodal officer of the DISCOM company as per standard practices and validation of data compared to collected data and analysis with respect to
 - i) consistency
 - ii) recommendation to facilitate energy accounting
 - iii) Assessment of energy conservation measures adopted by DISCOM

3) Preparation of energy audit report covering (Post Audit Phase))

- Power Input source at different voltage levels
- Total Input Energy
- LT & HT Distribution Network Configuration
- Metering Details, Type, Metered & Unmetered
- Record Keeping, Accountability, Monitoring & Verification Procedure
- T& D Losses
- Measures taken by DISCOM to improve transmission efficiency including prevention of theft.
- Impact of Solar Power generation and net metering.
- Input of stakeholders including substation level management personnel.

6.2. Methods of data collection

Sample check of meter installed in various sub-station were carried out during field visit of audit team. The problems regarding calculation of feeder-wise losses were observed. Loss assessments of bus bars along with power transformers at 66 KV/11 KV substations were noted. Type of meters and its functional status were verified. Following data have been obtained for analysis. The analysis of energy audit is based on the information contained in the report as mentioned below

- 1) Performa for quarterly consumer category wise subsidy bill/received/Due for the period 2022-2023.
- 2) Abstract of BEE formulas FY 2022 – 23
- 3) Detailed collection efficiency up to Q4 , 2022 – 23 (As per formats)
- 4) General information sheet
- 5) Details of input infrastructure
- 6) A list of questionnaires given to PSPCL regarding activities to be performed as per BEE norms and its possibility of fulfilment.
- 7) List of division-wise and category-wise loss assessment.
- 8) Notification of government regarding subsidy.
- 9) Division-wise loss assessment sheets.

6.3. Analysis of Data Collected for Determining of Billing and collection efficiency

Sr No.	Description	Symbol	Value
1.	Input Energy = (Import – Export)	Ei	66160.34 MU
2.a)	Energy Billed (Metered)	E1	58708.60 MU
2.b)	Energy Billed (Un Metered)	E2	0
2.c)	Total Energy Unit Billed (E1+E2)	Eb	58708.60 MU
3.	Amount Billed	Ab	37130.30 Cr
4.	Gross amount Collected Ag = (As+Ans)	Ag	41743.16 Cr
4.a)	Subsidy Amount Billed	As	16434.46 Cr
4.b)	Non Subsidy Amount Billed	Ans	20695.84 Cr
5.	Billing Efficiency	Eb/Ei 100	89.34 %
6.	Collection efficiency	CE	100 %
7.	{1 - (BE.CE) X 100	(1 -0.8934X1) X 100 = (1-0.8934) X 100 =0.1066	11.26%
8.	AT&C Loss		11.26%

7. Performance Assessment of PSPCL

7.1. Performance Assessment

Following comes under the infrastructure of PSPCL (reference 4.1 Details of Input infrastructure)

7.1.1. Feeders

No of Feeders	Voltage level	Total CKT Length	Average Length per Feeder	Remarks
168	66 KV	14289 KM	28.35 KM	Appropriate Length
5	33 KV	71 KM	4.73 KM	Appropriate Length
12975	11 KV	252006 KM	6.47 KM	Appropriate Length

7.1.2. Meters (For Consumers 66 KV)

	Types of Meter	Voltage Level	% of meter	33 KV %	11 KV %	LT%
	Non communicable	-	13.41	-	44.36	75
Communicable	AMR/SMART Meter	-	86.59	50	52.15	0.34
	Smart Meter (Non Prepaid)	-	-	-	0.67	1.33
	Smart Meter (Prepaid)	-	-	-	-	0.013
	Non Smart Prepaid	-	-	50	2.8	10.14
	Unmetered	-	-	-	-	13.17

Among LT meters 75% are non communicable and 13.17% are unmetered. So PSPCL needs to improve in providing AMR/SMART and communicable meters to all consumers. In 11 KV Consumers, 44.36% meters are non communicable.

7.1.3. Feeder Meters

Voltage in KV	Nos of Feeder	Nos of communicable meter	% Meter	Remarks
66	168	168	50	Since one end is metered
11	12975	12975	50	Since one end is metered

Comment: PSPCL must provide metering in both ends of the lines in order to assess Line Losses of each line.

7.1.4. Transformer Meter

Voltage	No of Transformers	%	No of communicable Meter	%	Non Communicable	%	Unmetered	%
66 KV	1420	-	1420	-	0	0	0	-
33 KV	2	-	0	-	-	-	-	-
11 KV	1200300	2.8	33754	2.16	25943	2.16	1140603	95

Comment: Distribution Transformers are 95% unmetered. So, it is not possible to calculate line loss as per BEE guidelines. In case of 66 KV transformers too only one side of transformer is metered. So transformer loss of each transformer is not possible to calculate. So PSPCL has to install AMR/SMART meters in unmetered consumer, DTs, Feeders, and Transformers in order to comply the guidelines of BEE.

➤ RPO (Renewable purchase obligation)

The verdict of Punjab state electricity regulatory commission in petition number 30 of 2022 Dt. 06-01-2023 has allowed PSPCL to carry forward the deficit target of RPO of FY 2021-22 and 2022-23 to FY 2023-24.

As per present target and provisions for RPO PSPCL is hoping to be surplus in respect of RPO. The new provisions for RPO consideration is in favor of PSPCL.

➤ Provisions for RPO

- 1) The energy from the Large Hydropower Projects (LHPs) including Pump Storage Project (PSPs) having capacity more than 25 MW and commissioned after 8th march 2019 will be considered as RPO, notified nomenclature as HPO.
- 2) From FY 2022-23 onwards the energy from all Hydropower Projects (HPPs) will be considered as part of RPO. All other HPPs will be considered as part of RPO under category of 'Other RPO'

RPO Trajectory for the period 2021 – 22 to 2029 – 30

Year	Wind RPO in %	HPO in %	Other RPO in %	Total RPO in %
2022-23	0.81	0.35	23.44	24.61
2023-24	1.60	0.66	24.81	27.08
2024-25	2.46	1.08	26.37	29.91
2025-26	3.36	1.48	28.17	33.01

Year	Wind RPO in %	HPO in %	Other RPO in %	Total RPO in %
2026-27	4.29	1.80	29.86	35.95
2027-28	5.23	2.15	31.43	38.81
2028-29	6.16	2.51	32.69	41.36
2029-30	6.94	2.82	33.57	43.39

Now PSPCL after the inclusion of all the existing hydro energy from state share of Bhakhra Nangal project as category ‘Other RPO’ will exceed its RPO target.

7.1.5. Technical Setup for online monitoring

Most of the meters are non communicable (75%) and 13.17% are unmetered. So, infrastructure for online monitoring is missing the basic requirement of online monitoring. It is required to have AMR/SMART meters installed at different voltage level to facilitate verification of accounted energy flow of the distribution network. (Refrence 4.1 Form-Details of Input Infrastructure)

- i. Energy flow between Transmission and 66 KV/33 KV/11 KV incoming distribution feeders.
- ii. Energy flow between Transmission and 66 KV/33 KV/11 KV outgoing and 11 KV/66 KV incoming feeders.
- iii. Energy flow between 11 KV /66 KV feeders and distribution transformers or high voltage distribution system.
- iv. Energy flow between DT or high voltage distribution system to end consumer including ring main system.
- v. Energy flow between feeder to end consumer
- vi. Energy flow between 66 KV/33 KV/11 KV directly to consumers.

Therefore, it is mandatory to have all the meters of AMR/SMART type or communicating type. All the consumers should be tagged to feeding DT (in LT Category) or feeders in case directly fed at higher voltage to other industrial category. DT to be tagged with feeders. Feeders are to be tagged with power transformers. Power transformers to be tagged with incoming Sub-transmission lines. Incoming line energy meters are to be tagged with Grid Substation. PSPCL have to make elaborate arrangement of online monitoring in order to be aligned with BEE norms.

7.1.6. Reactive Power Management

Reactive power requirement by industrial consumer has to be made by installation of capacitor bank at the load point. Further requirement of reactive power to other category is being met by installing capacitor bank in the bus (with Local control and remote control facility). Therefore, it is good to avoid reactive power transportation from high voltage side. PSPCL has managed voltage variation between 4.5 to 5%.

The bus losses including power transformer (66/11 KV) is varying between 0.25 to 0.98%. This shows that there is wide variation of load during 24 hours.

7.1.7. Loss % Zone-wise/Circle-wise

				Loss Percentage (in %)					
Zone	Name of Cities	Numbers of Division	0-10	10-15	15-20	20-30	30-40	40-48	
Border	City Amritsar	3			3				
	Gurudaspur	4			2	2			
	Suburban Amritsar	5			2		3		
	Taran Taran	5			1	1	1	2	
	Hoshiarpur	1					1		
North	Nawanshahar	1	54	18		1			
South	Barnala	2			1	1			
	Sangrur	2				2			
West	Bathinda	2				2			
	FaridKot	1				1			
	Ferozpur	3				1	2		
	Mukatsar	3				2	1		
Total	4	12	32		9	14	7	2	
Total nos of Substations	5	21	104						

7.2. Graph Of Losses

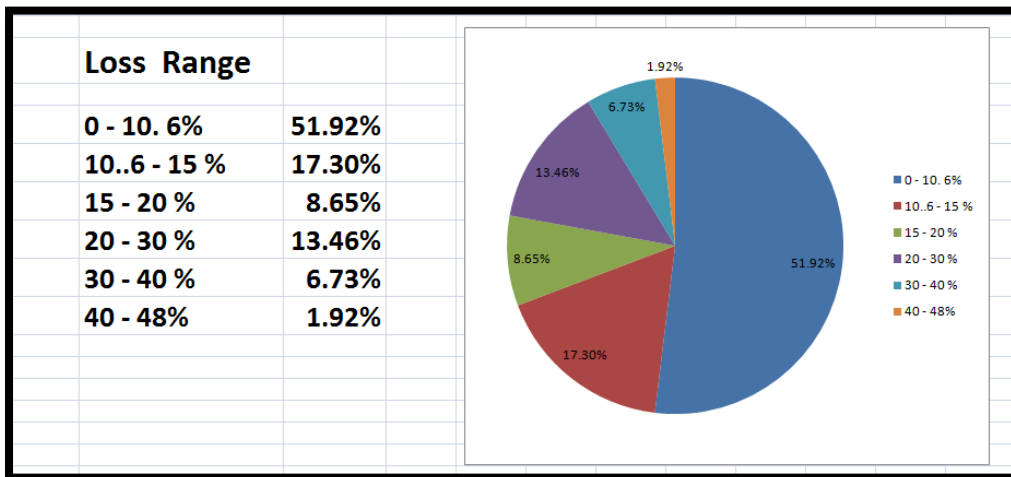

Maximum loss in Tarn Taran circle of Border Zone in division Bhikhiwindi and Patti have been observed as 48.54% and 42.54% respectively. Further maximum number of divisions of Border zone are showing more losses in 17 Divisions out of 32 Divisions identified from all the Zones falling under range of losses from (15-20), (20-30), (30-40), (40-50) percent.

So Border Zone Divisions under different circles are identified as area of maximum T&D Loss.

8. Recommendations

- 1) Replacement of conventional meter with the communicable meters.
- 2) Installation of communicable meter outside the end user consumers premises (100% metering).
- 3) Ensure Communicable Meters (AMR/SMART) at the input of DT (Receiving end of 11 KV Feeders).
- 4) Install Communicable Meters (AMR/SMART) in the outgoing 11 KV Feeders.
- 5) Install Communicable Meters (AMR/SMART) at the receiving end of 66 KV Sub-transmission lines.
- 6) Zone-wise Data Center should be formed.
- 7) Focus should be on adding more Solar Power in the network at 11 KV and net metering growth in future.
- 8) Maintain separate Energy Account like billing, collection under head subsidized and nonsubsidized to make the calculation simple and reflecting respective efficiency.
- 9) Energy recording of meter should be time synchronized. This could be possible only with communicable meters, in which energy recording is time stamped by GPS clock inbuilt system. So manual recording and non communicable meters may not be useful to prepare loss account of various feeders (66 KV, 33 KV & 11 KV) and DTs.
- 10) In order to match the total consumption by end user consumers with DT, there must be tagging of consumers with feeding DTs. Again DTs must be tagged with 11 KV feeders. 11 KV Feeders must be tagged with Power Transformers. Power Transformers must be tagged with 66KV sub-Transmission lines. Each 66 KV lines must be tagged with Grid Sub Station. Such arrangements are required to comply the BEE norms of Network monitoring at various voltage levels and Feeder-wise.
- 11) Particularly in industrial loads, observe Load Profile. If there is variation in load of induction motor, insist them to install VFD (Variable Frequency Drive) to reduce consumption of Power
- 12) In agriculture, most of the pumps is inefficient and consumes excess power. So VFD in Pump or replacement of inefficient pump should be encouraged.
- 13) The use of energy efficient fans, centrifugal pump and induction motors for saving of energy must be promoted in the fashion like LED bulb distribution was made by DISCOM to the consumers under massive campaign.
- 14) Ensure 100% Metering of Agriculture consumers (1382434 Non Metered). In case of no subsidy, the metering of used energy by individual consumer will be mandatory for preparation of actual energy bill.

Mandatory Audit Detail Of PSPCL

1. Maximum loss making area of Border Zone need special attention to control theft of power by use of Aerial bunch/covered conductor to avoid hooking and theft of power through small transformer of 11 KV/0.44 KV [Easily Available in market].
2. Mission for providing meter connection through camp campaign should be started in order to avoid theft by illegal persons.
3. Ensure use of star rated pumps , used in agriculture by farmers.
4. Ensure use of distribution transformers in future having core of amorphous material in place of traditional core of silicon alloyed iron core. This will save 70 % of core loss.
5. Use star rated distribution transformers under standard and labeling program.
6. Opting use of lower resistance All Aluminum Alloy Conductors (AAAC) in place of conventional cored steel Reinforced (ACSR) lines.
7. Minimize Losses due to weak links in network such as jumpers, loose contacts and brittle conductors.
8. Commercial losses are reported due to meter reading problems. Meter reading is deprived on account of locked premises, untraceable consumers, stock/defective meters and temporary disconnected consumer. So meter should be place outside the premise at the nearest pole. This will also help in check of theft by meter bypassing or tampering of meters.
9. Theft prone area and maximum loss of energy area must be on the radar of vigilance squad.

9. List of abbreviations

Sr. No.	Short Form	Abbreviation
1	EHV	Extra High Voltage
2	EHT	Extra High Tension
3	FY	Financial Year
4	I&C	Installation and commissioning
5	ICL	Incandescent Lamp
6	IPP	Independent Power Plant
7	KVA	Kilo Volt Ampere
8	KVAR	Kilo Volt Ampere Reactive
9	MOP	Ministry of Power
10	MVAR	Mega Volt Ampere Reactive
11	M&V	Monitoring and Verification
12	MU	Million Units (Million KWG)
13	MVA	Mega Volt Ampere
14	MVA _r	Mega Volt Ampere Reactive
15	MMC	Monthly Minimum Charges
16	MTOE	Million Ton Oil Equivalent
17	NRSE	New and renewable Source of Energy
18	PF	Power Factor
19	PT	Power Transformer (Ref CT-PT Ratio)
20	POC	Point of Connection
21	HT	High Tension Line
22	kW	Kilo Watt
23	kWH	Kilo Watt Hour
24	LED	Light Emitting Diode
25	LT	Low Tension Line
26	PSPCL	Punjab state Power Corporation Limited
27	PSTCL	Punjab state Transmission Corporation Limited
28	PEDA	Punjab Electricity Development Agency

Sr. No.	Short Form	Abbreviation
29	SLD	Single Line Diagram along with input energy
30	SLDC	State Load Dispatch Center
31	T&D	Transmission and Distribution
32	UJALA	UnnatJyoti Affordable lighting for All
33	UPS	Uninterrupted Power Supply
34	1000 M kWh	86, 000 MToe
35	AEA	Accredited Energy Auditor
36	ABR	Average Billing Rate
37	ABC	Aerial Bunched Cables
38	AP	Agricultural Pump
39	Amp	Ampere
40	AMI	Advanced Metering Infrastructure
41	AMR/SMART	Automated Meter Reading
42	AMR/SMARTUT	Atal Mission for Rejuvenation and Urban Transformation
43	AT&C	Aggregate Technical and commercial
44	BBMB	Bhakra Beas Management Board
45	BEE	Bureau of Energy Efficiency
46	CEA	Certified Energy Auditor
47	CERC	Central Electricity Regulatory commission (India)
48	CFL	Compact Florescent Lamp
49	CO ₂	Carbon Dioxide
50	CKT	Circuit Kilometer
51	CT	Circuit Transformer (Ref. CT-PT Ratio)
52	DC	Designated Consumer
53	DCS	Distributed Control system
54	DT	Distribution Transformer
55	EAR	Energy Audit Report
56	EmAEA	Empanelled Accredited Energy Auditor
57	EC	Energy Conservation
58	ECM	Energy Conservation Measures
59	EE	Energy Efficiency
60	EPIA	Energy Performance Improvement Action

General Information

1	Name of the DISCOM	Punjab State Power Corporation Limited (PSPCL)		
2	i) Year of Establishment	2010		
	ii) Government/Public/Private	Government		
3	DISCOM's Contact details & Address			
i	City/Town/Village	Patiala		
ii	District	Patiala		
iii	State	Punjab	Pin	147001
iv	Telephone	0175-2212005	Fax	0175-2213199
4	Registered Office			
i	Company's Chief Executive Name	Er. Baldev Singh Sran		
ii	Designation	CMD PSPCL		
iii	Address	The Mall, Patiala		
iv	City/Town/Village	Patiala	P.O.	Patiala
v	District	Patiala		
vi	State	Punjab	Pin	147001
vii	Telephone	0175-2212005	Fax	0175-2213199
5	Nodal Officer Details*			
i	Nodal Officer Name (Designated at DISCOM's)	Er. Hira Lal Goyal		
ii	Designation	Chief Engineer (Energy Audit & Enforcement)		
iii	Address	Shed No. B2, Shakti Vihar, Patiala		
iv	City/Town/Village	Patiala	P.O.	Patiala
v	District	Patiala		
vi	State	Punjab	Pin	147001
vii	Telephone	0175-2215774	Fax	0175-2215774
6	Energy Manager Details*			
i	Name	Er. Ravi Verma		
ii	Designation	ASE	Whether EA or EM	EA
iii	EA/EM Registration No.	EA-7969		
iv	Telephone		Fax	
v	Mobile	96461 21187	E-mail ID	ivarverma76@gmail.com
7	Period of Information			
	Year of (FY) information including Date and Month (Start & End)	1 APRIL 2022 - 31 March 2023		

Performance Summary of Electricity Distribution Companies			
1	Period of Information Year of (FY) information including Date and Month (Start & End)	1 APRIL 2022 - 31 March 2023	
2	Technical Details		
(a)	Energy Input Details		
(i)	Input Energy Purchase (From Generation Source)	Million kwh	70329.40
(ii)	Net input energy (at DISCOM Periphery after adjusting the transmission losses and energy traded)	Million kwh	66160.34
(iii)	Total Energy billed (is the Net energy billed, adjusted for energy traded))	Million kwh	58708.60
(b)	Transmission and Distribution (T&D) loss Details	Million kwh	7451.75
		%	11.26%
	Collection Efficiency	%	100%
(c)	Aggregate Technical & Commercial Loss	%	11.26%

Discom D Losses

I/We undertake that the information supplied in this Document and Pro-forma is accurate to the best of my knowledge and if any of the information supplied is found to be incorrect and such information result into loss to the Central Government or State Government or any of the authority under them or any other person affected, I/we undertake to indemnify such loss.

Authorised Signatory and Seal

Signature:-

Name of Energy Manager*:

Registration Number:

Name of Authorised Signatory

Name of the DISCOM:

Full Address:-

Seal

Form-Details of Input Infrastructure

1	Parameters	Total	Covered during in audit	Verified by Auditor in Sample Check	Remarks (Source of data)
i	Number of circles	21	21	21	CE/Planning
ii	Number of divisions	104	104	104	CE/Planning
iii	Number of sub-divisions	508	508	508	CE/Planning
iv	Number of feeders	13148	13148	13148	Director / D
v	Number of DTs	1200300	1200300	1200300	Director / D
vi	Number of consumers	10513750	10513750	10513750	CE/Planning
2	Parameters	66kV and above	33kV	11/22kV	LT
a. i.	Number of conventional metered consumers	31	0	7511	7872441
ii	Number of consumers with 'smart' meters	0	0	114	140038
iii	Number of consumers with 'smart prepaid' meters	0	0	0	1416
iv	Number of consumers with 'AMR' meters	196	3	8831	35671
v	Number of consumers with 'non-smart prepaid' meters	4	3	475	1064582
vi	Number of unmetered consumers	0	0	0	1382434
vii	Number of total consumers	231	6	16931	10496582
b.i.	Number of conventionally metered Distribution Transformers	0	0	25943	0
ii	Number of DTs with communicable meters	1420	2	33754	0
iii	Number of unmetered DTs	0	0	1140603	0
iv	Number of total Transformers	1420	2	1200300	0
c.i.	Number of metered feeders	168	5	12975	0
ii	Number of feeders with communicable meters	168	5	12975	0
iii	Number of unmetered feeders	0	0	0	0
iv	Number of total feeders	168	5	12975	0
d.	Line length (ct km)	14289 KM,	71 Km	252006 Km	153732 Km.
e.	Length of Aerial Bunched Cables	NA	NA	NA	NA
f.	Length of Underground Cables	NA	NA	NA	NA
3	Voltage level	Particulars	MU	Reference	Remarks (Source of data)
i	66kV and above (Inter-State)	Long-Term Conventional	25172.24	Includes input energy for franchisees	
		Medium Conventional (unscheduled interchange)	-441.94		value of unscheduled interchange energy is entered as the provision of the same has not provided in the performa
		Short Term Conventional	7471.95	10874.18-436.37	
		Banking	311.80		
		Long-Term Renewable energy	2691.16		
		Medium and Short-Term RE	0.00	Includes power from bilateral/ PX/ DEEP	

		Captive, open access input		Any power wheeled for any purchase other than sale to DISCOM. Does not include input for franchisee.	
		Sale of surplus power	-502.87		
		Quantum of inter-state transmission loss	1440.37	As confirmed by SLDC, RLDC etc	
		Power procured from inter-state sources	34702.34	Based on data from Form 5	
		Power at state transmission boundary	33261.97		
ii	66kV and above (Intra-State)	Long-Term Conventional	33411.30		Power procured from intra state sources at different voltage levels
		Medium Conventional	NA		
		Short Term Conventional	NA		
		Banking	NA		
		Long-Term Renewable energy	1975.30		NRSE power procured from intra state sources at 66KV and above
		Medium and Short-Term RE			
		Captive, open access input			
		Sale of surplus power			
		Quantum of intra-state transmission loss	2728.688		PSTCL Losses + PSPCL Sub transmission Losses
		Power procured from intra-state sources	35386.59		
iii		Input in DISCOM wires network	65920		
iv	33 kV	Renewable Energy Procurement	10.39		
		Small capacity conventional/ biomass/ hydro plants Procurement	0.00		
		Captive, open access input	0.00		
v	11 kV	Renewable Energy Procurement	230.07		NRSE power procured from intra state sources at 11KV
		Small capacity conventional/ biomass/ hydro plants Procurement	0.00		
		Sales Migration Input			
vi	LT	Renewable Energy Procurement	101.91		Roof Top Solar Energy
		Sales Migration Input	-101.91		
vii	Energy Embedded within DISCOM wires network	Energy Embedded within DISCOM wires network	240.46		
viii	Total Energy Available/ Input	Total Energy Available/ Input	66160.34		
4	Voltage level	Energy Sales Particulars	MU	Reference	
i	11KV/LT	DISCOM' consumers		Include sales to consumers in franchisee areas, unmetered consumers	
		Demand from open access, captive	0	Non DISCOM's sales	
		Embedded generation used		Demand from embedded generation at LT level	
		Sale at 11KV/LT level	0.00		Voltage wise energy requirement input not available instead available source wise.
		Quantum of 11KV/LT level losses	0.000		
		Energy input at 11 KV/ LT level			

ii	33 kV Level	DISCOM' consumers		Include sales to consumers in franchisee areas, unmetered consumers	
		Demand from open access, captive	0	Non DISCOM's sales	
		Embedded generation at 33 kV level used		Demand from embedded generation at 11kV level	
		Sales at 33 kV level	0.00		
		Quantum of Losses at 33 kV	0.000		
iii	66/33/11 / 0.44 KV	DISCOM' consumers	58709	Include sales to consumers in franchisee areas, unmetered consumers	
		Demand from open access, captive	0	Non DISCOM's sales	
		Embedded generation at 66 kV or below level		This is DISCOM and OA demand met via energy generated at same voltage level	
		Sales at 66 kV level	58709		
		Quantum of Losses at 66 kV	7452		
iv	> 66 kV	DISCOM' consumers		Include sales to consumers in franchisee areas, unmetered consumers	
		Demand from open access, captive	0	Non DISCOM's sales	
		Cross border sale of energy	0		
		Sale at other DISCOMs	0		
		Banking	0		
		Energy input at > 66kV Level	4169		
		Sales at 66kV and above (EHV)			
Total Energy Requirement			70329.40		
Total Energy Sales			58708.60		

Energy Accounting Summary

5	DISCOM	Input (in MU)	Sale (in MU)	Loss (in MU)	Loss %
i	LT				
ii	11KV				
iii	33 KV				
iv	66/33/11 / 0.44 KV	66160.34	58708.60	7451.74	11.26%
6	Open Access, Captive	Input (in MU)	Sale (in MU)	Loss (in MU)	
i	LT	0	0	0	
ii	11 Kv	0	0	0	
iii	33 kv	0	0	0	
iv	> 33 kv				

Loss Estimation for DISCOM	
T&D loss	11,621
D loss	7,452
T&D loss (%)	16.52%
D loss (%)	10.60%

NOTE: D losses 10.60 % are Calculated on the basis of availability of Power to PSPCL (At Generation Sources) i.e.70329 MU and D Losses in Division Wise Losses Sheet 11.26 % are calculated by Net input energy (At DISCOM Periphery after adjusting the transmission losses and energy traded) i.e. 66160 MU basis.

Details of Division Wise Losses (See note below**)																							
S.No	Name of circle	Circle code	Name of Division	Consumer profile										Energy parameters					Losses		Commercial Parameter		AT & C loss (%)
				Consumer category	No of connection metered (Nos)	No of connection Un-metered	Total Number of connections (Nos)	% of number of connections	Connected Load metered (MW)	Connected Load Un-metered (MW)	Total Connected Load (MW)	% of connected load	Input energy (MU)	Metered energy	Unmetered/assess ment energy	Total energy	% of energy consumption	T&D loss (MU)	T&D loss (%)	Billed Amount In Rs. Crore	Collected Amount In Rs. Crore	Collection Efficiency	
1	CITY AMRITSAR	8	DS CITY CENTER DIVN. ASR	Residential	45563	0	45563	71%	108.266	0	108.266	44%	109.75	109.747	40%						0.00%		
				Agricultural	263	0	263	0.4%	1.434	0	1.434	1%	5.23	5.231	2%						0.00%		
				Commercial/Industrial-LT	18277	0	18277	28%	123.075	0	123.075	50%	321.03	123.401	45%	48.87	15.22%				0.00%		
				Commercial/Industrial-HT	43	0	43	0%	13.989	0	13.989	6%	30.94	30.936	11%						0.00%		
				Others	150	0	150	0%	1.525	0	1.525	1%	2.85	2.848	1%			148.76	164.78	100.00%	15%		
Sub-total				64296	0	248.289	100%	248.289	0	321.03	272.160	0.000	272.160	100%	48.87	15.22%	148.76	164.78	100.00%	15%			
2	CITY AMRITSAR	8	DS CIVIL LINES TECH. DIVN.	Residential	31039	0	31039	48%	143.427	0	143.427	58%	135.95	135.953	50%						0.00%		
				Agricultural	7	0	7	0%	0.039	0	0.039	0%	0.00	0.000	0%						0.00%		
				Commercial/Industrial-LT	10205	0	10205	16%	115.948	0	115.948	47%	293.06	115.337	42%	31.36	10.70%				0.00%		
				Commercial/Industrial-HT	6	0	6	0%	6.681	0	6.681	3%	2.88	2.875	1%						0.00%		
				Others	68	0	68	1%	3.715	0	3.715	1%	7.54	7.535	3%			148.76	164.78	100.00%	100.00%		
Sub-total				41351	0	41351	100%	269.807	0	293.06	261.700	0.000	261.700	100%	31.36	10.70%	148.76	164.78	100.00%	111%			
3	CITY AMRITSAR	8	DS DIVN. HAKIMA GATE ASR	Residential	41585	0	41585	65%	89.865	0	89.865	36%	84.89	84.893	31%						0.00%		
				Agricultural	14	0	14	0%	0.088	0	0.088	0%	0.00	0.000	0%						0.00%		
				Commercial/Industrial-LT	22814	0	22814	35%	71.476	0	71.476	29%	181.12	59.62	58.670	22%	30.26	16.71%				0.00%	
				Commercial/Industrial-HT	7	0	7	0%	3.169	0	3.169	1%	3.71	3.708	1%						0.00%		
				Others	118	0	118	0%	1.067	0	1.067	0%	181.12	2.591	1%			148.76	164.78	100.00%	100.00%		
Sub-total				64518	0	64518	100%	165.764	0	181.12	154.863	0.000	154.863	100%	30.26	16.71%	148.76	164.78	100.00%	17%			
4	CITY AMRITSAR	8	DS INDL. AREA TECH. DIVN.	Residential	48994	0	48994	76%	104.876	0	104.876	42%	132.72	132.717	49%						0.00%		
				Agricultural	64	0	64	0%	0.273	0	0.273	0%	0.45	0.450	0%						0.00%		
				Commercial/Industrial-LT	13236	0	13236	21%	72.312	0	72.312	29%	249.54	64.03	64.025	24%	47.47	19.02%				0.00%	
				Commercial/Industrial-HT	7	0	7	0%	2.732	0	2.732	1%	3.96	3.956	1%						0.00%		
				Others	126	0	126	0%	0.91	0	0.91	0%	48.54	48.0	0%			148.76	164.78	100.00%	100.00%		
Sub-total				64627	0	64627	100%	181.103	0	249.54	202.070	0.000	202.070	100%	47.47	19.02%	148.76	164.78	100.00%	19%			
5	GURDASPUR	9	DS CITY DIVN. BATALA	Residential	72674	0	72674	54%	134.311	0	134.311	37%	364.72	154.329	37%						0.00%		
				Agricultural	306	13117	13423	21%	0.934	60.57	61.504	31%	154.329	154.329	31%						0.00%		
				Commercial/Industrial-LT	13813	0	13813	21%	58.651	0	58.651	24%	364.72	44.799	16%	65.71	18.02%				0.00%		
				Commercial/Industrial-HT	17	0	17	0%	8.476	0	8.476	3%	18.02%	14.525	8%						0.00%		
				Others	40	0	40	0%	0.646	0	0.646	0%	1.00	1.003	0%			185.18	219.25	100.00%	18%		
Sub-total				87859	13117	100976	100%	203.018	60.57	364.72	217.205	81.802	299.008	100%	65.71	18.02%	185.18	219.25	100.00%	18%			
6	GURDASPUR	9	DS CITY DIVN. PATHANKOT	Residential	136127	0	136127	55%	159.746	0	159.746	42%	495.89	205.76	42%						0.00%		
				Agricultural	112	4648	4760	7%	1.639	17.234	18.873	8%	3.54	39.69	43.636	16%						0.00%	
				Commercial/Industrial-LT	25709	0	25709	40%	80.575	0	80.575	32%	495.89	70.86	70.860	26%	24.92	5.02%				0.00%	
				Commercial/Industrial-HT	146	0	146	0%	71.946	0	71.946	29%	121.15	121.247	41%						0.00%		
				Others	64	0	64	0%	16.942	0	16.942	7%	41.057	41.057	15%			294.72	327.50	100.00%	5%		
Sub-total				142158	4648	146806	100%	330.848	17.234	495.89	431.282	39.693	470.975	100%	24.92	5.02%	294.72	327.50	100.00%	5%			
7	GURDASPUR	9	DS DIVN. QADIAN	Residential	56796	0	56796	73%	79.753	0	79.753	32%	378.12	131.12	32%						0.00%		
				Agricultural	165	15641	15806	25%	0.243	59.297	59.540	24%	378.12	61.3	136.20	50%						0.00%	
				Commercial/Industrial-LT	7045	0	7045	11%	16.645	0	16.645	7%	378.12	22.97	22.969	8%	72.41	19.15%				0.00%	
				Commercial/Industrial-HT	7	0	7	0%	3.004	0	3.004	1%	9.03	9.030	3%						0.00%		
				Others	27	0	27	0%	0.434	0	0.434	0%	0.258	0.258	0%			170.92	216.03	100.00%	100.00%		
Sub-total				64041	15641	79682	100%	99.088	59.297	378.12	169.507	136.201	305.708	100%	72.41	19.15%	170.92	216.03	100.00%	19%			
8	GURDASPUR	9	DS DIVN. DHARWAL	Residential	72008	0	72008	114%	118.37	0	118.37	48%	378.12	106.59	48%						0.00%		
				Agricultural	117	20373	20490	32%	1.07	96.171	97.241	39%	378.12	14.32	81.19	82.515	30%					0.00%	
				Commercial/Industrial-LT	8718	0	8718	14%	25.328	0	25.328	10%	378.12	16.40	16.398	6%	53.10	20.26%				0.00%	
				Commercial/Industrial-HT	16	0	16	0%	5.33	0	5.33	2%	2.58	2.583	1%						0.00%		
				Others	6	0	6	0%	0.102	0	0.102	0%	0.56	0.568	0%			121.30	153.92	100.00%	100.00%		
Sub-total				81865	20373	102238	100%	150.2	96.171	378.12	127.857	81.192	209.049	100%	53.10	20.26%	121.30	153.92	100.00%	20%			
9	GURDASPUR	9	DS DIVN. GURDASPUR	Residential	108983	0	108983	170%	166.226	0	166.226	67%	405.15	201.134	74%						0.00%		
				Agricultural	18674	18607	37281	58%	63.207	63.207	63.207	26%	405.15	64.86	72.12	72.976	27%					0.00%	
				Commercial/Industrial-LT	16411	0	16411	26%	49.533	0	49.533	20%	405.15	44.71	44.708	16%	61.96	15.29%				0.00%	
				Commercial/Industrial-HT	19	0	19	0%	7.036	0	7.036	3%	8.66	8.658	3%						0.00%		
				Others	36	0	36	0%	5.625	0	5.625	2%	13.71	13.712	6%			205.38	246.50	100.00%	100.00%		
Sub-total				125216	18607	143823	100%	228.647	63.107	405.15	271.064	72.124	343.188	100%	61.96	15.29%	205.38	246.50	100.00%	15%			
10	GURDASPUR	9	DS S/U DIVN. BATALA	Residential	95526	0	95526	149%	127.549	0	127.549	51%	481.77	172.68	51%						0.00%		
				Agricultural	243	25977	26220	40%	0.791	109.523	110.314	44%	481.77	6.35	124.37	130.725	48%					0.00%	
				Commercial/Industrial-LT	11103	0	11103	17%	43.905	0	43.905	18%	481.77	38.49	38.485	13%	128.05	26.58%				0.00%	
				Commercial/Industrial-HT	31	0	31	0%	9.53	0	9.53	4%	481.77	9.22	9.215	3%						0.00%	
				Others	50	0	50	0%	2.149	0	2.149	1%	481.77	4.62	4.615	2%			200.71	244.03	100.00%	100.00%	
Sub-total				106959	25977	132936	100%	183.524	109.523	481.77	225.352	124.371	353.723	100%	128.05	26.58%	200.71	244.03	100.00%	27%			
11	GURDASPUR	9	DS S/U DIVN. PATHANKOT	Residential	92336	0	92336	144%	134.603	0	134.603	54%	336.29	159.57	54%						0.00%		
				Agricultural	230	5195																	

17	TARN TARAN	12	DS CITY DIVN. TARN TARAN	Residential	69967		69967	100%	100	911	41%	141.21		141.210	52%			0.00%		
				Agricultural	28	17923	17953	100%	123.88	123.728	99%	30.27	12%	33.33	161.55	133.334	17%	162.66	30.97%	0.00%
				Commercial/Industrial-LT	9123		9123	14%	30.27			11.129	4%	24.37		24.368	9%			0.00%
				Commercial/Industrial-HT	18		18	0%	11.129			0.855	0%	1.59		1.59	2%			0.00%
				Others	29		29	0%	0.855			0.000	0%	0.000		0.000	0%			0.00%
Sub-total			79156	17923	97079	100%	143.317	123.728	267.045	100%	201.408	161.552	362.961	100%	162.66	30.97%	210.70	364.82	100.00%	
18	TARN TARAN	12	DS DIVN. BAKHWARD	Residential	44438		44438	69%	65.239	26%	61.28		61.281	27%				0.00%		
				Agricultural	0	19779	19779	81%	17.647	152.906	152.906	62%	15.40	181.91	181.509	67%	250.91	48.54%		0.00%
				Commercial/Industrial-LT	5230		5230	3%	17.647			17.647	7%	15.40	15.436	6%			0.00%	
				Commercial/Industrial-HT	4		4	0%	1.493			2.432	1%	2.432		2.432	1%			0.00%
				Others	12		12	0%	1.912			0.544	2%	0.544		0.544	2%			0.00%
Sub-total			49604	19779	69473	100%	86.291	152.906	239.196	100%	84.473	181.509	265.982	100%	250.91	48.54%	174.83	214.50	100.00%	
19	TARN TARAN	12	DS DIVN. PATTI	Residential	61656		61656	96%	94.427	88%	101.96		101.961	37%				0.00%		
				Agricultural	7	20881	20959	33%	0.615	174.264	174.879	70%	8.36	229.61	237.965	87%	273.18	42.54%		0.00%
				Commercial/Industrial-LT	6889		6889	11%	23.654			23.654	9%	23.654	23.658	9%			0.00%	
				Commercial/Industrial-HT	4		4	0%	3.218			3.218	1%	3.218		3.218	1%			0.00%
				Others	75		75	0%	0.451			0.451	0%	0.451		0.451	0%			0.00%
Sub-total			68632	20881	89513	100%	122.365	174.264	296.626	100%	123.463	229.609	353.058	100%	273.18	42.54%	211.97	292.85	100.00%	
20	TARN TARAN	12	DS DIVN. RAYTA AT BEA	Residential	84203		84203	131%	144.042	58%	179.87		179.870	66%				0.00%		
				Agricultural	48	20337	20385	32%	0.46	130.729	131.189	53%	0.75	150.28	151.020	55%	87.97	10.01%		0.00%
				Commercial/Industrial-LT	9030		9030	14%	33.428			33.428	13%	30.95	30.946	11%			0.00%	
				Commercial/Industrial-HT	9		9	0%	2.835			2.835	1%	4.12	4.124	2%			0.00%	
				Others	15		15	0%	6.141			6.141	2%	8.84		8.84	3%			0.00%
Sub-total			92995	20337	113332	100%	186.916	130.729	317.645	100%	182.77	150.275	333.801	100%	87.97	10.01%	219.14	268.02	100.00%	
21	TARN TARAN	12	DS S/U DIVN. TARN TARAN	Residential	52757		52757	87%	84.949	30%	121.627		121.627	45%				0.00%		
				Agricultural	0	15530	15530	24%	0.00	115.831	47%	0.00	131.17	131.170	48%			0.00%		
				Commercial/Industrial-LT	6084		6084	9%	29.743			29.743	12%	27.589	27.589	10%	118.45	27.62%		0.00%
				Commercial/Industrial-HT	35		35	0%	49.855			49.855	20%	29.786	29.786	11%			0.00%	
				Others	12		12	0%	0.412			0.412	0%	0.304		0.304	0%	182.19	227.69	100.00%
Sub-total			61668	15530	77198	100%	164.959	115.831	280.79	100%	179.332	131.170	310.492	100%	118.45	27.62%	182.19	227.69	100.00%	
22	CITY EAST LUHIANA	13	DS CITY CEN. (SPL) DIVN. LDH	Residential	21668		21668	12%	70.191	21%	51.78		51.778	21%				0.00%		
				Agricultural	1	0	1	0%	0.005	0	0.005	0%	0.00	0.00	0.00	0%	4.75	2.29%		0.00%
				Commercial/Industrial-LT	27755		27755	43%	159.384			159.384	64%	137.37	137.367	50%			0.00%	
				Commercial/Industrial-HT	4		4	0%	2.1			2.1	1%	3.88	3.888	1%			0.00%	
				Others	132		132	0%	2.371			2.371	1%	4.051		4.051	1%	133.43	140.50	100.00%
Sub-total			48461	0	48461	100%	234.607	0	234.607	100%	202.656	0.000	202.656	100%	4.75	2.29%	133.43	140.50	100.00%	
23	CITY EAST LUHIANA	13	DS CMC (SPL) DIVN. LDH	Residential	36152		36152	56%	96.424	30%	126.53		126.527	39%				0.00%		
				Agricultural	0	0	0	0%	0.00	0	0.00	0%	0.00	0.00	0.00	0%	7.64	1.83%		0.00%
				Commercial/Industrial-LT	17240		17240	27%	176.72			176.72	71%	194.42	194.423	71%			0.00%	
				Commercial/Industrial-HT	144		144	0%	99.941			99.941	24%	94.205	94.205	34%			0.00%	
				Others	139		139	0%	8.675			8.675	4%	14.562	14.562	5%	286.52	299.71	100.00%	
Sub-total			53665	0	53665	100%	340.96	0	340.917	100%	409.117	0.000	409.117	100%	7.64	1.83%	286.52	299.71	100.00%	
24	CITY EAST LUHIANA	13	DS F. POINT (SPL) DIVN. LDH	Residential	8789		8789	13%	197.811	87%	227.92		227.917	84%				0.00%		
				Agricultural	373	355	728	11%	3.374	2.492	3.866	2%	2.007	3%	2.007	3%	1.31	0.06%		0.00%
				Commercial/Industrial-LT	19383		19383	30%	270.884			270.884	108%	298.588	298.588	110%			0.00%	
				Commercial/Industrial-HT	905		905	1%	671.746			671.746	271%	165.83	165.832	608%			0.00%	
				Others	264		264	0%	2.493			2.493	2%	4.300	4.300	2%	1560.98	1520.18	97.39%	
Sub-total			109564	355	109919	100%	1144.308	2.492	2187.541	100%	2187.294	1.753	2187.041	100%	1.31	0.06%	1560.98	1520.18	97.39%	
25	CITY EAST LUHIANA	13	SUNDER NAGAR LDH	Residential	77176		77176	120%	135.297	54%	176.71		176.708	66%				0.00%		
				Agricultural	18	2909	2928	5%	0.047	18.675	18.722	8%	0.04	16.25	16.294	6%	40.27	5.32%		0.00%
				Commercial/Industrial-LT	24185		24185	38%	281.308			281.308	113%	342.034	342.034	126%			0.00%	
				Commercial/Industrial-HT	222		222	0%	96.117			96.117	39%	178.19	178.187	65%			0.00%	
				Others	162		162	0%	0.848			0.848	3%	1.85	1.85	1%	469.97	501.69	100.00%	
Sub-total			101764	2909	104673	100%	513.617	18.675	512.292	100%	700.819	16.255	717.074	100%	40.27	5.32%	469.97	501.69	100.00%	
26	CITY WEST LUHIANA	14	DS AGAR, NGR. (SPL) DIVN.	Residential	94667		94667	147%	414.698	167%	359.35		359.350	132%				0.00%		
				Agricultural	376	1463	1839	3%	0.793	10.039	10.838	4%	0.76	10.42	11.179	4%	42.57	6.99%		0.00%
				Commercial/Industrial-LT	17376		17376	27%	148.946			148.946	60%	158.34	158.343	57%			0.00%	
				Commercial/Industrial-HT	22		22	0%	14.673			14.673	6%	32.639	32.639	12%			0.00%	
				Others	207		207	0%	8.493			8.493	3%	8.784	8.784	3%	419.34	450.67	100.00%	
Sub-total			122448	1463	123911	100%	587.603	10.039	597.638	100%	555.874	10.424	566.295	100%	42.57	6.99%	419.34	450.67	100.00%	
27	CITY WEST LUHIANA	14	WEST LUHIANA	Residential	52943		52943	82%	209.917	80%	204.29		204.290	75%				0.00%		
				Agricultural	0	677	677	1%	0.236	3.216	3.452	1%	3.161	1%	3.161	1%	25.58	4.04%		0.00%
				Commercial/Industrial-LT	18252		18252	28%	233.07			233.07	90%	235.20	235.199	86%			0.00%	
				Commercial/Industrial-HT	250		250	0%	81.234			81.234	33%	133.886	133.886	50%			0.00%	
				Others	181		181	0%	8.027			8.027	3%	28.271	28.271	10%	422.05	424.92	100.00%	
Sub-total			71689	677	72366	100%	532.484	3.216	535.7	100%	603.462	3.125	606.807	100%	25.58	4.04%	422.05	424.92	100.00%	
28	CITY WEST LUHIANA	14	DS ESTATE (SPL) DIVN. LDH	Residential	57227		57227	89%	102.788	41%	127.92		127.919	47%				0.00%		
				Agricultural	197	1986	2183	3%	1.199	8.347	10.546	4%	0.69	12.51	13.204	5%	91.75	5.06%		0.00%
				Commercial/Industrial-LT	23235		23235	36%	361.524			361.524	146%	320.36	320.357	114%			0.00%	
				Commercial																

35	KHANA	15	DS DIVN. SIRHANO	Residential	7422		7422	116%	178.828	178.828	52%	170.65		170.654	63%			0.00%		
				Agricultural	0	15931	0	15931	0	140.856	140.856	52%	0	172.52	172.52	64%			0.00%	
				Commercial/Industrial-LT	12843		12843	20%	65.956	65.956	27%			65.557	24%			0.00%		
				Commercial/Industrial-HT	79		79	0%	86.466	86.466	100%	35%		272.879	100%			0.00%		
				Others	21		21	0%	0.565	0.565	0%			2.041	2%			422.88	486.60	100.00%
Sub-total				87385	15931	103296	100%	281.815	140.456	100%	514.058	172.525	686.583	100%	58.13	7.81%	422.88	486.60	100.00%	
36	SUB URBAN LUDHIANA	17	DS DIVN. ADDA DAKAR	Residential	5471		5471	80%	109.701	109.701	44%	131.42		131.418	48%			0.00%		
				Agricultural	0	13918	0	13918	11%	139.18	139.18	46%			131.671	48%			0.00%	
				Commercial/Industrial-LT	9280		9280	21%	47.925	47.925	100%	35%		42.026	35%			27.60	6.29%	0.00%
				Commercial/Industrial-HT	127		127	0%	50.717	50.717	20%			91.556	34%			0.00%		
				Others	21		21	0%	4.966	4.966	0%			14.448	5%			256.73	294.76	100.00%
Sub-total				65897	13518	79415	100%	213.309	108.181	100%	438.81	275.759	131.418	411.217	100%	27.60	6.29%	256.73	294.76	100.00%
37	SUB URBAN LUDHIANA	17	DS DIVN. AHMEDGARH	Residential	4242		4242	66%	80.204	80.204	32%	91.20		91.430	34%			0.00%		
				Agricultural	0	10244	0	10244	16%	0	87.707	87.707	35%			94.811	35%			0.00%
				Commercial/Industrial-LT	7432		7432	12%	36.167	36.167	100%	10%		30.300	11%			29.32	8.94%	0.00%
				Commercial/Industrial-HT	96		96	0%	39.62	39.62	16%			81.196	30%			0.00%		
				Others	7		7	0%	0.161	0.161	0%			0.656	0%			188.00	218.84	100.00%
Sub-total				49987	10244	60231	100%	136.152	87.707	100%	327.91	203.859	94.696	298.559	100%	39.32	8.94%	188.00	218.84	100.00%
38	SUB URBAN LUDHIANA	17	DS DIVN. JAGMOH	Residential	58713		58713	70%	111.179	111.179	30%	139.65		139.653	38%			0.00%		
				Agricultural	48	14567	14615	17%	0.267	113.916	114.183	36%			134.303	36%			0.00%	
				Commercial/Industrial-LT	10080		10080	12%	47.58	47.58	100%	15%		42.57	42.568	12%			0.00%	
				Commercial/Industrial-HT	151		151	0%	39.473	39.473	15%			50.071	14%			11.57	12.26%	0.00%
				Others	12		12	0%	2.454	2.454	1%			2.557	1%			229.58	275.30	100.00%
Sub-total				69608	14567	84175	100%	209.319	113.916	100%	420.72	235.214	129.936	365.150	100%	11.57	12.26%	229.58	275.30	100.00%
39	SUB URBAN LUDHIANA	17	DS DIVN. RAKHOT	Residential	8905		8905	100%	93.905	93.905	20%	129.43		129.426	33%			0.00%		
				Agricultural	18	17104	17122	21%	0.128	187.722	187.858	56%			237.662	57%			0.00%	
				Commercial/Industrial-LT	789		789	9%	30.548	30.548	7%			28.655	7%			50.95	10.92%	0.00%
				Commercial/Industrial-HT	89		89	0%	23.073	23.073	7%			19.493	5%			0.00%		
				Others	3		3	0%	0.118	0.118	0%			0.451	0%			241.33	299.45	100.00%
Sub-total				65588	17104	82692	100%	134.697	187.858	100%	466.64	176.317	237.370	413.687	100%	50.95	10.92%	241.33	299.45	100.00%
40	SUB URBAN LUDHIANA	17	DS S/U DIVN. LALTON KALAN	Residential	62477		62477	74%	138.087	138.087	35%	165.44		165.435	28%			0.00%		
				Agricultural	27	12906	12933	15%	0.156	106.376	106.532	30%			131.424	23%			0.00%	
				Commercial/Industrial-LT	9191		9191	11%	66.934	66.934	19%			54.000	19%			31.53	6.72%	0.00%
				Commercial/Industrial-HT	60		60	0%	44.316	44.316	13%			86.296	30%			0.00%		
				Others	13		13	0%	0.195	0.195	0%			0.705	0%			274.78	313.89	100.00%
Sub-total				73777	12906	86683	100%	249.588	106.376	100%	469.42	306.472	131.419	437.891	100%	31.53	6.72%	274.78	313.89	100.00%
41	HOSHARPUR	23	DS CITY DIVN. HSP	Residential	91693		91693	173.07%	173.07	173.07	40%	164.34		164.34	28%			0.00%		
				Agricultural	307	5327	5634	5%	1.825	45.404	47.223	14%			62.925	13%			0.00%	
				Commercial/Industrial-LT	24419		24419	20%	80.675	80.675	23%			84.537	18%			50.15	9.70%	0.00%
				Commercial/Industrial-HT	23		23	0%	44.139	44.139	15%			190.789	34%			0.00%		
				Others	95		95	0%	2.479	2.479	1%			4.100	1%			302.22	343.72	100.00%
Sub-total				116447	5327	121774	100%	302.145	45.404	100%	516.85	403.817	62.879	466.696	100%	50.15	9.70%	302.22	343.72	100.00%
42	HOSHARPUR	23	DS DIVN. BHOGPUR	Residential	7472		7472	73%	128.775	128.775	45%	122.44		122.444	39%			0.00%		
				Agricultural	176	15263	15439	13%	0.631	110.069	110.688	30%			134.47	39%			0.00%	
				Commercial/Industrial-LT	11833		11833	12%	35.769	35.769	11%			36.234	11%			33.83	8.98%	0.00%
				Commercial/Industrial-HT	17		17	0%	13.173	13.173	5%			38.910	11%			202.46	243.36	100.00%
				Others	39		39	0%	0.386	0.386	0%			0.776	0%			0.00%		
Sub-total				86437	15263	101700	100%	178.734	110.069	100%	376.70	290.396	134.473	342.869	100%	33.83	8.98%	202.46	243.36	100.00%
43	HOSHARPUR	23	DS DIVN. DASUVA	Residential	72212		72212	77%	139.47	139.47	60%	143.90		143.903	3638%			0.00%		
				Agricultural	86	11185	11271	13%	0.114	54.962	55.076	24%			79.45	85.141	2030%		0.00%	
				Commercial/Industrial-LT	12208		12208	33%	33.788	33.788	15%			38.958	985%			31.72	10.52%	0.00%
				Commercial/Industrial-HT	8		8	0%	2.498	2.498	1%			3.86	98%			0.00%		
				Others	43		43	0%	1.599	1.599	4%			2.94	7%			148.33	180.33	100.00%
Sub-total				89907	11185	101092	100%	177.469	54.962	100%	301.52	190.347	79.454	269.802	100%	31.72	10.52%	148.33	180.33	100.00%
44	HOSHARPUR	23	DS DIVN. MAHIPUR	Residential	72758		72758	79%	101.06	101.06	43%	112.10		112.105	41%			0.00%		
				Agricultural	67	8994	9061	10%	0.345	88.366	88.711	38%			114.062	41%			0.00%	
				Commercial/Industrial-LT	10782		10782	12%	29.471	29.471	13%			38.222	13%			114.69	29.59%	0.00%
				Commercial/Industrial-HT	15		15	0%	16.139	16.139	7%			11.353	4%			0.00%		
				Others	4		4	0%	0.11	0.11	0%			0.194	0%			157.02	196.91	100.00%
Sub-total				83602	8994	92596	100%	147.125	88.366	100%	387.63	160.487	112.446	273.853	100%	114.69	29.59%	157.02	196.91	100.00%
45	HOSHARPUR	23	DS DIVN. MUKERIAN	Residential	97734		97734	78%	158.398	158.398	64%	163.98		163.98	58%			0.00%		
				Agricultural	0	8483	8528	7%	0.135	31.713	31.848	13%			63.837	23%			0.00%	
				Commercial/Industrial-LT	18339		18339	15%	45.076	45.076	28%			38.289	28%			5.01	1.76%	0.00%
				Commercial/Industrial-HT	46		46	0%	13.041	13.041	5%			12.784	5%			0.00%		
				Others	6		6	0%	0.73	0.73	0%			1.892	1%			160.96	193.69	100.00%
Sub-total				116373	8483	124856	100%	212.36	31.713	100%	284.80	216.114	63.770	279.884	100%	5.01	1.76%	160.96	193.69	100.00%
46	HOSHARPUR	23	DS S/U DIVN. HSP	Residential	71967		71967	78%	89.282	89.282	23%	117.04		117.041	17%			0.00%		
				Agricultural	19	10536	10555	11%	0.221	94.331	94.552	24%			118.555	17%			0.00%	
				Commercial/Industrial-LT	10383		10383	11%	47.716	47.716	12%			47.556	7%			33.22	0.00%	
				Commercial/Industrial-HT	77		77	0%	154.778	154.778	40%			412.346	99%			0.00%		
				Others	3		3	0%	0.027	0.027	0%			0.085	0%			435.26	489.37	100.00%
Sub-total				82447	10536</															

53	KAPURTHALA	25	DS CIVT DIVN. NAODDA	Residential	74099		74099	69%	122 311		122 311	35%		129 46		129 456	33%			0.00%			
				Agricultural	0	21412	0	21412	0%	0		173 356		173 356	50%		0		0	0	0	0.00%	
				Commercial/Industrial-LT	11127		35 419		35 419	10%					10%		35 37		35 374	9%		0.00%	
				Commercial/Industrial-HT	69		17 276		17 276	5%					5%		28 11		28 112	7%		0.00%	
				Others	23		0		0	0%					0%		0 70		0 70	0%		0.00%	
Sub-total				85227	21412	100799	100%	175 534	173 356	348 89	100%	475.73	193 809	201 247	395 056	100%	80.67	16.96%	233 41	290 35	100.00%		
54	KAPURTHALA	25	DS DIVN. KARTARPUR	Residential	18013		18013	71%	119 153		119 153	43%		1 56		125 859	43%			0.00%			
				Agricultural	9067	14777	23844	18%	48 076	87 036	31%				1 56	91 90	94 565	24%			0.00%		
				Commercial/Industrial-LT	9067		33 676		33 676	13%					13%		36 80	36 802	13%		23.83	7.52%	
				Commercial/Industrial-HT	53		36 208		36 208	1%					1%		30 86	30 866	1%			0.00%	
				Others	23		2 814		2 814	1%					1%		1 99	1 999	1%			176.54	207.62
Sub-total				67202	14777	81979	100%	192 631	87 036	279 667	100%	316.82	201 087	91 904	292 991	100%	23.83	7.52%	176.54	207.62	100.00%		
55	KAPURTHALA	25	DS S/U DIVN. KAPURTHALA	Residential	73732		73732	70%	150 154		150 154	47%		178 01		178 029	48%				0.00%		
				Agricultural	202	18746	18946	18%	0 51	103 9	31%				31%		103 839	28%				0.00%	
				Commercial/Industrial-LT	12465		46 3018		46 3018	14%					14%		44 57	44 573	12%			39.80	9.65%
				Commercial/Industrial-HT	22		8 95		8 95	3%					3%		31 892	31 892	9%				0.00%
				Others	40		10 433		10 433	3%					3%		14 31	14 306	4%			221.26	254.18
Sub-total				84439	18746	103185	100%	216 4059	103 9	320 31059	100%	412.44	264 883	103 754	377 638	100%	39.80	9.65%	221.26	254.18	100.00%		
56	KAPURTHALA	25	DS S/U DIVN. NAODDA	Residential	64852		64852	72%	154 888		154 888	42%		162 78		162 777	36%					0.00%	
				Agricultural	49	17266	17315	15%	0 157	150 688	41%				41%		1 45	218 81	220 258	48%			0.00%
				Commercial/Industrial-LT	14717		48 164		48 164	13%					13%		43 17	43 170	9%		58.77	11.36%	
				Commercial/Industrial-HT	33		13 655		13 655	4%					4%		31 28	31 280	7%				0.00%
				Others	22		0 428		0 428	0%					0%		0 99	0 990	0%			267 13	324 90
Sub-total				69643	17266	86909	100%	217 252	150 688	367 946	100%	517.24	292 667	218 806	486 475	100%	58.77	11.36%	267 13	324 90	100.00%		
57	NAWANSHAHR	26	DS DIVN. BANGA	Residential	69543		69543	77%	121 267		121 267	51%		130 22		130 225	42%					0.00%	
				Agricultural	14	11427	11441	13%	0 655	82 132	34%				34%		0 04	118 67	118 713	45%			0.00%
				Commercial/Industrial-LT	9129		29 379		29 379	12%					12%		26 10	26 100	10%			39.08	12.93%
				Commercial/Industrial-HT	16		5 002		5 002	2%					2%		5 85	5 846	2%				0.00%
				Others	9		1 014		1 014	0%					0%		1 35	1 350	1%			153 84	190 20
Sub-total				78711	11427	90138	100%	134 001	82 132	216 133	100%	302.30	144 559	119 667	264 226	100%	39.08	12.93%	153 84	190 20	100.00%		
58	NAWANSHAHR	26	DS DIVN. GARIKSHANKAR	Residential	100155		100155	81%	134 401		134 401	41%		135 13		135 125	41%					0.00%	
				Agricultural	31	10512	10543	9%	0 106	88 358	33%				33%		0 09	168 15	168 234	44%			0.00%
				Commercial/Industrial-LT	12501		42 829		42 829	16%					16%		48 15	48 146	13%		101.58	21.17%	
				Commercial/Industrial-HT	12		5 395		5 395	2%					2%		6 11	6 113	1%				0.00%
				Others	7		0 263		0 263	0%					0%		0 50	0 502	0%			214 43	265 05
Sub-total				112716	10512	123228	100%	182 994	88 358	271 352	100%	479.90	210 174	168 146	370 320	100%	101.58	21.17%	214 43	265 05	100.00%		
59	NAWANSHAHR	26	DS DIVN. GORAYA	Residential	75647		75647	73%	133 311		133 311	39%		124 40		124 405	39%					0.00%	
				Agricultural	204	12758	12962	13%	1 089	95 144	28%				28%		1 80	143 01	144 810	33%			0.00%
				Commercial/Industrial-LT	12771		53 086		53 086	16%					16%		56 70	56 705	13%		48 51	10 06%	
				Commercial/Industrial-HT	61		50 091		50 091	16%					16%		102 13	102 126	24%				0.00%
				Others	15		0 506		0 506	0%					0%		1 77	1 762	0%			266 09	310 12
Sub-total				88594	12758	101352	100%	243 083	95 144	338 227	100%	482.32	290 806	143 007	433 812	100%	48 51	10 06%	266 09	310 12	100.00%		
60	NAWANSHAHR	26	DS DIVN. NAWANSHAHR	Residential	73130		73130	74%	133 92		133 92	50%		130 87		130 874	41%					0.00%	
				Agricultural	139	11730	11869	12%	0 718	66 402	21%				21%		26 18	84 37	110 550	30%			0.00%
				Commercial/Industrial-LT	13568		52 561		52 561	20%					20%		47 02	47 025	15%		4 93	1 53%	
				Commercial/Industrial-HT	37		13 884		13 884	5%					5%		26 90	26 902	8%				0.00%
				Others	14		1 281		1 281	0%					0%		1 68	1 681	1%			190 87	228 89
Sub-total				86879	11730	98609	100%	202 346	66 402	268 748	100%	321.96	232 665	84 367	317 032	100%	4 93	1 53%	190 87	228 89	100.00%		
61	BARNALA	78	DS CIVT DIVN. BARNALA	Residential	76340		76340	68%	142 513		142 513	26%		171 58		171 582	26%					0.00%	
				Agricultural	23	23184	23207	21%	0 152	273 674	51%				51%		0 17	350 77	351 193	53%			0.00%
				Commercial/Industrial-LT	13218		68 785		68 785	13%					13%		65 910	65 910	10%		149 67	18 52%	
				Commercial/Industrial-HT	81		54 098		54 098	10%					10%		61 14	61 135	9%				0.00%
				Others	19		2 274		2 274	0%					0%		6 64	6 638	1%			398 77	488 22
Sub-total				89674	23184	112858	100%	267 822	273 674	541 496	100%	808.27	507 812	300 772	608 604	100%	149 67	18 52%	398 77	488 22	100.00%		
62	BARNALA	78	DS DIVN. DHURI	Residential	67094		67094	68%	111 279		111 279	24%		148 40		148 400	26%					0.00%	
				Agricultural	21	19912	19933	20%	0 162	241 956	32%				32%		0 56	300 66	301 220	32%			0.00%
				Commercial/Industrial-LT	11366		62 7472		62 7472	13%					13%		55 81	55 806	10%		96 46	14 38%	
				Commercial/Industrial-HT	121		53 252		53 252	11%					11%		67 91	67 909	12%				0.00%
				Others	11		0 536		0 536	0%					0%		1 16	1 160	0%			348 31	419 52
Sub-total				78613	19512	98125	100%	227 9372	241 956	469 8972	100%	670.99	372 887	300 664	574 531	100%	96 46	14 38%	348 31	419 52	100.00%		
63	BARNALA	78	DS DIVN. MALEKOTLA	Residential	89626		89626	72%	145 02187		145 02187	26%		196 48		196 484	24%					0.00%	
				Agricultural	1817	18379	19196	15%	0 21027	208 26325	38%				38%		0 30	248 86	249 156	31%			0.00%
				Commercial/Industrial-LT	16747		87 820763		87 820763	18%					18%		79 01	79 009	10%		57 31	6 64%	
				Commercial/Industrial-HT	109		103 640501		103 640501	19%					19%		271 60	271 598	34%				

71	PATALA	31	DS DIVN. SAMANA	Residential	52994		52994	69%	74.46	74.46	18%	116.72	116.717	18%			0.00%					
				Agricultural	48	15068	15116	20%	0.238	185.478	185.478	48%	0.56	223.54	223.097	24%			0.00%			
				Commercial/Industrial-LT	8051		8051	11%	49.231			13%	49.231		45.567	8%	110.42	14.00%	0.00%			
				Commercial/Industrial-HF	114		114	0%	73.571			19%	73.571		265.226	40%			0.00%			
				Others	8		8	0%	0.159			0%	0.159		0.553	0%			0.00%			
Sub-total				61225	15068	76293	100%	197.759	185.478	383.237	100%	766.58	432.624	223.536	656.160	100%	110.42	14.00%	408.83	456.55	100.00%	14%
72	PATALA	31	DS EAST DIVN PATALA	Residential	70520		70520	73%	59.313	59.313	24%	149.78	149.784	27%			0.00%					
				Agricultural	8286	18127	18195	19%	16.054	229.82	229.824	36%	1.74	253.76	255.504	46%			0.00%			
				Commercial/Industrial-LT	8286		8286	9%	44.429			13%	44.429		43.773	8%	50.51	14.09%	0.00%			
				Commercial/Industrial-HF	47		47	0%	32.542			8%	32.542		92.868	17%			0.00%			
				Others	19		19	0%	5.344			1%	5.344		14.879	3%			0.00%			
Sub-total				79340	18127	97467	100%	182.282	229.82	412.102	100%	645.22	300.553	253.761	554.314	100%	50.51	14.09%	134.81	406.63	100.00%	14%
73	PATALA	31	DS S/U DIVN PATALA	Residential	82424		82424	76%	155.152	155.152	86%	182.689	182.689	34%			0.00%					
				Agricultural	92	15880	15972	15%	0.489	166.386	166.386	39%	1.05	200.89	201.937	38%			0.00%			
				Commercial/Industrial-LT	9674		9674	9%	57.488			10%	57.488		50.722	10%	81.92	11.40%	0.00%			
				Commercial/Industrial-HF	35		35	0%	46.528			11%	46.528		91.801	17%			0.00%			
				Others	69		69	0%	1.716			0%	1.716		2.492	0%			0.00%			
Sub-total				92294	15880	108174	100%	261.873	166.386	428.259	100%	611.57	323.760	200.886	423.648	100%	81.92	11.40%	140.35	387.84	100.00%	13%
74	PATALA	31	DS WEST DIVN PATALA	Residential	62205		62205	72%	188.909	188.909	55%	158.63	158.677	60%			0.00%					
				Agricultural	153	0	153	0%	1.052	0	0	0%	1.18	0.00	1.175	0%			0.00%			
				Commercial/Industrial-LT	16906		16906	20%	111.81	211.81	211.81	30%	103.33	303.327	31%	34.61	9.50%	0.00%				
				Commercial/Industrial-HF	39		39	0%	41.488			12%	23.95		23.949	7%			0.00%			
				Others	117		117	0%	1.06			0%	2.52		1%	222.29	250.02	100.00%	0.00%			
Sub-total				89400	0	89400	100%	344.519	0	344.519	100%	364.52	320.648	0.000	420.648	100%	34.61	9.50%	222.29	250.02	100.00%	10%
75	ROPAR	32	DS DIVN. KHARAR	Residential	147485		147485	83%	398.946	398.946	50%	376.802	376.802	45%			0.00%					
				Agricultural	292	12249	12541	7%	2.156	116.301	116.301	16%	0.48	143.92	144.405	17%			0.00%			
				Commercial/Industrial-LT	18281		18281	10%	124.587			17%	149.18		148.179	17%	74.52	7.89%	0.00%			
				Commercial/Industrial-HF	112		112	0%	77.05			13%	159.76		139.759	22%			0.00%			
				Others	40		40	0%	2.93			0%	4.57		4.569	1%			0.00%			
Sub-total				166210	12249	178459	100%	605.669	116.301	721.97	100%	944.23	725.785	143.925	869.710	100%	74.52	7.89%	519.25	613.34	100.00%	8%
76	ROPAR	32	DS DIVN. ANANDPUR SAHIB	Residential	99244		99244	94%	149.94552	149.94552	15%	156.413	156.413	21%			0.00%					
				Agricultural	0	5825	5825	5%	26.759	26.759	12%	0.00	79.47	78.467	12%			0.00%				
				Commercial/Industrial-LT	14908		14908	12%	54.879			14%	55.68		55.676	8%	-9.94	-1.50%	0.00%			
				Commercial/Industrial-HF	120		120	0%	159.048			40%	139.07		139.069	56%			0.00%			
				Others	120		120	0%	1.563			0%	2.90		2.90	0%			0.00%			
Sub-total				110456	5825	120281	100%	365.43552	26.759	392.19452	100%	663.49	593.959	79.467	673.425	100%	-9.94	-1.50%	442.15	482.37	100.00%	-1%
77	ROPAR	32	DS DIVN. ROPAR	Residential	70943		70943	74%	147.236	147.236	34%	141.99	141.99	24%			0.00%					
				Agricultural	152	10487	10639	11%	0.501	64.231	64.231	15%	0.61	84.50	85.114	20%			0.00%			
				Commercial/Industrial-LT	13178		13178	13%	59.463			14%	57.06		57.062	13%	59.00	8.83%	0.00%			
				Commercial/Industrial-HF	33		33	0%	152.318			35%	296.51		296.507	69%			0.00%			
				Others	77		77	0%	7.17			2%	13.46		13.456	3%	388.48	413.44	100.00%	0.00%		
Sub-total				90582	10487	100069	100%	366.708	64.231	430.939	100%	668.09	524.529	84.503	609.032	100%	59.00	8.83%	388.48	413.44	100.00%	9%
78	ROPAR	32	DS DIVN. SAMRALA	Residential	87283		87283	84%	148.063	148.063	20%	171.05	171.027	11%			0.00%					
				Agricultural	128	23207	23335	19%	0.501	111.268	111.268	17%	0.12	138.75	139.266	9%	80.12	5.09%	0.00%			
				Commercial/Industrial-LT	13112		13112	11%	64.829			9%	59.61		58.614	4%			0.00%			
				Commercial/Industrial-HF	320		320	0%	396.967			55%	1127.11		1122.106	75%			0.00%			
				Others	33		33	0%	0.759			0%	0.759		0.764	0%	1007.56	1084.44	100.00%	0.00%		
Sub-total				100856	23207	124063	100%	611.121	111.268	722.389	100%	1573.01	1394.152	138.745	1492.897	100%	80.12	5.09%	1007.56	1084.44	100.00%	5%
79	SANGRUR	33	DS CITY DIVN. SUNAM	Residential	67101		67101	67%	115.593	115.593	25%	151.40	151.402	27%			0.00%					
				Agricultural	21560	21308	21560	23%	4.463	265.891	265.891	52%	1.43	300.73	302.154	53%			0.00%			
				Commercial/Industrial-LT	11503		11503	5%	56.827			12%	58.611		58.611	10%	127.51	18.17%	0.00%			
				Commercial/Industrial-HF	94		94	0%	30.842			7%	58.69		58.694	10%			0.00%			
				Others	2		2	0%	1.504			0%	1.46		1.464	0%	139.83	412.51	100.00%	0.00%		
Sub-total				78790	21308	100098	100%	205.227	265.891	471.118	100%	701.84	574.597	300.728	874.325	100%	127.51	18.17%	139.83	412.51	100.00%	18%
80	SANGRUR	33	DS DIVN. DIRBA	Residential	43638		43638	67%	61.483	61.483	19%	96.15	96.153	24%			0.00%					
				Agricultural	16259		16259	25%	0	208.72	208.72	66%	0.00	243.92	243.923	60%			0.00%			
				Commercial/Industrial-LT	4901		4901	8%	27.92			7%	29.58		29.583	7%	52.23	11.44%	0.00%			
				Commercial/Industrial-HF	62		62	0%	18.988			0%	34.57		34.574	9%			0.00%			
				Others	2		2	0%	0.015			0%	0.015		0.015	0%	286.09	292.17	100.00%	0.00%		
Sub-total				48603	16259	64862	100%	108.406	208.72	317.126	100%	456.52	360.971	243.923	404.274	100%	52.23	11.44%	286.09	292.17	100.00%	11%
81	SANGRUR	33	DS DIVN. PATRAN	Residential	35490		35490	70%	74.341	74.341	21%	108.67	108.667	23%			0.00%					
				Agricultural	15194		15194	19%	0.123	218.393	218.393	62%	0.52	270.53	271.046	96%			0.00%			
				Commercial/Industrial-LT	8280		8280	10%	36.54			10%	39.38		39.382	8%	178.40	27.06%	0.00%			
				Commercial/Industrial-HF	63		63	0%	24.505			7%	61.37		61.368	13%			0.00%			
				Others	4		4	0%	0.223			0%	0.45		0.449	0%	286.62	352.36	100.00%	0.00%		
Sub-total				63852	15194	79046	100%	135.732	218.393	354.125	100%	658.31	510.384	270.528	480.912	100%	178.40	27.06%	286.62	352.36	100.00%	27%
82	SANGRUR	33	DS DIVN. SANGRUR	Residential	68295		68295	71%	136.274	136.274	29%	179.99	179.985	27%			0.00%					
				Agricultural	180	14244	14324	1%	0.919	182.132	182.132	39%	2.57	221.97	224.542	33%			0.00%			
				Commercial/Industrial-LT	12869		12869	13%	78.039			16%	78.80		78.796	12%	80.91	10.73%	0.00%			
				Commercial																		

88	BATHINDA	40	DS DIVN. MAUR	Residential	101381		101381	73%	130 725		130 725	19%	231.32		231 317	19%		0.00%				
				Agricultural	127	24656	24783	1.9%	1 438	193.623	195.063	28%	4.17	262.72	266.893	22%			0.00%			
				Commercial/Industrial/IT	11853		11853	9%	52 461		52 461	5%	55.65		55 500	5%	114.34	8.52%		0.00%		
				Commercial/Industrial/HT	160		160	0%	307 288		307 288	45%	662.14		663 136	54%				0.00%		
				Others	14		14	0%	4 939		4 939	1%	11.46		11 456	1%				0.00%		
Sub-total				113545	24656	138201	100%	496 851	193.623	690 474	100%	1341.79	964 730	262 721	1227 451	100%	114.34	8.52%	813.35	909.72	100.00%	9%
89	BATHINDA	40	DS DIVN. RAMPURA PHA	Residential	56338		56338	68%	102 152		102 152	28%			124 122	26%		0.00%				
				Agricultural	446	14795	15241	13%	3 689	155 271	158 954	45%	15.49	201.14	216 632	45%			0.00%			
				Commercial/Industrial/IT	10597		10597	13%	38 487		38 487	11%	53.23		53 231	11%	167.58	25.80%		0.00%		
				Commercial/Industrial/HT	110		110	0%	44 242		44 242	12%	82.44		82 439	17%				0.00%		
				Others	14		14	0%	3 492		3 492	1%	7.96		7 964	2%				0.00%		
Sub-total				67526	14795	82321	100%	212 056	155 371	367 427	100%	649.47	280 749	201 141	481 890	100%	167.58	25.80%	338.34	372.33	100.00%	26%
90	FARIDKOT	41	DS CITY DIVN. MOGA	Residential	90249		90249	68%	159 401		159 401	30%			218 742	34%		0.00%				
				Agricultural	57	26344	26401	20%	0 166	266 732	266 898	50%	0 72	302.44	303 156	47%				0.00%		
				Commercial/Industrial/IT	1573		1573	12%	78 507		78 507	2%	77.71		77 705	12%	117.87	17.65%		0.00%		
				Commercial/Industrial/HT	105		105	0%	29 711		29 711	6%	40 372		40 366	6%				0.00%		
				Others	54		54	0%	2 715		2 715	1%	7 215		7 215	1%				0.00%		
Sub-total				106348	26344	132692	100%	270.5	266 732	537 213	100%	781.26	340 943	302 440	643 394	100%	137.87	17.65%	384.11	474.34	100.00%	18%
91	FARIDKOT	41	DS DIVN. BAGHAPURAM	Residential	70296		70296	67%	111 999		111 999	23%			140 520	24%		0.00%				
				Agricultural	154	24836	24990	24%	1 122	285 929	287 049	60%	4 97	332.98	337 956	58%				0.00%		
				Commercial/Industrial/IT	9536		9536	9%	39 283		39 283	8%	37 77		37 773	6%	211.92	26.76%		0.00%		
				Commercial/Industrial/HT	138		138	0%	39 878		39 878	12%	68.80		68 798	12%				0.00%		
				Others	3		3	0%	0 24		0 24	0%	0 48		0 476	0%				0.00%		
Sub-total				80227	24836	105063	100%	192 52	285 929	474 449	100%	799.42	250 521	322 983	585 504	100%	213.92	26.76%	354.92	428.67	100.00%	27%
92	FARIDKOT	41	DS DIVN. FARIDKOT	Residential	72442		72442	70%	123 003		123 003	41%			177 293	33%		0.00%				
				Agricultural	88	21518	21606	21%	0 302	106 76	107 062	35%	0 82	89.14	89 960	26%				0.00%		
				Commercial/Industrial/IT	9894		9894	10%	47 526		47 526	16%	44.04		44 038	13%	77.32	18.06%		0.00%		
				Commercial/Industrial/HT	45		45	0%	15 995		15 995	3%	23.06		23 335	7%				0.00%		
				Others	27		27	0%	8 997		8 997	3%	16 042		16 042	5%				0.00%		
Sub-total				82496	21518	104014	100%	195 823	106 76	302 583	100%	428.19	261 727	89 139	350 866	100%	77.32	18.06%	222.60	259 22	100.00%	18%
93	FARIDKOT	41	DS DIVN. KOTKAPURA	Residential	94104		94104	71%	154 604		154 604	32%			225 700	36%		0.00%				
				Agricultural	80	23662	23742	18%	0 41	207 468	207 878	44%	1 40	236.81	238 211	41%				0.00%		
				Commercial/Industrial/IT	14446		14446	11%	64 101		64 101	14%	55 13		55 134	10%	81.94	12.40%		0.00%		
				Commercial/Industrial/HT	129		129	0%	40 994		40 994	1%	54.81		54 805	10%				0.00%		
				Others	34		34	0%	0 715		0 715	0%	1 30		1 298	0%				0.00%		
Sub-total				108793	23662	132455	100%	260 824	207 468	468 292	100%	661.10	342 340	236 814	579 154	100%	81.94	12.40%	351.54	421 68	100.00%	12%
94	FARIDKOT	41	DS S/U DIVN. MOGA	Residential	66073		66073	70%	113 824		113 824	20%			161 123	28%		0.00%				
				Agricultural	33	17821	17854	19%	0 189	190 323	190 512	44%	0 27	280.56	280 829	47%				0.00%		
				Commercial/Industrial/IT	10546		10546	11%	56 618		56 618	13%	52 36		52 363	9%	57.44	8.84%		0.00%		
				Commercial/Industrial/HT	136		136	0%	96 337		96 337	15%	91 22		91 220	15%				0.00%		
				Others	29		29	0%	0 646		0 646	0%	0 83		0 833	0%				0.00%		
Sub-total				76808	17821	94629	100%	246 614	190 323	436 937	100%	649.84	311 838	280 560	592 398	100%	57.44	8.84%	360.50	431 42	100.00%	9%
95	FEROZPUR	42	DS CITY DIVN. FEROZPUR	Residential	66433		66433	69%	105 959		105 959	24%			150 65	40%		0.00%				
				Agricultural	25	21066	21091	22%	0 081	140 052	140 133	49%	0 34	132 43	132 772	35%				0.00%		
				Commercial/Industrial/IT	9151		9151	44%	44 205		44 205	14%	43 41		43 414	12%	131.28	25.89%		0.00%		
				Commercial/Industrial/HT	35		35	0%	19 133		19 133	6%	40 52		40 520	11%				0.00%		
				Others	33		33	0%	3 5		3 5	0%	8 47		8 473	2%				0.00%		
Sub-total				75677	21066	96743	100%	172 888	140 052	312 94	100%	507.11	244 394	132 433	376 827	100%	131.28	25.89%	234 77	273 96	100.00%	26%
96	FEROZPUR	42	DS DIVN. JALALABAD	Residential	88382		88382	69%	107 217		107 217	31%			165 40	35%		0.00%				
				Agricultural	2180	28187	28187	22%	0 015	153 703	153 718	45%	0 04	196 40	196 448	41%				0.00%		
				Commercial/Industrial/IT	10923		10923	41%	41 312		41 312	12%	32 69		32 691	8%	215.20	31.18%		0.00%		
				Commercial/Industrial/HT	79		79	0%	39 546		39 546	12%	74 02		74 022	16%				0.00%		
				Others	11		11	0%	1 879		1 879	1%	3 15		3 150	1%				0.00%		
Sub-total				99918	28187	127905	100%	189 869	153 703	343 672	100%	690.11	275 506	196 405	474 911	100%	215.20	31.18%	380 96	348 50	100.00%	31%
97	FEROZPUR	42	DS DIVN. ZIRA	Residential	68573		68573	62%	101 604		101 604	20%			134 891	27%		0.00%				
				Agricultural	31	31898	31929	29%	0 234	326 74	326 974	65%	0 18	286 25	286 62	57%				0.00%		
				Commercial/Industrial/IT	9043		9043	8%	45 79		45 79	1%	45 03		45 026	9%	288.64	36.53%		0.00%		
				Commercial/Industrial/HT	111		111	0%	28 574		28 574	8%	33 18		33 177	7%				0.00%		
				Others	63		63	0%	0 706		0 706	0%	1 76		1 762	0%				0.00%		
Sub-total				77820	31898	109718	100%	176 888	326 74	303 528	100%	790.12	215 233	286 247	501 478	100%	288.64	36.53%	300 60	382 62	100.00%	37%
98	FEROZPUR	42	DS S/U DIVN. FEROZPUR	Residential	53529		53529	66%	67 123		67 123	32%			103 52	38%		0.00%				
				Agricultural	24	18812	18836	23%	0 085	93 039	93 124	33%	0 22	100 88	101 104	37%				0.00%		
				Commercial/Industrial/IT	8204		8204	10%	27 478		27 478	13%	27 26		27 265	10%	127.72	31.89%		0.00%		
				Commercial/Industrial/HT	14		14	0%	3 752		3 752	2%	4 79		4 792	2%				0.00%		
				Others	39		39	0%	16 793		16 793	8%	35 563		35 563	13%				0.00%		
Sub-total				61810	18812	80622	100%	115 23	93 039	208 295	100%	400.44	171 842	100 842	272 724	100%	127.72	31.89%	166 94	190 48	100.00%	32%
99	MUKATSAR	43	DS DIVN. ABOHAR	Residential	101106		101106	83%	142 548		142 548	57%			195 934	64%		0.00%				
				Agricultural	56	6941	6997	6%	0 232	29 442	29 664	12%	0 00	28 26	28 259	9%				0.00%		
				Commercial/Industrial/IT	14443		14443	12%	60 948		60 948	24%	54 72		54 718	18%	112.85	30.16%		0.00%		
				Commercial/Industrial/HT	48		48	0%	15 522		15 522	6%	20 32		20 324	7%				0.00%		
				Others	11		11	0%	2 655		2 655	1%	8 46		8 456	3%				0.00%		
Sub-total				115862	6941	122803	100%	221 905	29 442	251 337	100%	440.55	279 432	28 259	307 691	100%	112.85	30.16%	213.10	238 27	100.00%	30%
100	MUK																					

Form-Input energy(Details of Input energy & Infrastructure)
A. Summary of energy input & Infrastructure

S.No	Parameters	Period From 01.04.2022 To 31.03.2023	Remarks (Source of data)
A.1	Input Energy purchased (MU)	70329	Historical data
A.2	Transmission loss (%)	5.93%	
A.3	Transmission loss (MU)	4188.35	1440.37+2728.69 (Inter State+Intra state)
A.4	Energy sold outside the periphery(MU)	481.47	380.24(Historical data sheet)+103.23(BBM& Common pool Share)
A.5	Open access sale (MU)	0.2	(0.18+0.02)Historical data
A.6	EHT sale		
A.7	Net input energy (received at DISCOM periphery or at distribution point)-(MU)	66160	
A.8	Is 100% metering available at 66/33 KV (Select yes or no from list)	Yes	
A.9	Is 100% metering available at 11 KV (Select yes or no from list)	Yes	
A.10	% of metering available at DT		Completion of the HVDS/Pillar Box installation in the AP/DS consumers may obviate the need for "Separate" DT meter installation due to virtually LT-less LD system
A.11	% of metering available at consumer end	86.85%	
A.12	No of Feeders at 66KV and above voltage level	168	Director/D
A.13	No of feeders at 33KV voltage level	5	Director/D
A.14	No of feeders at 11KV voltage level	12975	Director/D
A.15	No of LT feeders level		
A.16	Line length (ckt. km) at 66KV voltage level	14289	Planning
A.17	Line length (ckt. km) at 33KV voltage level	71	Planning
A.18	Line length (ckt. km) at 11KV voltage level	252006	Planning
A.19	Line length (km) at LT level	153732	Planning
A.20	Length of Aerial Bunches Cables	NA	NA
A.21	Length of Underground Cables	NA	NA
A.22	HT/LT ratio	1.64	

B. Meter reading of input energy at injection points

S.No	Zone	Circle	Voltage Level (KVA)	Division (KVA)	Sub-Division (KVA)	Feeder ID	Feeder Name	Feeder Metering Name (Metered/unmetered/ AMU/AMR)	Status of Meter (Functional/Non-functional)	Metering Date	Feeder Type (Agri/ Industrial/Mixed)	% data received through automatically if feeder AMR/AMU	Number of hours when meter was unable to communicate in crucial	Total Number of hours in the period	Period from 01.04.2021to 31.03.2022				Sales	Remarks (Source of data)
															Meter S.No	CT/PT ratio	Import (MU)	Export (MU)		
B.1	Border	CITY AMRITSAR	11KV	DS CITY CENTER DIVN.	DS S/D GHEE MANDI TECH. ASR	C751FL03	11KV NEW GOLDEN AVENUE	AMR	OK	31.03.2023	Category 1				7042899	900-450/577/1-1-1	5.220	NA	Director/D	
B.2	Border	CITY AMRITSAR	11KV	DS CITY CENTER DIVN.	DS S/D GHEE MANDI TECH. ASR	C751FL01	HUSSAINPURA	AMR	OK	31.03.2023	Category 1				5483702	900-450/577/1-1-1	7.434	NA	Director/D	
B.3	Border	CITY AMRITSAR	11KV	DS CITY CENTER DIVN.	DS S/D GHEE MANDI TECH. ASR	C751FL02	Head Water Works Road	AMR	OK	31.03.2023	Category 1				6675550	900-450/577/1-1-1	8.306	NA	Director/D	
B.4	Border	CITY AMRITSAR	11KV	DS CITY CENTER DIVN.	DS S/D GHEE MANDI TECH. ASR	C751FL08	11KV New Ravi Dass Road	AMR	OK	31.03.2023	Category 1				2046495	1200/577/1-1-1	10.577	NA	Director/D	
B.5	Border	CITY AMRITSAR	11KV	DS CITY CENTER DIVN.	DS S/D GHEE MANDI TECH. ASR	C754FL13	11KV NEW KESRI BAGH	AMR	OK	31.03.2023	Category 1				198076	1200/577/1-1-1	2.649	NA	Director/D	
B.6	Border	CITY AMRITSAR	11KV	DS CITY CENTER DIVN.	DS S/D GHEE MANDI TECH. ASR	C754FL02	11KV Ghee Mandi 2	AMR	OK	31.03.2023	Category 1				4180050	1200/577/1-1-1	5.263	NA	Director/D	
B.7	Border	CITY AMRITSAR	11KV	DS CITY CENTER DIVN.	DS S/D GHEE MANDI TECH. ASR	C754FL01	11kv keori Bagh	AMR	OK	31.03.2023	Category 1				6740734	1200/577/1-1-1	5.869	NA	Director/D	
B.8	Border	CITY AMRITSAR	11KV	DS CITY CENTER DIVN.	DS S/D GHEE MANDI TECH. ASR	C754FL09	11 KV MOTI BAZAR	AMR	OK	31.03.2023	Category 1				13685	1200/577/1-1-1	6.132	NA	Director/D	
B.9	Border	CITY AMRITSAR	11KV	DS CITY CENTER DIVN.	DS S/D GHEE MANDI TECH. ASR	C754FL04	11kv Chhattwind	AMR	OK	31.03.2023	Category 1				2993713	1200/577/1-1-1	6.518	NA	Director/D	
B.10	Border	CITY AMRITSAR	11KV	DS CITY CENTER DIVN.	DS S/D GHEE MANDI TECH. ASR	C754FL03	11kv Navdeep Theatre	AMR	OK	31.03.2023	Category 1				4221178	1200/577/1-1-1	6.538	NA	Director/D	
B.11	Border	CITY AMRITSAR	11KV	DS CITY CENTER DIVN.	DS S/D GHEE MANDI TECH. ASR	C751FL19	11 KESRI BAGH HG	AMR	OK	31.03.2023	Category 1				198080	1200/577/1-1-1	0.000	NA	Director/D	
B.12	Border	CITY AMRITSAR	11KV	DS CITY CENTER DIVN.	DS S/D GHEE MANDI TECH. ASR	C751FL20	DHARAM SINGH MKRT INTERLINK	AMR	OK	31.03.2023	Category 1				197931	1200/577/1-1-1	0.000	NA	Director/D	
B.13	Border	CITY AMRITSAR	11KV	DS CITY CENTER DIVN.	DS S/D HUSSAINPURA TECH. ASR	C754FL12	BHARAWA DA DHABHA	AMR	OK	31.03.2023	Category 1				36961	1200/577/1-1-1	0.000	NA	Director/D	
B.14	Border	CITY AMRITSAR	11KV	DS CITY CENTER DIVN.	DS S/D HUSSAINPURA TECH. ASR	C754FL14	11 KV SUBAHS PARK	AMR	OK	31.03.2023	Category 1				197948	1200/577/1-1-1	0.000	NA	Director/D	
B.15	Border	CITY AMRITSAR	11KV	DS CITY CENTER DIVN.	DS S/D HUSSAINPURA TECH. ASR	C754FL15	11 KV MASHI MANDI	NON AMR	OK	31.03.2023	Category 1				34057	1200/577/1-1-1	0.000	NA	Director/D	
B.16	Border	CITY AMRITSAR	11KV	DS CITY CENTER DIVN.	DS S/D HUSSAINPURA TECH. ASR	C754FL26	Karion Market	AMR	OK	31.03.2023	Category 1				197839	1200/577/1-1-1	0.000	NA	Director/D	
B.17	Border	CITY AMRITSAR	11KV	DS CITY CENTER DIVN.	DS S/D HUSSAINPURA TECH. ASR	C754FL13	11 KV TOWN HALL	AMR	OK	31.03.2023	Category 1				33683	1200/577/1-1-1	1.627	NA	Director/D	
B.18	Border	CITY AMRITSAR	11KV	DS CITY CENTER DIVN.	DS S/D HUSSAINPURA TECH. ASR	C754FL05	Cheel Mandi	AMR	OK	31.03.2023	Category 1				33714	1200/577/1-1-1	9.391	NA	Director/D	
B.19	Border	CITY AMRITSAR	11KV	DS CITY CENTER DIVN.	DS S/D HUSSAINPURA TECH. ASR	C751FL10	11KV Hussainpura	AMR	OK	31.03.2023	Category 1				7042833	1200/577/1-1-1	10.334	NA	Director/D	
B.20	Border	CITY AMRITSAR	11KV	DS CITY CENTER DIVN.	DS S/D HUSSAINPURA TECH. ASR	C751FL04	11kv Hall Bazar	AMR	OK	31.03.2023	Category 1				3065834	1200/577/1-1-1	0.000	NA	Director/D	
B.21	Border	CITY AMRITSAR	11KV	DS CITY CENTER DIVN.	DS S/D HUSSAINPURA TECH. ASR	C751FL10	11 KV Katra Baghian	AMR	OK	31.03.2023	Category 1				6761900	1200/577/1-1-1	0.000	NA	Director/D	
B.22	Border	CITY AMRITSAR	11KV	DS CITY CENTER DIVN.	DS S/D HUSSAINPURA TECH. ASR	C751FL14	11KV Civil Hospital Independent	AMR	OK	31.03.2023	Category 2				9154108	1200/577/1-1-1	1.213	NA	Director/D	
B.23	Border	CITY AMRITSAR	11KV	DS CITY CENTER DIVN.	DS S/D HUSSAINPURA TECH. ASR	C751FL23	MASHI MANDI	AMR	OK	31.03.2023	Category 1				197891	1200/577/1-1-1	1.692	NA	Director/D	
B.24	Border	CITY AMRITSAR	11KV	DS CITY CENTER DIVN.	DS S/D HUSSAINPURA TECH. ASR	C751FL22	BHARAWA DA DHABHA	AMR	OK	31.03.2023	Category 1				7164577	1200/577/1-1-1	1.385	NA	Director/D	
B.25	Border	CITY AMRITSAR	11KV	DS CITY CENTER DIVN.	DS S/D HUSSAINPURA TECH. ASR	C751FL25	SUBASHI PARK	NON AMR	OK	31.03.2023	Category 1				73161875	1200/577/1-1-1	2.496	NA	Director/D	
B.26	Border	CITY AMRITSAR	11KV	DS CITY CENTER DIVN.	DS S/D HUSSAINPURA TECH. ASR	C751FL24	KARION MARKET	AMR	OK	31.03.2023	Category 1				197838	1200/577/1-1-1	3.567	NA	Director/D	
B.27	Border	CITY AMRITSAR	11KV	DS CITY CENTER DIVN.	DS S/D HUSSAINPURA TECH. ASR	C751FL21	TOWN HALL	AMR	OK	31.03.2023	Category 1				197886	1200/577/1-1-1	4.111	NA	Director/D	
B.28	Border	CITY AMRITSAR	11KV	DS CITY CENTER DIVN.	DS S/D HUSSAINPURA TECH. ASR	C751FL07	11kv saraswati	AMR	OK	31.03.2023	Category 1				3067573	1200/577/1-1-1	4.632	NA	Director/D	
B.29	Border	CITY AMRITSAR	11KV	DS CITY CENTER DIVN.	DS S/D HUSSAINPURA TECH. ASR	C751FL02	11KV Ram Bagh	NON AMR	OK	31.03.2023	Category 1				3067982	1200/577/1-1-1	6.936	NA	Director/D	
B.30	Border	CITY AMRITSAR	11KV	DS CITY CENTER DIVN.	DS S/D MALL MANDI TECH. ASR	C751DL11	11 KV Bhai Gurdas Ji Nagar	AMR	OK	31.03.2023	Category 1				5475	1200/577/1-1-1	4.101	NA	Director/D	
B.31	Border	CITY AMRITSAR	11KV	DS CITY CENTER DIVN.	DS S/D MALL MANDI TECH. ASR	C751FL14	Kapoor Nagar	AMR	OK	31.03.2023	Category 1				9154236	1200/577/1-1-1	7.299	NA	Director/D	
B.32	Border	CITY AMRITSAR	11KV	DS CITY CENTER DIVN.	DS S/D MALL MANDI TECH. ASR	C751FL13	Gobind Nagar	AMR	OK	31.03.2023	Category 1				5343286	900-450/577/1-1-1	13.171	NA	Director/D	
B.33	Border	CITY AMRITSAR	11KV	DS CITY CENTER DIVN.	DS S/D MALL MANDI TECH. ASR	C801FL03	J C MOTOR	AMR	OK	31.03.2023	Category 2				2046990	1200/577/1-1-1	0.000	NA	Director/D	
B.34	Border	CITY AMRITSAR	11KV	DS CITY CENTER DIVN.	DS S/D MALL MANDI TECH. ASR	C801FL2	KHANKOT	AMR	OK	31.03.2023	Category 1				2068199	1200/577/1-1-1	1.631	NA	Director/D	
B.35	Border	CITY AMRITSAR	11KV	DS CITY CENTER DIVN.	DS S/D MALL MANDI TECH. ASR	C801FL08	Byepass	AMR	OK	31.03.2023	Category 1				10288333	1200/577/1-1-1	5.553	NA	Director/D	
B.36	Border	CITY AMRITSAR	11KV	DS CITY CENTER DIVN.	DS S/D MALL MANDI TECH. ASR	C801FL05	GT road	AMR	OK	31.03.2023	Category 1				11052041	1200/577/1-1-1	11.540	NA	Director/D	
B.37	Border	CITY AMRITSAR	11KV	DS CITY CENTER DIVN.	DS S/D MALL MANDI TECH. ASR	C801FL04	Bhai Lalaji Nagar	AMR	OK	31.03.2023	Category 1				11052009	1200/577/1-1-1	13.391	NA	Director/D	
B.38	Border	CITY AMRITSAR	11KV	DS CITY CENTER DIVN.	DS S/D MALL MANDI TECH. ASR	C801FL13	GTFC FOCAL POINT	AMR	OK	31.03.2023	Category 2				10282977	1200/577/1-1-1	13.879	NA	Director/D	
B.39	Border	CITY AMRITSAR	11KV	DS CITY CENTER DIVN.	DS S/D MALL MANDI TECH. ASR	C801FL10	New Focal point	AMR	OK	31.03.2023	Category 2				11081970	1200/577/1-1-1	14.696	NA	Director/D	
B.40	Border	CITY AMRITSAR	11KV	DS CITY CENTER DIVN.	DS S/D MALL MANDI TECH. ASR	C801FL11	New Amritsar	AMR	OK	31.03.2023	Category 1				11057979	1200/577/1-1-1	15.829	NA	Director/D	
B.41	Border	CITY AMRITSAR	11KV	DS CITY CENTER DIVN.	DS S/D MALL MANDI TECH. ASR	C801FL02	Fogpoint old	AMR	OK	31.03.2023	Category 1				10281977	1200/577/1-1-1	23.059	NA	Director/D	
B.42	Border	CITY AMRITSAR	11KV	DS CITY CENTER DIVN.	DS S/D MALL MANDI TECH. ASR	C945FL04	Bhai Chanayia Ji	AMR	OK	31.03.2023	Category 1				73142114	1200/577/1-1-1	2.330	NA	Director/D	
B.43	Border	CITY AMRITSAR	11KV	DS CITY CENTER DIVN.	DS S/D MALL MANDI TECH. ASR	C945SL01	BABA DEEP SINGH	NON AMR	OK	31.03.2023	Category 1				33849	1200/577/1-1-1	7.942	NA	Director/D	
B.44	Border	CITY AMRITSAR	11KV	DS CITY CENTER DIVN.	DS S/D MALL MANDI TECH. ASR	845FL08	11 KV SULTANWIND-1	AMR	OK	31.03.2023	Category 1				33833	1200/577/1-1-1	11.035	NA	Director/D	
B.45	Border	CITY AMRITSAR	11KV	DS CITY CENTER DIVN.	DS S/D MALL MANDI TECH. ASR	C945SL05	BABA BUDHA Ji	NON AMR	OK	31.03.2023	Category 1				33830	1200/577/1-1-1	11.478	NA	Director/D	
B.46	Border	CITY AMRITSAR	11KV	DS CITY CENTER DIVN.	DS S/D MALL MANDI TECH. ASR	845FL07	11KV DABALI	AMR	OK	31.03.2023	Category 1				1956496	1200/577/1-1-1	12.366	NA	Director/D	
B.47	Border	CITY AMRITSAR	11KV	DS CITY CENTER DIVN.	DS S/D MALL MANDI TECH. ASR	C945SL02	ATTARI SAHIB	AMR	OK	31.03.2023	Category 1				33845	1200/577/1-1-1	16.310	NA	Director/D	
B.48	Border	CITY AMRITSAR	11KV	DS CITY CENTER DIVN.	DS S/D MALL MANDI TECH. ASR	C803FL10	11 KV WALLEH	Not available	OK	31.03.2023	Category 1				1716	900-450/577/1-1-1	12.843	NA	Director/D	
B.49	Border	CITY AMRITSAR	66KV	DS CITY CENTER DIVN.	DS S/D MALL MANDI TECH. ASR	C751DL01	Apha G	AMR	OK	31.03.2023	Category 1				Not available	Not available	13.273	NA	Director/D	
B.50	Border	CITY AMRITSAR	11KV	DS CIVIL LINE DIVN.	ASR DS S/D CIVIL LINE TECH., ASR	C846FL05	BEAUTY AVENUE	AMR	OK	31.03.2023	Category 1				536425	1200/577/1-1-1	6.863	NA	Director/D	
B.51	Border	CITY AMRITSAR	11KV	DS CIVIL LINE DIVN.	ASR DS S/D CIVIL LINE TECH., ASR	C755FL08	DNT	AMR	OK	31.03.2023	Category 1				6675129	1200/5				

S.No	Zone	Circle	Voltage Level (kVA)	Division (kVA)	Sub-Division (kVA)	Feeder ID	Feeder Name	Feeder Metering Status (Metered/unmetered/AMR/AMI)	Status of Meter (Functional/Non-Functional)	Metering Date (Date of last actual meter reading/communication)	Feeder Type (Agr/Industrial/Mixed)	Status of Communication			Period from 01.04.2021 to 31.03.2022				Sales	Remarks (Source of data)
												% data received through automatically by feeder AMR/AMI	Number of hours when meter was unable to communicate in overall	Total Number of hours in the period	Meter S.No	CT/PT ratio	Import (kU)	Export (kU)		
B.67	Border	CITY AMRITSAR	11KV	DS CIVIL LINE DIVN.	ASR DS S/D ISLAMABAD TECH., ASR	0383F02	BHANDARI CHOWK	AMR	OK	31.03.2023	Category 1				33672	1200/577/1-1-1	8.520	NA	Director/D	
B.68	Border	CITY AMRITSAR	11KV	DS CIVIL LINE DIVN.	ASR DS S/D ISLAMABAD TECH., ASR	0383F04	KHOOD BHALLA	AMR	OK	31.03.2023	Category 1				73141869	1200/577/1-1-1	10.889	NA	Director/D	
B.69	Border	CITY AMRITSAR	11KV	DS CIVIL LINE DIVN.	ASR DS S/D ISLAMABAD TECH., ASR	0383F08	NAVAMOTI	AMR	OK	31.03.2023	Category 1				33679	1200/577/1-1-1	11.911	NA	Director/D	
B.70	Border	CITY AMRITSAR	11KV	DS CIVIL LINE DIVN.	ASR DS S/D ISLAMABAD TECH., ASR	0383F05	DHAPAI INDUSTRIAL	AMR	OK	31.03.2023	Category 1				33681	1200/577/1-1-1	15.454	NA	Director/D	
B.71	Border	CITY AMRITSAR	11KV	DS CIVIL LINE DIVN.	ASR DS S/D ISLAMABAD TECH., ASR	0753F04	CHAH NHANGA	AMR	OK	31.03.2023	Category 1				7336403	1200-600/5	0.000	NA	Director/D	
B.72	Border	CITY AMRITSAR	11KV	DS CIVIL LINE DIVN.	ASR DS S/D ISLAMABAD TECH., ASR	0753F05	RLP WORKSHOP	AMR	OK	31.03.2023	Category 1				7042956	1200-600/5	1.163	NA	Director/D	
B.73	Border	CITY AMRITSAR	11KV	DS CIVIL LINE DIVN.	ASR DS S/D ISLAMABAD TECH., ASR	0753F06	CANAL OFFICE	AMR	OK	31.03.2023	Category 1				7463625	1200-600/5	5.830	NA	Director/D	
B.74	Border	CITY AMRITSAR	11KV	DS CIVIL LINE DIVN.	ASR DS S/D ISLAMABAD TECH., ASR	0753F08	Jwadehi mill	AMR	OK	31.03.2023	Category 1				2407185	1200-600/5	9.592	NA	Director/D	
B.75	Border	CITY AMRITSAR	11KV	DS CIVIL LINE DIVN.	ASR DS S/D ISLAMABAD TECH., ASR	0753F16	RAILWAY STATION	AMR	OK	31.03.2023	Category 2				15174877	1200/577/1-1-1	2.406	NA	Director/D	
B.76	Border	CITY AMRITSAR	11KV	DS CIVIL LINE DIVN.	ASR DS S/D LAWRENCE ROAD TECH., ASR	0846F01	Dasontha Singh Road	AMR	OK	31.03.2023	Category 1				526423	1200/577/1-1-1	6.251	NA	Director/D	
B.77	Border	CITY AMRITSAR	11KV	DS CIVIL LINE DIVN.	ASR DS S/D LAWRENCE ROAD TECH., ASR	0846F04	Guru Nanak Dev Hospital	AMR	OK	31.03.2023	Category 1				526429	1200/577/1-1-1	9.503	NA	Director/D	
B.78	Border	CITY AMRITSAR	11KV	DS CIVIL LINE DIVN.	ASR DS S/D LAWRENCE ROAD TECH., ASR	0752F08	MEDICAL COLLEGE	AMR	OK	31.03.2023	Category 2				7336853	1200/577/1-1-1	0.786	NA	Director/D	
B.79	Border	CITY AMRITSAR	11KV	DS CIVIL LINE DIVN.	ASR DS S/D LAWRENCE ROAD TECH., ASR	0752F11	CIRCULAR ROAD	AMR	OK	31.03.2023	Category 1				2994137	1200/577/1-1-1	2.619	NA	Director/D	
B.80	Border	CITY AMRITSAR	11KV	DS CIVIL LINE DIVN.	ASR DS S/D LAWRENCE ROAD TECH., ASR	0752F13	COMPANY BAGH	AMR	OK	31.03.2023	Category 1				5388132	1200/577/1-1-1	4.582	NA	Director/D	
B.81	Border	CITY AMRITSAR	11KV	DS CIVIL LINE DIVN.	ASR DS S/D LAWRENCE ROAD TECH., ASR	0752F19	SANT AVENUE	AMR	OK	31.03.2023	Category 1				44995	1200/577/1-1-1	4.683	NA	Director/D	
B.82	Border	CITY AMRITSAR	11KV	DS CIVIL LINE DIVN.	ASR DS S/D LAWRENCE ROAD TECH., ASR	0752F02	V.J.HOSPITAL	AMR	OK	31.03.2023	Category 1				5388189	1200/577/1-1-1	4.991	NA	Director/D	
B.83	Border	CITY AMRITSAR	11KV	DS CIVIL LINE DIVN.	ASR DS S/D LAWRENCE ROAD TECH., ASR	0752F15	MALL ROAD	AMR	OK	31.03.2023	Category 1				15193726	1200-600/5	6.300	NA	Director/D	
B.84	Border	CITY AMRITSAR	11KV	DS CIVIL LINE DIVN.	ASR DS S/D LAWRENCE ROAD TECH., ASR	0752F09	SHIVALA ROAD	AMR	OK	31.03.2023	Category 1				23803	1200-600/5	6.487	NA	Director/D	
B.85	Border	CITY AMRITSAR	11KV	DS CIVIL LINE DIVN.	ASR DS S/D LAWRENCE ROAD TECH., ASR	0752F17	Tilak Nagar	AMR	OK	31.03.2023	Category 1				33824	1200-600/5	7.065	NA	Director/D	
B.86	Border	CITY AMRITSAR	11KV	DS CIVIL LINE DIVN.	ASR DS S/D LAWRENCE ROAD TECH., ASR	0752F05	JOSH COLONY	AMR	OK	31.03.2023	Category 1				7034561	1200/577/1-1-1	7.166	NA	Director/D	
B.87	Border	CITY AMRITSAR	11KV	DS CIVIL LINE DIVN.	ASR DS S/D LAWRENCE ROAD TECH., ASR	0752F14	malhiya road	NON AMR	OK	31.03.2023	Category 1				6772299	1200/577/1-1-1	8.178	NA	Director/D	
B.88	Border	CITY AMRITSAR	11KV	DS CIVIL LINE DIVN.	ASR DS S/D LAWRENCE ROAD TECH., ASR	0752F06	ADARSH	AMR	OK	31.03.2023	Category 1				33487	1200/577/1-1-1	8.427	NA	Director/D	
B.89	Border	CITY AMRITSAR	11KV	DS CIVIL LINE DIVN.	ASR DS S/D LAWRENCE ROAD TECH., ASR	0752F16	Queens Road	AMR	OK	31.03.2023	Category 1				5463605	1200/577/1-1-1	8.808	NA	Director/D	
B.90	Border	CITY AMRITSAR	11KV	DS CIVIL LINE DIVN.	ASR DS S/D LAWRENCE ROAD TECH., ASR	0752F03	BATALA ROAD	AMR	OK	31.03.2023	Category 1				33456	1200-600/5	8.844	NA	Director/D	
B.91	Border	CITY AMRITSAR	11KV	DS CIVIL LINE DIVN.	ASR DS S/D LAWRENCE ROAD TECH., ASR	0752F10	Lawrence Road	AMR	OK	31.03.2023	Category 1				2066364	1200/577/1-1-1	10.091	NA	Director/D	
B.92	Border	CITY AMRITSAR	11KV	DS CIVIL LINE DIVN.	ASR DS S/D LAWRENCE ROAD TECH., ASR	0752F12	KRISHNA NAGAR	AMR	OK	31.03.2023	Category 1				2066270	1200/577/1-1-1	10.351	NA	Director/D	
B.93	Border	CITY AMRITSAR	11KV	DS CIVIL LINE DIVN.	ASR DS S/D LAWRENCE ROAD TECH., ASR	0752F04	MAQBOOL ROAD	AMR	OK	31.03.2023	Category 1				6676503	1200/577/1-1-1	4.971	NA	Director/D	
B.94	Border	CITY AMRITSAR	11KV	DS CIVIL LINE DIVN.	ASR DS S/D LAWRENCE ROAD TECH., ASR	0801F08	MAQBOOL ROAD	AMR	OK	31.03.2023	Category 1				2066750	1200/577/1-1-1	7.614	NA	Director/D	
B.95	Border	CITY AMRITSAR	11KV	DS DIVN. HAKIMA GATE	DS S/D DURGIANA TEMPLE TECH., ASR	0751F17	11 KV Durgiana Temple	AMR	OK	31.03.2023	Category 4				15194786	1200/577/1-1-1	0.618	NA	Director/D	
B.96	Border	CITY AMRITSAR	11KV	DS DIVN. HAKIMA GATE	DS S/D DURGIANA TEMPLE TECH., ASR	0751F03	11KV Gagar Mal	AMR	OK	31.03.2023	Category 1				5463655	1200/577/1-1-1	2.047	NA	Director/D	
B.97	Border	CITY AMRITSAR	11KV	DS DIVN. HAKIMA GATE	DS S/D DURGIANA TEMPLE TECH., ASR	0751F18	11kv Vr sher singh Duplicate	AMR	OK	31.03.2023	Category 1				198079	1200/577/1-1-1	2.284	NA	Director/D	
B.98	Border	CITY AMRITSAR	11KV	DS DIVN. HAKIMA GATE	DS S/D DURGIANA TEMPLE TECH., ASR	0751F08	11KV KASTI BAGH	AMR	OK	31.03.2023	Category 1				5295600	1200/577/1-1-1	3.820	NA	Director/D	
B.99	Border	CITY AMRITSAR	11KV	DS DIVN. HAKIMA GATE	DS S/D DURGIANA TEMPLE TECH., ASR	0751F13	11kv Katrina Jaimal singh	AMR	OK	31.03.2023	Category 1				2067045	1200/577/1-1-1	4.013	NA	Director/D	
B.100	Border	CITY AMRITSAR	11KV	DS DIVN. HAKIMA GATE	DS S/D DURGIANA TEMPLE TECH., ASR	0751F01	11kv Katrina Moti Ram	AMR	OK	31.03.2023	Category 1				3068193	1200/577/1-1-1	4.941	NA	Director/D	
B.101	Border	CITY AMRITSAR	11KV	DS DIVN. HAKIMA GATE	DS S/D DURGIANA TEMPLE TECH., ASR	0751F12	11KVToDha Bai Sual	AMR	OK	31.03.2023	Category 1				2067944	1200/577/1-1-1	5.608	NA	Director/D	
B.102	Border	CITY AMRITSAR	11KV	DS DIVN. HAKIMA GATE	DS S/D DURGIANA TEMPLE TECH., ASR	0751F05	11kvKatrina Sher Singh	AMR	OK	31.03.2023	Category 1				3067984	1200/577/1-1-1	8.906	NA	Director/D	
B.103	Border	CITY AMRITSAR	11KV	DS DIVN. HAKIMA GATE	DS S/D HAKIMA GATE TECH., ASR	C752F09	11 KV Bhagwalia	AMR	OK	31.03.2023	Category 1				8282080	1200/577/1-1-1	1.455	NA	Director/D	
B.104	Border	CITY AMRITSAR	11KV	DS DIVN. HAKIMA GATE	DS S/D HAKIMA GATE TECH., ASR	C752F17	11 KV Akara Kallu	AMR	OK	31.03.2023	Category 1				33687	1200/577/1-1-1	7.624	NA	Director/D	
B.105	Border	CITY AMRITSAR	11KV	DS DIVN. HAKIMA GATE	DS S/D HAKIMA GATE TECH., ASR	C752F18	11 KV Bhatian	AMR	OK	31.03.2023	Category 1				33686	1200/577/1-1-1	8.415	NA	Director/D	
B.106	Border	CITY AMRITSAR	11KV	DS DIVN. HAKIMA GATE	DS S/D HAKIMA GATE TECH., ASR	C752F16	11 KV Gurbux Nagar	AMR	OK	31.03.2023	Category 1				33686	1200/577/1-1-1	9.323	NA	Director/D	
B.107	Border	CITY AMRITSAR	11KV	DS DIVN. HAKIMA GATE	DS S/D HAKIMA GATE TECH., ASR	C752F06	11 KV Lahori Gate	AMR	OK	31.03.2023	Category 1				2066834	1200/577/1-1-1	11.233	NA	Director/D	
B.108	Border	CITY AMRITSAR	11KV	DS DIVN. HAKIMA GATE	DS S/D HAKIMA GATE TECH., ASR	C752F10	11 KV Chabbi Road	AMR	OK	31.03.2023	Category 1				2066587	1200/577/1-1-1	11.342	NA	Director/D	
B.109	Border	CITY AMRITSAR	11KV	DS DIVN. HAKIMA GATE	DS S/D HAKIMA GATE TECH., ASR	C752F05	11 KV Peer Shah Road	AMR	OK	31.03.2023	Category 1				5295697	1200/577/1-1-1	13.989	NA	Director/D	
B.110	Border	CITY AMRITSAR	11KV	DS DIVN. HAKIMA GATE	DS S/D HAKIMA GATE TECH., ASR	C752F02	11 KV disposal	AMR	OK	31.03.2023	Category 1				2066323	1200/577/1-1-1	22.941	NA	Director/D	
B.111	Border	CITY AMRITSAR	11KV	DS DIVN. HAKIMA GATE	DS S/D TUNDA TALAB TECH., ASR	C753F07	Beri Gate	AMR	OK	31.03.2023	Category 1				2067811	1200/577/1-1-1	0.002	NA	Director/D	
B.112	Border	CITY AMRITSAR	11KV	DS DIVN. HAKIMA GATE	DS S/D TUNDA TALAB TECH., ASR	C753F14	11 KV Katrina Mohar Singh	AMR	OK	31.03.2023	Category 1				2066897	1200/577/1-1-1	5.851	NA	Director/D	
B.113	Border	CITY AMRITSAR	11KV	DS DIVN. HAKIMA GATE	DS S/D TUNDA TALAB TECH., ASR	C752F04	11 KV Dhab Tili Bhanna	AMR	OK	31.03.2023	Category 1				4187171	1200/577/1-1-1	6.535	NA	Director/D	
B.114	Border	CITY AMRITSAR	11KV	DS DIVN. HAKIMA GATE	DS S/D TUNDA TALAB TECH., ASR	C752F12	11 KV Manak Memdi	AMR	OK	31.03.2023	Category 1				2066279	1200/577/1-1-1	8.206	NA	Director/D	
B.115	Border	CITY AMRITSAR	11KV	DS DIVN. HAKIMA GATE	DS S/D TUNDA TALAB TECH., ASR	C753F08	11 KV Tunda Talab	AMR	OK	31.03.2023	Category 1				2066650	1200/577/1-1-1	11.207	NA	Director/D	
B.116	Border	CITY AMRITSAR	11KV	DS DIVN. HAKIMA GATE	DS S/D TUNDA TALAB TECH., ASR	0754F07	11 KV Gokil Temple	AMR	OK	31.03.2023	Category 1				36772	1200/577/1-1-1	7.638	NA	Director/D	
B.117	Border	CITY AMRITSAR	11KV	DS DIVN. HAKIMA GATE	DS S/D TUNDA TALAB TECH., ASR	0751F11	11 KV Beri Gate	AMR	OK	31.03.2023	Category 1				2047166	1200/577/1-1-1	6.257	NA	Director/D	
B.118	Border	CITY AMRITSAR	11KV	DS DIVN. HAKIMA GATE	DS S/D TUNDA TALAB TECH., ASR	0751F15	B-K DUTT Gate	AMR	OK	31.03.2023	Category 1				564579	1200/577/1-1-1	8.092	NA	Director/D	
B.119	Border	CITY AMRITSAR	11KV	DS DIVN. INDUSTRIAL	ASR DS GOLDEN TEMPLE TECH., ASR	C751F05	shri guru ram dass	AMR	OK	31.03.2023	Category 1				8223235	1200/577/1-1-1	12.942	NA	Director/D	
B.120	Border	CITY AMRITSAR	11KV	DS DIVN. INDUSTRIAL	ASR DS GOLDEN TEMPLE TECH., ASR	C753F03	Shri guru ram dass hospital	AMR	OK	31.03.2023	Category 1				2067342	1200/577/1-1-1	3.749	NA	Director/D	
B.121	Border	CITY AMRITSAR	11KV	DS DIVN. INDUSTRIAL	ASR DS GOLDEN TEMPLE TECH., ASR	C753F11	Shri guru ram dass hospital	AMR	OK	31.03.2023	Category 2				2046557	1200/577/1-1-1	2.749	NA	Director/D	
B.122	Border	CITY AMRITSAR	11KV	DS DIVN. INDUSTRIAL	ASR DS GOLDEN TEMPLE TECH., ASR	C753F09	LAXMAN SAR	AMR	OK	31.03.2023	Category 1				2067328	1200/577/1-1-1	6.433	NA	Director/D	
B.123	Border	CITY AMRITSAR	11KV	DS DIVN. INDUSTRIAL	ASR DS GOLDEN TEMPLE TECH., ASR	C753F10	NEW DHAB BASTI RAM	AMR	OK	31.03.2023	Category 1				4187106	1200/577/1-1-1	7.284	NA	Director/D	
B.124	Border	CITY AMRITSAR	11KV	DS DIVN. INDUSTRIAL	ASR DS GOLDEN TEMPLE TECH., ASR	0754F06	LAXKAN MANDI	AMR	OK	31.03.2023	Category 1				4221025	1200/577/1-1-1	2.319	NA	Director/D	
B.125	Border	CITY AMRITSAR	11KV	DS DIVN. INDUSTRIAL	ASR DS GOLDEN TEMPLE TECH., ASR	0754F07	Baba Bhatta Temple	Not available	OK	31.03.2023	Category 1				1978947	1200/577/1-1-1	6.765	NA	Director/D	
B.126	Border	CITY AMRITSAR	66KV	DS DIVN. INDUSTRIAL	ASR DS GOLDEN TEMPLE TECH., ASR	0754D01	GIS GOLDEN TEMPLE	Not available	OK	31.03.2023	Category 1				Not available	Not available	7.548	NA	Director/D	
B.127	Border	CITY AMRITSAR	11KV	DS DIVN. INDUSTRIAL	ASR DS S/D CHATWIND TECH., ASR	C753F08	Laxmi Rice Mills	AMR	OK	31.03.2023	Category 2				2068348	1200/577/1-1-1	2.593	NA	Director/D	
B.128	Border	CITY AMRITSAR	11KV	DS DIVN. INDUSTRIAL	ASR DS S/D CHATWIND TECH., ASR	C753F03	Kot Babla Deep singh	AMR	OK	31.03.2023	Category 1				2068513	1200/577/1-1-1	3.579	NA	Director/D	
B.129	Border	CITY AMRITSAR	11KV	DS DIVN. INDUSTRIAL	ASR DS S/D CHATWIND TECH., ASR	C753F05	Mohan Rice Mills	AMR	OK	31.03.2023	Category 1				2068465	1200/577/1-1-1	6.040	NA	Director/D	
B.130	Border	CITY AMRITSAR</																		

S.No	Zone	Circle	Voltage Level (kVA)	Division (kVA)	Sub-Division (kVA)	Feeder ID	Feeder Name	Feeder Metering Status (Metred/unmetred/AMR/AM)	Status of Meter (Functional/Non-Functional)	Metering Date (Date of last actual meter working/communication)	Feeder Type (Agr/Industrial/Mixed)	Status of Communication			Period from 01.04.2021 to 31.03.2022				Sales	Remarks (Source of data)
												% data received through automatically if feeder AMR/AM	Number of hours when meter was unable to communicate in week	Total Number of hours in the period	Meter S.No	CT/PT ratio	Import (kWh)	Export (kWh)		
B.164	Border	GURDASPUR	11KV	DS CITY DIVN. BATALA	DS S/D PANI GRAIAN	B89FL05	SADARANG	AMR	OK	31.03.2023	AP 3Phase 3Wire				12093470	400-200/5-5	2,506	NA	Director/D	
B.165	Border	GURDASPUR	11KV	DS CITY DIVN. BATALA	DS S/D PANI GRAIAN	D085FL05	Choudharywal	AMR	OK	31.03.2023	AP 3Phase 3Wire				2066776	1200-600/5	1,924	NA	Director/D	
B.166	Border	GURDASPUR	11KV	DS CITY DIVN. BATALA	DS S/D PANI GRAIAN	D085FL02	Doulatpur	AMR	OK	31.03.2023	AP 3Phase 3Wire				9153995	1200-600/5	2,163	NA	Director/D	
B.167	Border	GURDASPUR	11KV	DS CITY DIVN. BATALA	DS S/D PANI GRAIAN	D085FL04	Shore	AMR	OK	31.03.2023	AP 3Phase 3Wire				1206335	400-200/5-5	2,385	NA	Director/D	
B.168	Border	GURDASPUR	11KV	DS CITY DIVN. BATALA	DS S/D PANI GRAIAN	D085FL10	Tara Chack	AMR	OK	31.03.2023	AP 3Phase 3Wire				7030228	900-450/577/1-1	2,528	NA	Director/D	
B.169	Border	GURDASPUR	11KV	DS CITY DIVN. BATALA	DS S/D PANI GRAIAN	D085FL09	Rasulpur	AMR	OK	31.03.2023	AP 3Phase 3Wire				5342492	1200-600/5	2,580	NA	Director/D	
B.170	Border	GURDASPUR	11KV	DS CITY DIVN. BATALA	DS S/D PANI GRAIAN	D085FL07	Dhadiala	AMR	OK	31.03.2023	AP 3Phase 3Wire				2068705	900-450/577/1-1	2,860	NA	Director/D	
B.171	Border	GURDASPUR	11KV	DS CITY DIVN. BATALA	DS S/D PANI GRAIAN	D085FL06	Threewall UPS Feeder	AMR	OK	31.03.2023	Category 5-UPS				9534446	1200-600/5	9,614	NA	Director/D	
B.172	Border	GURDASPUR	11KV	DS CITY DIVN. BATALA	DS S/D PANI GRAIAN	D085FL01	24 Hrs Supply	AMR	OK	31.03.2023	Category 1				5341632	1200-600/5	10,372	NA	Director/D	
B.173	Border	GURDASPUR	11KV	DS CITY DIVN. BATALA	DS S/D PANI GRAIAN	D085FL11	Kanama	NON AMR	OK	31.03.2023	Category 5-UPS				6486413	1200-600/5	11,085	NA	Director/D	
B.174	Border	GURDASPUR	11KV	DS CITY DIVN. BATALA	DS S/D SOUTH BATALA	D085FL16	Improvement Trust	NON AMR	OK	31.03.2023	Category 1				2067878	1200-600/5	1,155	NA	Director/D	
B.175	Border	GURDASPUR	11KV	DS CITY DIVN. BATALA	DS S/D SOUTH BATALA	D085FL14	KHAJURI GATE	NON AMR	OK	31.03.2023	Category 1				2067878	1200-600/5	5,554	NA	Director/D	
B.176	Border	GURDASPUR	11KV	DS CITY DIVN. BATALA	DS S/D SOUTH BATALA	D085FL07	Gurdwara Kandh Sahib	AMR	OK	31.03.2023	Category 1				20736641	1200-600/5	9,286	NA	Director/D	
B.177	Border	GURDASPUR	11KV	DS CITY DIVN. BATALA	DS S/D SOUTH BATALA	DTG4FL05	11 KV HOT LINE CIVIL HOSPITAL	AMR	OK	31.03.2023	Category 4				2654	1200/ 577/1-1-1	0,434	NA	Director/D	
B.178	Border	GURDASPUR	11KV	DS CITY DIVN. BATALA	DS S/D SOUTH BATALA	DTG4FL01	Diamond Colony	AMR	OK	31.03.2023	Category 1				3652	1200/ 577/1-1-1	9,413	NA	Director/D	
B.179	Border	GURDASPUR	11KV	DS CITY DIVN. BATALA	DS S/D SOUTH BATALA	DTG4FL02	Mata Sulakhni Ji	AMR	OK	31.03.2023	Category 1				2750	1200/ 577/1-1-1	11,040	NA	Director/D	
B.180	Border	GURDASPUR	11KV	DS CITY DIVN. BATALA	DS S/D UDHANWAL	B79FL03	11 KV Chone UPS	AMR	OK	31.03.2023	Category 5-UPS				120922474	400-200/5-5	0,819	NA	Director/D	
B.181	Border	GURDASPUR	11KV	DS CITY DIVN. BATALA	DS S/D UDHANWAL	B79FL07	Chhota enokot	AMR	OK	31.03.2023	AP 3Phase 3Wire				4198	400-200/5-5	1,291	NA	Director/D	
B.182	Border	GURDASPUR	11KV	DS CITY DIVN. BATALA	DS S/D UDHANWAL	B79FL01	11 KV Gande Ke Chone	AMR	OK	31.03.2023	AP 3Phase 3Wire				120924494	400-200/5-5	2,423	NA	Director/D	
B.183	Border	GURDASPUR	11KV	DS CITY DIVN. BATALA	DS S/D UDHANWAL	B79FL02	11 KV Kota Suba	NON AMR	OK	31.03.2023	AP 3Phase 3Wire				120924741	400-200/5-5	2,573	NA	Director/D	
B.184	Border	GURDASPUR	11KV	DS CITY DIVN. BATALA	DS S/D UDHANWAL	B79FL04	Paroshah	AMR	OK	31.03.2023	Category 5-UPS				7112100	400-200/5-5	6,423	NA	Director/D	
B.185	Border	GURDASPUR	11KV	DS CITY DIVN. BATALA	DS S/D UDHANWAL	D085FL08	Dhandhol	AMR	OK	31.03.2023	AP 3Phase 3Wire				5342480	900-450/577/1-1	2,142	NA	Director/D	
B.186	Border	GURDASPUR	11KV	DS CITY DIVN. BATALA	DS S/D UDHANWAL	D085FL12	11 KV MURADPUR AP	AMR	OK	31.03.2023	AP 3Phase 3Wire				1737	900-450/577/1-1	2,174	NA	Director/D	
B.187	Border	GURDASPUR	11KV	DS CITY DIVN. BATALA	DS S/D UDHANWAL	D085FL17	11KV DHANDE AP	AMR	OK	31.03.2023	AP 3Phase 3Wire				73163612	900-450/577/1-1	1,248	NA	Director/D	
B.188	Border	GURDASPUR	11KV	DS CITY DIVN. BATALA	DS S/D UDHANWAL	D085FL01	Bhoma Boje	AMR	OK	31.03.2023	AP 3Phase 3Wire				5342143	900-450/577/1-1	1,448	NA	Director/D	
B.189	Border	GURDASPUR	11KV	DS CITY DIVN. BATALA	DS S/D UDHANWAL	D085FL11	Shore	AMR	OK	31.03.2023	AP 3Phase 3Wire				6745330	900-450/577/1-1	1,671	NA	Director/D	
B.190	Border	GURDASPUR	11KV	DS CITY DIVN. BATALA	DS S/D UDHANWAL	D085FL16	11KV DHARAMKOT AP	AMR	OK	31.03.2023	AP 3Phase 3Wire				73163611	900-450/577/1-1	1,754	NA	Director/D	
B.191	Border	GURDASPUR	11KV	DS CITY DIVN. BATALA	DS S/D UDHANWAL	D085FL07	Innokot	AMR	OK	31.03.2023	AP 3Phase 3Wire				5342166	900-450/577/1-1	1,813	NA	Director/D	
B.192	Border	GURDASPUR	11KV	DS CITY DIVN. BATALA	DS S/D UDHANWAL	D085FL05	Harpura (B) Dhira	AMR	OK	31.03.2023	AP 3Phase 3Wire				395248	900-450/577/1-1	2,083	NA	Director/D	
B.193	Border	GURDASPUR	11KV	DS CITY DIVN. BATALA	DS S/D UDHANWAL	D085FL09	Madhre	AMR	OK	31.03.2023	AP 3Phase 3Wire				6740848	900-450/577/1-1	2,100	NA	Director/D	
B.194	Border	GURDASPUR	11KV	DS CITY DIVN. BATALA	DS S/D UDHANWAL	D085FL04	Kohali	AMR	OK	31.03.2023	AP 3Phase 3Wire				5437522	900-450/577/1-1	2,161	NA	Director/D	
B.195	Border	GURDASPUR	11KV	DS CITY DIVN. BATALA	DS S/D UDHANWAL	D085FL10	Harpura (A)	AMR	OK	31.03.2023	AP 3Phase 3Wire				4357949	900-450/577/1-1	2,235	NA	Director/D	
B.196	Border	GURDASPUR	11KV	DS CITY DIVN. BATALA	DS S/D UDHANWAL	D085FL06	Manesh (A)	AMR	OK	31.03.2023	AP 3Phase 3Wire				2067889	900-450/577/1-1	2,418	NA	Director/D	
B.197	Border	GURDASPUR	11KV	DS CITY DIVN. BATALA	DS S/D UDHANWAL	D085FL08	sakhowal	AMR	OK	31.03.2023	AP 3Phase 3Wire				2066261	900-450/577/1-1	2,929	NA	Director/D	
B.198	Border	GURDASPUR	11KV	DS CITY DIVN. BATALA	DS S/D UDHANWAL	D085FL14	Nati (mokal)	AMR	OK	31.03.2023	AP 3Phase 3Wire				5390810	900-450/577/1-1	3,021	NA	Director/D	
B.199	Border	GURDASPUR	11KV	DS CITY DIVN. BATALA	DS S/D UDHANWAL	D085FL03	Kandila	AMR	OK	31.03.2023	AP 3Phase 3Wire				2067400	900-450/577/1-1	3,240	NA	Director/D	
B.200	Border	GURDASPUR	11KV	DS CITY DIVN. BATALA	DS S/D UDHANWAL	D085FL17	Attepur	AMR	OK	31.03.2023	Category 5-UPS				20662751	900-450/577/1-1	9,116	NA	Director/D	
B.201	Border	GURDASPUR	11KV	DS CITY DIVN. BATALA	DS S/D UDHANWAL	D085FL02	Udhanwal	AMR	OK	31.03.2023	Category 5-UPS				9534480	900-450/577/1-1	5,346	NA	Director/D	
B.202	Border	GURDASPUR	11KV	DS CITY DIVN. BATALA	DS S/D UDHANWAL	D085FL15	KHUALA	AMR	OK	31.03.2023	Category 5-UPS				6740914	900-450/577/1-1	5,378	NA	Director/D	
B.203	Border	GURDASPUR	11KV	DS CITY DIVN. BATALA	DS S/D UDHANWAL	D085FL18	11 K.V. BOPARAI (UPS)	AMR	OK	31.03.2023	Category 5-UPS				4583	900-450/577/1-1	5,624	NA	Director/D	
B.204	Border	GURDASPUR	11KV	DS CITY DIVN. BATALA	DS S/D WEST S/D BATALA	C85FL03	Achal Sahib	AMR	OK	31.03.2023	AP 3Phase 3Wire				2994129	900-450/577/1-1	1,362	NA	Director/D	
B.205	Border	GURDASPUR	11KV	DS CITY DIVN. BATALA	DS S/D WEST S/D BATALA	B85FL09	220 LT S/S Wadala Grantham	AMR	OK	31.03.2023	Category 1				1447	900-450/577/1-1	0,001	NA	Director/D	
B.206	Border	GURDASPUR	11KV	DS CITY DIVN. BATALA	DS S/D WEST S/D BATALA	B85FL10	mansha	AMR	OK	31.03.2023	AP 3Phase 3Wire				2069203	400-200/5-5	1,900	NA	Director/D	
B.207	Border	GURDASPUR	11KV	DS CITY DIVN. BATALA	DS S/D WEST S/D BATALA	B85FL03	Grantgarh	AMR	OK	31.03.2023	AP 3Phase 3Wire				5614	900-450/577/1-1	2,574	NA	Director/D	
B.208	Border	GURDASPUR	11KV	DS CITY DIVN. BATALA	DS S/D WEST S/D BATALA	B85FL02	Fly Sahib	AMR	OK	31.03.2023	AP 3Phase 3Wire				5612	400-200/5-5	2,622	NA	Director/D	
B.209	Border	GURDASPUR	11KV	DS CITY DIVN. BATALA	DS S/D WEST S/D BATALA	B85FL11	11 KV Massanian	AMR	OK	31.03.2023	Category 5-UPS				4754	400-200/5-5	3,098	NA	Director/D	
B.210	Border	GURDASPUR	11KV	DS CITY DIVN. BATALA	DS S/D WEST S/D BATALA	B85FL01	WGrantham 24 Hrs	AMR	OK	31.03.2023	Category 1				11069761	900-450/577/1-1	3,384	NA	Director/D	
B.211	Border	GURDASPUR	11KV	DS CITY DIVN. BATALA	DS S/D WEST S/D BATALA	D085FL05	Wardha UPS	NON AMR	OK	31.03.2023	Category 5-UPS				9534480	900-450/577/1-1	9,116	NA	Director/D	
B.212	Border	GURDASPUR	11KV	DS CITY DIVN. BATALA	DS S/D WEST S/D BATALA	D085FL10	Gurdwara Achal Sahib	NON AMR	OK	31.03.2023	Category 1				910261	900-450/577/1-1	0,210	NA	Director/D	
B.213	Border	GURDASPUR	11KV	DS CITY DIVN. BATALA	DS S/D WEST S/D BATALA	D085FL06	Malave de Kothi	AMR	OK	31.03.2023	Category 1				2994126	200-100/5-5	0,399	NA	Director/D	
B.214	Border	GURDASPUR	11KV	DS CITY DIVN. BATALA	DS S/D WEST S/D BATALA	D085FL01	Salio	AMR	OK	31.03.2023	AP 3Phase 3Wire				2066798	200-100/5-5	0,938	NA	Director/D	
B.215	Border	GURDASPUR	11KV	DS CITY DIVN. BATALA	DS S/D WEST S/D BATALA	D085FL02	Partagarh	AMR	OK	31.03.2023	AP 3Phase 3Wire				5295680	200-100/5-5	1,106	NA	Director/D	
B.216	Border	GURDASPUR	11KV	DS CITY DIVN. BATALA	DS S/D WEST S/D BATALA	D085FL08	Misharpura	AMR	OK	31.03.2023	AP 3Phase 3Wire				8222412	900-450/577/1-1	1,628	NA	Director/D	
B.217	Border	GURDASPUR	11KV	DS CITY DIVN. BATALA	DS S/D WEST S/D BATALA	D085FL03	Nati	AMR	OK	31.03.2023	AP 3Phase 3Wire				2067203	200-100/5-5	1,695	NA	Director/D	
B.218	Border	GURDASPUR	11KV	DS CITY DIVN. BATALA	DS S/D WEST S/D BATALA	D085FL07	Basarpura	AMR	OK	31.03.2023	AP 3Phase 3Wire				8223422	900-450/577/1-1	1,976	NA	Director/D	
B.219	Border	GURDASPUR	11KV	DS CITY DIVN. BATALA	DS S/D WEST S/D BATALA	D085FL09	Baali Inderjit	AMR	OK	31.03.2023	Category 1				910261	900-450/577/1-1	3,131	NA	Director/D	
B.220	Border	GURDASPUR	11KV	DS CITY DIVN. BATALA	DS S/D WEST S/D BATALA	D085FL11	11kv UPS Khoje wal	NON AMR	OK	31.03.2023	Category 5-UPS				120485	900-450/577/1-1	6,334	NA	Director/D	
B.221	Border	GURDASPUR	11KV	DS CITY DIVN. BATALA	DS S/D WEST S/D BATALA	D085FL04	24 hrs chahal kalan	AMR	OK	31.03.2023	Category 5-UPS				2067975	200-100/5-5	9,342	NA	Director/D	
B.222	Border	GURDASPUR	11KV	DS CITY DIVN. BATALA	DS S/D WEST S/D BATALA	DTG4FL07	11 kv Dhuasahar upu	AMR	OK	31.03.2023	Category 5-UPS				5342167	900-450/577/1-1	9,166	NA	Director/D	
B.223	Border	GURDASPUR	11KV	DS CITY DIVN. BATALA	DS S/D WEST S/D BATALA	DTG4FL04	Jiggar Nagar	AMR	OK	31.03.2023	Category 1				2628	1200/ 577/1-1-1	8,855	NA	Director/D	
B.224	Border	GURDASPUR	11KV	DS CITY DIVN. BATALA	DS S/D WEST S/D BATALA	DTG4FL06	11 KV Guru Nanak College	AMR	OK	31.03.2023	Category 1				4952	1200/ 577/1-1-1	9,161	NA	Director/D	
B.225	Border	GURDASPUR	11KV	DS CITY DIVN. BATALA	DS S/D WEST S/D BATALA	DTG4FL03	South City	AMR	OK	31.03.2023	Category 1				2648	1200/ 577/1-1-1	10,555	NA	Director/D	
B.226	Border	GURDASPUR	11KV	DS CITY DIVN. BATALA	DS S/D WEST S/D BATALA	D085FL03	Behardur Hussain	AMR	OK	31.03.2023	AP 3Phase 3Wire				2067129	1200-600/5	2,412	NA	Director/D	
B.227	Border	GURDASPUR	11KV	DS CITY DIVN. BATALA	DS S/D WEST S/D BATALA	D085FL08	11 KV Rangar Nangal (AP)	AMR	OK	31.03.2023	AP 3Phase 3Wire				2066293	900-450/577/1-1	1,283	NA	Director/D	
B.228</																				

S.No	Zone	Circle	Voltage Level (kVA)	Division (kVA)	Sub-Division (kVA)	Feeder ID	Feeder Name	Feeder Metering Status (Metered/unmetered/AMR/AMI)	Status of Meter (Functional/Non-functional)	Metering Date (Date of last actual meter reading/communication)	Feeder Type (Agr./Industrial/Mixed)	Status of Communication			Period from 01.04.2021 to 31.03.2022				Sales	Remarks (Source of data)
												% data received through automatically if feeder AMR/AMI	Number of hours when meter was unable to communicate in overall	Total Number of hours in the period	Meter S.No	CT/PT ratio	Import (kU)	Export (kU)		
B.261	Border	GURDASPUR	11KV	DS CITY DIVN. PATHANKOT	DS S/D N.JAIMAL SINGH	0877F08	Banial 24hrs	AMR	OK	31.03.2023	Category 5-UPS				10288375	900-450/577/1-1-1	9.771	NA	Director/D	
B.262	Border	GURDASPUR	11KV	DS CITY DIVN. PATHANKOT	DS S/D NORTH PATHANKOT	C858F21	Railway Road	NON AMR	OK	31.03.2023	Category 1				2067408	1200-600/5	12.035	NA	Director/D	
B.263	Border	GURDASPUR	11KV	DS CITY DIVN. PATHANKOT	DS S/D NORTH PATHANKOT	C858F12	Gurdaspur Road	AMR	OK	31.03.2023	Category 1				2067012	1200-600/5	12.852	NA	Director/D	
B.264	Border	GURDASPUR	11KV	DS CITY DIVN. PATHANKOT	DS S/D NORTH PATHANKOT	C858F10	Abad Nagar	NON AMR	OK	31.03.2023	Category 1				7310490	1200-600/5	5.874	NA	Director/D	
B.265	Border	GURDASPUR	11KV	DS CITY DIVN. PATHANKOT	DS S/D NORTH PATHANKOT	C858F03	Anandpur Road	AMR	OK	31.03.2023	Category 1				2067633	1200-600/5	11.035	NA	Director/D	
B.266	Border	GURDASPUR	11KV	DS CITY DIVN. PATHANKOT	DS S/D SARNA	C858F19	JIBDC	NON AMR	OK	31.03.2023	Category 4				2061441	1200-600/5	0.000	NA	Director/D	
B.267	Border	GURDASPUR	11KV	DS CITY DIVN. PATHANKOT	DS S/D SARNA	C858F09	Naushera Nal Banda	NON AMR	OK	31.03.2023	Category 2				2066977	1200-600/5	2.420	NA	Director/D	
B.268	Border	GURDASPUR	11KV	DS CITY DIVN. PATHANKOT	DS S/D SARNA	C857F16	Plast Workshop	NON AMR	OK	31.03.2023	Category 1				6677975	1200-600/5	0.053	NA	Director/D	
B.269	Border	GURDASPUR	11KV	DS CITY DIVN. PATHANKOT	DS S/D SARNA	C857F10	Power House No-3	NON AMR	OK	31.03.2023	Category 4				6740749	1200-600/5	0.171	NA	Director/D	
B.270	Border	GURDASPUR	11KV	DS CITY DIVN. PATHANKOT	DS S/D SARNA	C857F08	220KV Grid	NON AMR	OK	31.03.2023	Category 4				6740762	1200-600/5	0.195	NA	Director/D	
B.271	Border	GURDASPUR	11KV	DS CITY DIVN. PATHANKOT	DS S/D SARNA	C857F17	Power House 1&2	NON AMR	OK	31.03.2023	Category 4				6740771	1200-600/5	0.366	NA	Director/D	
B.272	Border	GURDASPUR	11KV	DS CITY DIVN. PATHANKOT	DS S/D SARNA	C857F01	Malkpur Colony	NON AMR	OK	31.03.2023	Category 4				2994133	1200-600/5	0.440	NA	Director/D	
B.273	Border	GURDASPUR	11KV	DS CITY DIVN. PATHANKOT	DS S/D SARNA	C857F03	Sarna	AMR	OK	31.03.2023	Category 1				2067731	1200-600/5	0.510	NA	Director/D	
B.274	Border	GURDASPUR	11KV	DS CITY DIVN. PATHANKOT	DS S/D SARNA	C857F04	Kiran	AMR	OK	31.03.2023	AP 3Phase 3Wire				6607231	1200-600/5	0.577	NA	Director/D	
B.275	Border	GURDASPUR	11KV	DS CITY DIVN. PATHANKOT	DS S/D SARNA	C857F11	BHOA	AMR	OK	31.03.2023	AP 3Phase 3Wire				8223637	1200-600/5	0.647	NA	Director/D	
B.276	Border	GURDASPUR	11KV	DS CITY DIVN. PATHANKOT	DS S/D SARNA	C857F05	Koili	AMR	OK	31.03.2023	AP 3Phase 3Wire				8123424	1200-600/5	0.845	NA	Director/D	
B.277	Border	GURDASPUR	11KV	DS CITY DIVN. PATHANKOT	DS S/D SARNA	C857F18	Court Complex	NON AMR	OK	31.03.2023	Category 2				13190531	1200-600/5	1.402	NA	Director/D	
B.278	Border	GURDASPUR	11KV	DS CITY DIVN. PATHANKOT	DS S/D SARNA	C857F06	Jagat Floor Mill	NON AMR	OK	31.03.2023	Category 2				6740755	1200-600/5	3.093	NA	Director/D	
B.279	Border	GURDASPUR	11KV	DS CITY DIVN. PATHANKOT	DS S/D SARNA	C857F07	Azipur Sarna	NON AMR	OK	31.03.2023	Kandi Mixed				6740786	1200-600/5	7.492	NA	Director/D	
B.280	Border	GURDASPUR	11KV	DS CITY DIVN. PATHANKOT	DS S/D SARNA	C857F15	Bhaginsapur	NON AMR	OK	31.03.2023	Category 5-UPS				9534414	1200-600/5	9.151	NA	Director/D	
B.281	Border	GURDASPUR	11KV	DS CITY DIVN. PATHANKOT	DS S/D SARNA	C857F13	Nand Metra	NON AMR	OK	31.03.2023	Category 5-UPS				5452634	1200-600/5	9.637	NA	Director/D	
B.282	Border	GURDASPUR	11KV	DS CITY DIVN. PATHANKOT	DS S/D SARNA	C857F14	Maira UPS	NON AMR	OK	31.03.2023	Category 5-UPS				5295574	1200-600/5	10.144	NA	Director/D	
B.283	Border	GURDASPUR	11KV	DS CITY DIVN. PATHANKOT	DS S/D SARNA	C857F14	Bharoli	AMR	OK	31.03.2023	Category 1				2066350	1200-600/5	10.847	NA	Director/D	
B.284	Border	GURDASPUR	11KV	DS CITY DIVN. PATHANKOT	DS S/D SARNA	0709F03	Mangal	AMR	OK	31.03.2023	AP 3Phase 3Wire				5258	900-450/577/1-1-1	0.086	NA	Director/D	
B.285	Border	GURDASPUR	11KV	DS CITY DIVN. PATHANKOT	DS S/D SARNA	0709F01	Bani Lodhi	AMR	OK	31.03.2023	Category 1				5417	900-450/577/1-1-1	2.615	NA	Director/D	
B.286	Border	GURDASPUR	11KV	DS CITY DIVN. PATHANKOT	DS S/D SARNA	0709F02	Chifera 2	AMR	OK	31.03.2023	Category 5-UPS				5387	900-450/577/1-1-1	7.330	NA	Director/D	
B.287	Border	GURDASPUR	11KV	DS CITY DIVN. PATHANKOT	DS S/D SARNA	0G19F05	Civil Airport	AMR	OK	31.03.2023	Category 4				593620	1200/577/1-1-1	0.258	NA	Director/D	
B.288	Border	GURDASPUR	11KV	DS CITY DIVN. PATHANKOT	DS S/D SARNA	0G19F02	Dherial	AMR	OK	31.03.2023	Kandi Mixed				583701	1200/577/1-1-1	1.011	NA	Director/D	
B.289	Border	GURDASPUR	11KV	DS CITY DIVN. PATHANKOT	DS S/D SARNA	0G19F06	Najo Chack	AMR	OK	31.03.2023	Kandi Mixed				583746	1200/577/1-1-1	1.416	NA	Director/D	
B.290	Border	GURDASPUR	11KV	DS CITY DIVN. PATHANKOT	DS S/D SARNA	0G19F03	Dhaki	AMR	OK	31.03.2023	Category 1				583745	1200/577/1-1-1	5.123	NA	Director/D	
B.291	Border	GURDASPUR	11KV	DS CITY DIVN. PATHANKOT	DS S/D SARNA	0G19F01	N.N.Bandha	AMR	OK	31.03.2023	Kandi Mixed				583742	1200/577/1-1-1	9.049	NA	Director/D	
B.292	Border	GURDASPUR	11KV	DS CITY DIVN. PATHANKOT	DS S/D SARNA	0782F06	Faride Nagar	AMR	OK	31.03.2023	Category 5-UPS				4301	900-450/577/1-1-1	2.369	NA	Director/D	
B.293	Border	GURDASPUR	11KV	DS CITY DIVN. PATHANKOT	DS S/D SARNA	0782F05	Balsua	AMR	OK	31.03.2023	AP 3Phase 3Wire				4356	900-450/577/1-1-1	0.285	NA	Director/D	
B.294	Border	GURDASPUR	11KV	DS CITY DIVN. PATHANKOT	DS S/D SARNA	0782F02	GOBINDSAR	AMR	OK	31.03.2023	Category 5-UPS				10282790	900-450/577/1-1-1	2.133	NA	Director/D	
B.295	Border	GURDASPUR	11KV	DS CITY DIVN. PATHANKOT	DS S/D SARNA	0782F04	Rasphaina	AMR	OK	31.03.2023	Category 5-UPS				16192533	900-450/577/1-1-1	6.081	NA	Director/D	
B.296	Border	GURDASPUR	11KV	DS CITY DIVN. PATHANKOT	DS S/D SARNA	0782F01	Koili Mughlan	AMR	OK	31.03.2023	Category 1				10282786	900-450/577/1-1-1	6.187	NA	Director/D	
B.297	Border	GURDASPUR	11KV	DS CITY DIVN. PATHANKOT	DS S/D SARNA	0782F03	BhARAL LAHR	AMR	OK	31.03.2023	Category 5-UPS				1028267	900-450/577/1-1-1	9.086	NA	Director/D	
B.298	Border	GURDASPUR	11KV	DS CITY DIVN. PATHANKOT	DS S/D SARNA	0877F12	Jawan	AMR	OK	31.03.2023	Category 5-UPS				33427	900-450/577/1-1-1	7.235	NA	Director/D	
B.299	Border	GURDASPUR	11KV	DS CITY DIVN. PATHANKOT	DS S/D SARNA	0887F06	Chhauran	AMR	OK	31.03.2023	Category 5-UPS				4385	900-450/577/1-1-1	2.237	NA	Director/D	
B.300	Border	GURDASPUR	11KV	DS CITY DIVN. PATHANKOT	DS S/D SOUTH PATHANKOT	0882F19	Air Force	NON AMR	OK	31.03.2023	Category 4				2066855	1200-600/5	0.000	NA	Director/D	
B.301	Border	GURDASPUR	11KV	DS CITY DIVN. PATHANKOT	DS S/D SOUTH PATHANKOT	C858F02	Danttal	NON AMR	OK	31.03.2023	Category 1				2607031	1200-600/5	3.352	NA	Director/D	
B.302	Border	GURDASPUR	11KV	DS CITY DIVN. PATHANKOT	DS S/D SOUTH PATHANKOT	C858F13	Military Hospital	AMR	OK	31.03.2023	Category 4				2067408	1200-600/5	3.785	NA	Director/D	
B.303	Border	GURDASPUR	11KV	DS CITY DIVN. PATHANKOT	DS S/D SOUTH PATHANKOT	C858F07	Prom Nagar	AMR	OK	31.03.2023	Category 1				2067441	1200-600/5	3.379	NA	Director/D	
B.304	Border	GURDASPUR	11KV	DS CITY DIVN. PATHANKOT	DS S/D SOUTH PATHANKOT	C858F08	Gandhi Chowk	NON AMR	OK	31.03.2023	Category 1				2066688	900-450/577/1-1-1	8.521	NA	Director/D	
B.305	Border	GURDASPUR	11KV	DS CITY DIVN. PATHANKOT	DS S/D SOUTH PATHANKOT	C858F11	Burma Shell	NON AMR	OK	31.03.2023	Category 1				2066602	1200-600/5	9.205	NA	Director/D	
B.306	Border	GURDASPUR	11KV	DS CITY DIVN. PATHANKOT	DS S/D SOUTH PATHANKOT	C858F01	Model Town	AMR	OK	31.03.2023	Category 1				2067443	1200-600/5	14.597	NA	Director/D	
B.307	Border	GURDASPUR	11KV	DS CITY DIVN. PATHANKOT	DS S/D SOUTH PATHANKOT	C858F10	Sunder Nagar	AMR	OK	31.03.2023	Category 1				2064444	1200-600/5	16.379	NA	Director/D	
B.308	Border	GURDASPUR	66KV	DS CITY DIVN. PATHANKOT	DS S/D SOUTH PATHANKOT	0882F04	Badgump	Not available	OK	31.03.2023	Category 4				956967	900-450/577/1-1-1	0.060	NA	Director/D	
B.309	Border	GURDASPUR	66KV	DS CITY DIVN. PATHANKOT	DS S/D SOUTH PATHANKOT	0882F13	Air Force 2	NON AMR	OK	31.03.2023	Category 1				Not available	Not available	9.956	NA	Director/D	
B.310	Border	GURDASPUR	11KV	DS CITY DIVN. PATHANKOT	DS S/D SUJANPUR	C857F02	JIBDC-2	NON AMR	OK	31.03.2023	Category 4				206732	1200-600/5	0.115	NA	Director/D	
B.311	Border	GURDASPUR	11KV	DS CITY DIVN. PATHANKOT	DS S/D SUJANPUR	0876F05	Irrigation	AMR	OK	31.03.2023	Category 4				2068186	900-450/577/1-1-1	0.052	NA	Director/D	
B.312	Border	GURDASPUR	11KV	DS CITY DIVN. PATHANKOT	DS S/D SUJANPUR	0876F14	Raavi	NON AMR	OK	31.03.2023	Category 1				73142331	900-450/577/1-1-1	2.213	NA	Director/D	
B.313	Border	GURDASPUR	11KV	DS CITY DIVN. PATHANKOT	DS S/D SUJANPUR	0876F01	MES Madhopur	NON AMR	OK	31.03.2023	Category 4				2068118	900-450/577/1-1-1	2.385	NA	Director/D	
B.314	Border	GURDASPUR	11KV	DS CITY DIVN. PATHANKOT	DS S/D SUJANPUR	0876F10	Pratap Agro	AMR	OK	31.03.2023	Category 1				2068181	900-450/577/1-1-1	2.687	NA	Director/D	
B.315	Border	GURDASPUR	11KV	DS CITY DIVN. PATHANKOT	DS S/D SUJANPUR	0876F17	Isampur No. 1	AMR	OK	31.03.2023	Category 1				4124	900-450/577/1-1-1	3.281	NA	Director/D	
B.316	Border	GURDASPUR	11KV	DS CITY DIVN. PATHANKOT	DS S/D SUJANPUR	0876F12	11kv arankari	NON AMR	OK	31.03.2023	Category 1				4088	900-450/577/1-1-1	4.063	NA	Director/D	
B.317	Border	GURDASPUR	11KV	DS CITY DIVN. PATHANKOT	DS S/D SUJANPUR	0876F11	Madhopur	NON AMR	OK	31.03.2023	Kandi Mixed				206418	900-450/577/1-1-1	4.394	NA	Director/D	
B.318	Border	GURDASPUR	11KV	DS CITY DIVN. PATHANKOT	DS S/D SUJANPUR	0876F08	GHO	NON AMR	OK	31.03.2023	Kandi Mixed				488	900-450/577/1-1-1	4.650	NA	Director/D	
B.319	Border	GURDASPUR	11KV	DS CITY DIVN. PATHANKOT	DS S/D SUJANPUR	0876F13	Bhambri	AMR	OK	31.03.2023	AP 3Phase 3Wire				31678	900-				

S.No	Zone	Circle	Voltage Level (kVA)	Division (kVA)	Sub-Division (kVA)	Feeder ID	Feeder Name	Feeder Metering Status (Metered/unmetered/AM/AMR)	Status of Meter (Functional/Non-Functional)	Metering Date (Date of last actual meter reading/communication)	Feeder Type (Agr/Industrial/Mixed)	Status of Communication			Period from 01.04.2021 to 31.03.2022				Sales	Remarks (Source of data)
												% Data received through automatically by feeder AMR/AMI	Number of hours when meter was unable to communicate in overall	Total Number of hours in the period	Meter S.No	CT/PT ratio	Import (kWh)	Export (kWh)		
B.358	Border	GURDASPUR	11kV	DS DIVN. QADIAN	DS S/D HARCHOWAL	0862FL02	11kV Beri	NON AMR	OK	31.03.2023	AP 3Phase 3Wire				23656	900-450/577/1-1-1	3.596	NA	Director/D	
B.359	Border	GURDASPUR	11kV	DS DIVN. QADIAN	DS S/D HARCHOWAL	0862FL15	DHINDSA	AMR	OK	31.03.2023	Category 5-UPS				23684	900-450/577/1-1-1	5.883	NA	Director/D	
B.360	Border	GURDASPUR	11kV	DS DIVN. QADIAN	DS S/D HARCHOWAL	0862FL10	College	AMR	OK	31.03.2023	Category 5-UPS				2067092	900-450/577/1-1-1	10.080	NA	Director/D	
B.361	Border	GURDASPUR	11kV	DS DIVN. QADIAN	DS S/D HARCHOWAL	0862FL11	Thakyalwar	AMR	OK	31.03.2023	Category 5-UPS				6483796	900-450/577/1-1-1	12.756	NA	Director/D	
B.362	Border	GURDASPUR	11kV	DS DIVN. QADIAN	DS S/D KANHUWAN	0854FL02	Bakhatpur	NON AMR	OK	31.03.2023	AP 3Phase 3Wire				8222386	1200-600/5	2.714	NA	Director/D	
B.363	Border	GURDASPUR	11kV	DS DIVN. QADIAN	DS S/D KANHUWAN	0871FL11	Sidhwan 24 hrs.	AMR	OK	31.03.2023	Category 5-UPS				6669378	1200-600/5	3.777	NA	Director/D	
B.364	Border	GURDASPUR	11kV	DS DIVN. QADIAN	DS S/D KANHUWAN	0865FL01	Jinder	AMR	OK	31.03.2023	AP 3Phase 3Wire				6607245	1200/577/1-1-1	1.419	NA	Director/D	
B.365	Border	GURDASPUR	11kV	DS DIVN. QADIAN	DS S/D KANHUWAN	0865FL06	Fula	NON AMR	OK	31.03.2023	AP 3Phase 3Wire				5437731	1200/577/1-1-1	1.653	NA	Director/D	
B.366	Border	GURDASPUR	11kV	DS DIVN. QADIAN	DS S/D KANHUWAN	0865FL04	Handa Lubana	AMR	OK	31.03.2023	AP 3Phase 3Wire				2094131	1200/577/1-1-1	1.866	NA	Director/D	
B.367	Border	GURDASPUR	11kV	DS DIVN. QADIAN	DS S/D KANHUWAN	0865FL07	Mulawal	AMR	OK	31.03.2023	AP 3Phase 3Wire				6579933	1200/577/1-1-1	1.584	NA	Director/D	
B.368	Border	GURDASPUR	11kV	DS DIVN. QADIAN	DS S/D KANHUWAN	0865FL05	Shaheed Rambir Singh	NON AMR	OK	31.03.2023	AP 3Phase 3Wire				4180049	1200/577/1-1-1	2.608	NA	Director/D	
B.369	Border	GURDASPUR	11kV	DS DIVN. QADIAN	DS S/D KANHUWAN	0865FL02	Bhaini Mian Khan	AMR	OK	31.03.2023	Category 1				2067886	1200/577/1-1-1	3.046	NA	Director/D	
B.370	Border	GURDASPUR	11kV	DS DIVN. QADIAN	DS S/D KANHUWAN	0865FL08	Gorsiya	NON AMR	OK	31.03.2023	Category 5-UPS				12527315	1200/577/1-1-1	6.205	NA	Director/D	
B.371	Border	GURDASPUR	11kV	DS DIVN. QADIAN	DS S/D KANHUWAN	0865FL03	UPS Feeder	AMR	OK	31.03.2023	Category 5-UPS				2067660	1200/577/1-1-1	8.377	NA	Director/D	
B.372	Border	GURDASPUR	11kV	DS DIVN. QADIAN	DS S/D KANHUWAN	0864FL23	11kV SIMBILI	AMR	OK	31.03.2023	AP 3Phase 3Wire				4693	900-450/577/1-1-1	0.375	NA	Director/D	
B.373	Border	GURDASPUR	11kV	DS DIVN. QADIAN	DS S/D KANHUWAN	0864FL07	Ghalughara	AMR	OK	31.03.2023	AP 3Phase 3Wire				2066735	900-450/577/1-1-1	0.866	NA	Director/D	
B.374	Border	GURDASPUR	11kV	DS DIVN. QADIAN	DS S/D KANHUWAN	0864FL03	Salopur	AMR	OK	31.03.2023	AP 3Phase 3Wire				2067313	900-450/577/1-1-1	1.017	NA	Director/D	
B.375	Border	GURDASPUR	11kV	DS DIVN. QADIAN	DS S/D KANHUWAN	0864FL04	Darapur	AMR	OK	31.03.2023	AP 3Phase 3Wire				11052014	900-450/577/1-1-1	1.159	NA	Director/D	
B.376	Border	GURDASPUR	11kV	DS DIVN. QADIAN	DS S/D KANHUWAN	0864FL05	Mallian	AMR	OK	31.03.2023	AP 3Phase 3Wire				6745318	900-450/577/1-1-1	1.638	NA	Director/D	
B.377	Border	GURDASPUR	11kV	DS DIVN. QADIAN	DS S/D KANHUWAN	0864FL13	Dulaura	AMR	OK	31.03.2023	AP 3Phase 3Wire				3115	900-450/577/1-1-1	1.097	NA	Director/D	
B.378	Border	GURDASPUR	11kV	DS DIVN. QADIAN	DS S/D KANHUWAN	0864FL02	Sidhwan	AMR	OK	31.03.2023	AP 3Phase 3Wire				9154248	900-450/577/1-1-1	2.332	NA	Director/D	
B.379	Border	GURDASPUR	11kV	DS DIVN. QADIAN	DS S/D KANHUWAN	0864FL06	Warach	AMR	OK	31.03.2023	AP 3Phase 3Wire				2066834	900-450/577/1-1-1	2.615	NA	Director/D	
B.380	Border	GURDASPUR	11kV	DS DIVN. QADIAN	DS S/D KANHUWAN	0864FL01	Sathali	NON AMR	OK	31.03.2023	AP 3Phase 3Wire				9334492	900-450/577/1-1-1	2.675	NA	Director/D	
B.381	Border	GURDASPUR	11kV	DS DIVN. QADIAN	DS S/D KANHUWAN	0864FL10	Roranwali 24 hrs.	NON AMR	OK	31.03.2023	Category 5-UPS				6669378	900-450/577/1-1-1	3.478	NA	Director/D	
B.382	Border	GURDASPUR	11kV	DS DIVN. QADIAN	DS S/D KANHUWAN	0864FL09	Sathali 24 hrs.	NON AMR	OK	31.03.2023	Category 5-UPS				11052042	900-450/577/1-1-1	5.283	NA	Director/D	
B.383	Border	GURDASPUR	11kV	DS DIVN. QADIAN	DS S/D KANHUWAN	0864FL01	Barawan City	NON AMR	OK	31.03.2023	Category 5-UPS				9334492	900-450/577/1-1-1	8.588	NA	Director/D	
B.384	Border	GURDASPUR	11kV	DS DIVN. QADIAN	DS S/D KANHUWAN	0864FL11	11 K.V UPS Balwanda	AMR	OK	31.03.2023	Category 5-UPS				11052037	900-450/577/1-1-1	8.893	NA	Director/D	
B.385	Border	GURDASPUR	11kV	DS DIVN. QADIAN	DS S/D QADIAN	0863FL12	Leel Kals	AMR	OK	31.03.2023	AP 3Phase 3Wire				2994121	100/5	1.877	NA	Director/D	
B.386	Border	GURDASPUR	11kV	DS DIVN. QADIAN	DS S/D QADIAN	0863FL02	Pandori	AMR	OK	31.03.2023	AP 3Phase 3Wire				9154340	100/5	2.099	NA	Director/D	
B.387	Border	GURDASPUR	11kV	DS DIVN. QADIAN	DS S/D QADIAN	0863FL10	Dhapal	AMR	OK	31.03.2023	AP 3Phase 3Wire				2068776	100/5	2.258	NA	Director/D	
B.388	Border	GURDASPUR	11kV	DS DIVN. QADIAN	DS S/D QADIAN	0863FL11	Thind Dharwal	AMR	OK	31.03.2023	AP 3Phase 3Wire				2068824	100/5	2.275	NA	Director/D	
B.389	Border	GURDASPUR	11kV	DS DIVN. QADIAN	DS S/D QADIAN	0863FL01	Barawan	AMR	OK	31.03.2023	AP 3Phase 3Wire				2067593	100/5	2.725	NA	Director/D	
B.390	Border	GURDASPUR	11kV	DS DIVN. QADIAN	DS S/D QADIAN	0863FL13	Dalia	AMR	OK	31.03.2023	AP 3Phase 3Wire				9154491	100/5	2.784	NA	Director/D	
B.391	Border	GURDASPUR	11kV	DS DIVN. QADIAN	DS S/D QADIAN	0863FL07	Butter	AMR	OK	31.03.2023	AP 3Phase 3Wire				2065862	100/5	3.062	NA	Director/D	
B.392	Border	GURDASPUR	11kV	DS DIVN. QADIAN	DS S/D QADIAN	0863FL04	Kot Todermal	AMR	OK	31.03.2023	AP 3Phase 3Wire				9154203	100/5	3.540	NA	Director/D	
B.393	Border	GURDASPUR	11kV	DS DIVN. QADIAN	DS S/D QADIAN	0863FL06	Dalia UPS	AMR	OK	31.03.2023	Category 5-UPS				5341552	100/5	5.359	NA	Director/D	
B.394	Border	GURDASPUR	11kV	DS DIVN. QADIAN	DS S/D QADIAN	0863FL16	11kV BUTTER UPS	NON AMR	OK	31.03.2023	Category 5-UPS				11052037	100/5	5.865	NA	Director/D	
B.395	Border	GURDASPUR	11kV	DS DIVN. QADIAN	DS S/D QADIAN	0863FL09	THEKERIWAL	AMR	OK	31.03.2023	Category 5-UPS				11116910	100/5	6.812	NA	Director/D	
B.396	Border	GURDASPUR	11kV	DS DIVN. QADIAN	DS S/D QADIAN	0863FL14	Barawan	AMR	OK	31.03.2023	Category 5-UPS				3215	100/5	6.905	NA	Director/D	
B.397	Border	GURDASPUR	11kV	DS DIVN. QADIAN	DS S/D QADIAN	0863FL15	L.T.I	AMR	OK	31.03.2023	Category 1				12527294	100/5	8.387	NA	Director/D	
B.398	Border	GURDASPUR	11kV	DS DIVN. QADIAN	DS S/D QADIAN	0863FL08	Civil Line	NON AMR	OK	31.03.2023	Category 1				116791	100/5	12.267	NA	Director/D	
B.399	Border	GURDASPUR	11kV	DS DIVN. QADIAN	DS S/D QADIAN	0863FL05	City	AMR	OK	31.03.2023	Category 1				9154461	100/5	14.392	NA	Director/D	
B.400	Border	GURDASPUR	11kV	DS DIVN. QADIAN	DS S/D QADIAN	0863FL13	Butter	AMR	OK	31.03.2023	AP 3Phase 3Wire				93345517	900-450/577/1-1-1	1.759	NA	Director/D	
B.401	Border	GURDASPUR	11kV	DS DIVN. QADIAN	DS S/D SRI HARGOBIINDPUR	CS45FL13	NANGAL JHOUR	AMR	OK	31.03.2023	AP 3Phase 3Wire				38626	1200/577/1-1-1	1.516	NA	Director/D	
B.402	Border	GURDASPUR	11kV	DS DIVN. QADIAN	DS S/D SRI HARGOBIINDPUR	CS45FL01	Bate	AMR	OK	31.03.2023	AP 3Phase 3Wire				5388162	1200-600/5	1.717	NA	Director/D	
B.403	Border	GURDASPUR	11kV	DS DIVN. QADIAN	DS S/D SRI HARGOBIINDPUR	CS45FL15	sokala	AMR	OK	31.03.2023	AP 3Phase 3Wire				4680	1200/577/1-1-1	2.198	NA	Director/D	
B.404	Border	GURDASPUR	11kV	DS DIVN. QADIAN	DS S/D SRI HARGOBIINDPUR	CS45FL10	Sarnvir	AMR	OK	31.03.2023	AP 3Phase 3Wire				4187131	1200-600/5	2.595	NA	Director/D	
B.405	Border	GURDASPUR	11kV	DS DIVN. QADIAN	DS S/D SRI HARGOBIINDPUR	CS45FL14	Mari Bhatian	AMR	OK	31.03.2023	AP 3Phase 3Wire				53438614	1200/577/1-1-1	2.866	NA	Director/D	
B.406	Border	GURDASPUR	11kV	DS DIVN. QADIAN	DS S/D SRI HARGOBIINDPUR	CS45FL05	Mari Tanda	AMR	OK	31.03.2023	AP 3Phase 3Wire				2062874	1200/577/1-1-1	3.144	NA	Director/D	
B.407	Border	GURDASPUR	11kV	DS DIVN. QADIAN	DS S/D SRI HARGOBIINDPUR	CS45FL09	Bharth	AMR	OK	31.03.2023	AP 3Phase 3Wire				6745290	1200-600/5	3.385	NA	Director/D	
B.408	Border	GURDASPUR	11kV	DS DIVN. QADIAN	DS S/D SRI HARGOBIINDPUR	CS45FL04	Machrawan	AMR	OK	31.03.2023	AP 3Phase 3Wire				7336508	1200/577/1-1-1	3.554	NA	Director/D	
B.409	Border	GURDASPUR	11kV	DS DIVN. QADIAN	DS S/D SRI HARGOBIINDPUR	CS45FL06	Bham	AMR	OK	31.03.2023	AP 3Phase 3Wire				2066334	1200-600/5	3.741	NA	Director/D	
B.410	Border	GURDASPUR	11kV	DS DIVN. QADIAN	DS S/D SRI HARGOBIINDPUR	CS45FL07	Khokharwal	AMR	OK	31.03.2023	AP 3Phase 3Wire				5388162	1200/577/1-1-1	3.891	NA	Director/D	
B.411	Border	GURDASPUR	11kV	DS DIVN. QADIAN	DS S/D SRI HARGOBIINDPUR	CS45FL12	Machhla	AMR	OK	31.03.2023	AP 3Phase 3Wire				9141155	1200/577/1-1-1	4.095	NA	Director/D	
B.412	Border	GURDASPUR	11kV	DS DIVN. QADIAN	DS S/D SRI HARGOBIINDPUR	CS45FL12	Cheema Khuddi	NON AMR	OK	31.03.2023	Category 5-UPS				73130858	1200-600/5	6.828	NA	Director/D	
B.413	Border	GURDASPUR	11kV	DS DIVN. QADIAN	DS S/D SRI HARGOBIINDPUR	CS45FL08	Sri Hargobindpur	NON AMR	OK	31.03.2023	Category 1				4187131	1200-600/5	7.956	NA	Director/D	
B.414	Border	GURDASPUR	11kV	DS DIVN. QADIAN	DS S/D SRI HARGOBIINDPUR	CS45FL03	Rampur Talwara	AMR	OK	31.03.2023	Category 5-UPS				2066873	1200/577/1-1-1	9.153	NA	Director/D	
B.415	Border	GURDASPUR	11kV	DS DIVN. QADIAN	DS S/D SRI HARGOBIINDPUR	CS45FL11	Withwan	AMR	OK	31.03.2023	Category 5-UPS				6489700	1200/577/1-1-1	10.434	NA	Director/D	
B.416	Border	GURDASPUR	11kV	DS DIVN. QADIAN	DS S/D SRI HARGOBIINDPUR	0864FL16	PAWAZA BAINS	AMR	OK	31.03.2023	AP 3Phase 3Wire				73200529	900-450/577/1-1-1	1.047	NA	Director/D	
B.417	Border	GURDASPUR	11kV	DS DIVN. QADIAN	DS S/D SRI HARGOBIINDPUR	0864FL07	MJOR	AMR	OK	31.03.2023	AP 3Phase 3Wire				1572	900-450/577/1-1-1	1.425	NA	Director/D	
B.418	Border	GURDASPUR	11kV	DS DIVN. QADIAN	DS S/D SRI HARGOBIINDPUR	0864FL04	Bethi Pattan	AMR	OK	31.03.2023	AP 3Phase 3Wire				2066363	900-450/577/1-1-1	2.606	NA	Director/D	
B.419	Border	GURDASPUR	11kV	DS DIVN. QADIAN	DS S/D SRI HARGOBIINDPUR	0864FL03	Pinda Rori	AMR	OK	31.03.2023	AP 3Phase 3Wire				2066818	900-450/577/1-1-1	2.644	NA	Director/D	
B.420	Border	GURDASPUR	11kV	DS DIVN. QADIAN	DS S/D SRI HARGOBIINDPUR	0864FL02	Bulpur	AMR	OK	31.03.2023	AP 3Phase 3Wire				2067075	900-450/577/1-1-1	2.983	NA	Director/D	
B.421	Border	GURDASPUR	11kV	DS DIVN. QADIAN	DS S/D SRI HARGOBIINDPUR	0864FL01	Rajoa	AMR	OK	31.03.2023	Category 1				7042855	900-450/577/1-1-1	4.861	NA	Director/D	
B.422	Border	GURDASPUR	11kV	DS DIVN																

S.No	Zone	Circle	Voltage Level (kVA)	Division (kVA)	Sub-Division (kVA)	Feeder ID	Feeder Name	Feeder Metering Status (Metered/unmetered/AMR/AMI)	Status of Meter (Functional/Non-Functional)	Metering Date (Date of last actual meter reading/communication)	Feeder Type (Agr/Industrial/Mixed)	Status of Communication			Period from 01.04.2021 to 31.03.2022			Sales	Remarks (Source of data)
												% data received through automatically if feeder AMR/AMI	Number of hours when meter was unable to communicate in overall	Total Number of hours in the period	Meter S.No	CT/PT ratio	Import (kU)		
B.455	Border	GURDASPUR	11KV	DS DIVN. DHARIWAL	DS S/D KALANAUJ	0870FL10	24Hrs Khanowal	AMR	OK	31.03.2023	Category 5-UPS				23789	900-450/577/1-1-1	7.665	NA	Director/D
B.456	Border	GURDASPUR	11KV	DS DIVN. DHARIWAL	DS S/D KALANAUJ	0890FL06	Bhaldal	AMR	OK	31.03.2023	AP 3Phase 3Wire				15196088	900-450/577/1-1-1	1.999	NA	Director/D
B.457	Border	GURDASPUR	11KV	DS DIVN. DHARIWAL	DS S/D KALANAUJ	0899FL11	Parawa	AMR	OK	31.03.2023	Category 5-UPS				2647	900-450/577/1-1-1	2.984	NA	Director/D
B.458	Border	GURDASPUR	11KV	DS DIVN. DHARIWAL	DS S/D KALANAUJ	0873FL09	KAMAL PUR JATTA	AMR	OK	31.03.2023	AP 3Phase 3Wire				46373	900-450/577/1-1-1	1.117	NA	Director/D
B.459	Border	GURDASPUR	11KV	DS DIVN. DHARIWAL	DS S/D KALANAUJ	0873FL03	DEHRWAL KIRAN	AMR	OK	31.03.2023	AP 3Phase 3Wire				4180044	900-450/577/1-1-1	1.141	NA	Director/D
B.460	Border	GURDASPUR	11KV	DS DIVN. DHARIWAL	DS S/D KALANAUJ	0873FL08	24hrs Shuhar	NON AMR	OK	31.03.2023	Category 5-UPS				6486427	900-450/577/1-1-1	4.366	NA	Director/D
B.461	Border	GURDASPUR	11KV	DS DIVN. DHARIWAL	DS S/D KALANAUJ	0869FL02	B.O.P.	AMR	OK	31.03.2023	Category 4				5295703	900-450/577/1-1-1	0.586	NA	Director/D
B.462	Border	GURDASPUR	11KV	DS DIVN. DHARIWAL	DS S/D KALANAUJ	0869FL11	CHANDU WADALA	AMR	OK	31.03.2023	AP 3Phase 3Wire				2066968	900-450/577/1-1-1	0.782	NA	Director/D
B.463	Border	GURDASPUR	11KV	DS DIVN. DHARIWAL	DS S/D KALANAUJ	0869FL18	Rahimbab	AMR	OK	31.03.2023	AP 3Phase 3Wire				2741	900-450/577/1-1-1	1.026	NA	Director/D
B.464	Border	GURDASPUR	11KV	DS DIVN. DHARIWAL	DS S/D KALANAUJ	0869FL21	Whidwal	AMR	OK	31.03.2023	AP 3Phase 3Wire				4932	900-450/577/1-1-1	1.307	NA	Director/D
B.465	Border	GURDASPUR	11KV	DS DIVN. DHARIWAL	DS S/D KALANAUJ	0869FL16	Bishan Kot	AMR	OK	31.03.2023	AP 3Phase 3Wire				1575	900-450/577/1-1-1	1.355	NA	Director/D
B.466	Border	GURDASPUR	11KV	DS DIVN. DHARIWAL	DS S/D KALANAUJ	0869FL04	ROSSA	AMR	OK	31.03.2023	AP 3Phase 3Wire				4186564	900-450/577/1-1-1	1.725	NA	Director/D
B.467	Border	GURDASPUR	11KV	DS DIVN. DHARIWAL	DS S/D KALANAUJ	0869FL01	DOSTPUR	AMR	OK	31.03.2023	AP 3Phase 3Wire				2066738	900-450/577/1-1-1	1.736	NA	Director/D
B.468	Border	GURDASPUR	11KV	DS DIVN. DHARIWAL	DS S/D KALANAUJ	0869FL08	JOGOVAL	AMR	OK	31.03.2023	AP 3Phase 3Wire				2066926	900-450/577/1-1-1	1.760	NA	Director/D
B.470	Border	GURDASPUR	11KV	DS DIVN. DHARIWAL	DS S/D KALANAUJ	0869FL20	DEOL	AMR	OK	31.03.2023	AP 3Phase 3Wire				4690	900-450/577/1-1-1	1.952	NA	Director/D
B.471	Border	GURDASPUR	11KV	DS DIVN. DHARIWAL	DS S/D KALANAUJ	0869FL09	GOSSAL	AMR	OK	31.03.2023	AP 3Phase 3Wire				2067085	900-450/577/1-1-1	1.973	NA	Director/D
B.472	Border	GURDASPUR	11KV	DS DIVN. DHARIWAL	DS S/D KALANAUJ	0869FL05	DEHAR	AMR	OK	31.03.2023	AP 3Phase 3Wire				2066877	900-450/577/1-1-1	2.156	NA	Director/D
B.473	Border	GURDASPUR	11KV	DS DIVN. DHARIWAL	DS S/D KALANAUJ	0869FL06	NABI NAGAR	AMR	OK	31.03.2023	AP 3Phase 3Wire				2067533	900-450/577/1-1-1	2.275	NA	Director/D
B.474	Border	GURDASPUR	11KV	DS DIVN. DHARIWAL	DS S/D KALANAUJ	0869FL03	MASTROT	NON AMR	OK	31.03.2023	AP 3Phase 3Wire				2067509	900-450/577/1-1-1	2.202	NA	Director/D
B.475	Border	GURDASPUR	11KV	DS DIVN. DHARIWAL	DS S/D KALANAUJ	0869FL15	24Hrs Liggall	NON AMR	OK	31.03.2023	Category 5-UPS				1257298	900-450/577/1-1-1	5.353	NA	Director/D
B.476	Border	GURDASPUR	11KV	DS DIVN. DHARIWAL	DS S/D KALANAUJ	0869FL13	24Hrs DALEPUR	NON AMR	OK	31.03.2023	Category 5-UPS				6607336	900-450/577/1-1-1	6.139	NA	Director/D
B.477	Border	GURDASPUR	11KV	DS DIVN. DHARIWAL	DS S/D KALANAUJ	0869FL12	24Hrs GOWARA	NON AMR	OK	31.03.2023	Category 5-UPS				6486416	900-450/577/1-1-1	6.689	NA	Director/D
B.478	Border	GURDASPUR	11KV	DS DIVN. DHARIWAL	DS S/D KALANAUJ	0869FL14	SARICHACK	AMR	OK	31.03.2023	Category 5-UPS				11116760	900-450/577/1-1-1	9.791	NA	Director/D
B.479	Border	GURDASPUR	11KV	DS DIVN. DHARIWAL	DS S/D KALANAUJ	0869FL07	KALANOUR CITY	AMR	OK	31.03.2023	Category 1				158720	900-450/577/1-1-1	14.918	NA	Director/D
B.480	Border	GURDASPUR	11KV	DS DIVN. DHARIWAL	DS S/D N/MAHA SINGH	C85FL01	BHOPIR	AMR	OK	31.03.2023	AP 3Phase 3Wire				11116835	1200/577/1-1-1	1.686	NA	Director/D
B.481	Border	GURDASPUR	11KV	DS DIVN. DHARIWAL	DS S/D N/MAHA SINGH	0870FL03	GARGOWALI	AMR	OK	31.03.2023	AP 3Phase 3Wire				8232677	900-450/577/1-1-1	2.124	NA	Director/D
B.482	Border	GURDASPUR	11KV	DS DIVN. DHARIWAL	DS S/D N/MAHA SINGH	0870FL05	BANGOWANI	AMR	OK	31.03.2023	AP 3Phase 3Wire				2067383	900-450/577/1-1-1	2.755	NA	Director/D
B.483	Border	GURDASPUR	11KV	DS DIVN. DHARIWAL	DS S/D N/MAHA SINGH	0870FL08	24Hrs MALD GILL	AMR	OK	31.03.2023	Category 5-UPS				6489712	900-450/577/1-1-1	5.331	NA	Director/D
B.484	Border	GURDASPUR	11KV	DS DIVN. DHARIWAL	DS S/D N/MAHA SINGH	0890FL09	Dullanagal	AMR	OK	31.03.2023	AP 3Phase 3Wire				248062	900-450/577/1-1-1	3.104	NA	Director/D
B.485	Border	GURDASPUR	11KV	DS DIVN. DHARIWAL	DS S/D N/MAHA SINGH	0899FL01	Bhopal	AMR	OK	31.03.2023	Category 5-UPS				24905	900-450/577/1-1-1	3.795	NA	Director/D
B.486	Border	GURDASPUR	11KV	DS DIVN. DHARIWAL	DS S/D N/MAHA SINGH	0867FL02	BARKA	AMR	OK	31.03.2023	AP 3Phase 3Wire				2067643	900-450/577/1-1-1	4.262	NA	Director/D
B.487	Border	GURDASPUR	11KV	DS DIVN. DHARIWAL	DS S/D N/MAHA SINGH	0867FL05	JPRAL	AMR	OK	31.03.2023	AP 3Phase 3Wire				6761940	900-450/577/1-1-1	1.923	NA	Director/D
B.488	Border	GURDASPUR	11KV	DS DIVN. DHARIWAL	DS S/D N/MAHA SINGH	0867FL01	N.M.SINGH	AMR	OK	31.03.2023	AP 3Phase 3Wire				422106	900-450/577/1-1-1	2.324	NA	Director/D
B.489	Border	GURDASPUR	11KV	DS DIVN. DHARIWAL	DS S/D N/MAHA SINGH	0867FL04	BULEVAL	AMR	OK	31.03.2023	AP 3Phase 3Wire				2066788	900-450/577/1-1-1	2.369	NA	Director/D
B.490	Border	GURDASPUR	11KV	DS DIVN. DHARIWAL	DS S/D N/MAHA SINGH	0867FL13	SDHWAL	AMR	OK	31.03.2023	AP 3Phase 3Wire				11116986	900-450/577/1-1-1	2.455	NA	Director/D
B.491	Border	GURDASPUR	11KV	DS DIVN. DHARIWAL	DS S/D N/MAHA SINGH	0867FL03	GHUMAN	AMR	OK	31.03.2023	AP 3Phase 3Wire				2067370	900-450/577/1-1-1	3.205	NA	Director/D
B.492	Border	GURDASPUR	11KV	DS DIVN. DHARIWAL	DS S/D N/MAHA SINGH	0867FL12	BEHVAL CHACK	AMR	OK	31.03.2023	Category 5-UPS				427204	900-450/577/1-1-1	7.511	NA	Director/D
B.493	Border	GURDASPUR	11KV	DS DIVN. DHARIWAL	DS S/D N/MAHA SINGH	0867FL06	BHOBA SAHIB	AMR	OK	31.03.2023	Category 5-UPS				11116746	900-450/577/1-1-1	8.545	NA	Director/D
B.494	Border	GURDASPUR	11KV	DS DIVN. DHARIWAL	DS S/D N/MAHA SINGH	0867FL08	24Hrs U.P.S. KOTLA CHAHAL	AMR	OK	31.03.2023	Category 5-UPS				7436520	900-450/577/1-1-1	10.110	NA	Director/D
B.495	Border	GURDASPUR	11KV	DS DIVN. DHARIWAL	DS CITY S/D GURDASPUR	C85FL14	Tibbeni Road	AMR	OK	31.03.2023	Category 1				9154049	1200-600/5	0.000	NA	Director/D
B.496	Border	GURDASPUR	11KV	DS DIVN. DHARIWAL	DS CITY S/D GURDASPUR	C85FL11	Nabipur	NON AMR	OK	31.03.2023	AP 3Phase 3Wire				2066519	1200-600/5	1.210	NA	Director/D
B.497	Border	GURDASPUR	11KV	DS DIVN. DHARIWAL	DS CITY S/D GURDASPUR	C85FL10	Kalanauj	NON AMR	OK	31.03.2023	AP 3Phase 3Wire				2066576	1200-600/5	1.849	NA	Director/D
B.498	Border	GURDASPUR	11KV	DS DIVN. DHARIWAL	DS CITY S/D GURDASPUR	C85FL07	Hospital	AMR	OK	31.03.2023	Category 4				2067338	1200-600/5	1.896	NA	Director/D
B.499	Border	GURDASPUR	11KV	DS DIVN. DHARIWAL	DS CITY S/D GURDASPUR	C85FL08	Pearanbagh	NON AMR	OK	31.03.2023	AP 3Phase 3Wire				2066700	1200-600/5	2.055	NA	Director/D
B.500	Border	GURDASPUR	11KV	DS DIVN. DHARIWAL	DS CITY S/D GURDASPUR	C85FL12	Gatta Factory	AMR	OK	31.03.2023	Category 2				2067406	1200-600/5	3.624	NA	Director/D
B.501	Border	GURDASPUR	11KV	DS DIVN. DHARIWAL	DS CITY S/D GURDASPUR	C85FL15	Geeta Bhanwar Road	NON AMR	OK	31.03.2023	Category 1				1662620	1200-600/5	5.630	NA	Director/D
B.502	Border	GURDASPUR	11KV	DS DIVN. DHARIWAL	DS CITY S/D GURDASPUR	C85FL04	SidhuChack	AMR	OK	31.03.2023	Category 5-UPS				1252573	1200-600/5	6.876	NA	Director/D
B.503	Border	GURDASPUR	11KV	DS DIVN. DHARIWAL	DS CITY S/D GURDASPUR	C85FL05	Ch	NON AMR	OK	31.03.2023	Category 1				2067653	1200-600/5	12.598	NA	Director/D
B.504	Border	GURDASPUR	11KV	DS DIVN. DHARIWAL	DS CITY S/D GURDASPUR	C85FL13	Trimro Road	AMR	OK	31.03.2023	Category 1				2066753	1200-600/5	16.089	NA	Director/D
B.505	Border	GURDASPUR	11KV	DS DIVN. DHARIWAL	DS CITY S/D GURDASPUR	DTG3FL03	SD Collage	AMR	OK	31.03.2023	Category 1				583682	900-450/577/1-1-1	11.938	NA	Director/D
B.506	Border	GURDASPUR	11KV	DS DIVN. DHARIWAL	DS CITY S/D GURDASPUR	NAG1FL04	Puda No. 1	AMR	OK	31.03.2023	Category 1				3625	1200/577/1-1-1	0.443	NA	Director/D
B.507	Border	GURDASPUR	11KV	DS DIVN. DHARIWAL	DS CITY S/D GURDASPUR	NAG1FL05	Puda No 2	AMR	OK	31.03.2023	Category 1				3583	1200/577/1-1-1	0.932	NA	Director/D
B.508	Border	GURDASPUR	11KV	DS DIVN. DHARIWAL	DS CITY S/D GURDASPUR	NAG1FL06	BARKA	AMR	OK	31.03.2023	Category 5-UPS				36328	900-450/577/1-1-1	4.262	NA	Director/D
B.509	Border	GURDASPUR	11KV	DS DIVN. DHARIWAL	DS CITY S/D GURDASPUR	NAG1FL07	New Batala Road	AMR	OK	31.03.2023	Category 1				3592	1200/577/1-1-1	6.323	NA	Director/D
B.510	Border	GURDASPUR	11KV	DS DIVN. DHARIWAL	DS CITY S/D GURDASPUR	NAG1FL06	Geeta Bhanwar No-2	AMR	OK	31.03.2023	Category 1				3616	1200/577/1-1-1	9.301	NA	Director/D
B.511	Border	GURDASPUR	11KV	DS DIVN. DHARIWAL	DS S/D BEHRAMPUR	DG11FL04	Jogar	AMR	OK	31.03.2023	AP 3Phase 3Wire				15192337	900-450/577/1-1-1	0.574	NA	Director/D
B.512	Border	GURDASPUR	11KV	DS DIVN. DHARIWAL	DS S/D BEHRAMPUR	DG11FL02	Marara-1	AMR	OK	31.03.2023	AP 3Phase 3Wire				43152	900-450/577/1-1-1	0.602	NA	Director/D
B.513	Border	GURDASPUR	11KV	DS DIVN. DHARIWAL	DS S/D BEHRAMPUR	DG11FL05	Manwar	AMR	OK	31.03.2023	Category 5-UPS				2067808	900-450/577/1-1-1	0.766	NA	Director/D
B.514	Border	GURDASPUR	11KV	DS DIVN. DHARIWAL	DS S/D BEHRAMPUR	DG11FL03	Bharth-1	AMR	OK	31.03.2023	AP 3Phase 3Wire				1592300	900-450/577/1-1-1	0.874	NA	Director/D
B.515	Border	GURDASPUR	11KV	DS DIVN. DHARIWAL	DS S/D BEHRAMPUR	DG11FL01	Daburj	AMR	OK	31.03.2023	Category 5-UPS				1580245	900-450/577/1-1-1	6.468	NA	Director/D
B.516	Border	GURDASPUR	11KV	DS DIVN. DHARIWAL	DS S/D BEHRAMPUR	DG11FL06	BEHRAMPUR	AMR	OK	31.03.2023	Category 5-UPS				16194448	900-450/577/1-1-1	10.091	NA	Director/D
B.517	Border	GURDASPUR	11KV	DS DIVN. DHARIWAL	DS S/D BEHRAMPUR	0874FL08	Bharth	AMR	OK	31.03.2023	AP 3Phase 3Wire				4179693	1200/577/1-1-1	0.567	NA	Director/D
B.518	Border	GURDASPUR	11KV	DS DIVN. DHARIWAL	DS S/D BEHRAMPUR	0874FL04	Banthalwal	AMR	OK	31.03.2023	AP 3Phase 3Wire				8222683	900-450/577/1-1-1	1.492	NA	Director/D
B.519	Border	GURDASPUR	11KV	DS DIVN.															

S.No	Zone	Circle	Voltage (kVA)	Division (kVA)	Sub-Division (kVA)	Feeder ID	Feeder Name	Feeder Metering Status (Metered/unmetered/AM/AMR)	Status of Meter (Functional/Non-functional)	Metering Date	Date of last actual meter reading/communication	Feeder Type (Agr/Industrial/Mixed)	Status of Communication			Period from 01.04.2021 to 31.03.2022			Sales	Remarks (Source of data)
													% data received through automatically if feeder AMR/AM	Number of hours when meter was unable to communicate in overall	Total Number of hours in the period	Meter S.No	CT/PT ratio	Import (kWh)		
B.552	Border	GURDASPUR	11KV	DS DIVN. GURDASPUR	DS S/D JOURAN CHHITRAN	0868FL04	24Hrs. GUNIAN	AMR	OK	31.03.2023		Category 5-UPS				2068197	900-450/577/1-1-1	3.621	NA	Director/D
B.553	Border	GURDASPUR	11KV	DS DIVN. GURDASPUR	DS S/D JOURAN CHHITRAN	0868FL17	Heer	AMR	OK	31.03.2023		Category 5-UPS				3060	900-450/577/1-1-1	5.803	NA	Director/D
B.554	Border	GURDASPUR	11KV	DS DIVN. GURDASPUR	DS S/D JOURAN CHHITRAN	0868FL13	24Hrs MOUR	AMR	OK	31.03.2023		Category 5-UPS				12054	900-450/577/1-1-1	6.389	NA	Director/D
B.555	Border	GURDASPUR	11KV	DS DIVN. GURDASPUR	DS S/D JOURAN CHHITRAN	0868FL15	24 Hrs Ambar	NON AMR	OK	31.03.2023		Category 5-UPS				21023	900-450/577/1-1-1	7.203	NA	Director/D
B.556	Border	GURDASPUR	11KV	DS DIVN. GURDASPUR	DS S/D JOURAN CHHITRAN	0868FL14	24Hrs. Salimpur	AMR	OK	31.03.2023		Category 5-UPS				9154093	900-450/577/1-1-1	9.787	NA	Director/D
B.557	Border	GURDASPUR	11KV	DS DIVN. GURDASPUR	DS S/D PURANA SHELLA	0873FL05	Chawa	AMR	OK	31.03.2023		AP 3Phase 3Wire				36732	900-450/577/1-1-1	0.192	NA	Director/D
B.558	Border	GURDASPUR	11KV	DS DIVN. GURDASPUR	DS S/D PURANA SHELLA	0873FL08	Bhaini Meelma	AMR	OK	31.03.2023		AP 3Phase 3Wire				2068160	900-450/577/1-1-1	0.484	NA	Director/D
B.559	Border	GURDASPUR	11KV	DS DIVN. GURDASPUR	DS S/D PURANA SHELLA	0873FL03	Bhattan	AMR	OK	31.03.2023		AP 3Phase 3Wire				34172	900-450/577/1-1-1	0.689	NA	Director/D
B.560	Border	GURDASPUR	11KV	DS DIVN. GURDASPUR	DS S/D PURANA SHELLA	0873FL01	Jagatpur	AMR	OK	31.03.2023		AP 3Phase 3Wire				36928	900-450/577/1-1-1	0.755	NA	Director/D
B.561	Border	GURDASPUR	11KV	DS DIVN. GURDASPUR	DS S/D PURANA SHELLA	0873FL10	Kishampur	AMR	OK	31.03.2023		AP 3Phase 3Wire				36717	900-450/577/1-1-1	1.158	NA	Director/D
B.562	Border	GURDASPUR	11KV	DS DIVN. GURDASPUR	DS S/D PURANA SHELLA	0873FL09	Jagatpur Tanda	NON AMR	OK	31.03.2023		Category 5-UPS				6489715	900-450/577/1-1-1	2.725	NA	Director/D
B.563	Border	GURDASPUR	11KV	DS DIVN. GURDASPUR	DS S/D PURANA SHELLA	0873FL07	24 Hrs. Bhattan	AMR	OK	31.03.2023		Category 5-UPS				5435499	900-450/577/1-1-1	5.001	NA	Director/D
B.564	Border	GURDASPUR	11KV	DS DIVN. GURDASPUR	DS S/D PURANA SHELLA	0873FL11	Jagowal bet	AMR	OK	31.03.2023		Category 5-UPS				36717	900-450/577/1-1-1	6.323	NA	Director/D
B.565	Border	GURDASPUR	11KV	DS DIVN. GURDASPUR	DS S/D PURANA SHELLA	0873FL04	Shalla Urban	AMR	OK	31.03.2023		Category 5-UPS				36720	900-450/577/1-1-1	6.524	NA	Director/D
B.566	Border	GURDASPUR	11KV	DS DIVN. GURDASPUR	DS S/D TIBBAR	0854FL09	Kotlianpur	AMR	OK	31.03.2023		AP 3Phase 3Wire				7335493	1200-600/5	1.195	NA	Director/D
B.567	Border	GURDASPUR	11KV	DS DIVN. GURDASPUR	DS S/D TIBBAR	0854FL04	Talwandiwhir	AMR	OK	31.03.2023		AP 3Phase 3Wire				2067801	1200-600/5	1.472	NA	Director/D
B.568	Border	GURDASPUR	11KV	DS DIVN. GURDASPUR	DS S/D TIBBAR	0854FL03	Tibbar	AMR	OK	31.03.2023		AP 3Phase 3Wire				8222590	1200-600/5	1.623	NA	Director/D
B.569	Border	GURDASPUR	11KV	DS DIVN. GURDASPUR	DS S/D TIBBAR	0854FL01	Sujanpur	AMR	OK	31.03.2023		AP 3Phase 3Wire				8223421	1200-600/5	2.353	NA	Director/D
B.570	Border	GURDASPUR	11KV	DS DIVN. GURDASPUR	DS S/D TIBBAR	0854FL08	Ratowal	AMR	OK	31.03.2023		AP 3Phase 3Wire				4186066	1200-600/5	2.560	NA	Director/D
B.571	Border	GURDASPUR	11KV	DS DIVN. GURDASPUR	DS S/D TIBBAR	0854FL06	Bajethack	AMR	OK	31.03.2023		AP 3Phase 3Wire				8223636	1200-600/5	2.593	NA	Director/D
B.572	Border	GURDASPUR	11KV	DS DIVN. GURDASPUR	DS S/D TIBBAR	0854FL07	Bhumth	AMR	OK	31.03.2023		AP 3Phase 3Wire				7030205	1200/577/1-1-1	3.558	NA	Director/D
B.573	Border	GURDASPUR	11KV	DS DIVN. GURDASPUR	DS S/D TIBBAR	0854FL11	Khundi	NON AMR	OK	31.03.2023		Category 5-UPS				45108	1200/577/1-1-1	5.373	NA	Director/D
B.574	Border	GURDASPUR	11KV	DS DIVN. GURDASPUR	DS S/D TIBBAR	0854FL05	Babbari Nangal	NON AMR	OK	31.03.2023		Category 5-UPS				6740679	1200-600/5	6.107	NA	Director/D
B.575	Border	GURDASPUR	11KV	DS DIVN. GURDASPUR	DS S/D TIBBAR	0854FL10	Gunjan	AMR	OK	31.03.2023		Category 5-UPS				6675946	1200-600/5	8.198	NA	Director/D
B.576	Border	GURDASPUR	11KV	DS DIVN. GURDASPUR	DS S/D TIBBAR	0854FL04	Bhullechack	AMR	OK	31.03.2023		AP 3Phase 3Wire				7346627	900-450/577/1-1-1	1.719	NA	Director/D
B.577	Border	GURDASPUR	11KV	DS DIVN. GURDASPUR	DS S/D TIBBAR	0854FL01	Goal Mandir	NON AMR	OK	31.03.2023		AP 3Phase 3Wire				7346635	900-450/577/1-1-1	2.425	NA	Director/D
B.578	Border	GURDASPUR	11KV	DS DIVN. GURDASPUR	DS S/D TIBBAR	0854FL02	Babehali	AMR	OK	31.03.2023		Category 5-UPS				7346633	900-450/577/1-1-1	3.024	NA	Director/D
B.579	Border	GURDASPUR	11KV	DS DIVN. GURDASPUR	DS S/D TIBBAR	0854FL05	Patra	NON AMR	OK	31.03.2023		Category 5-UPS				15192310	900-450/577/1-1-1	3.444	NA	Director/D
B.580	Border	GURDASPUR	11KV	DS DIVN. GURDASPUR	DS S/D TIBBAR	0854FL03	Ghurala	Not available	OK	31.03.2023		Category 5-UPS				7446632	900-450/577/1-1-1	5.248	NA	Director/D
B.581	Border	GURDASPUR	66KV	DS DIVN. GURDASPUR	DS S/D TIBBAR	08540854	66 kv Tibbar Kainth	NON AMR	OK	31.03.2023		Category 4				Not available	Not available	12.323	NA	Director/D
B.582	Border	GURDASPUR	11KV	DS DIVN. GURDASPUR	DS S/U S/D GURDASPUR	0258FL02	Batala Road	AMR	OK	31.03.2023		Category 1				2993733	1200-800/5	0.000	NA	Director/D
B.583	Border	GURDASPUR	11KV	DS DIVN. GURDASPUR	DS S/U S/D GURDASPUR	0258FL16	Barnala	NON AMR	OK	31.03.2023		AP 3Phase 3Wire				2067647	1200-600/5	2.471	NA	Director/D
B.584	Border	GURDASPUR	11KV	DS DIVN. GURDASPUR	DS S/U S/D GURDASPUR	0258FL01	Meerpur	NON AMR	OK	31.03.2023		Category 5-UPS				2067218	1200-600/5	13.034	NA	Director/D
B.585	Border	GURDASPUR	11KV	DS DIVN. GURDASPUR	DS S/U S/D GURDASPUR	0258FL03	Mandi	AMR	OK	31.03.2023		Category 1				2067635	1200-600/5	15.805	NA	Director/D
B.586	Border	GURDASPUR	11KV	DS DIVN. GURDASPUR	DS S/U S/D GURDASPUR	0258FL04	Improvement Trust	AMR	OK	31.03.2023		Category 1				73151227	900-450/577/1-1-1	11.343	NA	Director/D
B.587	Border	GURDASPUR	11KV	DS DIVN. GURDASPUR	DS S/U S/D GURDASPUR	07G3FL01	Baba Tehal Singh	AMR	OK	31.03.2023		Category 1				583894	900-450/577/1-1-1	10.962	NA	Director/D
B.588	Border	GURDASPUR	11KV	DS DIVN. GURDASPUR	DS S/U S/D GURDASPUR	07G3FL02	Govt Mandir	NON AMR	OK	31.03.2023		Category 1				25015	900-450/577/1-1-1	11.081	NA	Director/D
B.589	Border	GURDASPUR	11KV	DS DIVN. GURDASPUR	DS S/U S/D GURDASPUR	0872FL08	Beant Coll.	AMR	OK	31.03.2023		Category 4				2067981	1200/577/1-1-1	6.619	NA	Director/D
B.590	Border	GURDASPUR	11KV	DS DIVN. GURDASPUR	DS S/U S/D GURDASPUR	0872FL16	Mokhe	AMR	OK	31.03.2023		AP 3Phase 3Wire				37707	1200/577/1-1-1	0.722	NA	Director/D
B.591	Border	GURDASPUR	11KV	DS DIVN. GURDASPUR	DS S/U S/D GURDASPUR	0872FL01	Nanonangal	AMR	OK	31.03.2023		AP 3Phase 3Wire				2067882	1200/577/1-1-1	1.859	NA	Director/D
B.592	Border	GURDASPUR	11KV	DS DIVN. GURDASPUR	DS S/U S/D GURDASPUR	0872FL03	Kharal	NON AMR	OK	31.03.2023		AP 3Phase 3Wire				2067900	1200/577/1-1-1	2.096	NA	Director/D
B.593	Border	GURDASPUR	11KV	DS DIVN. GURDASPUR	DS S/U S/D GURDASPUR	0872FL13	S.S. Nagar	NON AMR	OK	31.03.2023		Category 2				5264440	1200/577/1-1-1	2.177	NA	Director/D
B.594	Border	GURDASPUR	11KV	DS DIVN. GURDASPUR	DS S/U S/D GURDASPUR	0872FL06	Mehi Pur	AMR	OK	31.03.2023		Category 4				7030210	1200/577/1-1-1	2.261	NA	Director/D
B.595	Border	GURDASPUR	11KV	DS DIVN. GURDASPUR	DS S/U S/D GURDASPUR	0872FL17	Civil line	NON AMR	OK	31.03.2023		Category 1				2795	1200/577/1-1-1	6.253	NA	Director/D
B.596	Border	GURDASPUR	11KV	DS DIVN. GURDASPUR	DS S/U S/D GURDASPUR	0872FL15	Sahawal	NON AMR	OK	31.03.2023		Category 5-UPS				2067941	1200/577/1-1-1	7.554	NA	Director/D
B.597	Border	GURDASPUR	11KV	DS DIVN. GURDASPUR	DS S/U S/D GURDASPUR	0872FL02	L.T.I	AMR	OK	31.03.2023		Category 1				2068025	1200/577/1-1-1	7.749	NA	Director/D
B.598	Border	GURDASPUR	11KV	DS S/U DIVN. BATALA	DS CITY S/D FATEHGARH CHURIAN	8803FL04	GOVT. DAIRY	AMR	OK	31.03.2023		Category 1				13184	200-100/5-5	0.288	NA	Director/D
B.599	Border	GURDASPUR	11KV	DS S/U DIVN. BATALA	DS CITY S/D FATEHGARH CHURIAN	8803FL01	BHADLOWAL	AMR	OK	31.03.2023		AP 3Phase 3Wire				803770	200-100/5-5	0.023	NA	Director/D
B.600	Border	GURDASPUR	11KV	DS S/U DIVN. BATALA	DS CITY S/D FATEHGARH CHURIAN	8803FL02	NANAK DARI	AMR	OK	31.03.2023		Category 1				7042889	200-100/5-5	0.500	NA	Director/D
B.601	Border	GURDASPUR	11KV	DS S/U DIVN. BATALA	DS CITY S/D FATEHGARH CHURIAN	8803FL17	VEELA	AMR	OK	31.03.2023		AP 3Phase 3Wire				2067318	200-100/5-5	1.104	NA	Director/D
B.602	Border	GURDASPUR	11KV	DS S/U DIVN. BATALA	DS CITY S/D FATEHGARH CHURIAN	8803FL10	PARCHA	AMR	OK	31.03.2023		AP 3Phase 3Wire				2066761	200-100/5-5	1.152	NA	Director/D
B.603	Border	GURDASPUR	11KV	DS S/U DIVN. BATALA	DS CITY S/D FATEHGARH CHURIAN	8803FL12	CHITTORGARH	AMR	OK	31.03.2023		AP 3Phase 3Wire				2067127	200-100/5-5	1.367	NA	Director/D
B.604	Border	GURDASPUR	11KV	DS S/U DIVN. BATALA	DS CITY S/D FATEHGARH CHURIAN	8803FL08	KHOKHER	AMR	OK	31.03.2023		AP 3Phase 3Wire				2067192	200-100/5-5	1.406	NA	Director/D
B.605	Border	GURDASPUR	11KV	DS S/U DIVN. BATALA	DS CITY S/D FATEHGARH CHURIAN	8803FL11	DOGER	AMR	OK	31.03.2023		AP 3Phase 3Wire				2067223	200-100/5-5	1.469	NA	Director/D
B.606	Border	GURDASPUR	11KV	DS S/U DIVN. BATALA	DS CITY S/D FATEHGARH CHURIAN	8803FL03	DOGER	AMR	OK	31.03.2023		AP 3Phase 3Wire				2067378	200-100/5-5	1.796	NA	Director/D
B.607	Border	GURDASPUR	11KV	DS S/U DIVN. BATALA	DS CITY S/D FATEHGARH CHURIAN	8803FL11	BADHOWAL	AMR	OK	31.03.2023		AP 3Phase 3Wire				2067199	200-100/5-5	2.135	NA	Director/D
B.608	Border	GURDASPUR	11KV	DS S/U DIVN. BATALA	DS CITY S/D FATEHGARH CHURIAN	8803FL07	PINDI	AMR	OK	31.03.2023		AP 3Phase 3Wire				2067094	200-100/5-5	2.539	NA	Director/D
B.609	Border	GURDASPUR	11KV	DS S/U DIVN. BATALA	DS CITY S/D FATEHGARH CHURIAN	8803FL19	MANSANDWAL	AMR	OK	31.03.2023		Category 5-UPS				4263509	200-100/5-5	9.620	NA	Director/D
B.610	Border	GURDASPUR	11KV	DS S/U DIVN. BATALA	DS CITY S/D FATEHGARH CHURIAN	8803FL20	BARAN RAILWAY ROAD FEEDER	AMR	OK	31.03.2023		Category 1				2068189	200-100/5-5	9.664	NA	Director/D
B.611	Border	GURDASPUR	11KV	DS S/U DIVN. BATALA	DS CITY S/D FATEHGARH CHURIAN	8803FL19	HARDRAWAL KALAN	AMR	OK	31.03.2023		Category 5-UPS				1026300	200-100/5-5	12.125	NA	Director/D
B.612	Border	GURDASPUR	11KV	DS S/U DIVN. BATALA	DS CITY S/D FATEHGARH CHURIAN	8803FL13	URBAN FATEHGARH CHURIAN FEEDER	AMR	OK	31.03.2023		Category 1				4263571	200-100/5-5	14.277	NA	Director/D
B.613	Border	GURDASPUR	11KV	DS S/U DIVN. BATALA	DS CITY S/D FATEHGARH CHURIAN	0857FL11	muredkey	AMR	OK	31.03.2023		AP 3Phase 3Wire				7316208	900-450/577/1-1-1	1.770</		

S.No	Zone	Circle	Voltage Level (kVA)	Division (kVA)	Sub-Division (kVA)	Feeder ID	Feeder Name	Feeder Metering Status (Metered/unmetered/AM/AMR)	Status of Meter (Functional/Non-Functional)	Metering Date	Date of last actual meter reading/communication	Feeder Type (Agr/Industrial/Mixed)	Status of Communication			Period from 01.04.2021 to 31.03.2022				Sales	Remarks (Source of data)
													% data received through automatically if feeder AMR/AM	Number of hours when meter was unable to communicate in overall	Total Number of hours in the period	Meter S.No	CT/PT ratio	Import (kWh)	Export (kWh)		
B.649	Border	GURDASPUR	11kV	DS S/D DIVN. BATALA	DS S/D ALIHWAL	DBS7FL13	SHEERA	AMR	OK	31.03.2023		AP 3Phase 3Wire				4922	900-450/5	1,491	NA	Director/D	
B.650	Border	GURDASPUR	11kV	DS S/D DIVN. BATALA	DS S/D ALIHWAL	DBS7FL09	11 KV LANGERWAL	AMR	OK	31.03.2023		AP 3Phase 3Wire				25481	900-450/577/1-1	1,496	NA	Director/D	
B.651	Border	GURDASPUR	11kV	DS S/D DIVN. BATALA	DS S/D ALIHWAL	DBS7FL02	Azampur	AMR	OK	31.03.2023		AP 3Phase 3Wire				2068671	900-450/5	1,501	NA	Director/D	
B.652	Border	GURDASPUR	11kV	DS S/D DIVN. BATALA	DS S/D ALIHWAL	DBS7FL03	Phawal	AMR	OK	31.03.2023		AP 3Phase 3Wire				8141039	900-450/5	1,514	NA	Director/D	
B.653	Border	GURDASPUR	11kV	DS S/D DIVN. BATALA	DS S/D ALIHWAL	DBS7FL01	Kala Algana Rural	AMR	OK	31.03.2023		AP 3Phase 3Wire				9140832	900-450/5	1,850	NA	Director/D	
B.654	Border	GURDASPUR	11kV	DS S/D DIVN. BATALA	DS S/D ALIHWAL	DBS7FL05	Kala Algana 24 Hr	AMR	OK	31.03.2023		Category 5-UPS				7035622	900-450/577/1-1	10,855	NA	Director/D	
B.655	Border	GURDASPUR	11kV	DS S/D DIVN. BATALA	DS S/D DERA BABA NANAK	DBS3FL14	11KV SHIKAR DUMP	AMR	OK	31.03.2023		Category 4				1209354	400-200/5	0,097	NA	Director/D	
B.656	Border	GURDASPUR	11kV	DS S/D DIVN. BATALA	DS S/D DERA BABA NANAK	DBS9FL15	Sh. Kartarpur Sahib Corridor	AMR	OK	31.03.2023		Category 4				3945	900-450/577/1-1	0,695	NA	Director/D	
B.657	Border	GURDASPUR	11kV	DS S/D DIVN. BATALA	DS S/D DERA BABA NANAK	DBS9FL03	Shriee Ke Bet	AMR	OK	31.03.2023		AP 3Phase 3Wire				10283764	900-450/577/1-1	0,742	NA	Director/D	
B.658	Border	GURDASPUR	11kV	DS S/D DIVN. BATALA	DS S/D DERA BABA NANAK	DBS9FL01	Dharamkot	AMR	OK	31.03.2023		AP 3Phase 3Wire				2066824	900-450/577/1-1	1,161	NA	Director/D	
B.659	Border	GURDASPUR	11kV	DS S/D DIVN. BATALA	DS S/D DERA BABA NANAK	DBS9FL04	B.O.P.	AMR	OK	31.03.2023		Category 4				23357	900-450/577/1-1	1,502	NA	Director/D	
B.660	Border	GURDASPUR	11kV	DS S/D DIVN. BATALA	DS S/D DERA BABA NANAK	DBS9FL08	Shikar	AMR	OK	31.03.2023		AP 3Phase 3Wire				2066168	900-450/577/1-1	1,509	NA	Director/D	
B.661	Border	GURDASPUR	11kV	DS S/D DIVN. BATALA	DS S/D DERA BABA NANAK	DBS9FL06	Mangian	AMR	OK	31.03.2023		AP 3Phase 3Wire				12527307	900-450/577/1-1	1,056	NA	Director/D	
B.662	Border	GURDASPUR	11kV	DS S/D DIVN. BATALA	DS S/D DERA BABA NANAK	DBS9FL09	Talwandi Goraya	AMR	OK	31.03.2023		AP 3Phase 3Wire				6740753	900-450/577/1-1	1,670	NA	Director/D	
B.663	Border	GURDASPUR	11kV	DS S/D DIVN. BATALA	DS S/D DERA BABA NANAK	DBS9FL05	Abadi	NON AMR	OK	31.03.2023		AP 3Phase 3Wire				6740994	900-450/577/1-1	1,683	NA	Director/D	
B.664	Border	GURDASPUR	11kV	DS S/D DIVN. BATALA	DS S/D DERA BABA NANAK	DBS9FL10	M.E.S.	AMR	OK	31.03.2023		Category 4				910202	900-450/577/1-1	2,046	NA	Director/D	
B.665	Border	GURDASPUR	11kV	DS S/D DIVN. BATALA	DS S/D DERA BABA NANAK	DBS9FL14	THEATHERE 24Hrs	NON AMR	OK	31.03.2023		Category 5-UPS				9534393	900-450/577/1-1	3,813	NA	Director/D	
B.666	Border	GURDASPUR	11kV	DS S/D DIVN. BATALA	DS S/D DERA BABA NANAK	DBS9FL12	Abdaal 24 Hrs.	AMR	OK	31.03.2023		Category 5-UPS				4475529	900-450/577/1-1	6,582	NA	Director/D	
B.667	Border	GURDASPUR	11kV	DS S/D DIVN. BATALA	DS S/D DERA BABA NANAK	DBS9FL02	City Feeder	NON AMR	OK	31.03.2023		Category 1				23257	900-450/577/1-1	9,459	NA	Director/D	
B.668	Border	GURDASPUR	11kV	DS S/D DIVN. BATALA	DS S/D DERA BABA NANAK	DBS9FL13	Shikar 24 Hrs	AMR	OK	31.03.2023		Category 5-UPS				7042938	900-450/577/1-1	10,405	NA	Director/D	
B.669	Border	GURDASPUR	11kV	DS S/D DIVN. BATALA	DS S/D DERA BABA NANAK	DBS9FL01	SHAR	AMR	OK	31.03.2023		AP 3Phase 3Wire				10283017	900-450/577/1-1	1,113	NA	Director/D	
B.670	Border	GURDASPUR	11kV	DS S/D DIVN. BATALA	DS S/D DERA BABA NANAK	DBS9FL03	BHAGTHANA TULIAN	AMR	OK	31.03.2023		AP 3Phase 3Wire				10283001	900-450/577/1-1	1,404	NA	Director/D	
B.671	Border	GURDASPUR	11kV	DS S/D DIVN. BATALA	DS S/D DERA BABA NANAK	DBS9FL02	SHAHPUR GORAYA AP	NON AMR	OK	31.03.2023		AP 3Phase 3Wire				10283024	900-450/577/1-1	1,849	NA	Director/D	
B.672	Border	GURDASPUR	11kV	DS S/D DIVN. BATALA	DS S/D DERA BABA NANAK	DBS9FL01	SHAHPUR GORAYA 24Hrs	NON AMR	OK	31.03.2023		Category 5-UPS				10282979	900-450/577/1-1	8,619	NA	Director/D	
B.673	Border	GURDASPUR	11kV	DS S/D DIVN. BATALA	DS S/D DERA BABA NANAK	DBS9FL16	SHAHPUR JAIAN	AMR	OK	31.03.2023		Category 1				6188	900-450/577/1-1	0,484	NA	Director/D	
B.674	Border	GURDASPUR	11kV	DS S/D DIVN. BATALA	DS S/D DERA BABA NANAK	DBS9FL14	KATHALIA	AMR	OK	31.03.2023		AP 3Phase 3Wire				4956	900-450/577/1-1	0,907	NA	Director/D	
B.675	Border	GURDASPUR	11kV	DS S/D DIVN. BATALA	DS S/D DERA BABA NANAK	DBS9FL09	PADDY	AMR	OK	31.03.2023		AP 3Phase 3Wire				73131590	900-450/577/1-1	0,988	NA	Director/D	
B.676	Border	GURDASPUR	11kV	DS S/D DIVN. BATALA	DS S/D DERA BABA NANAK	DBS9FL06	Rampura	AMR	OK	31.03.2023		AP 3Phase 3Wire				4281176	900-450/577/1-1	1,078	NA	Director/D	
B.677	Border	GURDASPUR	11kV	DS S/D DIVN. BATALA	DS S/D DERA BABA NANAK	DBS9FL05	Ldhawal	AMR	OK	31.03.2023		AP 3Phase 3Wire				7336531	900-450/577/1-1	1,154	NA	Director/D	
B.678	Border	GURDASPUR	11kV	DS S/D DIVN. BATALA	DS S/D DERA BABA NANAK	DBS9FL02	Talwandi Rama	AMR	OK	31.03.2023		AP 3Phase 3Wire				7336672	900-450/577/1-1	1,492	NA	Director/D	
B.679	Border	GURDASPUR	11kV	DS S/D DIVN. BATALA	DS S/D DERA BABA NANAK	DBS9FL15	TARUWAL	NON AMR	OK	31.03.2023		AP 3Phase 3Wire				4391	900-450/577/1-1	1,880	NA	Director/D	
B.680	Border	GURDASPUR	11kV	DS S/D DIVN. BATALA	DS S/D DERA BABA NANAK	DBS9FL01	Shahpur 24hrs	NON AMR	OK	31.03.2023		Category 5-UPS				2067840	900-450/577/1-1	6,370	NA	Director/D	
B.681	Border	GURDASPUR	11kV	DS S/D DIVN. BATALA	DS S/D DERA BABA NANAK	DBS9FL08	Nikokaran 24 Hrs	AMR	OK	31.03.2023		Category 5-UPS				667555	900-450/577/1-1	6,696	NA	Director/D	
B.682	Border	GURDASPUR	11kV	DS S/D DIVN. BATALA	DS S/D DERA BABA NANAK	DBS9FL03	MEGA	AMR	OK	31.03.2023		AP 3Phase 3Wire				10282970	900-450/577/1-1	0,577	NA	Director/D	
B.683	Border	GURDASPUR	11kV	DS S/D DIVN. BATALA	DS S/D DERA BABA NANAK	DBS9FL04	11 KV Kasowl	AMR	OK	31.03.2023		AP 3Phase 3Wire				254015	900-450/577/1-1	0,991	NA	Director/D	
B.684	Border	GURDASPUR	11kV	DS S/D DIVN. BATALA	DS S/D DERA BABA NANAK	DBS9FL02	11 KV Dala	AMR	OK	31.03.2023		AP 3Phase 3Wire				10283794	900-450/577/1-1	1,644	NA	Director/D	
B.685	Border	GURDASPUR	11kV	DS S/D DIVN. BATALA	DS S/D DERA BABA NANAK	DBS9FL07	NEW GHANEE KE BATE	NON AMR	OK	31.03.2023		AP 3Phase 3Wire				3197	900-450/577/1-1	1,676	NA	Director/D	
B.686	Border	GURDASPUR	11kV	DS S/D DIVN. BATALA	DS S/D DERA BABA NANAK	DBS9FL01	SHEHADA KLAN 24Hrs	AMR	OK	31.03.2023		Category 5-UPS				10282896	900-450/577/1-1	2,106	NA	Director/D	
B.687	Border	GURDASPUR	11kV	DS S/D DIVN. BATALA	DS S/D DERA BABA NANAK	DBS9FL05	11 KV SHEHADA SHEHRI	AMR	OK	31.03.2023		Category 1				2968	900-450/577/1-1	4,633	NA	Director/D	
B.688	Border	GURDASPUR	11kV	DS S/D DIVN. BATALA	DS S/D KOTLI SURAT MALHI	DBS3FL18	BASANT KOT	AMR	OK	31.03.2023		AP 3Phase 3Wire				73200527	1200/577/1-1	0,064	NA	Director/D	
B.689	Border	GURDASPUR	11kV	DS S/D DIVN. BATALA	DS S/D KOTLI SURAT MALHI	DBS3FL19	PARMESHER NAGER	AMR	OK	31.03.2023		AP 3Phase 3Wire				5683	1200/577/1-1	0,455	NA	Director/D	
B.690	Border	GURDASPUR	11kV	DS S/D DIVN. BATALA	DS S/D KOTLI SURAT MALHI	DBS3FL17	WARRACH	AMR	OK	31.03.2023		AP 3Phase 3Wire				73200499	1200/577/1-1	0,522	NA	Director/D	
B.691	Border	GURDASPUR	11kV	DS S/D DIVN. BATALA	DS S/D KOTLI SURAT MALHI	DBS3FL02	Dava Pathana	AMR	OK	31.03.2023		AP 3Phase 3Wire				2069245	400-200/5	1,927	NA	Director/D	
B.692	Border	GURDASPUR	11kV	DS S/D DIVN. BATALA	DS S/D KOTLI SURAT MALHI	DBS3FL05	Mirja Jan	AMR	OK	31.03.2023		AP 3Phase 3Wire				25089	400-200/5	0,943	NA	Director/D	
B.693	Border	GURDASPUR	11kV	DS S/D DIVN. BATALA	DS S/D KOTLI SURAT MALHI	DBS3FL03	Dargabadd	AMR	OK	31.03.2023		AP 3Phase 3Wire				205608	400-200/5	1,131	NA	Director/D	
B.694	Border	GURDASPUR	11kV	DS S/D DIVN. BATALA	DS S/D KOTLI SURAT MALHI	DBS3FL07	Gillan wali	AMR	OK	31.03.2023		AP 3Phase 3Wire				205915	400-200/5	1,461	NA	Director/D	
B.695	Border	GURDASPUR	11kV	DS S/D DIVN. BATALA	DS S/D KOTLI SURAT MALHI	DBS3FL15	DHILWAN	AMR	OK	31.03.2023		AP 3Phase 3Wire				2540626	1200/577/1-1	1,510	NA	Director/D	
B.696	Border	GURDASPUR	11kV	DS S/D DIVN. BATALA	DS S/D KOTLI SURAT MALHI	DBS3FL04	Sarwal	AMR	OK	31.03.2023		AP 3Phase 3Wire				2067535	1200/577/1-1	4,963	NA	Director/D	
B.697	Border	GURDASPUR	11kV	DS S/D DIVN. BATALA	DS S/D KOTLI SURAT MALHI	DBS3FL01	Chatha Sera	AMR	OK	31.03.2023		AP 3Phase 3Wire				2058	400-200/5	2,162	NA	Director/D	
B.698	Border	GURDASPUR	11kV	DS S/D DIVN. BATALA	DS S/D KOTLI SURAT MALHI	DBS3FL06	Dalam Dhaati	AMR	OK	31.03.2023		AP 3Phase 3Wire				2068275	1200/577/1-1	3,517	NA	Director/D	
B.699	Border	GURDASPUR	11kV	DS S/D DIVN. BATALA	DS S/D KOTLI SURAT MALHI	DBS3FL16	GHAZI NANGAL	AMR	OK	31.03.2023		Category 5-UPS				33484	1200/577/1-1	4,534	NA	Director/D	
B.700	Border	GURDASPUR	11kV	DS S/D DIVN. BATALA	DS S/D KOTLI SURAT MALHI	DBS3FL10	Mamman	AMR	OK	31.03.2023		Category 5-UPS				10288405	1200/577/1-1	5,782	NA	Director/D	
B.701	Border	GURDASPUR	11kV	DS S/D DIVN. BATALA	DS S/D KOTLI SURAT MALHI	DBS3FL08	Daulam 24 Hrs	AMR	OK	31.03.2023		Category 5-UPS				4221061	400-200/5	8,430	NA	Director/D	
B.702	Border	GURDASPUR	11kV	DS S/D DIVN. BATALA	DS S/D KOTLI SURAT MALHI	DBS3FL09	Dhanpur 24 Hrs	AMR	OK	31.03.2023		Category 5-UPS				2069245	400-200/5	10,177	NA	Director/D	
B.703	Border	GURDASPUR	11kV	DS S/D DIVN. BATALA	DS S/D KOTLI SURAT MALHI	DBS5FL11	Barkwal	AMR	OK	31.03.2023		AP 3Phase 3Wire				2067606	900-450/577/1-1	1,014	NA	Director/D	
B.704	Border	GURDASPUR	11kV	DS S/D DIVN. BATALA	DS S/D KOTLI SURAT MALHI	XDG0FL04	BILLWAL 24 Hrs	AMR	OK	31.03.2023		Category 5-UPS				1022540	1200-600/5	1,265	NA	Director/D	
B.705	Border	GURDASPUR	11kV	DS S/D DIVN. BATALA	DS S/D KOTLI SURAT MALHI	XDG0FL07	Akrapura	AMR	OK	31.03.2023		AP 3Phase 3Wire				2650	1200-600/5	1,570	NA	Director/D	
B.706	Border	GURDASPUR	11kV	DS S/D DIVN. BATALA	DS S/D KOTLI SURAT MALHI	XDG0FL01	DHAWAN	AMR	OK	31.03.2023		AP 3Phase 3Wire				216562	1200-600/5	1,677	NA	Director/D	
B.707	Border	GURDASPUR	11kV	DS S/D DIVN. BATALA	DS S/D KOTLI SURAT MALHI	XDG0FL03	SARWAL	AMR	OK	31.03.2023		AP 3Phase 3Wire				1028066	1200-600/5	1,866	NA	Director/D	
B.708	Border	GURDASPUR	11kV	DS S/D DIVN. BATALA	DS S/D KOTLI SURAT MALHI	XDG0FL02	DAMDODAR	AMR	OK	31.03.2023		AP 3Phase 3Wire				578952	1200-600/5	2,128	NA	Director/D	
B.709	Border	GURDASPUR	11kV	DS S/D DIVN. BATALA	DS S/D KOTLI SURAT MALHI	XDG0FL06	Bhagwal Khurd	AMR	OK	31.03.2023		Category 5-UPS				2718	1200-600/5	2,642	NA	Director/D	
B.710	Border	GURDASPUR	11kV	DS S/D DIVN. BATALA	DS S/D KOTLI SURAT MALHI	XDG0FL05	KOT MAILAS 24 Hrs	AMR	OK	31.03.2023		Category 5-UPS									

S.No	Zone	Circle	Voltage Level (kVA)	Division (kVA)	Sub-Division (kVA)	Feeder ID	Feeder Name	Feeder Metering Status (Metered/unmetered/AMR/AMI)	Status of Meter (Functional/Non-Functional)	Metering Date	Date of last actual meter reading/communication	Feeder Type (Agr/Industrial/Mixed)	Status of Communication			Period from 01.04.2021 to 31.03.2022				Sales	Remarks (Source of data)
													% data received through automatically if feeder AMR/AMI	Number of hours when meter was unable to communicate in overall	Total Number of hours in the period	Meter S.No	CT/PT ratio	Import (kWh)	Export (kWh)		
B.746	Border	GURDASPUR	11KV	DS S/U DIVN. BATALA	DS S/D NORTH S/D BATALA	DTG29FL03	11 KV Dharmkot Bagga	AMR	OK	31.03.2023		AP 3Phase 3Wire				4654	900-450/577/1-1-1	0.660	NA	Director/D	
B.747	Border	GURDASPUR	11KV	DS S/U DIVN. BATALA	DS S/D NORTH S/D BATALA	DTG29FL02	11 KV BACHO KA THEH	AMR	OK	31.03.2023		AP 3Phase 3Wire				4540	900-450/577/1-1-1	1.256	NA	Director/D	
B.748	Border	GURDASPUR	11KV	DS S/U DIVN. BATALA	DS S/D NORTH S/D BATALA	DTG29FL01	11 KV Hothiyan Sahib	AMR	OK	31.03.2023		Category 5-UPS				4316	900-450/577/1-1-1	3.303	NA	Director/D	
B.749	Border	GURDASPUR	11KV	DS S/U DIVN. BATALA	DS S/D NORTH S/D BATALA	DTG29FL04	Harde Thirade	AMR	OK	31.03.2023		AP 3Phase 3Wire				2657632	600/577/1-1-1	1.865	NA	Director/D	
B.750	Border	GURDASPUR	11KV	DS S/U DIVN. BATALA	DS S/D NORTH S/D BATALA	DTG29FL03	11 KV Said Mubarak	NON AMR	OK	31.03.2023		Category 5-UPS				240852	600/577/1-1-1	3.469	NA	Director/D	
B.751	Border	GURDASPUR	11KV	DS S/U DIVN. PATHANKOT	DS EAST S/D PATHANKOT	C859FL06	Mamoon	AMR	OK	31.03.2023		Category 1			440	900-450/577/1-1-1	14.354	NA	Director/D		
B.752	Border	GURDASPUR	11KV	DS S/U DIVN. PATHANKOT	DS EAST S/D PATHANKOT	C858FL20	s.shn ITr (132kV)	NON AMR	OK	31.03.2023		Category 1			129056	1200-600/5	0.044	NA	Director/D		
B.753	Border	GURDASPUR	11KV	DS S/U DIVN. PATHANKOT	DS EAST S/D PATHANKOT	C858FL14	Telephone Exchange	NON AMR	OK	31.03.2023		Category 4			2266529	1200-600/5	0.775	NA	Director/D		
B.754	Border	GURDASPUR	11KV	DS S/U DIVN. PATHANKOT	DS EAST S/D PATHANKOT	C858FL03	City Pk.	AMR	OK	31.03.2023		Category 1			2067272	1200-600/5	11.866	NA	Director/D		
B.755	Border	GURDASPUR	11KV	DS S/U DIVN. PATHANKOT	DS EAST S/D PATHANKOT	C858FL05	Prwet Nagar	AMR	OK	31.03.2023		Category 1			2056679	900-450/577/1-1-1	14.496	NA	Director/D		
B.756	Border	GURDASPUR	11KV	DS S/U DIVN. PATHANKOT	DS EAST S/D PATHANKOT	C858FL18	SALI ROAD	NON AMR	OK	31.03.2023		Category 1			2067408	900-450/577/1-1-1	15.141	NA	Director/D		
B.757	Border	GURDASPUR	11KV	DS S/U DIVN. PATHANKOT	DS EAST S/D PATHANKOT	E851FL02	MES	NON AMR	OK	31.03.2023		Category 4			487	400-200/5-5	0.000	NA	Director/D		
B.758	Border	GURDASPUR	11KV	DS S/U DIVN. PATHANKOT	DS EAST S/D PATHANKOT	E851FL03	Karoli	NON AMR	OK	31.03.2023		Category 4			2068785	400-200/5-5	4.239	NA	Director/D		
B.759	Border	GURDASPUR	11KV	DS S/U DIVN. PATHANKOT	DS EAST S/D PATHANKOT	E851FL01	Chakki	NON AMR	OK	31.03.2023		Kandi Mixed			388	200-100/5-5	13.112	NA	Director/D		
B.760	Border	GURDASPUR	11KV	DS S/U DIVN. PATHANKOT	DS EAST S/D PATHANKOT	D888FL05	Civil Hospital	AMR	OK	31.03.2023		Category 4			6669556	1200-600/5	0.095	NA	Director/D		
B.761	Border	GURDASPUR	11KV	DS S/U DIVN. PATHANKOT	DS EAST S/D PATHANKOT	D888FL09	VICTORIA ESTATE	NON AMR	OK	31.03.2023		Category 5-UPS			652225	1200-600/5	1.042	NA	Director/D		
B.762	Border	GURDASPUR	11KV	DS S/U DIVN. PATHANKOT	DS EAST S/D PATHANKOT	D888FL06	Manwal	AMR	OK	31.03.2023		Category 1			6669557	1200-600/5	1.508	NA	Director/D		
B.763	Border	GURDASPUR	11KV	DS S/U DIVN. PATHANKOT	DS EAST S/D PATHANKOT	D888FL07	NDK SEPARATE FEEDER	NON AMR	OK	31.03.2023		Category 1			33661	1200-600/5	1.558	NA	Director/D		
B.764	Border	GURDASPUR	11KV	DS S/U DIVN. PATHANKOT	DS EAST S/D PATHANKOT	D888FL04	Seunity	NON AMR	OK	31.03.2023		Kandi Mixed			2066837	1200-600/5	4.398	NA	Director/D		
B.765	Border	GURDASPUR	11KV	DS S/U DIVN. PATHANKOT	DS EAST S/D PATHANKOT	D888FL02	Lunni	NON AMR	OK	31.03.2023		Category 1			2066528	1200-600/5	5.473	NA	Director/D		
B.766	Border	GURDASPUR	11KV	DS S/U DIVN. PATHANKOT	DS EAST S/D PATHANKOT	D888FL11	CTTY 2	NON AMR	OK	31.03.2023		Category 1			5958	1200-600/5	6.996	NA	Director/D		
B.767	Border	GURDASPUR	11KV	DS S/U DIVN. PATHANKOT	DS EAST S/D PATHANKOT	D888FL01	Khanpur	Not available	OK	31.03.2023		Category 1			2067705	1200-600/5	10.936	NA	Director/D		
B.768	Border	GURDASPUR	11KV	DS S/U DIVN. PATHANKOT	DS EAST S/D PATHANKOT	C859C859	MES	NON AMR	OK	31.03.2023		Category 4			Not available	Not available	48.123	NA	Director/D		
B.769	Border	GURDASPUR	11KV	DS S/U DIVN. PATHANKOT	DS S/D DHAR	E853FL01	Sarti	AMR	OK	31.03.2023		Kandi Mixed			2068784	600/577/1-1-1	3.061	NA	Director/D		
B.770	Border	GURDASPUR	11KV	DS S/U DIVN. PATHANKOT	DS S/D DHAR	E853FL03	DUNERA	NON AMR	OK	31.03.2023		Kandi Mixed			564582	600/577/1-1-1	3.818	NA	Director/D		
B.771	Border	GURDASPUR	11KV	DS S/U DIVN. PATHANKOT	DS S/D DHAR	D888FL02	Basoli	NON AMR	OK	31.03.2023		Category 5-UPS			4179720	900-450/577/1-1-1	1.490	NA	Director/D		
B.772	Border	GURDASPUR	11KV	DS S/U DIVN. PATHANKOT	DS S/D DHAR	D888FL06	Bhatwan	NON AMR	OK	31.03.2023		Category 5-UPS			4179725	900-450/577/1-1-1	5.859	NA	Director/D		
B.773	Border	GURDASPUR	11KV	DS S/U DIVN. PATHANKOT	DS S/D DHAR	D888FL01	Sukret	NON AMR	OK	31.03.2023		Kandi Mixed			4179711	900-450/577/1-1-1	10.515	NA	Director/D		
B.774	Border	GURDASPUR	11KV	DS S/U DIVN. PATHANKOT	DS S/D DHAR	D888FL03	Meelema	NON AMR	OK	31.03.2023		AP 3Phase 3Wire			2067083	900-450/577/1-1-1	0.931	NA	Director/D		
B.775	Border	GURDASPUR	11KV	DS S/U DIVN. PATHANKOT	DS S/D DHAR	D888FL02	Jhaurli	NON AMR	OK	31.03.2023		AP 3Phase 3Wire			2067098	900-450/577/1-1-1	1.555	NA	Director/D		
B.776	Border	GURDASPUR	11KV	DS S/U DIVN. PATHANKOT	DS S/D DHAR	D888FL04	Gharoti	NON AMR	OK	31.03.2023		Category 1			4180057	900-450/577/1-1-1	2.266	NA	Director/D		
B.777	Border	GURDASPUR	11KV	DS S/U DIVN. PATHANKOT	DS S/D DHAR	D888FL07	11KV UPS BASSI	NON AMR	OK	31.03.2023		Category 5-UPS			1252785	900-450/577/1-1-1	5.697	NA	Director/D		
B.778	Border	GURDASPUR	11KV	DS S/U DIVN. PATHANKOT	DS S/D DHAR	D888FL06	Chouma	AMR	OK	31.03.2023		Category 5-UPS			5437705	900-450/577/1-1-1	9.691	NA	Director/D		
B.779	Border	GURDASPUR	11KV	DS S/U DIVN. PATHANKOT	DS S/D DHAR	D888FL05	Panjar	NON AMR	OK	31.03.2023		AP 3Phase 3Wire			2068049	1200/577/1-1-1	1.261	NA	Director/D		
B.780	Border	GURDASPUR	11KV	DS S/U DIVN. PATHANKOT	DS S/D DHAR	D888FL14	Solvek	AMR	OK	31.03.2023		Category 4			2068115	1200/577/1-1-1	1.768	NA	Director/D		
B.781	Border	GURDASPUR	11KV	DS S/U DIVN. PATHANKOT	DS S/D DHAR	D888FL10	Mallian	NON AMR	OK	31.03.2023		Category 5-UPS			2067009	1200/577/1-1-1	7.268	NA	Director/D		
B.782	Border	GURDASPUR	11KV	DS S/U DIVN. PATHANKOT	DS S/D DHAR	D888FL02	Palho Chack	NON AMR	OK	31.03.2023		AP 3Phase 3Wire			2336282	900-450/577/1-1-1	0.776	NA	Director/D		
B.783	Border	GURDASPUR	11KV	DS S/U DIVN. PATHANKOT	DS S/D DHAR	D888FL04	Habit Bindl	NON AMR	OK	31.03.2023		AP 3Phase 3Wire			7336695	900-450/577/1-1-1	1.303	NA	Director/D		
B.784	Border	GURDASPUR	11KV	DS S/U DIVN. PATHANKOT	DS S/D DHAR	D888FL02	Majra	NON AMR	OK	31.03.2023		Category 5-UPS			5342500	900-450/577/1-1-1	6.242	NA	Director/D		
B.785	Border	GURDASPUR	11KV	DS S/U DIVN. PATHANKOT	DS S/D DHAR	D888FL01	Ratangarh	NON AMR	OK	31.03.2023		Category 5-UPS			7336399	900-450/577/1-1-1	11.951	NA	Director/D		
B.786	Border	GURDASPUR	11KV	DS S/U DIVN. PATHANKOT	DS S/D DHAR	D888FL12	J.R. Agro	AMR	OK	31.03.2023		Category 4			5341641	900-450/5	0.000	NA	Director/D		
B.787	Border	GURDASPUR	11KV	DS S/U DIVN. PATHANKOT	DS S/D DHAR	D888FL18	Coco Cola (Wave Beverages)	NON AMR	OK	31.03.2023		Category 4			6017	900-450/5	0.258	NA	Director/D		
B.788	Border	GURDASPUR	11KV	DS S/U DIVN. PATHANKOT	DS S/D DHAR	D888FL10	Suar Mill	AMR	OK	31.03.2023		Category 1			1252785	900-450/5	6.290	NA	Director/D		
B.789	Border	GURDASPUR	11KV	DS S/U DIVN. PATHANKOT	DS S/D DHAR	D888FL09	Kanwan	AMR	OK	31.03.2023		AP 3Phase 3Wire			9140835	900-450/5	0.543	NA	Director/D		
B.790	Border	GURDASPUR	11KV	DS S/U DIVN. PATHANKOT	DS S/D DHAR	D888FL11	Ghesal	NON AMR	OK	31.03.2023		AP 3Phase 3Wire			8222681	900-450/5	0.616	NA	Director/D		
B.791	Border	GURDASPUR	11KV	DS S/U DIVN. PATHANKOT	DS S/D DHAR	D888FL13	Taragah	NON AMR	OK	31.03.2023		AP 3Phase 3Wire			8232312	900-450/5	0.818	NA	Director/D		
B.792	Border	GURDASPUR	11KV	DS S/U DIVN. PATHANKOT	DS S/D DHAR	D888FL15	CTTY-3	AMR	OK	31.03.2023		Category 2			7131010	900-450/5	1.424	NA	Director/D		
B.793	Border	GURDASPUR	11KV	DS S/U DIVN. PATHANKOT	DS S/D DHAR	D888FL06	Nawan Pind	NON AMR	OK	31.03.2023		AP 3Phase 3Wire			1366299	900-450/5	1.566	NA	Director/D		
B.794	Border	GURDASPUR	11KV	DS S/U DIVN. PATHANKOT	DS S/D DHAR	D888FL03	Daha	AMR	OK	31.03.2023		AP 3Phase 3Wire			37207	900-450/5	2.164	NA	Director/D		
B.795	Border	GURDASPUR	11KV	DS S/U DIVN. PATHANKOT	DS S/D DHAR	D888FL02	Saidpur	NON AMR	OK	31.03.2023		Category 5-UPS			37155	900-450/5	4.520	NA	Director/D		
B.796	Border	GURDASPUR	11KV	DS S/U DIVN. PATHANKOT	DS S/D DHAR	D888FL08	Manj	NON AMR	OK	31.03.2023		Category 5-UPS			2067447	900-450/5	4.558	NA	Director/D		
B.797	Border	GURDASPUR	11KV	DS S/U DIVN. PATHANKOT	DS S/D DHAR	D888FL01	City-1	NON AMR	OK	31.03.2023		Category 1			37124	900-450/5	5.554	NA	Director/D		
B.798	Border	GURDASPUR	11KV	DS S/U DIVN. PATHANKOT	DS S/D DHAR	D888FL14	CITY AWANKHA	AMR	OK	31.03.2023		Category 1			1209280	900-450/5	8.721	NA	Director/D		
B.799	Border	GURDASPUR	11KV	DS S/U DIVN. PATHANKOT	DS S/D DHAR	D888FL17	KORLA	AMR	OK	31.03.2023		Category 1			8223819	900-450/5	3.460	NA	Director/D		
B.800	Border	GURDASPUR	11KV	DS S/U DIVN. PATHANKOT	DS S/D DHAR	D888FL17	City Thana	AMR	OK	31.03.2023		Category 1			4561	900-450/5	9.657	NA	Director/D		
B.801	Border	GURDASPUR	11KV	DS S/U DIVN. PATHANKOT	DS S/D DHAR	D888FL05	Gurjan Lahri	NON AMR	OK	31.03.2023		Category 5-UPS			6669368	900-450/5	10.346	NA	Director/D		
B.802	Border	GURDASPUR	11KV	DS S/U DIVN. PATHANKOT	DS S/D DHAR	D888FL04	City-2	NON AMR	OK	31.03.2023		Category 1			37127	900-450/5	12.621	NA	Director/D		
B.803	Border	GURDASPUR	11KV	DS S/U DIVN. PATHANKOT	DS S/D DHAR	D888FL01	Bangpur	AMR	OK	31.03.2023		AP 3Phase 3Wire			2068645	900-450/577/1-1-1	0.523	NA	Director/D		
B.804	Border	GURDASPUR	11KV	DS S/U DIVN. PATHANKOT	DS S/D DHAR	DTG1FL0															

S.No	Zone	Circle	Voltage Level (kVA)	Division (kVA)	Sub-Division (kVA)	Feeder ID	Feeder Name	Feeder Metering Status (Metered/unmetered/AMR/AMI)	Status of Meter (Functional/Non-Functional)	Metering Date	Date of last actual meter reading/communication	Feeder Type (Agr/Industrial/Mixed)	Status of Communication			Period from 01.04.2021 to 31.03.2022				Sales	Remarks (Source of data)
													% data received through automatically if feeder AMR/AMI	Number of hours when meter was unable to communicate in overall	Total Number of hours in the period	Meter S.No	CT/PT ratio	Import (kWh)	Export (kWh)		
B.843	Border	SUB URBAN AMRITSAR	11KV	DS DIVN. JANDIALA GURU	S/D FATEHPUR RAJPUTAN	0820FL03	Matawal	AMR	OK	31.03.2023		AP 3Phase 3Wire				2067280	600/577/1-1-1	1.612		NA	Director/D
B.844	Border	SUB URBAN AMRITSAR	11KV	DS DIVN. JANDIALA GURU	S/D FATEHPUR RAJPUTAN	0820FL18	Akalanj Dhapian	AMR	OK	31.03.2023		AP 3Phase 3Wire				15196091	900-450/577/1-1-1	1.621		NA	Director/D
B.845	Border	SUB URBAN AMRITSAR	11KV	DS DIVN. JANDIALA GURU	S/D FATEHPUR RAJPUTAN	0820FL12	Dashmesh Nagar Canal	AMR	OK	31.03.2023		AP 3Phase 3Wire				4187906	900-450/577/1-1-1	1.859		NA	Director/D
B.846	Border	SUB URBAN AMRITSAR	11KV	DS DIVN. JANDIALA GURU	S/D FATEHPUR RAJPUTAN	0820FL14	Sardulwail	AMR	OK	31.03.2023		AP 3Phase 3Wire				2067280	600/577/1-1-1	1.927		NA	Director/D
B.847	Border	SUB URBAN AMRITSAR	11KV	DS DIVN. JANDIALA GURU	S/D FATEHPUR RAJPUTAN	0820FL06	Dashmesh Nagar	AMR	OK	31.03.2023		AP 3Phase 3Wire				8222928	600/577/1-1-1	2.138		NA	Director/D
B.848	Border	SUB URBAN AMRITSAR	11KV	DS DIVN. JANDIALA GURU	S/D FATEHPUR RAJPUTAN	0820FL09	Bhillowal	AMR	OK	31.03.2023		AP 3Phase 3Wire				2067390	600/577/1-1-1	2.221		NA	Director/D
B.849	Border	SUB URBAN AMRITSAR	11KV	DS DIVN. JANDIALA GURU	S/D FATEHPUR RAJPUTAN	0820FL01	Urban 1 Tarsika	AMR	OK	31.03.2023		Category 5-UPS				9534535	900-450/577/1-1-1	4.125		NA	Director/D
B.850	Border	SUB URBAN AMRITSAR	11KV	DS DIVN. JANDIALA GURU	S/D FATEHPUR RAJPUTAN	0820FL17	UPS-3 Panchar	NON AMR	OK	31.03.2023		Category 5-UPS				15196186	900-450/577/1-1-1	7.562		NA	Director/D
B.851	Border	SUB URBAN AMRITSAR	11KV	DS DIVN. JANDIALA GURU	S/D FATEHPUR RAJPUTAN	0820FL16	Tarsika Urban 2	NON AMR	OK	31.03.2023		Category 5-UPS				2067370	600/577/1-1-1	9.674		NA	Director/D
B.852	Border	SUB URBAN AMRITSAR	11KV	DS DIVN. JANDIALA GURU	S/D FATEHPUR RAJPUTAN	0823FL11	MIP (Model Industrial Park)	NON AMR	OK	31.03.2023		Category 1				5673	900-450/577/1-1-1	0.130		NA	Director/D
B.853	Border	SUB URBAN AMRITSAR	11KV	DS DIVN. JANDIALA GURU	S/D FATEHPUR RAJPUTAN	0823FL09	Impact Garden	NON AMR	OK	31.03.2023		Category 1				15196055	1200/577/1-1-1	1.030		NA	Director/D
B.854	Border	SUB URBAN AMRITSAR	11KV	DS DIVN. JANDIALA GURU	S/D FATEHPUR RAJPUTAN	0823FL07	Ashibary Homes	NON AMR	OK	31.03.2023		Category 1				13190560	1200/577/1-1-1	2.878		NA	Director/D
B.855	Border	SUB URBAN AMRITSAR	11KV	DS DIVN. JANDIALA GURU	S/D FATEHPUR RAJPUTAN	0823FL04	Khantok	NON AMR	OK	31.03.2023		Category 1				9534423	1200/577/1-1-1	7.081		NA	Director/D
B.856	Border	SUB URBAN AMRITSAR	11KV	DS DIVN. JANDIALA GURU	S/D FATEHPUR RAJPUTAN	0823FL01	SGRD Hospital	NON AMR	OK	31.03.2023		Category 4				23675	1200/577/1-1-1	7.122		NA	Director/D
B.857	Border	SUB URBAN AMRITSAR	11KV	DS DIVN. JANDIALA GURU	S/D FATEHPUR RAJPUTAN	0823FL02	Focal Point No.1	AMR	OK	31.03.2023		Category 2				9534516	1200/577/1-1-1	8.719		NA	Director/D
B.858	Border	SUB URBAN AMRITSAR	11KV	DS DIVN. JANDIALA GURU	S/D FATEHPUR RAJPUTAN	0823FL03	Focal point No3 Bhupindara	AMR	OK	31.03.2023		Category 2				9154223	900-450/577/1-1-1	19.425		NA	Director/D
B.859	Border	SUB URBAN AMRITSAR	11KV	DS DIVN. JANDIALA GURU	S/D FATEHPUR RAJPUTAN	0819FL03	Nawan Pind	AMR	OK	31.03.2023		AP 3Phase 3Wire				9140793	400-200/5-5	1.204		NA	Director/D
B.860	Border	SUB URBAN AMRITSAR	11KV	DS DIVN. JANDIALA GURU	S/D FATEHPUR RAJPUTAN	0819FL12	China	AMR	OK	31.03.2023		AP 3Phase 3Wire				8223073	900-450/577/1-1-1	1.296		NA	Director/D
B.861	Border	SUB URBAN AMRITSAR	11KV	DS DIVN. JANDIALA GURU	S/D FATEHPUR RAJPUTAN	0819FL16	Jogi Peer	AMR	OK	31.03.2023		AP 3Phase 3Wire				2888	400-200/5-5	1.373		NA	Director/D
B.862	Border	SUB URBAN AMRITSAR	11KV	DS DIVN. JANDIALA GURU	S/D FATEHPUR RAJPUTAN	0819FL07	Fairgaur	AMR	OK	31.03.2023		AP 3Phase 3Wire				2067516	900-450/577/1-1-1	1.533		NA	Director/D
B.863	Border	SUB URBAN AMRITSAR	11KV	DS DIVN. JANDIALA GURU	S/D FATEHPUR RAJPUTAN	0819FL11	Mearanchak	AMR	OK	31.03.2023		AP 3Phase 3Wire				9140792	900-450/577/1-1-1	1.573		NA	Director/D
B.864	Border	SUB URBAN AMRITSAR	11KV	DS DIVN. JANDIALA GURU	S/D FATEHPUR RAJPUTAN	0819FL17	Wakela Wala	AMR	OK	31.03.2023		AP 3Phase 3Wire				4979	400-200/5-5	1.578		NA	Director/D
B.865	Border	SUB URBAN AMRITSAR	11KV	DS DIVN. JANDIALA GURU	S/D FATEHPUR RAJPUTAN	0819FL18	Chhapa Ram Singh	AMR	OK	31.03.2023		AP 3Phase 3Wire				4812	400-200/5-5	1.633		NA	Director/D
B.866	Border	SUB URBAN AMRITSAR	11KV	DS DIVN. JANDIALA GURU	S/D FATEHPUR RAJPUTAN	0819FL09	Khalera	AMR	OK	31.03.2023		AP 3Phase 3Wire				8223684	900-450/577/1-1-1	1.633		NA	Director/D
B.867	Border	SUB URBAN AMRITSAR	11KV	DS DIVN. JANDIALA GURU	S/D FATEHPUR RAJPUTAN	0819FL15	Quilla Mehoka	AMR	OK	31.03.2023		AP 3Phase 3Wire				2067096	900-450/577/1-1-1	1.650		NA	Director/D
B.868	Border	SUB URBAN AMRITSAR	11KV	DS DIVN. JANDIALA GURU	S/D FATEHPUR RAJPUTAN	0819FL06	Maharawal	AMR	OK	31.03.2023		AP 3Phase 3Wire				2067124	900-450/577/1-1-1	1.763		NA	Director/D
B.869	Border	SUB URBAN AMRITSAR	11KV	DS DIVN. JANDIALA GURU	S/D FATEHPUR RAJPUTAN	0819FL08	Wadala Johal	AMR	OK	31.03.2023		AP 3Phase 3Wire				9140795	400-200/5-5	1.790		NA	Director/D
B.870	Border	SUB URBAN AMRITSAR	11KV	DS DIVN. JANDIALA GURU	S/D FATEHPUR RAJPUTAN	0819FL01	Khaazla	AMR	OK	31.03.2023		AP 3Phase 3Wire				9140794	400-200/5-5	1.883		NA	Director/D
B.871	Border	SUB URBAN AMRITSAR	11KV	DS DIVN. JANDIALA GURU	S/D FATEHPUR RAJPUTAN	0819FL13	Talwandi Dogra	AMR	OK	31.03.2023		AP 3Phase 3Wire				2067174	400-200/5-5	2.044		NA	Director/D
B.872	Border	SUB URBAN AMRITSAR	11KV	DS DIVN. JANDIALA GURU	S/D FATEHPUR RAJPUTAN	0819FL19	UPS-4 Makhawindi	AMR	OK	31.03.2023		Category 5-UPS				4981	400-200/5-5	4.637		NA	Director/D
B.873	Border	SUB URBAN AMRITSAR	11KV	DS DIVN. JANDIALA GURU	S/D FATEHPUR RAJPUTAN	0819FL14	Urban-3	AMR	OK	31.03.2023		Category 5-UPS				34228	900-450/577/1-1-1	9.489		NA	Director/D
B.874	Border	SUB URBAN AMRITSAR	11KV	DS DIVN. JANDIALA GURU	S/D FATEHPUR RAJPUTAN	0819FL04	Urban-1 Nwasajid	AMR	OK	31.03.2023		Category 5-UPS				2067865	900-450/577/1-1-1	11.564		NA	Director/D
B.875	Border	SUB URBAN AMRITSAR	11KV	DS DIVN. JANDIALA GURU	S/D FATEHPUR RAJPUTAN	0819FL10	Urban 2 Nwasajid	NON AMR	OK	31.03.2023		Category 5-UPS				10273778	400-200/5-5	11.896		NA	Director/D
B.876	Border	SUB URBAN AMRITSAR	11KV	DS DIVN. JANDIALA GURU	S/D JANDIALA GURU	0804FL17	Dharar AP Branch	NON AMR	OK	31.03.2023		AP 3Phase 3Wire				33486	900-450/577/1-1-1	0.111		NA	Director/D
B.877	Border	SUB URBAN AMRITSAR	11KV	DS DIVN. JANDIALA GURU	S/D JANDIALA GURU	0804FL20	Babe Sheedan Wala	AMR	OK	31.03.2023		AP 3Phase 3Wire				5249	1200/577/1-1-1	0.632		NA	Director/D
B.878	Border	SUB URBAN AMRITSAR	11KV	DS DIVN. JANDIALA GURU	S/D JANDIALA GURU	0804FL10	Rohi wala	AMR	OK	31.03.2023		AP 3Phase 3Wire				33486	900-450/577/1-1-1	1.454		NA	Director/D
B.879	Border	SUB URBAN AMRITSAR	11KV	DS DIVN. JANDIALA GURU	S/D JANDIALA GURU	0804FL16	Bhain Sidwan	AMR	OK	31.03.2023		AP 3Phase 3Wire				34037	900-450/577/1-1-1	1.595		NA	Director/D
B.880	Border	SUB URBAN AMRITSAR	11KV	DS DIVN. JANDIALA GURU	S/D JANDIALA GURU	0804FL04	jahangar	AMR	OK	31.03.2023		AP 3Phase 3Wire				7042914	1200/577/1-1-1	1.609		NA	Director/D
B.881	Border	SUB URBAN AMRITSAR	11KV	DS DIVN. JANDIALA GURU	S/D JANDIALA GURU	0804FL01	Karwal	AMR	OK	31.03.2023		AP 3Phase 3Wire				8222458	1200/577/1-1-1	1.845		NA	Director/D
B.882	Border	SUB URBAN AMRITSAR	11KV	DS DIVN. JANDIALA GURU	S/D JANDIALA GURU	0804FL02	Timawal	AMR	OK	31.03.2023		AP 3Phase 3Wire				2066819	1200/577/1-1-1	2.086		NA	Director/D
B.883	Border	SUB URBAN AMRITSAR	11KV	DS DIVN. JANDIALA GURU	S/D JANDIALA GURU	0804FL18	Ekalgada Category-1	AMR	OK	31.03.2023		Category 1				4331	900-450/577/1-1-1	3.807		NA	Director/D
B.884	Border	SUB URBAN AMRITSAR	11KV	DS DIVN. JANDIALA GURU	S/D JANDIALA GURU	0804FL06	Urban Ekalgada	NON AMR	OK	31.03.2023		Category 5-UPS				2068004	1200/577/1-1-1	8.491		NA	Director/D
B.885	Border	SUB URBAN AMRITSAR	11KV	DS DIVN. JANDIALA GURU	S/D JANDIALA GURU	0808FL12	Bhanganw AP Branch	NON AMR	OK	31.03.2023		AP 3Phase 3Wire				5275	900-450/577/1-1-1	1.436		NA	Director/D
B.886	Border	SUB URBAN AMRITSAR	11KV	DS DIVN. JANDIALA GURU	S/D JANDIALA GURU	0808FL06	Gunawall	AMR	OK	31.03.2023		AP 3Phase 3Wire				5251	900-450/577/1-1-1	1.501		NA	Director/D
B.887	Border	SUB URBAN AMRITSAR	11KV	DS DIVN. JANDIALA GURU	S/D JANDIALA GURU	0808FL08	Ekalgada	AMR	OK	31.03.2023		AP 3Phase 3Wire				8222847	900-450/577/1-1-1	1.737		NA	Director/D
B.888	Border	SUB URBAN AMRITSAR	11KV	DS DIVN. JANDIALA GURU	S/D JANDIALA GURU	0808FL02	Gadli	NON AMR	OK	31.03.2023		AP 3Phase 3Wire				5463645	1200/577/1-1-1	1.883		NA	Director/D
B.889	Border	SUB URBAN AMRITSAR	11KV	DS DIVN. JANDIALA GURU	S/D JANDIALA GURU	0808FL03	Dew Dass pura	NON AMR	OK	31.03.2023		AP 3Phase 3Wire				2067027	1200/577/1-1-1	2.216		NA	Director/D
B.890	Border	SUB URBAN AMRITSAR	11KV	DS DIVN. JANDIALA GURU	S/D JANDIALA GURU	0808FL15	Palas	AMR	OK	31.03.2023		Category 1				4539	900-450/577/1-1-1	4.846		NA	Director/D
B.891	Border	SUB URBAN AMRITSAR	11KV	DS DIVN. JANDIALA GURU	S/D JANDIALA GURU	0808FL13	City-3	AMR	OK	31.03.2023		Category 1				8223559	1200/577/1-1-1	9.179		NA	Director/D
B.892	Border	SUB URBAN AMRITSAR	11KV	DS DIVN. JANDIALA GURU	S/D JANDIALA GURU	0808FL11	City 1	AMR	OK	31.03.2023		Category 1				6740780	900-450/577/1-1-1	10.672		NA	Director/D
B.893	Border	SUB URBAN AMRITSAR	11KV	DS DIVN. JANDIALA GURU	S/D JANDIALA GURU	0808FL04	Gehri	AMR	OK	31.03.2023		Category 1				7042882	1200/577/1-1-1	11.632		NA	Director/D
B.894	Border	SUB URBAN AMRITSAR	11KV	DS DIVN. JANDIALA GURU	S/D JANDIALA GURU	0808FL09	Urban Jandiala	NON AMR	OK	31.03.2023		Category 5-UPS				6669555	900-450/577/1-1-1	13.303		NA	Director/D
B.895	Border	SUB URBAN AMRITSAR	11KV	DS DIVN. JANDIALA GURU	S/D JANDIALA GURU	0808FL01	City 2	NON AMR	OK	31.03.2023		Category 1				5437690	1200/577/1-1-1	13.963		NA	Director/D
B.896	Border	SUB URBAN AMRITSAR	11KV	DS DIVN. JANDIALA GURU	S/D JANDIALA GURU	0821FL11	Jhain Singh Wala	NON AMR	OK	31.03.2023		AP 3Phase 3Wire				20671821	900-450/577/1-1-1	1.115		NA	Director/D
B.897	Border	SUB URBAN AMRITSAR	11KV	DS DIVN. JANDIALA GURU	S/D JANDIALA GURU	0821FL06	Wadali	AMR	OK	31.03.2023		AP 3Phase 3Wire				2067275	900-450/577/1-1-1	1.533		NA	Director/D
B.898	Border	SUB URBAN AMRITSAR	11KV	DS DIVN. JANDIALA GURU	S/D JANDIALA GURU	0821FL10	Rajewal	AMR	OK	31.03.2023		AP 3Phase 3Wire				2067508	900-450/577/1-1-1	1.836		NA	Director/D
B.899	Border	SUB URBAN AMRITSAR	11KV	DS DIVN. JANDIALA GURU	S/D JANDIALA GURU	0821FL03	Meharbanpura	AMR	OK	31.03.2023		AP 3Phase 3Wire				11116851	900-450/577/1-1-1	2.209		NA	Director/D
B.900	Border	SUB URBAN AMRITSAR	11KV	DS DIVN. JANDIALA GURU	S/D JANDIALA GURU	0821FL16	Dream City Ambuja	NON AMR	OK	31.03.2023		Category 1				33646	900-450/577/1-1-1	3.222		NA	Director/D
B.901	Border	SUB URBAN AMRITSAR	11KV	DS DIVN. JANDIALA GURU	S/D JANDIALA GURU	0821FL09	Bhai Bhan	AMR	OK												

S.No	Zone	Circle	Voltage Level (kVA)	Division (kVA)	Sub-Division (kVA)	Feeder ID	Feeder Name	Feeder Metering Status (Metered/unmetered/AMR/AMI)	Status of Meter (Functional/Non-Functional)	Metering Date	Date of last actual meter reading/communication	Feeder Type (Agr/Industrial/Mixed)	Status of Communication			Period from 01.04.2021 to 31.03.2022				Sales	Remarks (Source of data)
													% data received through automatically by feeder AMR/AMI	Number of hours when meter was unable to communicate in overall	Total Number of hours in the period	Meter S.No	CT/PT ratio	Import (kWh)	Export (kWh)		
B.940	Border	SUB URBAN AMRITSAR	11KV	DS DIVN. JANDIALA GURU	DS S/D TANGRA	C805FL18	UPS Chhajalwadi	NON AMR	OK	31.03.2023		Category 5-UPS				4688	900-450/577/1-1-1	9.832	NA	Director/D	
B.941	Border	SUB URBAN AMRITSAR	11KV	DS DIVN. JANDIALA GURU	DS S/D TANGRA	C805FL02	Urban Tangra	NON AMR	OK	31.03.2023		Category 5-UPS				2067924	900-450/577/1-1-1	11.039	NA	Director/D	
B.942	Border	SUB URBAN AMRITSAR	11KV	DS DIVN. JANDIALA GURU	DS S/D TANGRA	C805FL01	Kotlia Urban	AMR	OK	31.03.2023		Category 5-UPS				2067920	1200/577/1-1-1	11.362	NA	Director/D	
B.943	Border	SUB URBAN AMRITSAR	11KV	DS DIVN. JANDIALA GURU	DS S/D TANGRA	C805FL15	Rasulpur	AMR	OK	31.03.2023		Category 5-UPS				1287615	900-450/577/1-1-1	1.275	NA	Director/D	
B.944	Border	SUB URBAN AMRITSAR	11KV	DS DIVN. JANDIALA GURU	DS S/D TANGRA	D820FL07	Kaikhra	AMR	OK	31.03.2023		Category 1				9140689	600/577/1-1-1	1.541	NA	Director/D	
B.945	Border	SUB URBAN AMRITSAR	11KV	DS DIVN. JANDIALA GURU	DS S/D TANGRA	D820FL11	Malowal 2	AMR	OK	31.03.2023		Category 1				8222930	900-450/577/1-1-1	1.618	NA	Director/D	
B.946	Border	SUB URBAN AMRITSAR	11KV	DS DIVN. JANDIALA GURU	DS S/D TANGRA	D820FL19	UPS Kot Khera	NON AMR	OK	31.03.2023		Category 5-UPS				4510	600/577/1-1-1	4.016	NA	Director/D	
B.947	Border	SUB URBAN AMRITSAR	11KV	DS EAST DIVN.	DS GOPAL NAGAR S/D	C806FL01	POWER COLONY	AMR	OK	31.03.2023		Category 1				12093585	1200/577/1-1-1	0.347	NA	Director/D	
B.948	Border	SUB URBAN AMRITSAR	11KV	DS EAST DIVN.	DS GOPAL NAGAR S/D	C806FL13	VEER GARDEN	NON AMR	OK	31.03.2023		Category 1				33844	1200/577/1-1-1	1.733	NA	Director/D	
B.949	Border	SUB URBAN AMRITSAR	11KV	DS EAST DIVN.	DS GOPAL NAGAR S/D	R806F8	Hari mandir	NON AMR	OK	31.03.2023		Category 1				9544704	1200/577/1-1-1	5.638	NA	Director/D	
B.950	Border	SUB URBAN AMRITSAR	11KV	DS EAST DIVN.	DS GOPAL NAGAR S/D	C806FL02	GOPAL NAGAR	AMR	OK	31.03.2023		Category 1				2066717	Not installed	5.667	NA	Director/D	
B.951	Border	SUB URBAN AMRITSAR	11KV	DS EAST DIVN.	DS GOPAL NAGAR S/D	C806FL12	BABA SHRI CHAND AVNUE	NON AMR	OK	31.03.2023		Category 1				33850	1200/577/1-1-1	5.878	NA	Director/D	
B.952	Border	SUB URBAN AMRITSAR	11KV	DS EAST DIVN.	DS GOPAL NAGAR S/D	C806FL03	GOKAL NAGAR	NON AMR	OK	31.03.2023		Category 1				202046993	Not installed	9.565	NA	Director/D	
B.953	Border	SUB URBAN AMRITSAR	11KV	DS EAST DIVN.	DS GOPAL NAGAR S/D	C806FL09	silverstare	NON AMR	OK	31.03.2023		Category 1				5343350	Not installed	12.641	NA	Director/D	
B.954	Border	SUB URBAN AMRITSAR	11KV	DS EAST DIVN.	DS GOPAL NAGAR S/D	C806FL05	DIAMOND AVENUE	NON AMR	OK	31.03.2023		Category 1				7035651	Not installed	13.254	NA	Director/D	
B.955	Border	SUB URBAN AMRITSAR	11KV	DS EAST DIVN.	DS GOPAL NAGAR S/D	C806FL08	M.E.S	NON AMR	OK	31.03.2023		Category 1				10273775	1200/577/1-1-1	17.043	NA	Director/D	
B.956	Border	SUB URBAN AMRITSAR	11KV	DS EAST DIVN.	DS GOPAL NAGAR S/D	C806FL10	SG enclave	NON AMR	OK	31.03.2023		Category 1				23146	1200/577/1-1-1	17.671	NA	Director/D	
B.957	Border	SUB URBAN AMRITSAR	11KV	DS EAST DIVN.	DS GOPAL NAGAR S/D	C806FL05	MAUITHA ROAD VERKA BYE PASS	AMR	OK	31.03.2023		Category 1				7042843	Not installed	19.529	NA	Director/D	
B.958	Border	SUB URBAN AMRITSAR	11KV	DS EAST DIVN.	DS GOPAL NAGAR S/D	C802FL13	Jagatambey Colony	AMR	OK	31.03.2023		Category 1				5388127	1200-600/5	9.468	NA	Director/D	
B.959	Border	SUB URBAN AMRITSAR	11KV	DS EAST DIVN.	DS GOPAL NAGAR S/D	C802FL03	NEHRU COLONY	AMR	OK	31.03.2023		Category 1				11117105	1200-600/5	9.611	NA	Director/D	
B.960	Border	SUB URBAN AMRITSAR	11KV	DS EAST DIVN.	DS GOPAL NAGAR S/D	C802FL09	MAUITHA ROAD	AMR	OK	31.03.2023		Category 1				7032020	1200-600/5	19.925	NA	Director/D	
B.961	Border	SUB URBAN AMRITSAR	11KV	DS EAST DIVN.	DS GOPAL NAGAR S/D	8801FL03	MAUITHA ROAD BYE PASS	AMR	OK	31.03.2023		Category 1				2066653	1200/577/1-1-1	11.925	NA	Director/D	
B.962	Border	SUB URBAN AMRITSAR	11KV	DS EAST DIVN.	DS GOPAL NAGAR S/D	8801FL05	KARAM PURA	AMR	OK	31.03.2023		Category 1				8222900	1200/577/1-1-1	19.531	NA	Director/D	
B.963	Border	SUB URBAN AMRITSAR	11KV	DS EAST DIVN.	DS GOPAL NAGAR S/D	D844FL06	11kv Gopal Mandir	AMR	OK	31.03.2023		Category 1				526431	1200/577/1-1-1	6.025	NA	Director/D	
B.964	Border	SUB URBAN AMRITSAR	11KV	DS EAST DIVN.	DS GOPAL NAGAR S/D	D844FL02	GHATA MALA CHOWNK	AMR	OK	31.03.2023		Category 1				526424	1200/577/1-1-1	7.351	NA	Director/D	
B.965	Border	SUB URBAN AMRITSAR	11KV	DS EAST DIVN.	DS GOPAL NAGAR S/D	C806FL11	Avtar Avenue	Not available	OK	31.03.2023		Category 1				5264227	1200/577/1-1-1	9.782	NA	Director/D	
B.966	Border	SUB URBAN AMRITSAR	12KV	DS EAST DIVN.	DS GOPAL NAGAR S/D	80186	Khanna paper mill	AMR	OK	31.03.2023		Category 1				Not available	Not available	64.764	NA	Director/D	
B.967	Border	SUB URBAN AMRITSAR	11KV	DS EAST DIVN.	DS GOPAL NAGAR S/D	8801FL13	Trillium	AMR	OK	31.03.2023		Category 1				11117070	1200/577/1-1-1	6.524	NA	Director/D	
B.968	Border	SUB URBAN AMRITSAR	11KV	DS EAST DIVN.	DS GOPAL NAGAR S/D	D801FL04	MEDICAL ENCLAVE	AMR	OK	31.03.2023		Category 1				2047067	1200/577/1-1-1	10.991	NA	Director/D	
B.969	Border	SUB URBAN AMRITSAR	11KV	DS EAST DIVN.	DS GOPAL NAGAR S/D	8801FL17	Faizpur	AMR	OK	31.03.2023		Category 1				583677	1200/577/1-1-1	17.574	NA	Director/D	
B.970	Border	SUB URBAN AMRITSAR	11KV	DS EAST DIVN.	DS S/D CHHEHARTA	C803FL02	MES-2	AMR	OK	31.03.2023		Category 1				2993736	900-450/577/1-1-1	0.000	NA	Director/D	
B.971	Border	SUB URBAN AMRITSAR	11KV	DS EAST DIVN.	DS S/D CHHEHARTA	C803FL16	S-STM	AMR	OK	31.03.2023		Category 2				2091464	900-450/577/1-1-1	0.577	NA	Director/D	
B.972	Border	SUB URBAN AMRITSAR	11KV	DS EAST DIVN.	DS S/D CHHEHARTA	C803FL15	BST HEAD QUATER	AMR	OK	31.03.2023		Category 1				5484	1200/577/1-1-1	2.639	NA	Director/D	
B.973	Border	SUB URBAN AMRITSAR	11KV	DS EAST DIVN.	DS S/D CHHEHARTA	C803FL01	Boparai	AMR	OK	31.03.2023		Category 1				6740744	900-450/577/1-1-1	5.135	NA	Director/D	
B.974	Border	SUB URBAN AMRITSAR	11KV	DS EAST DIVN.	DS S/D CHHEHARTA	C803FL03	HAMIDPURA	AMR	OK	31.03.2023		Category 1				583774	900-450/577/1-1-1	9.505	NA	Director/D	
B.975	Border	SUB URBAN AMRITSAR	11KV	DS EAST DIVN.	DS S/D CHHEHARTA	C803FL11	Manabir	AMR	OK	31.03.2023		Category 1				7042897	1200/577/1-1-1	14.749	NA	Director/D	
B.976	Border	SUB URBAN AMRITSAR	11KV	DS EAST DIVN.	DS S/D CHHEHARTA	C803FL10	CHHEHARTA	AMR	OK	31.03.2023		Category 1				2067652	1200-600/5	15.518	NA	Director/D	
B.977	Border	SUB URBAN AMRITSAR	11KV	DS EAST DIVN.	DS S/D CHHEHARTA	C803FL04	MIRI PURI	Not available	OK	31.03.2023		Category 1				6761921	900-450/577/1-1-1	21.243	NA	Director/D	
B.978	Border	SUB URBAN AMRITSAR	66KV	DS EAST DIVN.	DS S/D CHHEHARTA	D803D02	MES(BS-377)PT	AMR	OK	31.03.2023		Category 2				Not available	Not available	15.704	NA	Director/D	
B.979	Border	SUB URBAN AMRITSAR	11KV	DS EAST DIVN.	DS S/D CHHEHARTA	8813FL15	Bhalla Colony	AMR	OK	31.03.2023		Category 1				583761	1200-600/5	8.000	NA	Director/D	
B.980	Border	SUB URBAN AMRITSAR	11KV	DS EAST DIVN.	DS S/D CHHEHARTA	D813FL14	SANDHU COLONY	AMR	OK	31.03.2023		Category 1				2066290	1200-600/5	8.848	NA	Director/D	
B.981	Border	SUB URBAN AMRITSAR	11KV	DS EAST DIVN.	DS S/D CHHEHARTA	D813FL05	Partap Bazar	AMR	OK	31.03.2023		Category 1				2067935	1200-600/5	9.728	NA	Director/D	
B.982	Border	SUB URBAN AMRITSAR	11KV	DS EAST DIVN.	DS S/D East Commercial	C802FL15	ESCORT HOSPITAL	AMR	OK	31.03.2023		Category 1				2046426	1200/577/1-1-1	9.477	NA	Director/D	
B.983	Border	SUB URBAN AMRITSAR	11KV	DS EAST DIVN.	DS S/D East Commercial	C802FL12	MULK PLANT	AMR	OK	31.03.2023		Category 2				5341646	1200-600/5	16.664	NA	Director/D	
B.984	Border	SUB URBAN AMRITSAR	11KV	DS EAST DIVN.	DS S/D East Commercial	C802FL16	A.S.FARM	AMR	OK	31.03.2023		Category 2				7042889	1200-600/5	15.819	NA	Director/D	
B.985	Border	SUB URBAN AMRITSAR	11KV	DS EAST DIVN.	DS S/D East Commercial	D804FL02	VERKA IND. 2	AMR	OK	31.03.2023		Category 1				12093474	900-450/577/1-1-1	7.787	NA	Director/D	
B.986	Border	SUB URBAN AMRITSAR	11KV	DS EAST DIVN.	DS S/D East Commercial	D804FL01	VERKA IND. 2	AMR	OK	31.03.2023		Category 1				6679941	900-450/577/1-1-1	10.493	NA	Director/D	
B.987	Border	SUB URBAN AMRITSAR	11KV	DS EAST DIVN.	DS S/D East Commercial	D804FL10	GURU DINDRA NANKSAR	AMR	OK	31.03.2023		Category 1				1206465	1200-600/5	18.164	NA	Director/D	
B.988	Border	SUB URBAN AMRITSAR	11KV	DS EAST DIVN.	DS S/D East Commercial	D806FL02	GURU NAGAR	AMR	OK	31.03.2023		Category 1				33689	1200/577/1-1-1	22.471	NA	Director/D	
B.989	Border	SUB URBAN AMRITSAR	11KV	DS EAST DIVN.	DS S/D East Commercial	F1060832	BYE PASS VERKA	AMR	OK	31.03.2023		Category 1				9154242	900-450/577/1-1-1	6.116	NA	Director/D	
B.990	Border	SUB URBAN AMRITSAR	11KV	DS EAST DIVN.	DS S/D EAST TECH(East-Verka)	C802FL07	VERKA COLONY	AMR	OK	31.03.2023		Category 1				2068864	1200-600/5	0.212	NA	Director/D	
B.991	Border	SUB URBAN AMRITSAR	11KV	DS EAST DIVN.	DS S/D EAST TECH(East-Verka)	C802FL10	TRW-1	AMR	OK	31.03.2023		Category 1				6754317	1200-600/5	6.345	NA	Director/D	
B.992	Border	SUB URBAN AMRITSAR	11KV	DS EAST DIVN.	DS S/D EAST TECH(East-Verka)	C802FL18	Bankie bhairi	AMR	OK	31.03.2023		Category 1				1545	1200-600/5	7.039	NA	Director/D	
B.993	Border	SUB URBAN AMRITSAR	11KV	DS EAST DIVN.	DS S/D EAST TECH(East-Verka)	C802FL17	BANSHIRI AVNUE	AMR	OK	31.03.2023		Category 1				2067212	1200-600/5	8.853	NA	Director/D	
B.994	Border	SUB URBAN AMRITSAR	11KV	DS EAST DIVN.	DS S/D EAST TECH(East-Verka)	C802FL19	Mustafababad	AMR	OK	31.03.2023		Category 1				4049	1200-600/5	10.706	NA	Director/D	
B.995	Border	SUB URBAN AMRITSAR	11KV	DS EAST DIVN.	DS S/D EAST TECH(East-Verka)	C802FL17	Judge Nagar	AMR	OK	31.03.2023		Category 1				7336386	1200-600/5	13.089	NA	Director/D	
B.996	Border	SUB URBAN AMRITSAR	11KV	DS EAST DIVN.	DS S/D EAST TECH(East-Verka)	C802FL11	BATALA ROAD	AMR	OK	31.03.2023		Category 1				30299	1200-				

S.No	Zone	Circle	Voltage Level (kVA)	Division (kVA)	Sub-Division (kVA)	Feeder ID	Feeder Name	Feeder Metering Status (Metered/unmetered/AMR/AM)	Status of Meter (Functional/Non-Functional)	Metering Date (Date of last actual meter reading/communication)	Feeder Type (Agr/Industrial/Mixed)	Status of Communication			Period from 01.04.2021 to 31.03.2022				Sales	Remarks (Source of data)
												% data received through automatically if feeder AMR/AM	Number of hours when meter was unable to communicate in overall	Total Number of hours in the period	Meter S.No	CT/PT ratio	Import (kWh)	Export (kWh)		
B.1037	Border	SUB URBAN AMRITSAR	11KV	DS EAST DIVN.	DS SOUTH S/D	0801F06	HOUSING BOARD COLONY	AMR	OK	31.03.2023	Category 1				2068007	1200/577/1-1-1	7.972	NA	Director/D	
B.1038	Border	SUB URBAN AMRITSAR	11KV	DS EAST DIVN.	DS SOUTH S/D	0801F18	Mallian Wall	AMR	OK	31.03.2023	Category 1				16199283	1200/577/1-1-1	9.010	NA	Director/D	
B.1039	Border	SUB URBAN AMRITSAR	11KV	DS EAST DIVN.	DS SOUTH S/D	0801F03	RANIT AVENUE	AMR	OK	31.03.2023	Category 1				7035624	1200/577/1-1-1	9.019	NA	Director/D	
B.1040	Border	SUB URBAN AMRITSAR	11KV	DS EAST DIVN.	DS SOUTH S/D	0801F14	Phiraj Avenue B block	AMR	OK	31.03.2023	Category 1				30034	1200/577/1-1-1	10.389	NA	Director/D	
B.1041	Border	SUB URBAN AMRITSAR	11KV	DS EAST DIVN.	DS SOUTH S/D	0801F11	SEC-4 BANIT AVENUE	AMR	OK	31.03.2023	Category 1				2068588	1200/577/1-1-1	12.090	NA	Director/D	
B.1042	Border	SUB URBAN AMRITSAR	11KV	DS EAST DIVN.	DS SOUTH S/D	0801F16	11 KV PASSPORT OFFICE	AMR	OK	31.03.2023	Category 1				583729	1200/577/1-1-1	13.237	NA	Director/D	
B.1043	Border	SUB URBAN AMRITSAR	11KV	DS EAST DIVN.	DS SOUTH S/D	0801F10	GUMTALA	AMR	OK	31.03.2023	Category 1				2066730	1200/577/1-1-1	14.871	NA	Director/D	
B.1044	Border	SUB URBAN AMRITSAR	11KV	DS S/U DIVN. AMRITSAR	DS S/D HARSHA CHINNA	0801F08	LOHARAKA AP	AMR	OK	31.03.2023	AP 3Phase 3Wire				7336541	1200/577/1-1-1	1.850	NA	Director/D	
B.1045	Border	SUB URBAN AMRITSAR	11KV	DS S/U DIVN. AMRITSAR	DS S/D HARSHA CHINNA	8801F15	WADHA MEERANKOT	AMR	OK	31.03.2023	AP 3Phase 3Wire				8740908	1200/577/1-1-1	2.389	NA	Director/D	
B.1046	Border	SUB URBAN AMRITSAR	11KV	DS S/U DIVN. AMRITSAR	DS S/D HARSHA CHINNA	8801F16	LDHARKA UPS	NON AMR	OK	31.03.2023	Category 5 UPS				7336609	1200/577/1-1-1	10.555	NA	Director/D	
B.1047	Border	SUB URBAN AMRITSAR	11KV	DS S/U DIVN. AMRITSAR	DS S/D HARSHA CHINNA	0839F11	BABA BOOR SINGH AP	NON AMR	OK	31.03.2023	AP 3Phase 3Wire				4151	900-450/577/1-1-1	0.094	NA	Director/D	
B.1048	Border	SUB URBAN AMRITSAR	11KV	DS S/U DIVN. AMRITSAR	DS S/D HARSHA CHINNA	0839F06	MALLU NANGAL AP	NON AMR	OK	31.03.2023	AP 3Phase 3Wire				1596079	900-450/577/1-1-1	0.984	NA	Director/D	
B.1049	Border	SUB URBAN AMRITSAR	11KV	DS S/U DIVN. AMRITSAR	DS S/D HARSHA CHINNA	0839F03	LOHARAKA AP	NON AMR	OK	31.03.2023	AP 3Phase 3Wire				94344	900-450/577/1-1-1	1.346	NA	Director/D	
B.1050	Border	SUB URBAN AMRITSAR	11KV	DS S/U DIVN. AMRITSAR	DS S/D HARSHA CHINNA	0839F06	JAGDEY KALAN AP	NON AMR	OK	31.03.2023	AP 3Phase 3Wire				44935	900-450/577/1-1-1	2.479	NA	Director/D	
B.1051	Border	SUB URBAN AMRITSAR	11KV	DS S/U DIVN. AMRITSAR	DS S/D HARSHA CHINNA	0839F01	JAGDEY KALAN CAT-1	AMR	OK	31.03.2023	Category 1				15198507	900-450/577/1-1-1	6.698	NA	Director/D	
B.1052	Border	SUB URBAN AMRITSAR	11KV	DS S/U DIVN. AMRITSAR	DS S/D HARSHA CHINNA	0820F12	MALLUNANGAL	AMR	OK	31.03.2023	AP 3Phase 3Wire				10273786	1200-600/5	0.000	NA	Director/D	
B.1053	Border	SUB URBAN AMRITSAR	11KV	DS S/U DIVN. AMRITSAR	DS S/D HARSHA CHINNA	0820F02	SADOPURA	AMR	OK	31.03.2023	AP 3Phase 3Wire				2067115	1200-600/5	0.805	NA	Director/D	
B.1054	Border	SUB URBAN AMRITSAR	11KV	DS S/U DIVN. AMRITSAR	DS S/D HARSHA CHINNA	0820F09	ADLIWAL/HIC	AMR	OK	31.03.2023	AP 3Phase 3Wire				2067113	1200-600/5	1.039	NA	Director/D	
B.1055	Border	SUB URBAN AMRITSAR	11KV	DS S/U DIVN. AMRITSAR	DS S/D HARSHA CHINNA	0820F14	DHARWAL	AMR	OK	31.03.2023	AP 3Phase 3Wire				23749	1200-600/5	2.012	NA	Director/D	
B.1056	Border	SUB URBAN AMRITSAR	11KV	DS S/U DIVN. AMRITSAR	DS S/D HARSHA CHINNA	0820F15	BEH WALA	AMR	OK	31.03.2023	AP 3Phase 3Wire				15198109	1200-600/5	2.124	NA	Director/D	
B.1057	Border	SUB URBAN AMRITSAR	11KV	DS S/U DIVN. AMRITSAR	DS S/D HARSHA CHINNA	0820F08	HARSHA CHINNA AP	AMR	OK	31.03.2023	AP 3Phase 3Wire				6675528	1200-600/5	2.335	NA	Director/D	
B.1058	Border	SUB URBAN AMRITSAR	11KV	DS S/U DIVN. AMRITSAR	DS S/D HARSHA CHINNA	0820F16	Amir Chand Exports	AMR	OK	31.03.2023	Category 2				10282933	1200-600/5	2.568	NA	Director/D	
B.1059	Border	SUB URBAN AMRITSAR	11KV	DS S/U DIVN. AMRITSAR	DS S/D HARSHA CHINNA	0820F06	GURU KA BAGH	AMR	OK	31.03.2023	AP 3Phase 3Wire				2067260	1200-600/5	3.017	NA	Director/D	
B.1060	Border	SUB URBAN AMRITSAR	11KV	DS S/U DIVN. AMRITSAR	DS S/D HARSHA CHINNA	0820F04	RAJASANSI/HIC	AMR	OK	31.03.2023	Category 1				2067520	1200-600/5	11.119	NA	Director/D	
B.1061	Border	SUB URBAN AMRITSAR	11KV	DS S/U DIVN. AMRITSAR	DS S/D HARSHA CHINNA	0820F11	HARSHA CHINNA UPS	AMR	OK	31.03.2023	Category 5-UPS				2067110	1200-600/5	13.618	NA	Director/D	
B.1062	Border	SUB URBAN AMRITSAR	11KV	DS S/U DIVN. AMRITSAR	DS S/D HARSHA CHINNA	0820F14	JAGDEY KALAN	AMR	OK	31.03.2023	AP 3Phase 3Wire				2067179	900-450/577/1-1-1	0.000	NA	Director/D	
B.1063	Border	SUB URBAN AMRITSAR	11KV	DS S/U DIVN. AMRITSAR	DS S/D HARSHA CHINNA	0824F02	ADLIWAL/RS	AMR	OK	31.03.2023	AP 3Phase 3Wire				2065865	1200/577/1-1-1	2.301	NA	Director/D	
B.1064	Border	SUB URBAN AMRITSAR	11KV	DS S/U DIVN. AMRITSAR	DS S/D HARSHA CHINNA	0824F04	HEIR	AMR	OK	31.03.2023	AP 3Phase 3Wire				2047092	1200/577/1-1-1	2.392	NA	Director/D	
B.1065	Border	SUB URBAN AMRITSAR	11KV	DS S/U DIVN. AMRITSAR	DS S/D HARSHA CHINNA	0824F09	AIR FORCE STATION	AMR	OK	31.03.2023	Category 4				9534409	1200/577/1-1-1	2.452	NA	Director/D	
B.1066	Border	SUB URBAN AMRITSAR	11KV	DS S/U DIVN. AMRITSAR	DS S/D HARSHA CHINNA	0824F05	KAMBO	AMR	OK	31.03.2023	Category 5-UPS				2047083	1200/577/1-1-1	4.996	NA	Director/D	
B.1067	Border	SUB URBAN AMRITSAR	11KV	DS S/U DIVN. AMRITSAR	DS S/D HARSHA CHINNA	0824F03	AIR PORT - 2	AMR	OK	31.03.2023	Category 4				6781923	900-450/577/1-1-1	6.921	NA	Director/D	
B.1068	Border	SUB URBAN AMRITSAR	11KV	DS S/U DIVN. AMRITSAR	DS S/D HARSHA CHINNA	0824F06	AIR PORT - 1	NON AMR	OK	31.03.2023	Category 4				6785321	900-450/577/1-1-1	7.281	NA	Director/D	
B.1069	Border	SUB URBAN AMRITSAR	11KV	DS S/U DIVN. AMRITSAR	DS S/D HARSHA CHINNA	0824F10	RAJISSON	AMR	OK	31.03.2023	Category 1				12093426	900-450/577/1-1-1	9.314	NA	Director/D	
B.1070	Border	SUB URBAN AMRITSAR	11KV	DS S/U DIVN. AMRITSAR	DS S/D HARSHA CHINNA	0824F07	GURU NANAKPURA	AMR	OK	31.03.2023	Category 1				2047168	1200/577/1-1-1	9.848	NA	Director/D	
B.1071	Border	SUB URBAN AMRITSAR	11KV	DS S/U DIVN. AMRITSAR	DS S/D HARSHA CHINNA	0824F08	BAL SACHANDER	AMR	OK	31.03.2023	Category 5-UPS				2068830	1200/577/1-1-1	13.940	NA	Director/D	
B.1072	Border	SUB URBAN AMRITSAR	11KV	DS S/U DIVN. AMRITSAR	DS S/D HARSHA CHINNA	0824F01	RAJASANSI/RS	AMR	OK	31.03.2023	Category 1				2040478	1200/577/1-1-1	20.894	NA	Director/D	
B.1073	Border	SUB URBAN AMRITSAR	11KV	DS S/U DIVN. AMRITSAR	DS S/D KATHUNANGAL	0827F08	RAM DIWALI	AMR	OK	31.03.2023	AP 3Phase 3Wire				2067237	1200-450/5	0.743	NA	Director/D	
B.1074	Border	SUB URBAN AMRITSAR	11KV	DS S/U DIVN. AMRITSAR	DS S/D KATHUNANGAL	0827F12	MALLIHAL	AMR	OK	31.03.2023	AP 3Phase 3Wire				8222587	1200/577/1-1-1	1.159	NA	Director/D	
B.1075	Border	SUB URBAN AMRITSAR	11KV	DS S/U DIVN. AMRITSAR	DS S/D KATHUNANGAL	0827F07	RUPWALI	AMR	OK	31.03.2023	AP 3Phase 3Wire				8222528	1200/577/1-1-1	1.273	NA	Director/D	
B.1076	Border	SUB URBAN AMRITSAR	11KV	DS S/U DIVN. AMRITSAR	DS S/D KATHUNANGAL	0827F02	LEHRKA	AMR	OK	31.03.2023	AP 3Phase 3Wire				2067873	900-450/577/1-1-1	1.828	NA	Director/D	
B.1077	Border	SUB URBAN AMRITSAR	11KV	DS S/U DIVN. AMRITSAR	DS S/D KATHUNANGAL	0827F01	CHAWINDA DEVI	AMR	OK	31.03.2023	AP 3Phase 3Wire				2067872	900-450/577/1-1-1	2.128	NA	Director/D	
B.1078	Border	SUB URBAN AMRITSAR	11KV	DS S/U DIVN. AMRITSAR	DS S/D KATHUNANGAL	0827F10	ETHUWAL	AMR	OK	31.03.2023	AP 3Phase 3Wire				2066178	1200/577/1-1-1	2.219	NA	Director/D	
B.1079	Border	SUB URBAN AMRITSAR	11KV	DS S/U DIVN. AMRITSAR	DS S/D KATHUNANGAL	0827F11	ETHUWAL	AMR	OK	31.03.2023	AP 3Phase 3Wire				8221289	1200/577/1-1-1	1.008	NA	Director/D	
B.1080	Border	SUB URBAN AMRITSAR	11KV	DS S/U DIVN. AMRITSAR	DS S/D KATHUNANGAL	0827F09	AJAWALI	AMR	OK	31.03.2023	AP 3Phase 3Wire				9149098	1200/577/1-1-1	3.456	NA	Director/D	
B.1081	Border	SUB URBAN AMRITSAR	11KV	DS S/U DIVN. AMRITSAR	DS S/D KATHUNANGAL	0827F-3	Kaler Mangat	AMR	OK	31.03.2023	Category 5-UPS				11114600	900-450/577/1-1-1	9.772	NA	Director/D	
B.1082	Border	SUB URBAN AMRITSAR	11KV	DS S/U DIVN. AMRITSAR	DS S/D KATHUNANGAL	0827F06	24 HORS TALWANDI	AMR	OK	31.03.2023	Category 5-UPS				2067736	1200/577/1-1-1	11.039	NA	Director/D	
B.1083	Border	SUB URBAN AMRITSAR	11KV	DS S/U DIVN. AMRITSAR	DS S/D KATHUNANGAL	0827F03	KOTLA URBAN	AMR	OK	31.03.2023	Category 5-UPS				11114007	900-450/577/1-1-1	11.752	NA	Director/D	
B.1084	Border	SUB URBAN AMRITSAR	11KV	DS S/U DIVN. AMRITSAR	DS S/D KATHUNANGAL	0827F08	BABA BUREM SAHIB	AMR	OK	31.03.2023	Category 1				1507946	1200/577/1-1-1	15.026	NA	Director/D	
B.1085	Border	SUB URBAN AMRITSAR	11KV	DS S/U DIVN. AMRITSAR	DS S/D KATHUNANGAL	0825F09	BABA JEEN SHAH	AMR	OK	31.03.2023	AP 3Phase 3Wire				158703225	900-450/577/1-1-1	1.725	NA	Director/D	
B.1086	Border	SUB URBAN AMRITSAR	11KV	DS S/U DIVN. AMRITSAR	DS S/D KATHUNANGAL	0825F1-3	Bajuman	AMR	OK	31.03.2023	AP 3Phase 3Wire				2067572	900-450/577/1-1-1	2.285	NA	Director/D	
B.1087	Border	SUB URBAN AMRITSAR	11KV	DS S/U DIVN. AMRITSAR	DS S/D KATHUNANGAL	0825F06	ABDAL	AMR	OK	31.03.2023	Category 5-UPS				117025	900-450/577/1-1-1	7.920	NA	Director/D	
B.1088	Border	SUB URBAN AMRITSAR	11KV	DS S/U DIVN. AMRITSAR	DS S/D KATHUNANGAL	0825F15	WARIYAM UPS	AMR	OK	31.03.2023	Category 5-UPS				73195935	900-450/577/1-1-1	8.602	NA	Director/D	
B.1089	Border	SUB URBAN AMRITSAR	11KV	DS S/U DIVN. AMRITSAR	DS S/D KATHUNANGAL	0804F07	SOKH KURAND	AMR	OK	31.03.2023	AP 3Phase 3Wire				21381	1200/577/1-1-1	1.494	NA	Director/D	
B.1090	Border	SUB URBAN AMRITSAR	11KV	DS S/U DIVN. AMRITSAR	DS S/D KATHUNANGAL	0824F05	PATENGARI SHUKERCHAK	AMR	OK	31.03.2023	AP 3Phase 3Wire				2065789	1200/577/1-1-1	1.467	NA	Director/D	
B.1091	Border	SUB URBAN AMRITSAR	11KV	DS S/U DIVN. AMRITSAR	DS S/D KATHUNANGAL	0804F03	VERKA RURAL	AMR	OK	31.03.2023	AP 3Phase 3Wire				2066967	900-450/577/1-1-1	1.690	NA	Director/D	
B.1092	Border	SUB URBAN AMRITSAR	11KV	DS S/U DIVN. AMRITSAR	DS S/D KATHUNANGAL	0804F05	MUDHAL RURAL	AMR	OK	31.03.2023	AP 3Phase 3Wire				2066326	1200/577/1-1-1	1.902	NA	Director/D	
B.1093	Border	SUB URBAN AMRITSAR	11KV	DS S/U DIVN. AMRITSAR	DS S/D KATHUNANGAL	0804F06	24HRS MUDHAL	AMR	OK	31.03.2023	Category 5-UPS				7336465	1200/577/1-1-1	2.845	NA	Director/D	
B.1094	Border	SUB URBAN AMRITSAR	11KV	DS S/U DIVN. AMRITSAR	DS S/D KATHUNANGAL	0804F08	JANGHIR UPS	NON AMR	OK	31.03.2023	Category 5-UPS				3020200352	1200/577/1-1-1	7.332	NA	Director/D	
B.1095	Border	SUB URBAN AMRITSAR	11KV	DS S/U DIVN. AMRITSAR	DS S/D KATHUNANGAL	0827F01	KOT	NON AMR	OK	31.03.2023	AP 3Phase 3Wire				7336634	1200-450/5	0.857	NA	Director/D	
B.1096	Border	SUB URBAN AMRITSAR	11KV	DS S/U DIVN. AMRITSAR	DS S/D KATHUNANGAL	0827F02	KOT	NON AMR	OK	31.03.2023	AP 3Phase 3Wire				7336627	900-450/5	1.177	NA	Director/D	
B.1097	Border	SUB URBAN AMRITSAR	11KV	DS S/U DIVN. AMRITSAR	DS S/D KATHUNANGAL	0826F07	MANGA SARAI	NON AMR	OK	31.03.2023	AP 3Phase 3Wire				15196157	900-450/5	1.307	NA	Director/D	
B.1098	Border	SUB URBAN AMRITSAR	11KV	DS S/U DIVN. AMRITSAR	DS S/D KATHUNANG															

S.No	Zone	Circle	Voltage Level (kVA)	Division (kVA)	Sub-Division (kVA)	Feeder ID	Feeder Name	Feeder Metering Status (Metered/unmetered/AMR/AMI)	Status of Meter (Functional/Non-Functional)	Metering Date (Date of last actual meter reading/communication)	Feeder Type (Agr./Industrial/Mixed)	Status of Communication			Period from 01.04.2021 to 31.03.2022				Sales	Remarks (Source of data)
												% data received through automatically by feeder AMR/AMI	Number of hours when meter was unable to communicate in overall	Total Number of hours in the period	Meter S.No	CT/PT ratio	Import (kWh)	Export (kWh)		
B.1134	Border	SUB URBAN AMRITSAR	11KV	DS S/U DIVN. AMRITSAR	DS S/D NO-1 MAIHTHA	0831F02	Industry NAG	AMR	OK	31.03.2023	Category 2				777341	900-450/577/1-1	14.247	NA	Director/D	
B.1135	Border	SUB URBAN AMRITSAR	11KV	DS S/U DIVN. AMRITSAR	DS S/D NO-1 MAIHTHA	0831F10	GAURI SHANKAR	AMR	OK	31.03.2023	Category 2				4312	900-450/577/1-1	15.610	NA	Director/D	
B.1136	Border	SUB URBAN AMRITSAR	11KV	DS S/U DIVN. AMRITSAR	DS S/D NO-1 MAIHTHA	0831F07	Sudeshi Korean	AMR	OK	31.03.2023	Category 2				738844	900-450/577/1-1	16.290	NA	Director/D	
B.1137	Border	SUB URBAN AMRITSAR	11KV	DS S/U DIVN. AMRITSAR	DS S/D NO-1 MAIHTHA	0831F08	BAJ KALAN INDUSTRY	AMR	OK	31.03.2023	Category 2				371126	900-450/577/1-1	19.172	NA	Director/D	
B.1138	Border	SUB URBAN AMRITSAR	11KV	DS S/U DIVN. AMRITSAR	DS S/D NO-2 MAIHTHA	0807F05	BABA NAMDEV II AP	AMR	OK	31.03.2023	AP Phase 3WIRE				822774	900-450/577/1-1	1.401	NA	Director/D	
B.1139	Border	SUB URBAN AMRITSAR	11KV	DS S/U DIVN. AMRITSAR	DS S/D NO-2 MAIHTHA	8803F14	BHOMA AP 1	AMR	OK	31.03.2023	AP Phase 3WIRE				2067514	200-100/5-5	0.058	NA	Director/D	
B.1140	Border	SUB URBAN AMRITSAR	11KV	DS S/U DIVN. AMRITSAR	DS S/D NO-2 MAIHTHA	8803F06	BHAGWAN AP 1	AMR	OK	31.03.2023	AP Phase 3WIRE				2067250	200-100/5-5	0.614	NA	Director/D	
B.1141	Border	SUB URBAN AMRITSAR	11KV	DS S/U DIVN. AMRITSAR	DS S/D NO-2 MAIHTHA	8804F07	TARPAI	AMR	OK	31.03.2023	AP Phase 3WIRE				1117096	1200-600/5	1.310	NA	Director/D	
B.1142	Border	SUB URBAN AMRITSAR	11KV	DS S/U DIVN. AMRITSAR	DS S/D NO-2 MAIHTHA	8804F10	BURAI NOBADA AP	AMR	OK	31.03.2023	AP Phase 3WIRE				2067267	1200-600/5	1.567	NA	Director/D	
B.1143	Border	SUB URBAN AMRITSAR	11KV	DS S/U DIVN. AMRITSAR	DS S/D NO-2 MAIHTHA	8804F08	SHAM NAGAR AP	AMR	OK	31.03.2023	AP Phase 3WIRE				2066286	1200-600/5	1.579	NA	Director/D	
B.1144	Border	SUB URBAN AMRITSAR	11KV	DS S/U DIVN. AMRITSAR	DS S/D NO-2 MAIHTHA	8804F08	HAMZA AP	AMR	OK	31.03.2023	AP Phase 3WIRE				11116797	1200-600/5	1.732	NA	Director/D	
B.1145	Border	SUB URBAN AMRITSAR	11KV	DS S/U DIVN. AMRITSAR	DS S/D NO-2 MAIHTHA	8804F14	KOTLA SULTAN SINGH UPS	AMR	OK	31.03.2023	Category 5-UPS				2066768	1200-600/5	12.427	NA	Director/D	
B.1146	Border	SUB URBAN AMRITSAR	11KV	DS S/U DIVN. AMRITSAR	DS S/D NO-2 MAIHTHA	0858F13	BABA BIR SINGH	AMR	OK	31.03.2023	AP Phase 3WIRE				15193830	1200/577/1-1	0.891	NA	Director/D	
B.1147	Border	SUB URBAN AMRITSAR	11KV	DS S/U DIVN. AMRITSAR	DS S/D NO-2 MAIHTHA	0858F11	BABA LANGAH AP	AMR	OK	31.03.2023	AP Phase 3WIRE				34390	900-450/577/1-1	1.456	NA	Director/D	
B.1148	Border	SUB URBAN AMRITSAR	11KV	DS S/U DIVN. AMRITSAR	DS S/D NO-2 MAIHTHA	0858F09	THREWAL	AMR	OK	31.03.2023	AP Phase 3WIRE				1951163	900-450/577/1-1	1.528	NA	Director/D	
B.1149	Border	SUB URBAN AMRITSAR	11KV	DS S/U DIVN. AMRITSAR	DS S/D NO-2 MAIHTHA	0853F07	Bhangali AP	AMR	OK	31.03.2023	AP Phase 3WIRE				2111960	900-450/577/1-1	1.603	NA	Director/D	
B.1150	Border	SUB URBAN AMRITSAR	11KV	DS S/U DIVN. AMRITSAR	DS S/D NO-2 MAIHTHA	0858F16	TALWANDI AP	AMR	OK	31.03.2023	AP Phase 3WIRE				36787	1200/577/1-1	1.644	NA	Director/D	
B.1151	Border	SUB URBAN AMRITSAR	11KV	DS S/U DIVN. AMRITSAR	DS S/D NO-2 MAIHTHA	0858F03	PAROWAL	AMR	OK	31.03.2023	AP Phase 3WIRE				1957169	1200/577/1-1	2.041	NA	Director/D	
B.1152	Border	SUB URBAN AMRITSAR	11KV	DS S/U DIVN. AMRITSAR	DS S/D NO-2 MAIHTHA	0858F08	G.T.S. Bhangali 24 HR	NON AMR	OK	31.03.2023	Category 5-UPS				7386747	1200/577/1-1	2.587	NA	Director/D	
B.1153	Border	SUB URBAN AMRITSAR	11KV	DS S/U DIVN. AMRITSAR	DS S/D NO-2 MAIHTHA	0858F02	Chachowal 24 HR	NON AMR	OK	31.03.2023	Category 5-UPS				1957153	900-450/577/1-1	3.731	NA	Director/D	
B.1154	Border	SUB URBAN AMRITSAR	11KV	DS S/U DIVN. AMRITSAR	DS S/D NO-2 MAIHTHA	0858F15	JITIAN UPS	NON AMR	OK	31.03.2023	Category 5-UPS				30255	900-450/577/1-1	7.572	NA	Director/D	
B.1155	Border	SUB URBAN AMRITSAR	11KV	DS S/U DIVN. AMRITSAR	DS S/D NO-2 MAIHTHA	0858F07	BABA NAMDEV II UPS	AMR	OK	31.03.2023	Category 5-UPS				6669584	900-450/577/1-1	9.033	NA	Director/D	
B.1156	Border	SUB URBAN AMRITSAR	11KV	DS S/U DIVN. AMRITSAR	DS S/D NO-2 MAIHTHA	0841F06	BABA SRI CHAND AP	AMR	OK	31.03.2023	AP Phase 3WIRE				73195311	900-450/577/1-1	0.668	NA	Director/D	
B.1157	Border	SUB URBAN AMRITSAR	11KV	DS S/U DIVN. AMRITSAR	DS S/D NO-2 MAIHTHA	0841F02	JALPURA UPS	AMR	OK	31.03.2023	Category 1				40197976	900-450/577/1-1	1.382	NA	Director/D	
B.1158	Border	SUB URBAN AMRITSAR	11KV	DS S/U DIVN. AMRITSAR	DS S/D NO-2 MAIHTHA	0841F03	KOTLA SULTAN SINGH AP	AMR	OK	31.03.2023	AP Phase 3WIRE				40197979	900-450/577/1-1	1.404	NA	Director/D	
B.1159	Border	SUB URBAN AMRITSAR	11KV	DS S/U DIVN. AMRITSAR	DS S/D NO-2 MAIHTHA	0841F05	JOGI KALAN AP	AMR	OK	31.03.2023	AP Phase 3WIRE				40197977	900-450/577/1-1	1.571	NA	Director/D	
B.1160	Border	SUB URBAN AMRITSAR	11KV	DS S/U DIVN. AMRITSAR	DS S/D NO-2 MAIHTHA	0841F01	DHING NANGAL AP	AMR	OK	31.03.2023	AP Phase 3WIRE				40197926	900-450/577/1-1	1.978	NA	Director/D	
B.1161	Border	SUB URBAN AMRITSAR	11KV	DS S/U DIVN. AMRITSAR	DS S/D NO-2 MAIHTHA	0841F04	BOREWAL UPS	AMR	OK	31.03.2023	Category 5-UPS				40197978	900-450/577/1-1	3.976	NA	Director/D	
B.1162	Border	SUB URBAN AMRITSAR	11KV	DS S/U DIVN. AMRITSAR	DS S/D NO-2 MAIHTHA	0827F12	JOHAL AP	AMR	OK	31.03.2023	AP Phase 3WIRE				197851	900-450/577/1-1	0.776	NA	Director/D	
B.1163	Border	SUB URBAN AMRITSAR	11KV	DS S/U DIVN. AMRITSAR	DS S/D NO-2 MAIHTHA	0827F04	BHOMA AP 2	AMR	OK	31.03.2023	AP Phase 3WIRE				70336412	900-450/577/1-1	0.963	NA	Director/D	
B.1164	Border	SUB URBAN AMRITSAR	11KV	DS S/U DIVN. AMRITSAR	DS S/D NO-2 MAIHTHA	0827F01	BHAGWAN AP 2	AMR	OK	31.03.2023	AP Phase 3WIRE				7386507	900-450/577/1-1	1.110	NA	Director/D	
B.1165	Border	SUB URBAN AMRITSAR	11KV	DS S/U DIVN. AMRITSAR	DS S/D NO-2 MAIHTHA	0827F08	KOTLA GURBAN AP	AMR	OK	31.03.2023	AP Phase 3WIRE				13109557	900-450/577/1-1	1.174	NA	Director/D	
B.1166	Border	SUB URBAN AMRITSAR	11KV	DS S/U DIVN. AMRITSAR	DS S/D NO-2 MAIHTHA	0827F13	BUDHA THEH AP	AMR	OK	31.03.2023	AP Phase 3WIRE				7386496	900-450/577/1-1	1.245	NA	Director/D	
B.1167	Border	SUB URBAN AMRITSAR	11KV	DS S/U DIVN. AMRITSAR	DS S/D NO-2 MAIHTHA	0827F09	MADHPURA AP	NON AMR	OK	31.03.2023	AP Phase 3WIRE				15194767	900-450/577/1-1	1.395	NA	Director/D	
B.1168	Border	SUB URBAN AMRITSAR	11KV	DS S/U DIVN. AMRITSAR	DS S/D NO-2 MAIHTHA	0827F10	BABA ROZEE SHAH	AMR	OK	31.03.2023	AP Phase 3WIRE				197900	900-450/577/1-1	1.649	NA	Director/D	
B.1169	Border	SUB URBAN AMRITSAR	11KV	DS S/U DIVN. AMRITSAR	DS S/D NO-2 MAIHTHA	082706	UNARPURA UPS	AMR	OK	31.03.2023	Category 5-UPS				11052011	900-450/577/1-1	1.920	NA	Director/D	
B.1170	Border	SUB URBAN AMRITSAR	11KV	DS S/U DIVN. AMRITSAR	DS S/D NO-2 MAIHTHA	0827F14	SANT BHAGAT SINGH UPS	AMR	OK	31.03.2023	Category 1				4482	900-450/577/1-1	5.468	NA	Director/D	
B.1171	Border	SUB URBAN AMRITSAR	11KV	DS S/U DIVN. AMRITSAR	DS S/D NO-2 MAIHTHA	0827F03	WALLA VERAM CAT 1	AMR	OK	31.03.2023	Category 1				7042824	900-450/577/1-1	6.090	NA	Director/D	
B.1172	Border	SUB URBAN AMRITSAR	11KV	DS S/U DIVN. AMRITSAR	DS S/D NO-2 MAIHTHA	0827F07	PANDER UPS	AMR	OK	31.03.2023	Category 5-UPS				7336555	900-450/577/1-1	11.219	NA	Director/D	
B.1173	Border	SUB URBAN AMRITSAR	11KV	DS S/U DIVN. AMRITSAR	DS S/D UDHOKHE	10C3C852	KOTLI DHOLE SHAH	AMR	OK	31.03.2023	KU Phase 3WIRE				2067303	900-450/577/1-1	1.301	NA	Director/D	
B.1174	Border	SUB URBAN AMRITSAR	11KV	DS S/U DIVN. AMRITSAR	DS S/D UDHOKHE	C852F08	Khera Bala Chak	AMR	OK	31.03.2023	AP Phase 3WIRE				23667	900-450/577/1-1	1.316	NA	Director/D	
B.1175	Border	SUB URBAN AMRITSAR	11KV	DS S/U DIVN. AMRITSAR	DS S/D UDHOKHE	C852F01	Jaindigur	NON AMR	OK	31.03.2023	AP Phase 3WIRE				2068482	900-450/577/1-1	1.515	NA	Director/D	
B.1176	Border	SUB URBAN AMRITSAR	11KV	DS S/U DIVN. AMRITSAR	DS S/D UDHOKHE	0858F01	Manji Lal Fural	AMR	OK	31.03.2023	AP Phase 3WIRE				9140800	900-450/577/1-1	1.806	NA	Director/D	
B.1177	Border	SUB URBAN AMRITSAR	11KV	DS S/U DIVN. AMRITSAR	DS S/D UDHOKHE	8805F12	UJS SARHALLA	NON AMR	OK	31.03.2023	Category 5-UPS				11117025	900-450/577/1-1	7.840	NA	Director/D	
B.1178	Border	SUB URBAN AMRITSAR	11KV	DS S/U DIVN. AMRITSAR	DS S/D UDHOKHE	C833F04	Palahapura	AMR	OK	31.03.2023	Category 5-UPS				11116813	900-450/577/1-1	10.582	NA	Director/D	
B.1179	Border	SUB URBAN AMRITSAR	11KV	DS S/U DIVN. AMRITSAR	DS S/D UDHOKHE	0837F02	GADARAZADA	AMR	OK	31.03.2023	AP Phase 3WIRE				36697	900-450/577/1-1	0.869	NA	Director/D	
B.1180	Border	SUB URBAN AMRITSAR	11KV	DS S/U DIVN. AMRITSAR	DS S/D UDHOKHE	0837F04	BABA SARUP DAS	AMR	OK	31.03.2023	AP Phase 3WIRE				36671	900-450/577/1-1	1.185	NA	Director/D	
B.1181	Border	SUB URBAN AMRITSAR	11KV	DS S/U DIVN. AMRITSAR	DS S/D UDHOKHE	0837F03	BUSI RAOHWALI	NON AMR	OK	31.03.2023	Category 5-UPS				36678	900-450/577/1-1	3.303	NA	Director/D	
B.1182	Border	SUB URBAN AMRITSAR	11KV	DS S/U DIVN. AMRITSAR	DS S/D UDHOKHE	0826F13	Gadarpada	AMR	OK	31.03.2023	AP Phase 3WIRE				7386410	900-450/5	1.675	NA	Director/D	
B.1183	Border	SUB URBAN AMRITSAR	11KV	DS S/U DIVN. AMRITSAR	DS S/D UDHOKHE	0826F16	BABOWAL UPS	AMR	OK	31.03.2023	Category 5-UPS				36844	900-450/5	1.819	NA	Director/D	
B.1184	Border	SUB URBAN AMRITSAR	11KV	DS S/U DIVN. AMRITSAR	DS S/D UDHOKHE	8805F06	JHAMKA	AMR	OK	31.03.2023	AP Phase 3WIRE				8222733	900-450/577/1-1	0.745	NA	Director/D	
B.1185	Border	SUB URBAN AMRITSAR	11KV	DS S/U DIVN. AMRITSAR	DS S/D UDHOKHE	8805F07	KADRA BAD	AMR	OK	31.03.2023	AP Phase 3WIRE				2068098	900-450/5	1.094	NA	Director/D	
B.1186	Border	SUB URBAN AMRITSAR	11KV	DS S/U DIVN. AMRITSAR	DS S/D UDHOKHE	8805F08	RAM DAWLI	AMR	OK	31.03.2023	AP Phase 3WIRE				8223074	900-450/577/1-1	1.219	NA	Director/D	
B.1187	Border	SUB URBAN AMRITSAR	11KV	DS S/U DIVN. AMRITSAR	DS S/D UDHOKHE	8805F09	FAMU SAHIB	AMR	OK	31.03.2023	AP Phase 3WIRE				8222721	900-450/5	1.211	NA	Director/D	
B.1188	Border	SUB URBAN AMRITSAR	11KV	DS S/U DIVN. AMRITSAR	DS S/D UDHOKHE	8805F13	ATWAL	AMR	OK	31.03.2023	AP Phase 3WIRE				23589	900-450/577/1-1	1.489	NA	Director/D	
B.1189	Border	SUB URBAN AMRITSAR	11KV	DS S/U DIVN. AMRITSAR	DS S/D UDHOKHE	8805F05	SARCOOPWALI	AMR	OK	31.03.2023	AP Phase 3WIRE				8222581	900-450/577/1-1	1.579	NA	Director/D	
B.1190	Border	SUB URBAN AMRITSAR	11KV	DS S/U DIVN. AMRITSAR	DS S/D UDHOKHE	8805F01	BAGGA	AMR	OK	31.03.2023	AP Phase 3WIRE				8222732	900-450/5	1.787	NA	Director/D	
B.1191	Border	SUB URBAN AMRITSAR	11KV	DS S/U DIVN. AMRITSAR	DS S/D UDHOKHE	8805F10	UJS UDHOKHE	AMR	OK	31.03.2023	Category 5-UPS				266100	900-450/577/1-1	3.356	NA	Director/D	
B.1192	Border	SUB URBAN AMRITSAR	11KV	DS S/U DIVN. AMRITSAR	DS S/D UDHOKHE	8805F03	UJS UDHOKHE	AMR	OK	31.03.2023	Category 5-UPS				5390363	900-450/577/1-1	3.568	NA	Director/D	
B.1193	Border	SUB URBAN AMRITSAR	11KV	DS S/U DIVN. AMRITSAR	DS S/D UDHOKHE	8805F14	Rupowal UPS	AMR	OK	31.03.2023	Category 5-UPS				98824368	900-450/5	4.403	NA	Director/D	
B.1194	Border	SUB URBAN AMRITSAR	11KV	DS S/U DIVN. AMRITSAR	DS S/D UDHOKHE	8805F15	UJS SILAKA	AMR	OK	31.03.2023	Category 5-UPS				23655	900-450/5	7.044	NA		

S.No	Zone	Circle	Voltage Level (kVA)	Division (kVA)	Sub-Division (kVA)	Feeder ID	Feeder Name	Feeder Metering Status (Metered/unmetered/AMR/AMI)	Status of Meter (Functional/Non-Functional)	Metering Date (Date of last actual meter reading/communication)	Feeder Type (Agr./Industrial/Mixed)	Status of Communication			Period from 01.04.2021 to 31.03.2022				Sales	Remarks (Source of data)
												% data received through automatically if feeder AMR/AMI	Number of hours when meter was unable to communicate in overall	Total Number of hours in the period	Meter S.No	CT/PT ratio	Import (kWh)	Export (kWh)		
B.1231	Border	SUB URBAN AMRITSAR	11KV	DS WEST DIVN. ASR	DS S/D ATTARI	0816FL02	Daukey	AMR	OK	31.03.2023	AP 3Phase 3Wire				23427	900-450/5	1.601	NA	Director/D	
B.1232	Border	SUB URBAN AMRITSAR	11KV	DS WEST DIVN. ASR	DS S/D ATTARI	0816FL07	RAATAL URBAN	NON AMR	OK	31.03.2023	Category 1				9534444	900-450/5	1.944	NA	Director/D	
B.1233	Border	SUB URBAN AMRITSAR	11KV	DS WEST DIVN. ASR	DS S/D ATTARI	0816FL04	Rajgala	NON AMR	OK	31.03.2023	AP 3Phase 3Wire				2066708	1200-600/5	1.964	NA	Director/D	
B.1234	Border	SUB URBAN AMRITSAR	11KV	DS WEST DIVN. ASR	DS S/D ATTARI	0816FL08	11 KV MANHIA	NON AMR	OK	31.03.2023	Category 1				8223266	1200-600/5	1.970	NA	Director/D	
B.1235	Border	SUB URBAN AMRITSAR	11KV	DS WEST DIVN. ASR	DS S/D ATTARI	0816FL01	Bhaini Bagautan	AMR	OK	31.03.2023	AP 3Phase 3Wire				30313	1200-600/5	2.719	NA	Director/D	
B.1236	Border	SUB URBAN AMRITSAR	11KV	DS WEST DIVN. ASR	DS S/D ATTARI	0816FL12	BABA NAHAR SINGH	AMR	OK	31.03.2023	Category 5-U/PS				4500	1200-600/5	3.984	NA	Director/D	
B.1237	Border	SUB URBAN AMRITSAR	11KV	DS WEST DIVN. ASR	DS S/D ATTARI	0816FL06	24 Hrs Rajatal	AMR	OK	31.03.2023	Category 5-U/PS				23179	900-450/5	6.539	NA	Director/D	
B.1238	Border	SUB URBAN AMRITSAR	11KV	DS WEST DIVN. ASR	DS S/D ATTARI	0816FL10	BHUSSE	AMR	OK	31.03.2023	Category 5-U/PS				1519387	900-450/5	5.999	NA	Director/D	
B.1239	Border	SUB URBAN AMRITSAR	11KV	DS WEST DIVN. ASR	DS S/D CHOGAWAN	0283FL07	GLUMTALA	AMR	OK	31.03.2023	Category 1				5489709	1200/577/1-1	0.406	NA	Director/D	
B.1240	Border	SUB URBAN AMRITSAR	11KV	DS WEST DIVN. ASR	DS S/D CHOGAWAN	0283FL05	RAM TIRATH	NON AMR	OK	31.03.2023	AP 3Phase 3Wire				2066267	900-450/577/1-1	1.379	NA	Director/D	
B.1241	Border	SUB URBAN AMRITSAR	11KV	DS WEST DIVN. ASR	DS S/D CHOGAWAN	0835FL07	NAWA PIND	AMR	OK	31.03.2023	AP 3Phase 3Wire				4914	900-450/577/1-1	1.039	NA	Director/D	
B.1242	Border	SUB URBAN AMRITSAR	11KV	DS WEST DIVN. ASR	DS S/D CHOGAWAN	0835FL03	11 KV DHOL KHURD	AMR	OK	31.03.2023	AP 3Phase 3Wire				10282994	900-450/577/1-1	1.233	NA	Director/D	
B.1243	Border	SUB URBAN AMRITSAR	11KV	DS WEST DIVN. ASR	DS S/D CHOGAWAN	0835FL05	11 KV BAWEAWALI	AMR	OK	31.03.2023	AP 3Phase 3Wire				7039578	900-450/5	1.587	NA	Director/D	
B.1244	Border	SUB URBAN AMRITSAR	11KV	DS WEST DIVN. ASR	DS S/D CHOGAWAN	0835FL02	11 KV WADALA RURAL	AMR	OK	31.03.2023	AP 3Phase 3Wire				10283772	900-450/577/1-1	1.921	NA	Director/D	
B.1245	Border	SUB URBAN AMRITSAR	11KV	DS WEST DIVN. ASR	DS S/D CHOGAWAN	0835FL21	SEWAGE TREATMENT PLANT	AMR	OK	31.03.2023	Category 4				7039572	900-450/5	3.385	NA	Director/D	
B.1246	Border	SUB URBAN AMRITSAR	11KV	DS WEST DIVN. ASR	DS S/D CHOGAWAN	0835FL04	BS	AMR	OK	31.03.2023	Category 5-U/PS				10283010	900-450/577/1-1	6.477	NA	Director/D	
B.1247	Border	SUB URBAN AMRITSAR	11KV	DS WEST DIVN. ASR	DS S/D CHOGAWAN	0835FL01	11 KV WADALA	AMR	OK	31.03.2023	Category 5-U/PS				10282781	900-450/577/1-1	10.183	NA	Director/D	
B.1248	Border	SUB URBAN AMRITSAR	11KV	DS WEST DIVN. ASR	DS S/D CHOGAWAN	0829FL04	TOLA NAGAL	AMR	OK	31.03.2023	AP 3Phase 3Wire				8223557	900-450/577/1-1	1.921	NA	Director/D	
B.1249	Border	SUB URBAN AMRITSAR	11KV	DS WEST DIVN. ASR	DS S/D CHOGAWAN	0829FL01	KOTLI SAKKA	AMR	OK	31.03.2023	AP 3Phase 3Wire				7030203	900-450/577/1-1	2.095	NA	Director/D	
B.1250	Border	SUB URBAN AMRITSAR	11KV	DS WEST DIVN. ASR	DS S/D CHOGAWAN	0829FL07	AP JHANOTI	AMR	OK	31.03.2023	AP 3Phase 3Wire				15194381	900-450/577/1-1	2.246	NA	Director/D	
B.1251	Border	SUB URBAN AMRITSAR	11KV	DS WEST DIVN. ASR	DS S/D CHOGAWAN	0829FL03	BAGGA RURAL	AMR	OK	31.03.2023	AP 3Phase 3Wire				15194705	900-450/577/1-1	2.285	NA	Director/D	
B.1252	Border	SUB URBAN AMRITSAR	11KV	DS WEST DIVN. ASR	DS S/D CHOGAWAN	0829FL05	11 KVA URBAN BAGGA	AMR	OK	31.03.2023	Category 1				37233	900-450/577/1-1	3.164	NA	Director/D	
B.1253	Border	SUB URBAN AMRITSAR	11KV	DS WEST DIVN. ASR	DS S/D CHOGAWAN	0829FL02	MANAWALA UPS	AMR	OK	31.03.2023	Category 5-U/PS				11117280	900-450/577/1-1	7.130	NA	Director/D	
B.1254	Border	SUB URBAN AMRITSAR	11KV	DS WEST DIVN. ASR	DS S/D CHOGAWAN	0829FL06	UPS JAHNOTI	AMR	OK	31.03.2023	Category 5-U/PS				15193914	900-450/577/1-1	8.762	NA	Director/D	
B.1255	Border	SUB URBAN AMRITSAR	11KV	DS WEST DIVN. ASR	DS S/D CHOGAWAN	0818FL01	Kotlia	AMR	OK	31.03.2023	AP 3Phase 3Wire				2066922	900-450/5	1.410	NA	Director/D	
B.1256	Border	SUB URBAN AMRITSAR	11KV	DS WEST DIVN. ASR	DS S/D CHOGAWAN	0818FL04	Champur	AMR	OK	31.03.2023	AP 3Phase 3Wire				8223457	900-450/5	1.983	NA	Director/D	
B.1257	Border	SUB URBAN AMRITSAR	11KV	DS WEST DIVN. ASR	DS S/D CHOGAWAN	0818FL06	Bhiredw	AMR	OK	31.03.2023	AP 3Phase 3Wire				2066565	900-450/5	1.824	NA	Director/D	
B.1258	Border	SUB URBAN AMRITSAR	11KV	DS WEST DIVN. ASR	DS S/D CHOGAWAN	0818FL21	ODDAR	AMR	OK	31.03.2023	AP 3Phase 3Wire				15194765	1200-600/5	2.020	NA	Director/D	
B.1259	Border	SUB URBAN AMRITSAR	11KV	DS WEST DIVN. ASR	DS S/D CHOGAWAN	0818FL03	Jhanoti	AMR	OK	31.03.2023	AP 3Phase 3Wire				7042888	900-450/5	2.266	NA	Director/D	
B.1260	Border	SUB URBAN AMRITSAR	11KV	DS WEST DIVN. ASR	DS S/D CHOGAWAN	0818FL09	Khalas	AMR	OK	31.03.2023	AP 3Phase 3Wire				7030194	900-450/5	2.353	NA	Director/D	
B.1261	Border	SUB URBAN AMRITSAR	11KV	DS WEST DIVN. ASR	DS S/D CHOGAWAN	0818FL02	Brar	AMR	OK	31.03.2023	AP 3Phase 3Wire				8223616	900-450/5	2.632	NA	Director/D	
B.1262	Border	SUB URBAN AMRITSAR	11KV	DS WEST DIVN. ASR	DS S/D CHOGAWAN	0818FL05	Manawala	AMR	OK	31.03.2023	AP 3Phase 3Wire				8223444	900-450/5	2.688	NA	Director/D	
B.1263	Border	SUB URBAN AMRITSAR	11KV	DS WEST DIVN. ASR	DS S/D CHOGAWAN	0818FL20	11 KV KHALLA KALAN	AMR	OK	31.03.2023	AP 3Phase 3Wire				11114494	1200-600/5	2.957	NA	Director/D	
B.1264	Border	SUB URBAN AMRITSAR	11KV	DS WEST DIVN. ASR	DS S/D CHOGAWAN	0818FL11	Tapiala	AMR	OK	31.03.2023	AP 3Phase 3Wire				2067416	1200-600/5	2.970	NA	Director/D	
B.1265	Border	SUB URBAN AMRITSAR	11KV	DS WEST DIVN. ASR	DS S/D CHOGAWAN	0818FL08	Chawinda	AMR	OK	31.03.2023	AP 3Phase 3Wire				2066150	1200-600/5	3.006	NA	Director/D	
B.1266	Border	SUB URBAN AMRITSAR	11KV	DS WEST DIVN. ASR	DS S/D CHOGAWAN	0818FL22	UPS KOHALA	AMR	OK	31.03.2023	Category 5-U/PS				3955	1200-600/5	8.689	NA	Director/D	
B.1267	Border	SUB URBAN AMRITSAR	11KV	DS WEST DIVN. ASR	DS S/D CHOGAWAN	0818FL15	24 Hrs Bhullai	AMR	OK	31.03.2023	Category 5-U/PS				9261865	1200-600/5	9.751	NA	Director/D	
B.1268	Border	SUB URBAN AMRITSAR	11KV	DS WEST DIVN. ASR	DS S/D CHOGAWAN	0818FL17	24 Hrs Kohali	AMR	OK	31.03.2023	Category 5-U/PS				2067558	900-450/5	11.734	NA	Director/D	
B.1269	Border	SUB URBAN AMRITSAR	11KV	DS WEST DIVN. ASR	DS S/D CHOGAWAN	0818FL19	11 KV MADOKKY UPS	AMR	OK	31.03.2023	Category 5-U/PS				11114526	1200-600/5	13.244	NA	Director/D	
B.1270	Border	SUB URBAN AMRITSAR	11KV	DS WEST DIVN. ASR	DS S/D CHOGAWAN	0818FL13	Chogawan	AMR	OK	31.03.2023	Category 1				11114509	1200-600/5	15.537	NA	Director/D	
B.1271	Border	SUB URBAN AMRITSAR	11KV	DS WEST DIVN. ASR	DS S/D CHOGAWAN	0811FL05	AWAN LAKHA SINGH	AMR	OK	31.03.2023	AP 3Phase 3Wire				2066701	900-450/577/1-1	1.555	NA	Director/D	
B.1272	Border	SUB URBAN AMRITSAR	11KV	DS WEST DIVN. ASR	DS S/D CHOGAWAN	0811FL06	CHACK KAMAL KHAN	NON AMR	OK	31.03.2023	AP 3Phase 3Wire				36804	900-450/577/1-1	2.449	NA	Director/D	
B.1273	Border	SUB URBAN AMRITSAR	11KV	DS WEST DIVN. ASR	DS S/D CHOGAWAN	0811FL12	FALAY	AMR	OK	31.03.2023	Category 5-U/PS				1956085	900-450/577/1-1	9.438	NA	Director/D	
B.1274	Border	SUB URBAN AMRITSAR	11KV	DS WEST DIVN. ASR	DS S/D KHASSA	0830FL08	Chuk Mukand	AMR	OK	31.03.2023	AP 3Phase 3Wire				5437710	900-450/577/1-1	1.712	NA	Director/D	
B.1275	Border	SUB URBAN AMRITSAR	11KV	DS WEST DIVN. ASR	DS S/D KHASSA	0830FL09	Dhatal	AMR	OK	31.03.2023	AP 3Phase 3Wire				8223380	900-450/577/1-1	2.839	NA	Director/D	
B.1276	Border	SUB URBAN AMRITSAR	11KV	DS WEST DIVN. ASR	DS S/D KHASSA	0830FL1	Chn UPS	AMR	OK	31.03.2023	Category 5-U/PS				7030198	1200/577/1-1	13.916	NA	Director/D	
B.1277	Border	SUB URBAN AMRITSAR	11KV	DS WEST DIVN. ASR	DS S/D KHASSA	0802FL13	MEHMOOD NAGAR	AMR	OK	31.03.2023	AP 3Phase 3Wire				6675991	900-450/577/1-1	1.242	NA	Director/D	
B.1278	Border	SUB URBAN AMRITSAR	11KV	DS WEST DIVN. ASR	DS S/D KHASSA	0802FL04	GHARINDA	AMR	OK	31.03.2023	AP 3Phase 3Wire				10283620	1200/577/1-1	4.068	NA	Director/D	
B.1279	Border	SUB URBAN AMRITSAR	11KV	DS WEST DIVN. ASR	DS S/D KHASSA	8802FL12	KOLOWAL	AMR	OK	31.03.2023	AP 3Phase 3Wire				4218667	900-450/577/1-1	1.789	NA	Director/D	
B.1280	Border	SUB URBAN AMRITSAR	11KV	DS WEST DIVN. ASR	DS S/D KHASSA	8802FL08	CHICHA	AMR	OK	31.03.2023	AP 3Phase 3Wire				2067565	1200/577/1-1	2.155	NA	Director/D	
B.1281	Border	SUB URBAN AMRITSAR	11KV	DS WEST DIVN. ASR	DS S/D KHASSA	8802FL05	Chhididan	AMR	OK	31.03.2023	AP 3Phase 3Wire				5342473	1200/577/1-1	2.220	NA	Director/D	
B.1282	Border	SUB URBAN AMRITSAR	11KV	DS WEST DIVN. ASR	DS S/D KHASSA	8802FL02	BHAKHNA	AMR	OK	31.03.2023	AP 3Phase 3Wire				6607248	900-450/577/1-1	2.252	NA	Director/D	
B.1283	Border	SUB URBAN AMRITSAR	11KV	DS WEST DIVN. ASR	DS S/D KHASSA	8802FL06	Boparal	AMR	OK	31.03.2023	AP 3Phase 3Wire				4181121	900-450/577/1-1	2.419	NA	Director/D	
B.1284	Border	SUB URBAN AMRITSAR	11KV	DS WEST DIVN. ASR	DS S/D KHASSA	8802FL03	HEIR	AMR	OK	31.03.2023	AP 3Phase 3Wire				2067213	1200/577/1-1	2.430	NA	Director/D	
B.1285	Border	SUB URBAN AMRITSAR	11KV	DS WEST DIVN. ASR	DS S/D KHASSA	8802FL11	Jogjeer	AMR	OK	31.03.2023	AP 3Phase 3Wire				6669557	1200/577/1-1	2.574	NA	Director/D	
B.1286	Border	SUB URBAN AMRITSAR	11KV	DS WEST DIVN. ASR	DS S/D KHASSA	8802FL09	MALLUWAL	AMR	OK	31.03.2023	Category 5-U/PS				11114507	1200/577/1-1	11.543	NA	Director/D	
B.1287	Border	SUB URBAN AMRITSAR	11KV	DS WEST DIVN. ASR	DS S/D KHASSA	8802FL10	PADHRI	AMR	OK	31.03.2023	Category 5-U/PS				7030218	900-450/577/1-1	13.076	NA	Director/D	
B.1288	Border	SUB URBAN AMRITSAR	11KV	DS WEST DIVN. ASR	DS S/D KHASSA	8802FL01	KHASSA	NON AMR	OK	31.03.2023	Category 1				7366723	1200/577/1-1	13.261	NA	Director/D	
B.1289	Border	SUB URBAN AMRITSAR	11KV	DS WEST DIVN. ASR	DS S/D KHASSA	0814FL13	THANE UPS	AMR	OK	31.03.2023	Category 5-U/PS				9261866	1200-600/5	9.751	NA	Director/D	
B.1290	Border	SUB URBAN AMRITSAR	11KV	DS WEST DIVN. ASR	DS S/D KHASSA	0814FL06	Kotli	AMR	OK	31.03.2023	AP 3Phase 3Wire				3266529	900-450/577/1-1	1.900	NA	Director/D	
B.1291	Border	SUB URBAN AMRITSAR	11KV	DS WEST DIVN. ASR	DS S/D KHASSA	0814FL09	11 KV FATEHPUR	AMR	OK	31.03.2023	AP 3Phase 3Wire				37113	900-450/577/1-1	1.490	NA	Director/D	
B.1292	Border	SUB URBAN AMRITSAR	11KV	DS WEST DIVN. ASR	DS S/D KHASSA	0814FL04	IBBAN	AMR	OK	31.03.2023	AP 3Phase 3Wire				2067527	1200-600/5	1.897	NA	Director/D	
B.1293	Border	SUB URBAN AMRITSAR	11KV	DS WEST DIVN. ASR	DS S/D KHASSA	0814FL01	Thande	AMR	OK	31.03.2023	AP 3Phase 3Wire				2067544	1200-600/5	3.098	NA	Director/D	
B.1294																				

S.No	Zone	Circle	Voltage (kVA)	Division (kVA)	Sub-Division (kVA)	Feeder ID	Feeder Name	Feeder Metering Status (Metered/unmetered/AMR/AMI)	Status of Meter (Functional/Non-Functional)	Metering Date	Date of last actual meter reading/communication	Feeder Type (Agr/Industrial/Mixed)	Status of Communication			Period from 01.04.2021 to 31.03.2022				Sales	Remarks (Source of data)
													% data received through automatically by feeder AMR/AMI	Number of hours when meter was unable to communicate in overall	Total Number of hours in the period	Meter S.No	CT/PT ratio	Import (kU)	Export (kU)		
B.1328	Border	SUB URBAN AMRITSAR	11KV	DS WEST DIVN. ASR	DS S/D LOPOKE	0817F06	CHAK ALA BAKSH	NON AMR	OK	31.03.2023		AP 3Phase 3Wire				2066991	900-450/5	2,015	NA	Director/D	
B.1329	Border	SUB URBAN AMRITSAR	11KV	DS WEST DIVN. ASR	DS S/D LOPOKE	0817F05	Dagdot	AMR	OK	31.03.2023		AP 3Phase 3Wire				9534187	900-450/5	2,411	NA	Director/D	
B.1330	Border	SUB URBAN AMRITSAR	11KV	DS WEST DIVN. ASR	DS S/D LOPOKE	0817F17	Thrit	AMR	OK	31.03.2023		AP 3Phase 3Wire				9534515	900-450/5	2,411	NA	Director/D	
B.1331	Border	SUB URBAN AMRITSAR	11KV	DS WEST DIVN. ASR	DS S/D LOPOKE	0817F11	Sudhwal	NON AMR	OK	31.03.2023		AP 3Phase 3Wire				2062385	900-450/5	2,714	NA	Director/D	
B.1332	Border	SUB URBAN AMRITSAR	11KV	DS WEST DIVN. ASR	DS S/D LOPOKE	0817F04	Sarangra	AMR	OK	31.03.2023		AP 3Phase 3Wire				2065631	900-450/5	3,175	NA	Director/D	
B.1333	Border	SUB URBAN AMRITSAR	11KV	DS WEST DIVN. ASR	DS S/D LOPOKE	0817F01	Rania	NON AMR	OK	31.03.2023		AP 3Phase 3Wire				2067413	900-450/5	3,460	NA	Director/D	
B.1334	Border	SUB URBAN AMRITSAR	11KV	DS WEST DIVN. ASR	DS S/D LOPOKE	0817F24	URBAN KAKKAR	NON AMR	OK	31.03.2023		Category 1				4497	900-450/5	4,352	NA	Director/D	
B.1335	Border	SUB URBAN AMRITSAR	11KV	DS WEST DIVN. ASR	DS S/D LOPOKE	0817F22	LALIAN UPS	NON AMR	OK	31.03.2023		Category 5-UPS				3515	900-450/5	6,533	NA	Director/D	
B.1336	Border	SUB URBAN AMRITSAR	11KV	DS WEST DIVN. ASR	DS S/D LOPOKE	0817F14	24 Hrs Pandon	NON AMR	OK	31.03.2023		Category 5-UPS				8222443	900-450/5	6,866	NA	Director/D	
B.1337	Border	SUB URBAN AMRITSAR	11KV	DS WEST DIVN. ASR	DS S/D LOPOKE	0817F13	24 Hrs Vehrta	AMR	OK	31.03.2023		Category 5-UPS				2067909	900-450/5	6,103	NA	Director/D	
B.1338	Border	SUB URBAN AMRITSAR	11KV	DS. DIVN. AJNALA	DS S/D AJNALA	0836F10	11KV Kamripura	AMR	OK	31.03.2023		AP 3Phase 3Wire				5966	900-450/5/7/1-1	0,052	NA	Director/D	
B.1339	Border	SUB URBAN AMRITSAR	11KV	DS. DIVN. AJNALA	DS S/D AJNALA	0836F05	11KV Fethewal	AMR	OK	31.03.2023		AP 3Phase 3Wire				315.25	900-450/5	1,137	NA	Director/D	
B.1340	Border	SUB URBAN AMRITSAR	11KV	DS. DIVN. AJNALA	DS S/D AJNALA	0836F03	11KV KHANWAL	AMR	OK	31.03.2023		AP 3Phase 3Wire				11114487	900-450/5	1,301	NA	Director/D	
B.1341	Border	SUB URBAN AMRITSAR	11KV	DS. DIVN. AJNALA	DS S/D AJNALA	0836F09	11KV Majimlan	AMR	OK	31.03.2023		AP 3Phase 3Wire				4252	900-450/5/7/1-1	2,397	NA	Director/D	
B.1342	Border	SUB URBAN AMRITSAR	11KV	DS. DIVN. AJNALA	DS S/D AJNALA	0836F02	11KV BALARWAL	AMR	OK	31.03.2023		AP 3Phase 3Wire				15190693	900-450/5/7/1-1	2,839	NA	Director/D	
B.1343	Border	SUB URBAN AMRITSAR	11KV	DS. DIVN. AJNALA	DS S/D AJNALA	0836F01	11KV SARANGDEV	AMR	OK	31.03.2023		AP 3Phase 3Wire				15196084	900-450/5/7/1-1	2,918	NA	Director/D	
B.1344	Border	SUB URBAN AMRITSAR	11KV	DS. DIVN. AJNALA	DS S/D AJNALA	0836F08	11KV Jagwal	AMR	OK	31.03.2023		Category 5-UPS				2064675	900-450/5	4,031	NA	Director/D	
B.1345	Border	SUB URBAN AMRITSAR	11KV	DS. DIVN. AJNALA	DS S/D AJNALA	0836F07	11KV Grantgarh	AMR	OK	31.03.2023		Category 5-UPS				8222931	900-450/5	5,941	NA	Director/D	
B.1346	Border	SUB URBAN AMRITSAR	11KV	DS. DIVN. AJNALA	DS S/D AJNALA	0836F04	11KV CHAM DOGRA	AMR	OK	31.03.2023		Category 5-UPS				9140831	900-450/5	6,807	NA	Director/D	
B.1347	Border	SUB URBAN AMRITSAR	11KV	DS. DIVN. AJNALA	DS S/D AJNALA	0836F15	11KV Govt Hospital	NON AMR	OK	31.03.2023		Category 1				37105	1200-600/5	0,000	NA	Director/D	
B.1348	Border	SUB URBAN AMRITSAR	11KV	DS. DIVN. AJNALA	DS S/D AJNALA	0836F07	SUREPUR	AMR	OK	31.03.2023		AP 3Phase 3Wire				8223149	900-450/5/7/1-1	0,351	NA	Director/D	
B.1349	Border	SUB URBAN AMRITSAR	11KV	DS. DIVN. AJNALA	DS S/D AJNALA	0836F03	TALWANDI	NON AMR	OK	31.03.2023		AP 3Phase 3Wire				8223147	900-450/5/7/1-1	0,799	NA	Director/D	
B.1350	Border	SUB URBAN AMRITSAR	11KV	DS. DIVN. AJNALA	DS S/D AJNALA	0836F05	JACDEV	NON AMR	OK	31.03.2023		AP 3Phase 3Wire				11051965	1200-600/5	1,334	NA	Director/D	
B.1351	Border	SUB URBAN AMRITSAR	11KV	DS. DIVN. AJNALA	DS S/D AJNALA	0836F04	GURALA	NON AMR	OK	31.03.2023		AP 3Phase 3Wire				8223072	1200-600/5	1,390	NA	Director/D	
B.1352	Border	SUB URBAN AMRITSAR	11KV	DS. DIVN. AJNALA	DS S/D AJNALA	0836F17	Ran Nangar	AMR	OK	31.03.2023		AP 3Phase 3Wire				15193852	1200-600/5	1,453	NA	Director/D	
B.1353	Border	SUB URBAN AMRITSAR	11KV	DS. DIVN. AJNALA	DS S/D AJNALA	0836F12	11KV RAJAN	AMR	OK	31.03.2023		AP 3Phase 3Wire				12093351	1200-600/5	1,750	NA	Director/D	
B.1354	Border	SUB URBAN AMRITSAR	11KV	DS. DIVN. AJNALA	DS S/D AJNALA	0836F01	NANGAL	NON AMR	OK	31.03.2023		AP 3Phase 3Wire				8223458	1200-600/5	1,802	NA	Director/D	
B.1355	Border	SUB URBAN AMRITSAR	11KV	DS. DIVN. AJNALA	DS S/D AJNALA	0836F06	AMBKOTLI	AMR	OK	31.03.2023		AP 3Phase 3Wire				8223456	900-450/5/7/1-1	1,820	NA	Director/D	
B.1356	Border	SUB URBAN AMRITSAR	11KV	DS. DIVN. AJNALA	DS S/D AJNALA	0836F16	11KV Kotli Krotana	AMR	OK	31.03.2023		AP 3Phase 3Wire				3407	1200-600/5	1,900	NA	Director/D	
B.1357	Border	SUB URBAN AMRITSAR	11KV	DS. DIVN. AJNALA	DS S/D AJNALA	0836F08	DHARWAL	AMR	OK	31.03.2023		AP 3Phase 3Wire				8223459	900-450/5/7/1-1	1,960	NA	Director/D	
B.1358	Border	SUB URBAN AMRITSAR	11KV	DS. DIVN. AJNALA	DS S/D AJNALA	0836F14	KRHR	NON AMR	OK	31.03.2023		AP 3Phase 3Wire				2068087	900-450/5/7/1-1	2,163	NA	Director/D	
B.1359	Border	SUB URBAN AMRITSAR	11KV	DS. DIVN. AJNALA	DS S/D AJNALA	0836F10	PANDRI	NON AMR	OK	31.03.2023		AP 3Phase 3Wire				2065691	900-450/5/7/1-1	2,262	NA	Director/D	
B.1360	Border	SUB URBAN AMRITSAR	11KV	DS. DIVN. AJNALA	DS S/D AJNALA	0836F21	Harrar Kalan	NON AMR	OK	31.03.2023		Category 5-UPS				5397	1200-600/5	3,233	NA	Director/D	
B.1361	Border	SUB URBAN AMRITSAR	11KV	DS. DIVN. AJNALA	DS S/D AJNALA	0836F11	LAKHWAL	NON AMR	OK	31.03.2023		Category 5-UPS				8223460	900-450/5/7/1-1	4,756	NA	Director/D	
B.1362	Border	SUB URBAN AMRITSAR	11KV	DS. DIVN. AJNALA	DS S/D AJNALA	0836F20	Gujarpura	AMR	OK	31.03.2023		Category 5-UPS				4499	1200-600/5	6,117	NA	Director/D	
B.1363	Border	SUB URBAN AMRITSAR	11KV	DS. DIVN. AJNALA	DS S/D AJNALA	0836F18	City-11	AMR	OK	31.03.2023		Category 1				73165981	1200-600/5	8,166	NA	Director/D	
B.1364	Border	SUB URBAN AMRITSAR	11KV	DS. DIVN. AJNALA	DS S/D AJNALA	0836F19	Bhala Hari Singh	NON AMR	OK	31.03.2023		Category 5-UPS				8223457	1200-600/5	8,470	NA	Director/D	
B.1365	Border	SUB URBAN AMRITSAR	11KV	DS. DIVN. AJNALA	DS S/D AJNALA	0836F09	GUJAPTER	NON AMR	OK	31.03.2023		Category 5-UPS				8223457	1200-600/5	8,675	NA	Director/D	
B.1366	Border	SUB URBAN AMRITSAR	11KV	DS. DIVN. AJNALA	DS S/D AJNALA	0836F02	City-11	NON AMR	OK	31.03.2023		Category 1				12093543	900-450/5/7/1-1	8,981	NA	Director/D	
B.1367	Border	SUB URBAN AMRITSAR	11KV	DS. DIVN. AJNALA	DS S/D AJNALA	0836F13	city-1	AMR	OK	31.03.2023		Category 1				66072026	900-450/5/7/1-1	12,411	NA	Director/D	
B.1368	Border	SUB URBAN AMRITSAR	11KV	DS. DIVN. AJNALA	DS S/D AJNALA	0836F19	Rampura	AMR	OK	31.03.2023		AP 3Phase 3Wire				4232	1200-600/5	1,228	NA	Director/D	
B.1369	Border	SUB URBAN AMRITSAR	11KV	DS. DIVN. AJNALA	DS S/D AJNALA	0836F17	SANGRA	AMR	OK	31.03.2023		AP 3Phase 3Wire				6740992	1200-600/5	1,321	NA	Director/D	
B.1370	Border	SUB URBAN AMRITSAR	11KV	DS. DIVN. AJNALA	DS S/D AJNALA	0836F01	SALEM PURA	AMR	OK	31.03.2023		AP 3Phase 3Wire				2067201	1200-600/5	1,607	NA	Director/D	
B.1371	Border	SUB URBAN AMRITSAR	11KV	DS. DIVN. AJNALA	DS S/D AJNALA	0836F18	Mehlawala	AMR	OK	31.03.2023		AP 3Phase 3Wire				16198448	1200-600/5	1,775	NA	Director/D	
B.1372	Border	SUB URBAN AMRITSAR	11KV	DS. DIVN. AJNALA	DS S/D AJNALA	0836F03	BHALAPIND	NON AMR	OK	31.03.2023		AP 3Phase 3Wire				2067322	1200-600/5	1,884	NA	Director/D	
B.1373	Border	SUB URBAN AMRITSAR	11KV	DS. DIVN. AJNALA	DS S/D AJNALA	0836F20	Dalam	AMR	OK	31.03.2023		Category 5-UPS				4494	1200-600/5	4,602	NA	Director/D	
B.1374	Border	SUB URBAN AMRITSAR	11KV	DS. DIVN. AJNALA	DS S/D AJNALA	0836F13	MEHLAN WALA UPS	AMR	OK	31.03.2023		Category 5-UPS				1116744	1200-600/5	6,010	NA	Director/D	
B.1375	Border	SUB URBAN AMRITSAR	11KV	DS. DIVN. AJNALA	DS S/D AJNALA	0836F17	11KV UPS	AMR	OK	31.03.2023		Category 5-UPS				42124	1200-600/5	8,066	NA	Director/D	
B.1376	Border	SUB URBAN AMRITSAR	11KV	DS. DIVN. AJNALA	DS S/D AJNALA	0836F03	RAPUR	AMR	OK	31.03.2023		Category 5-UPS				2067107	900-450/5	1,263	NA	Director/D	
B.1377	Border	SUB URBAN AMRITSAR	11KV	DS. DIVN. AJNALA	DS S/D AJNALA	0812F05	SHERPUR	NON AMR	OK	31.03.2023		Category 4				2067913	900-450/5	1,285	NA	Director/D	
B.1378	Border	SUB URBAN AMRITSAR	11KV	DS. DIVN. AJNALA	DS S/D AJNALA	0812F06	SADOGAI	NON AMR	OK	31.03.2023		AP 3Phase 3Wire				2066790	900-450/5	1,387	NA	Director/D	
B.1379	Border	SUB URBAN AMRITSAR	11KV	DS. DIVN. AJNALA	DS S/D AJNALA	0812F08	MOTLA	NON AMR	OK	31.03.2023		AP 3Phase 3Wire				7042854	900-450/5	1,622	NA	Director/D	
B.1380	Border	SUB URBAN AMRITSAR	11KV	DS. DIVN. AJNALA	DS S/D AJNALA	0812F10	SARANGDEV	AMR	OK	31.03.2023		Category 5-UPS				4211028	900-450/5	9,625	NA	Director/D	
B.1381	Border	SUB URBAN AMRITSAR	11KV	DS. DIVN. AJNALA	DS S/D JASTARWAL	0812F02	BOY BHLUR	AMR	OK	31.03.2023		Category 4				2067912	900-450/5	1,132	NA	Director/D	
B.1382	Border	SUB URBAN AMRITSAR	11KV	DS. DIVN. AJNALA	DS S/D JASTARWAL	F117D812	Chann Ghaga	AMR	OK	31.03.2023		AP 3Phase 3Wire				2348	900-450/5	0,983	NA	Director/D	
B.1383	Border	SUB URBAN AMRITSAR	11KV	DS. DIVN. AJNALA	DS S/D JASTARWAL	0812F04	JASRAHOOR \	AMR	OK	31.03.2023											

S.No	Zone	Circle	Voltage Level (kVA)	Division (kVA)	Sub-Division (kVA)	Feeder ID	Feeder Name	Feeder Metering Status (Metered/unmetered/AMR/AMI)	Status of Meter (Functional/Non-Functional)	Metering Date (Date of last actual meter reading/communication)	Feeder Type (Agr/Industrial/Mixed)	Status of Communication			Period from 01.04.2021 to 31.03.2022			Sales	Remarks (Source of data)
												% Data received through automatically if feeder AMR/AMI	Number of hours when meter was unable to communicate in period	Total Number of hours in the period	Meter S.No	CT/PT ratio	Import (kWh)		
B.1425	Border	SUB URBAN AMRITSAR	11KV	DS. DIVN. AJNALA	DS S/D RAMDASS	0807FL02	RAMDASS BOP	AMR	OK	31.03.2023	Category 4				2047063	1200-600/5	0.952	NA	Director/D
B.1426	Border	SUB URBAN AMRITSAR	11KV	DS. DIVN. AJNALA	DS S/D RAMDASS	0807FL03	JASSAR	AMR	OK	31.03.2023	AP 3Phase 3Wire				6740782	1200-600/5	0.956	NA	Director/D
B.1427	Border	SUB URBAN AMRITSAR	11KV	DS. DIVN. AJNALA	DS S/D RAMDASS	0807FL14	KIRULANJ	AMR	OK	31.03.2023	AP 3Phase 3Wire				2047068	1200-600/5	0.992	NA	Director/D
B.1428	Border	SUB URBAN AMRITSAR	11KV	DS. DIVN. AJNALA	DS S/D RAMDASS	0807FL18	Lohwalwal	AMR	OK	31.03.2023	AP 3Phase 3Wire				2047117	1200-600/5	1.207	NA	Director/D
B.1429	Border	SUB URBAN AMRITSAR	11KV	DS. DIVN. AJNALA	DS S/D RAMDASS	0807FL09	GONEWALA	AMR	OK	31.03.2023	AP 3Phase 3Wire				9153365	1200-600/5	1.293	NA	Director/D
B.1430	Border	SUB URBAN AMRITSAR	11KV	DS. DIVN. AJNALA	DS S/D RAMDASS	0807FL06	SINGHPURA	AMR	OK	31.03.2023	AP 3Phase 3Wire				2062764	1200-600/5	1.468	NA	Director/D
B.1431	Border	SUB URBAN AMRITSAR	11KV	DS. DIVN. AJNALA	DS S/D RAMDASS	0807FL05	JATTA	AMR	OK	31.03.2023	AP 3Phase 3Wire				12527375	1200-600/5	1.505	NA	Director/D
B.1432	Border	SUB URBAN AMRITSAR	11KV	DS. DIVN. AJNALA	DS S/D RAMDASS	0807FL12	KATLA	AMR	OK	31.03.2023	AP 3Phase 3Wire				5463612	1200-600/5	1.557	NA	Director/D
B.1433	Border	SUB URBAN AMRITSAR	11KV	DS. DIVN. AJNALA	DS S/D RAMDASS	0807FL07	PASSHA	AMR	OK	31.03.2023	AP 3Phase 3Wire				2067567	1200-600/5	1.566	NA	Director/D
B.1434	Border	SUB URBAN AMRITSAR	11KV	DS. DIVN. AJNALA	DS S/D RAMDASS	0807FL04	NANGAL SOHAL	AMR	OK	31.03.2023	AP 3Phase 3Wire				2068755	1200-600/5	1.723	NA	Director/D
B.1435	Border	SUB URBAN AMRITSAR	11KV	DS. DIVN. AJNALA	DS S/D RAMDASS	0807FL08	THOBA	AMR	OK	31.03.2023	AP 3Phase 3Wire				2047181	1200-600/5	1.870	NA	Director/D
B.1436	Border	SUB URBAN AMRITSAR	11KV	DS. DIVN. AJNALA	DS S/D RAMDASS	0807FL10	PABARALI	AMR	OK	31.03.2023	AP 3Phase 3Wire				7309553	1200-600/5	2.148	NA	Director/D
B.1437	Border	SUB URBAN AMRITSAR	11KV	DS. DIVN. AJNALA	DS S/D RAMDASS	0807FL11	KOTGURBAX	AMR	OK	31.03.2023	Category 5-UPS				6669361	1200-600/5	5.188	NA	Director/D
B.1438	Border	SUB URBAN AMRITSAR	11KV	DS. DIVN. AJNALA	DS S/D RAMDASS	0807FL16	Pandori UPS	AMR	OK	31.03.2023	Category 5-UPS				7315273	1200-600/5	6.156	NA	Director/D
B.1439	Border	SUB URBAN AMRITSAR	11KV	DS. DIVN. AJNALA	DS S/D RAMDASS	0807FL19	Shampur UPS	AMR	OK	31.03.2023	Category 5-UPS				4095	1200-600/5	6.207	NA	Director/D
B.1440	Border	SUB URBAN AMRITSAR	11KV	DS. DIVN. AJNALA	DS S/D RAMDASS	0807FL01	RAMDAS	AMR	OK	31.03.2023	Category 1				1209348	1200-600/5	6.405	NA	Director/D
B.1441	Border	SUB URBAN AMRITSAR	11KV	DS. DIVN. AJNALA	DS S/D RAMDASS	0807FL13	AWAN	AMR	OK	31.03.2023	Category 5-UPS				5390833	1200-600/5	10.428	NA	Director/D
B.1442	Border	SUB URBAN AMRITSAR	11KV	DS. DIVN. AJNALA	DS S/D FATEHGARH CHURIAN	8803FL16	KOTLA SADDAR	AMR	OK	31.03.2023	AP 3Phase 3Wire				7030181	200-100/5-5	1.350	NA	Director/D
B.1443	Border	SUB URBAN AMRITSAR	11KV	DS. DIVN. AJNALA	DS S/D FATEHGARH CHURIAN	8803FL05	SUDDAR	AMR	OK	31.03.2023	AP 3Phase 3Wire				2067420	200-100/5-5	1.739	NA	Director/D
B.1444	Border	SUB URBAN AMRITSAR	11KV	DS. DIVN. AJNALA	DS S/D FATEHGARH CHURIAN	8803FL18	TALWANDI NAHAR	AMR	OK	31.03.2023	AP 3Phase 3Wire				4179691	200-100/5-5	2.955	NA	Director/D
B.1445	Border	SUB URBAN AMRITSAR	11KV	DS. DIVN. AJNALA	DS S/D FATEHGARH CHURIAN	0839FL02	Kandwal	AMR	OK	31.03.2023	AP 3Phase 3Wire				1463	900-450/577/1-1	2.024	NA	Director/D
B.1446	Border	SUB URBAN AMRITSAR	11KV	DS. DIVN. AJNALA	DS S/D FATEHGARH CHURIAN	0839FL08	Pathan Nagal	NON AMR	OK	31.03.2023	Category 5-UPS				44933	900-450/577/1-1	6.845	NA	Director/D
B.1447	Border	SUB URBAN AMRITSAR	11KV	DS. DIVN. AJNALA	DS S/D FATEHGARH CHURIAN	0810FL11	Longmahal	AMR	OK	31.03.2023	AP 3Phase 3Wire				2068056	900-450/577/1-1	1.290	NA	Director/D
B.1448	Border	SUB URBAN AMRITSAR	11KV	DS. DIVN. AJNALA	DS S/D FATEHGARH CHURIAN	0810FL14	Sangana	AMR	OK	31.03.2023	AP 3Phase 3Wire				1709	900-450/577/1-1	1.547	NA	Director/D
B.1449	Border	SUB URBAN AMRITSAR	11KV	DS. DIVN. AJNALA	DS S/D FATEHGARH CHURIAN	0810FL12	Mohan Bhandarian	AMR	OK	31.03.2023	AP 3Phase 3Wire				15194679	900-450/577/1-1	1.673	NA	Director/D
B.1450	Border	SUB URBAN AMRITSAR	11KV	DS. DIVN. AJNALA	DS S/D FATEHGARH CHURIAN	0810FL05	NASSAR	AMR	OK	31.03.2023	AP 3Phase 3Wire				5345130	900-450/577/1-1	1.795	NA	Director/D
B.1451	Border	SUB URBAN AMRITSAR	11KV	DS. DIVN. AJNALA	DS S/D FATEHGARH CHURIAN	0810FL09	MUKAM	AMR	OK	31.03.2023	AP 3Phase 3Wire				9534541	900-450/577/1-1	1.798	NA	Director/D
B.1452	Border	SUB URBAN AMRITSAR	11KV	DS. DIVN. AJNALA	DS S/D FATEHGARH CHURIAN	0810FL13	BHUREGILL	AMR	OK	31.03.2023	AP 3Phase 3Wire				37030	900-450/577/1-1	1.896	NA	Director/D
B.1453	Border	SUB URBAN AMRITSAR	11KV	DS. DIVN. AJNALA	DS S/D FATEHGARH CHURIAN	0810FL08	HELLER	AMR	OK	31.03.2023	AP 3Phase 3Wire				8223071	900-450/577/1-1	1.939	NA	Director/D
B.1454	Border	SUB URBAN AMRITSAR	11KV	DS. DIVN. AJNALA	DS S/D FATEHGARH CHURIAN	0810FL03	DIA BHARANG	AMR	OK	31.03.2023	AP 3Phase 3Wire				9140944	900-450/577/1-1	1.975	NA	Director/D
B.1455	Border	SUB URBAN AMRITSAR	11KV	DS. DIVN. AJNALA	DS S/D FATEHGARH CHURIAN	0810FL01	KHANDWAL	AMR	OK	31.03.2023	AP 3Phase 3Wire				5342130	900-450/577/1-1	2.446	NA	Director/D
B.1456	Border	SUB URBAN AMRITSAR	11KV	DS. DIVN. AJNALA	DS S/D FATEHGARH CHURIAN	0810FL05	NANKE	AMR	OK	31.03.2023	AP 3Phase 3Wire				9340941	900-450/577/1-1	2.556	NA	Director/D
B.1457	Border	SUB URBAN AMRITSAR	11KV	DS. DIVN. AJNALA	DS S/D FATEHGARH CHURIAN	0810FL04	GORE NANGAL	AMR	OK	31.03.2023	Category 3Wire				822855	900-450/577/1-1	2.686	NA	Director/D
B.1458	Border	SUB URBAN AMRITSAR	11KV	DS. DIVN. AJNALA	DS S/D FATEHGARH CHURIAN	0810015	Makwali UPS	AMR	OK	31.03.2023	Category 5-UPS				3534	900-450/577/1-1	5.787	NA	Director/D
B.1459	Border	SUB URBAN AMRITSAR	11KV	DS. DIVN. AJNALA	DS S/D FATEHGARH CHURIAN	0810FL10	Dyalpura	AMR	OK	31.03.2023	Category 5-UPS				8223075	900-450/577/1-1	6.198	NA	Director/D
B.1460	Border	SUB URBAN AMRITSAR	11KV	DS. DIVN. AJNALA	DS S/D FATEHGARH CHURIAN	0810FL07	24 HOURS MATENANGAL	AMR	OK	31.03.2023	Category 5-UPS				5295854	900-450/577/1-1	6.776	NA	Director/D
B.1461	Border	SUB URBAN AMRITSAR	11KV	DS. DIVN. AJNALA	DS S/D FATEHGARH CHURIAN	0810FL06	24 HOURS KHANDWAL	AMR	OK	31.03.2023	Category 5-UPS				9340251	900-450/577/1-1	9.186	NA	Director/D
B.1462	Border	SUB URBAN AMRITSAR	11KV	DS. DIVN. AJNALA	DS S/D FATEHGARH CHURIAN	0809FL02	KANDWAL	AMR	OK	31.03.2023	AP 3Phase 3Wire				2066615	1200-600/5	0.980	NA	Director/D
B.1463	Border	SUB URBAN AMRITSAR	11KV	DS. DIVN. AJNALA	DS S/D FATEHGARH CHURIAN	0809FL12	MASHI NANGAL	AMR	OK	31.03.2023	AP 3Phase 3Wire				23225	1200-600/5	1.172	NA	Director/D
B.1464	Border	SUB URBAN AMRITSAR	11KV	DS. DIVN. AJNALA	DS S/D FATEHGARH CHURIAN	0809FL17	Gurdwara Baba Bhadur Singh	AMR	OK	31.03.2023	AP 3Phase 3Wire				1234567	900-450/577/1-1	1.284	NA	Director/D
B.1465	Border	SUB URBAN AMRITSAR	11KV	DS. DIVN. AJNALA	DS S/D FATEHGARH CHURIAN	FL180809	Sangarpura Mandi	AMR	OK	31.03.2023	AP 3Phase 3Wire				123456	1200-600/5	1.285	NA	Director/D
B.1466	Border	SUB URBAN AMRITSAR	11KV	DS. DIVN. AJNALA	DS S/D FATEHGARH CHURIAN	0809FL06	KOTLI	AMR	OK	31.03.2023	AP 3Phase 3Wire				9154131	900-450/577/1-1	1.312	NA	Director/D
B.1467	Border	SUB URBAN AMRITSAR	11KV	DS. DIVN. AJNALA	DS S/D FATEHGARH CHURIAN	0809FL20	11 Hour Supp Sakander	NON AMR	OK	31.03.2023	Category 1				2067491	1200-600/5	0.425	NA	Director/D
B.1468	Border	SUB URBAN AMRITSAR	11KV	DS. DIVN. AJNALA	DS S/D FATEHGARH CHURIAN	0809FL01	KAMALPURA	AMR	OK	31.03.2023	AP 3Phase 3Wire				2066856	1200-600/5	1.549	NA	Director/D
B.1469	Border	SUB URBAN AMRITSAR	11KV	DS. DIVN. AJNALA	DS S/D FATEHGARH CHURIAN	0809FL04	PULTI	AMR	OK	31.03.2023	AP 3Phase 3Wire				6745333	1200-600/5	1.553	NA	Director/D
B.1470	Border	SUB URBAN AMRITSAR	11KV	DS. DIVN. AJNALA	DS S/D FATEHGARH CHURIAN	FL180809	Khatral Khurd	AMR	OK	31.03.2023	AP 3Phase 3Wire				1234567	900-450/577/1-1	1.790	NA	Director/D
B.1471	Border	SUB URBAN AMRITSAR	11KV	DS. DIVN. AJNALA	DS S/D FATEHGARH CHURIAN	0809FL08	TERA	NON AMR	OK	31.03.2023	AP 3Phase 3Wire				2067545	900-450/577/1-1	1.907	NA	Director/D
B.1472	Border	SUB URBAN AMRITSAR	11KV	DS. DIVN. AJNALA	DS S/D FATEHGARH CHURIAN	0809FL13	BATH	AMR	OK	31.03.2023	AP 3Phase 3Wire				2067548	1200-600/5	0.966	NA	Director/D
B.1473	Border	SUB URBAN AMRITSAR	11KV	DS. DIVN. AJNALA	DS S/D FATEHGARH CHURIAN	0809FL03	HANDER	AMR	OK	31.03.2023	AP 3Phase 3Wire				2067967	1200-600/5	2.085	NA	Director/D
B.1474	Border	SUB URBAN AMRITSAR	11KV	DS. DIVN. AJNALA	DS S/D FATEHGARH CHURIAN	0809FL05	VACHNOA	AMR	OK	31.03.2023	AP 3Phase 3Wire				5295994	1200-600/5	2.136	NA	Director/D
B.1475	Border	SUB URBAN AMRITSAR	11KV	DS. DIVN. AJNALA	DS S/D FATEHGARH CHURIAN	0809FL11	CHETANPURA	AMR	OK	31.03.2023	Category 5-UPS				10273776	1200-600/5	2.504	NA	Director/D
B.1476	Border	SUB URBAN AMRITSAR	11KV	DS. DIVN. AJNALA	DS S/D FATEHGARH CHURIAN	0809FL09	SANGTPURA	AMR	OK	31.03.2023	Category 5-UPS				6675949	900-450/577/1-1	9.708	NA	Director/D
B.1477	Border	SUB URBAN AMRITSAR	11KV	DS. DIVN. AJNALA	DS S/D FATEHGARH CHURIAN	0809FL10	QUAMPURA	NON AMR	OK	31.03.2023	Category 5-UPS				2068042	900-450/577/1-1	10.755	NA	Director/D
B.1478	Border	TARN TARAN	11KV	DS CITY DIVN. TARN TARAN	DS S/D TARN TARAN	C302FL02	CITY 2 HOSPITAL	AMR	OK	31.03.2023	Category 1				9340550	1200-600/5	0.884	NA	Director/D
B.1479	Border	TARN TARAN	11KV	DS CITY DIVN. TARN TARAN	DS S/D TARN TARAN	C302FL07	CITY 3	AMR	OK	31.03.2023	Category 1				2993727	1200-600/5	8.730	NA	Director/D
B.1480	Border	TARN TARAN	11KV	DS CITY DIVN. TARN TARAN	DS S/D TARN TARAN	C302FL13	CITY 4	AMR	OK	31.03.2023	Category 1				8222721	1200-600/5	9.859		

S.No	Zone	Circle	Voltage Level (kVA)	Division (kVA)	Sub-Division (kVA)	Feeder ID	Feeder Name	Feeder Metering Status (Metered/unmetered/AMR/AMI)	Status of Meter (Functional/Non-Functional)	Metering Date (Date of last actual meter reading/communication)	Feeder Type (Agr/Industrial/Mixed)	Status of Communication			Period from 01.04.2021 to 31.03.2022				Sales	Remarks (Source of data)
												% data received through automatically if feeder AMR/AMI	Number of hours when meter was unable to communicate in overall	Total Number of hours in the period	Meter S.No	CT/PT ratio	Import (kU)	Export (kU)		
B.1522	Border	TARN TARAN	11KV	DS CITY DIVN. TARN TARAS S/D GOHALWAR		0906F05	RATOUL	AMR	OK	31.03.2023	AP 3Phase 3Wire				2046449	1200-600/5	2.236	NA	Director/D	
B.1523	Border	TARN TARAN	11KV	DS CITY DIVN. TARN TARAS S/D GOHALWAR		0906FL12	BEHLA	AMR	OK	31.03.2023	AP 3Phase 3Wire				2066262	1200-600/5	2.365	NA	Director/D	
B.1524	Border	TARN TARAN	11KV	DS CITY DIVN. TARN TARAS S/D GOHALWAR		0906FL20	Beliha ups	NON AMR	OK	31.03.2023	Category 5-UPS				5724	1200-600/5	3.159	NA	Director/D	
B.1525	Border	TARN TARAN	11KV	DS CITY DIVN. TARN TARAS S/D GOHALWAR		0933F01	KOCHER	NON AMR	OK	31.03.2023	Category 1				887645003	900-450/5	2.585	NA	Director/D	
B.1526	Border	TARN TARAN	11KV	DS CITY DIVN. TARN TARAS S/D GOHALWAR		0933F07	KHARA	NON AMR	OK	31.03.2023	AP 3Phase 3Wire				5437742	900-450/5	2.228	NA	Director/D	
B.1527	Border	TARN TARAN	11KV	DS CITY DIVN. TARN TARAS S/D GOHALWAR		0933F02	KOT DASANDI MAL	NON AMR	OK	31.03.2023	AP 3Phase 3Wire				5437706	900-450/5	2.243	NA	Director/D	
B.1528	Border	TARN TARAN	11KV	DS CITY DIVN. TARN TARAS S/D GOHALWAR		0933F03	PANDORI RAMANA	NON AMR	OK	31.03.2023	AP 3Phase 3Wire				5437703	900-450/5	2.264	NA	Director/D	
B.1529	Border	TARN TARAN	11KV	DS CITY DIVN. TARN TARAS S/D GOHALWAR		0933F04	PANDORI SIDHWAN	NON AMR	OK	31.03.2023	AP 3Phase 3Wire				5437739	900-450/5	2.566	NA	Director/D	
B.1530	Border	TARN TARAN	11KV	DS CITY DIVN. TARN TARAS S/D GOHALWAR		0933F10	KOTLI	NON AMR	OK	31.03.2023	AP 3Phase 3Wire				887645003	900-450/5	2.585	NA	Director/D	
B.1531	Border	TARN TARAN	11KV	DS CITY DIVN. TARN TARAS S/D GOHALWAR		0933F08	FIBRE KOCHER	NON AMR	OK	31.03.2023	Category 1				12092496	900-450/5	4.555	NA	Director/D	
B.1532	Border	TARN TARAN	11KV	DS CITY DIVN. TARN TARAS S/D GOHALWAR		0933F17	DUNAR FOOD	NON AMR	OK	31.03.2023	Category 2				11116752	900-450/5	4.616	NA	Director/D	
B.1533	Border	TARN TARAN	11KV	DS CITY DIVN. TARN TARAS S/D GOHALWAR		0933F05	24 HRS UPS	NON AMR	OK	31.03.2023	Category 5-UPS				9154438	900-450/5	11.294	NA	Director/D	
B.1534	Border	TARN TARAN	11KV	DS CITY DIVN. TARN TARAS S/D GOHALWAR		0933F06	INDEPENDENT FEEDER	NON AMR	OK	31.03.2023	Category 4				11116865	900-450/5	11.380	NA	Director/D	
B.1535	Border	TARN TARAN	11KV	DS CITY DIVN. TARN TARAS S/D MANOCHAHAL		0946FL14	PALASOUR KHURD	AMR	OK	31.03.2023	AP 3Phase 3Wire				23643	900-450/5	2.488	NA	Director/D	
B.1536	Border	TARN TARAN	11KV	DS CITY DIVN. TARN TARAS S/D MANOCHAHAL		0933F02	PALASOUR	AMR	OK	31.03.2023	AP 3Phase 3Wire				2067949	900-450/5	3.020	NA	Director/D	
B.1537	Border	TARN TARAN	11KV	DS CITY DIVN. TARN TARAS S/D MANOCHAHAL		0946FL04	Alina Mallia	AMR	OK	31.03.2023	AP 3Phase 3Wire				159033	900-450/577/1-1-1	0.882	NA	Director/D	
B.1538	Border	TARN TARAN	11KV	DS CITY DIVN. TARN TARAS S/D MANOCHAHAL		0946FL06	KAMBOO AP	AMR	OK	31.03.2023	AP 3Phase 3Wire				197911	900-450/577/1-1-1	0.927	NA	Director/D	
B.1539	Border	TARN TARAN	11KV	DS CITY DIVN. TARN TARAS S/D MANOCHAHAL		0946FL05	Baba Bir Singh	NON AMR	OK	31.03.2023	Category 5-UPS				4359	900-450/577/1-1-1	1.474	NA	Director/D	
B.1540	Border	TARN TARAN	11KV	DS CITY DIVN. TARN TARAS S/D MANOCHAHAL		0946FL02	Jhanka AP	AMR	OK	31.03.2023	AP 3Phase 3Wire				198032	900-450/577/1-1-1	2.215	NA	Director/D	
B.1541	Border	TARN TARAN	11KV	DS CITY DIVN. TARN TARAS S/D MANOCHAHAL		0946FL03	Bhaini Rural	AMR	OK	31.03.2023	AP 3Phase 3Wire				198071	900-450/577/1-1-1	2.309	NA	Director/D	
B.1542	Border	TARN TARAN	11KV	DS CITY DIVN. TARN TARAS S/D MANOCHAHAL		0946FL01	Jhanka UPS	AMR	OK	31.03.2023	Category 5-UPS				198025	900-450/577/1-1-1	6.521	NA	Director/D	
B.1543	Border	TARN TARAN	11KV	DS CITY DIVN. TARN TARAS S/D MANOCHAHAL		0916FL11	SHEKH NEW + OLD	AMR	OK	31.03.2023	AP 3Phase 3Wire				2066265	1200-600/5	0.000	NA	Director/D	
B.1544	Border	TARN TARAN	11KV	DS CITY DIVN. TARN TARAS S/D MANOCHAHAL		0916FL05	DALEKE	AMR	OK	31.03.2023	AP 3Phase 3Wire				8223010	1200-600/5	1.438	NA	Director/D	
B.1545	Border	TARN TARAN	11KV	DS CITY DIVN. TARN TARAS S/D MANOCHAHAL		0916FL03	MANOCHAHAL R	AMR	OK	31.03.2023	AP 3Phase 3Wire				82223006	900-450/5	1.669	NA	Director/D	
B.1546	Border	TARN TARAN	11KV	DS CITY DIVN. TARN TARAS S/D MANOCHAHAL		0916FL15	NEW MANOCHAHAL	AMR	OK	31.03.2023	AP 3Phase 3Wire				4669	1200-600/5	1.677	NA	Director/D	
B.1547	Border	TARN TARAN	11KV	DS CITY DIVN. TARN TARAS S/D MANOCHAHAL		0916FL07	SAKHRA	NON AMR	OK	31.03.2023	AP 3Phase 3Wire				8223215	1200-600/5	2.367	NA	Director/D	
B.1548	Border	TARN TARAN	11KV	DS CITY DIVN. TARN TARAS S/D MANOCHAHAL		0916FL08	GORKHA	AMR	OK	31.03.2023	AP 3Phase 3Wire				2067349	900-450/5	2.670	NA	Director/D	
B.1549	Border	TARN TARAN	11KV	DS CITY DIVN. TARN TARAS S/D MANOCHAHAL		0916FL04	JHAMKA	AMR	OK	31.03.2023	AP 3Phase 3Wire				9534506	1200-600/5	2.814	NA	Director/D	
B.1550	Border	TARN TARAN	11KV	DS CITY DIVN. TARN TARAS S/D MANOCHAHAL		0916FL12	MANOCHAHAL NIKE NEW +OLD	AMR	OK	31.03.2023	AP 3Phase 3Wire				8222681	1200-600/5	3.313	NA	Director/D	
B.1551	Border	TARN TARAN	11KV	DS CITY DIVN. TARN TARAS S/D MANOCHAHAL		0916FL01	JEOBALA-GILL	AMR	OK	31.03.2023	AP 3Phase 3Wire				8222684	900-450/5	3.923	NA	Director/D	
B.1552	Border	TARN TARAN	11KV	DS CITY DIVN. TARN TARAS S/D MANOCHAHAL		0916FL16	Wullipal	AMR	OK	31.03.2023	Category 5-UPS				4190	1200-600/5	5.539	NA	Director/D	
B.1553	Border	TARN TARAN	11KV	DS CITY DIVN. TARN TARAS S/D MANOCHAHAL		0916FL10	3 WIRE (UPS) NURPUR	NON AMR	OK	31.03.2023	Category 5-UPS				8223275	1200-600/5	7.208	NA	Director/D	
B.1554	Border	TARN TARAN	11KV	DS CITY DIVN. TARN TARAS S/D MANOCHAHAL		0916FL14	JEOBALA UPS	NON AMR	OK	31.03.2023	Category 5-UPS				8836635	1200-600/5	12.425	NA	Director/D	
B.1555	Border	TARN TARAN	11KV	DS CITY DIVN. TARN TARAS S/D MANOCHAHAL		0916FL13	MANOCHAL UPS	AMR	OK	31.03.2023	Category 5-UPS				7042910	900-450/5	16.790	NA	Director/D	
B.1556	Border	TARN TARAN	11KV	DS CITY DIVN. TARN TARAS S/D SARAI AMANT KHAN		0917FL18	KOT SWIAN	AMR	OK	31.03.2023	AP 3Phase 3Wire				3035	900-450/5	1.036	NA	Director/D	
B.1557	Border	TARN TARAN	11KV	DS CITY DIVN. TARN TARAS S/D SARAI AMANT KHAN		0917FL02	GEHARI	NON AMR	OK	31.03.2023	AP 3Phase 3Wire				11114515	1200-600/5	1.309	NA	Director/D	
B.1558	Border	TARN TARAN	11KV	DS CITY DIVN. TARN TARAS S/D SARAI AMANT KHAN		0917FL14	BABA WIRA DASS	NON AMR	OK	31.03.2023	AP 3Phase 3Wire				12093592	900-450/5	1.457	NA	Director/D	
B.1559	Border	TARN TARAN	11KV	DS CITY DIVN. TARN TARAS S/D SARAI AMANT KHAN		0917FL16	BABA JODI PEER	NON AMR	OK	31.03.2023	AP 3Phase 3Wire				11127166	900-450/5	1.575	NA	Director/D	
B.1560	Border	TARN TARAN	11KV	DS CITY DIVN. TARN TARAS S/D SARAI AMANT KHAN		0917FL05	BAGHARI	NON AMR	OK	31.03.2023	AP 3Phase 3Wire				9154297	1200-600/5	1.699	NA	Director/D	
B.1561	Border	TARN TARAN	11KV	DS CITY DIVN. TARN TARAS S/D SARAI AMANT KHAN		0917FL15	CHEEMA KHURD	NON AMR	OK	31.03.2023	AP 3Phase 3Wire				11117207	900-450/5	1.792	NA	Director/D	
B.1562	Border	TARN TARAN	11KV	DS CITY DIVN. TARN TARAS S/D SARAI AMANT KHAN		0917FL01	GANDWIND RURAL	AMR	OK	31.03.2023	AP 3Phase 3Wire				9534542	1200-600/5	1.804	NA	Director/D	
B.1563	Border	TARN TARAN	11KV	DS CITY DIVN. TARN TARAS S/D SARAI AMANT KHAN		0917FL04	NAUSHEHA DHALLA	AMR	OK	31.03.2023	AP 3Phase 3Wire				9154286	1200-600/5	1.853	NA	Director/D	
B.1564	Border	TARN TARAN	11KV	DS CITY DIVN. TARN TARAS S/D SARAI AMANT KHAN		0917FL20	JAMKA UPS	AMR	OK	31.03.2023	Category 5-UPS				3093	900-450/5	1.065	NA	Director/D	
B.1565	Border	TARN TARAN	11KV	DS CITY DIVN. TARN TARAS S/D SARAI AMANT KHAN		0917FL06	S.A.KHAN	AMR	OK	31.03.2023	AP 3Phase 3Wire				2066606	1200-600/5	2.076	NA	Director/D	
B.1566	Border	TARN TARAN	11KV	DS CITY DIVN. TARN TARAS S/D SARAI AMANT KHAN		0917FL17	BIBI SUKHAN	AMR	OK	31.03.2023	AP 3Phase 3Wire				3036	900-450/5	2.412	NA	Director/D	
B.1567	Border	TARN TARAN	11KV	DS CITY DIVN. TARN TARAS S/D SARAI AMANT KHAN		0917FL19	11 KV Dhakwala	AMR	OK	31.03.2023	AP 3Phase 3Wire				3196	900-450/5	2.726	NA	Director/D	
B.1568	Border	TARN TARAN	11KV	DS CITY DIVN. TARN TARAS S/D SARAI AMANT KHAN		0917FL12	KASEL	NON AMR	OK	31.03.2023	AP 3Phase 3Wire				2066861	900-450/5	2.768	NA	Director/D	
B.1569	Border	TARN TARAN	11KV	DS CITY DIVN. TARN TARAS S/D SARAI AMANT KHAN		0917FL07	DHAND	NON AMR	OK	31.03.2023	AP 3Phase 3Wire				2067020	900-450/5	2.872	NA	Director/D	
B.1570	Border	TARN TARAN	11KV	DS CITY DIVN. TARN TARAS S/D SARAI AMANT KHAN		0917FL08	CHEEMA BORDER	NON AMR	OK	31.03.2023	AP 3Phase 3Wire				2066557	900-450/5	3.063	NA	Director/D	
B.1571	Border	TARN TARAN	11KV	DS CITY DIVN. TARN TARAS S/D SARAI AMANT KHAN		0917FL11	GANDWIND 24 HRS SUPPLY	AMR	OK	31.03.2023	Category 5-UPS				9154350	1200-600/5	9.687	NA	Director/D	
B.1572	Border	TARN TARAN	11KV	DS CITY DIVN. TARN TARAS S/D SARAI AMANT KHAN		0917FL13	BABA JALAN JI	NON AMR	OK	31.03.2023	Category 5-UPS				11116912	1200-600/5	12.265	NA	Director/D	
B.1573	Border	TARN TARAN	11KV	DS CITY DIVN. TARN TARAS S/D SARAI AMANT KHAN		0917FL10	MANKPURA UPS	AMR	OK	31.03.2023	Category 5-UPS				2067815	900-450/5	14.745	NA	Director/D	
B.1574	Border	TARN TARAN	11KV	DS CITY DIVN. TARN TARAS S/D SUR SINGH		0946FL07	Benjam Pura	NON AMR	OK	31.03.2023	AP 3Phase 3Wire				5376	900-450/577/1-1-1	0.586	NA	Director/D	
B.1575	Border	TARN TARAN	11KV	DS CITY DIVN. TARN TARAS S/D SUR SINGH		0933F01	Baba Jagu Ji AP	AMR	OK	31.03.2023	AP 3Phase 3Wire				9534124	1200-600/5	3.920	NA	Director/D	
B.1576	Border	TARN TARAN	11KV	DS CITY DIVN. TARN TARAS S/D SUR SINGH		0933FL10	Baba Jagu Ji AP	AMR	OK	31.03.2023	AP 3Phase 3Wire				9534416	900-450/5	1.660	NA	Director/D	
B.1577	Border	TARN TARAN	11KV	DS CITY DIVN. TARN TARAS S/D SUR SINGH		0933FL09	BABA PUNJAB SINGH	AMR	OK	31.03.2023	AP 3Phase 3Wire				P8836709	1200-600/5	1.711	NA	Director/D	
B.1578	Border	TARN TARAN	11KV	DS CITY DIVN. TARN TARAS S/D SUR SINGH		0933FL11	Sain Bhagat AP	AMR	OK	31.03.2023	AP 3Phase 3Wire				3588	1200-600/5	1.807	NA	Director/D	
B.1579	Border	TARN TARAN	11KV	DS CITY DIVN. TARN TARAS S/D SUR SINGH		0933FL02	MALUWAL	AMR	OK	31.03.2023	AP 3Phase 3Wire				2067279	900-450/5	1.812	NA	Director/D	
B.1580	Border	TARN TARAN	11KV	DS CITY DIVN. TARN TARAS S/D SUR SINGH		0933FL03	SOHAL SINGH	AMR	OK	31.03.2023	AP 3Phase 3Wire				2066681	900-450/5	1.996	NA	Director/D	
B.1581	Border	TARN TARAN	11KV	DS CITY DIVN. TARN TARAS S/D SUR SINGH		0933FL12	Baba Khushi sah	NON AMR	OK	31.03.2023	Category 5-UPS				2066888	900-450/5	2.567	NA	Director/D	
B.1582	Border	TARN TARAN	11KV	DS CITY DIVN. TARN TARAS S/D SUR SINGH		0933FL08	SOHAL NO 2	NON AMR	OK	31.03.2023	AP 3Phase 3Wire				34234	1200-600/5	2.908	NA	Director/D	
B.1583	Border	TARN TARAN	11KV	DS CITY DIVN. TARN TARAS S/D SUR SINGH		0933FL05	GAGGBUA URBAN	NON AMR	OK	31.03.2023	Category 1				7346629	900-450/5	3.613	NA	Director/D	
B.1584	Border	TARN TARAN	11KV	DS CITY DIVN. TARN TARAS S/D SUR SINGH		0933FL04	24 Hrs. Sohal	AMR	OK	31.03.2023	Category 5-UPS				7346629	900-450/5	1.401	NA	Director/D	
B.1585	Border	TARN TARAN	11KV	DS CITY DIVN. TARN TARAS S/D SUR SINGH		0914FL05	BURI	AMR	OK	31.03.2023	AP 3Phase 3Wire				2047082	1200-600/5	17.727	NA	Director/D	
B.1586	Border	TARN TARAN	11KV	DS CITY DIVN. TARN TARAS S/D SUR SINGH		0922FL01	KALIA BIDI CHAND	AMR	OK	31.03.2023	AP 3Phase 3Wire				8223461	900-450/5	1.061			

S.No	Zone	Circle	Voltage Level (kVA)	Division (kVA)	Sub-Division (kVA)	Feeder ID	Feeder Name	Feeder Metering Status (Metred/unmetred/AM/AMR)	Status of Meter (Functional/Non-Functional)	Metering Date (Date of last actual meter reading/communication)	Feeder Type (Agr/Industrial/Mixed)	Status of Communication		Period from 01.04.2021 to 31.03.2022				Sales	Remarks (Source of data)
												% data received through automatically if feeder AMR/AM	Number of hours when meter was unable to communicate in period	Total Number of hours in the period	Meter S.No	CT/PT ratio	Import (kWh)		
B.1619	Border	TARN TARAN	11KV	DS DIVN. BHKIHWIND	DS S/D AMARKOT	0920FL07	Adia Amarkot	AMR	OK	31.03.2023	Category 1			43222	900-450/5	11,329	NA	Director/D	
B.1620	Border	TARN TARAN	11KV	DS DIVN. BHKIHWIND	DS S/D AMARKOT	0920FL14	UPS Valtoha	AMR	OK	31.03.2023	Category 5-UPS			8222772	1200-600/5	14,951	NA	Director/D	
B.1621	Border	TARN TARAN	11KV	DS DIVN. BHKIHWIND	DS S/D AMARKOT	0919FL03	Varnaha	AMR	OK	31.03.2023	AP 3Phase 3Wire			6761896	900-450/5	1,519	NA	Director/D	
B.1622	Border	TARN TARAN	11KV	DS DIVN. BHKIHWIND	DS S/D AMARKOT	0919FL17	VARNALA (B) AP	AMR	OK	31.03.2023	AP 3Phase 3Wire			56587	900-450/5	1,792	NA	Director/D	
B.1623	Border	TARN TARAN	11KV	DS DIVN. BHKIHWIND	DS S/D AMARKOT	0919FL16	RAMKHARA (B) AP	AMR	OK	31.03.2023	AP 3Phase 3Wire			5719	1200-600/5	2,506	NA	Director/D	
B.1624	Border	TARN TARAN	11KV	DS DIVN. BHKIHWIND	DS S/D AMARKOT	0919FL09	Ran Khara	AMR	OK	31.03.2023	AP 3Phase 3Wire			5295698	1200-600/5	2,846	NA	Director/D	
B.1625	Border	TARN TARAN	11KV	DS DIVN. BHKIHWIND	DS S/D AMARKOT	0919FL15	24 Hrs. UPS Ghatiala	AMR	OK	31.03.2023	Category 5-UPS			8223286	900-450/5	17,527	NA	Director/D	
B.1626	Border	TARN TARAN	11KV	DS DIVN. BHKIHWIND	DS S/D AMARKOT	0934FL07	THATHI	AMR	OK	31.03.2023	AP 3Phase 3Wire			4595	900-450/5	0,844	NA	Director/D	
B.1627	Border	TARN TARAN	11KV	DS DIVN. BHKIHWIND	DS S/D AMARKOT	0934FL03	Dholai Thathi	AMR	OK	31.03.2023	AP 3Phase 3Wire			9149910	900-450/5	0,966	NA	Director/D	
B.1628	Border	TARN TARAN	11KV	DS DIVN. BHKIHWIND	DS S/D AMARKOT	0934FL02	Palo Pati	AMR	OK	31.03.2023	AP 3Phase 3Wire			8223463	900-450/5	1,732	NA	Director/D	
B.1629	Border	TARN TARAN	11KV	DS DIVN. BHKIHWIND	DS S/D AMARKOT	0934FL01	11KV LAKHNA AP	AMR	OK	31.03.2023	AP 3Phase 3Wire			8222389	900-450/5	1,790	NA	Director/D	
B.1630	Border	TARN TARAN	11KV	DS DIVN. BHKIHWIND	DS S/D AMARKOT	0934FL05	RAJOKE	AMR	OK	31.03.2023	AP 3Phase 3Wire			P8824304	900-450/5	1,796	NA	Director/D	
B.1631	Border	TARN TARAN	11KV	DS DIVN. BHKIHWIND	DS S/D AMARKOT	0934FL04	24 Hrs. UPS Lakhna	NON AMR	OK	31.03.2023	Category 5-UPS			6669358	900-450/5	10,758	NA	Director/D	
B.1632	Border	TARN TARAN	11KV	DS DIVN. BHKIHWIND	DS S/D AMARKOT	0934FL06	UPS RAJOKE	AMR	OK	31.03.2023	Category 5-UPS			16199264	900-450/5	11,569	NA	Director/D	
B.1633	Border	TARN TARAN	11KV	DS DIVN. BHKIHWIND	DS S/D AMARKOT	0923FL05	BOP Wan	AMR	OK	31.03.2023	Category 4			P8832868	900-450/5/7/1-1-1	0,979	NA	Director/D	
B.1634	Border	TARN TARAN	11KV	DS DIVN. BHKIHWIND	DS S/D AMARKOT	0923FL04	Madda	AMR	OK	31.03.2023	AP 3Phase 3Wire			23711	900-450/5/7/1-1-1	1,976	NA	Director/D	
B.1635	Border	TARN TARAN	11KV	DS DIVN. BHKIHWIND	DS S/D AMARKOT	0923FL03	Rajoke	AMR	OK	31.03.2023	AP 3Phase 3Wire			23712	900-450/5	2,409	NA	Director/D	
B.1636	Border	TARN TARAN	11KV	DS DIVN. BHKIHWIND	DS S/D AMARKOT	0919FL11	11KV WARA TELIAN AP	AMR	OK	31.03.2023	AP 3Phase 3Wire			120992459	1200-600/5	1,510	NA	Director/D	
B.1637	Border	TARN TARAN	11KV	DS DIVN. BHKIHWIND	DS S/D AMARKOT	0919FL05	Wara Shera Singh	NON AMR	OK	31.03.2023	AP 3Phase 3Wire			11052033	1200-600/5	1,588	NA	Director/D	
B.1638	Border	TARN TARAN	11KV	DS DIVN. BHKIHWIND	DS S/D AMARKOT	0919FL12	BAHRIR Wali	AMR	OK	31.03.2023	AP 3Phase 3Wire			P8834333	1200-600/5	1,903	NA	Director/D	
B.1639	Border	TARN TARAN	11KV	DS DIVN. BHKIHWIND	DS S/D AMARKOT	0919FL04	Nawan Pind	AMR	OK	31.03.2023	AP 3Phase 3Wire			2056627	900-450/5	1,931	NA	Director/D	
B.1640	Border	TARN TARAN	11KV	DS DIVN. BHKIHWIND	DS S/D AMARKOT	0919FL09	Bhai Ladha Ji	AMR	OK	31.03.2023	AP 3Phase 3Wire			11052026	1200-600/5	2,485	NA	Director/D	
B.1641	Border	TARN TARAN	11KV	DS DIVN. BHKIHWIND	DS S/D AMARKOT	0919FL03	Ladhu	AMR	OK	31.03.2023	AP 3Phase 3Wire			2067003	900-450/5	2,633	NA	Director/D	
B.1642	Border	TARN TARAN	11KV	DS DIVN. BHKIHWIND	DS S/D AMARKOT	091908	24hr. UPS Ladhu	AMR	OK	31.03.2023	Category 5-UPS			11052057	1200-600/5	6,026	NA	Director/D	
B.1643	Border	TARN TARAN	11KV	DS DIVN. BHKIHWIND	DS S/D AMARKOT	0919FL01	Adiga Aligon	AMR	OK	31.03.2023	Category 1			961010217	900-450/5	6,250	NA	Director/D	
B.1644	Border	TARN TARAN	11KV	DS DIVN. BHKIHWIND	DS S/D AMARKOT	0919FL07	24 Hrs. UPS	AMR	OK	31.03.2023	Category 5-UPS			11052057	1200-600/5	11,811	NA	Director/D	
B.1645	Border	TARN TARAN	11KV	DS DIVN. BHKIHWIND	DS S/D AMARKOT	0938FL11	11KV DASHMESH NAGAR AP	AMR	OK	31.03.2023	AP 3Phase 3Wire			4598	900-450/5	1,505	NA	Director/D	
B.1646	Border	TARN TARAN	11KV	DS DIVN. BHKIHWIND	DS S/D AMARKOT	0938FL05	11KV BHABUDH NAGAR AP	AMR	OK	31.03.2023	AP 3Phase 3Wire			7336553	1200-600/5	1,577	NA	Director/D	
B.1647	Border	TARN TARAN	11KV	DS DIVN. BHKIHWIND	DS S/D BHKIHWIND	C031FL10	Makhi Kalan	AMR	OK	31.03.2023	AP 3Phase 3Wire			2066973	1200-600/5	0,523	NA	Director/D	
B.1648	Border	TARN TARAN	11KV	DS DIVN. BHKIHWIND	DS S/D BHKIHWIND	C031FL13	11 KV INDUSTRIAL FEEDER	AMR	OK	31.03.2023	Category 2			4562	900-450/5	1,156	NA	Director/D	
B.1649	Border	TARN TARAN	11KV	DS DIVN. BHKIHWIND	DS S/D BHKIHWIND	C031FL05	Sandhara	NON AMR	OK	31.03.2023	AP 3Phase 3Wire			101789	1200-600/5	1,983	NA	Director/D	
B.1650	Border	TARN TARAN	11KV	DS DIVN. BHKIHWIND	DS S/D BHKIHWIND	C031FL15	Marl Gour Singh	NON AMR	OK	31.03.2023	AP 3Phase 3Wire			232780	900-450/5	2,098	NA	Director/D	
B.1651	Border	TARN TARAN	11KV	DS DIVN. BHKIHWIND	DS S/D BHKIHWIND	C031FL08	Kalsian (132kv S/5 Bkhiwind)	AMR	OK	31.03.2023	AP 3Phase 3Wire			101856	900-450/5	2,116	NA	Director/D	
B.1652	Border	TARN TARAN	11KV	DS DIVN. BHKIHWIND	DS S/D BHKIHWIND	C031FL06	Draike	AMR	OK	31.03.2023	AP 3Phase 3Wire			8222671	900-450/5	2,246	NA	Director/D	
B.1653	Border	TARN TARAN	11KV	DS DIVN. BHKIHWIND	DS S/D BHKIHWIND	C031FL02	Dyal Pura	AMR	OK	31.03.2023	AP 3Phase 3Wire			8222675	1200-600/5	2,303	NA	Director/D	
B.1654	Border	TARN TARAN	11KV	DS DIVN. BHKIHWIND	DS S/D BHKIHWIND	C031FL03	Narla	AMR	OK	31.03.2023	AP 3Phase 3Wire			101190	1200-600/5	2,373	NA	Director/D	
B.1655	Border	TARN TARAN	11KV	DS DIVN. BHKIHWIND	DS S/D BHKIHWIND	C031FL16	BKHIHWIND	AMR	OK	31.03.2023	Category 1			3292	900-450/5	3,803	NA	Director/D	
B.1656	Border	TARN TARAN	11KV	DS DIVN. BHKIHWIND	DS S/D BHKIHWIND	C031FL07	Singh Pura	AMR	OK	31.03.2023	AP 3Phase 3Wire			100701	900-450/5	6,019	NA	Director/D	
B.1657	Border	TARN TARAN	11KV	DS DIVN. BHKIHWIND	DS S/D BHKIHWIND	C031FL01	B.S.F.	NON AMR	OK	31.03.2023	Category 1			101195	1200-600/5	4,541	NA	Director/D	
B.1658	Border	TARN TARAN	11KV	DS DIVN. BHKIHWIND	DS S/D BHKIHWIND	C031FL14	UPS Blair	NON AMR	OK	31.03.2023	Category 5-UPS			12527358	900-450/5	11,943	NA	Director/D	
B.1659	Border	TARN TARAN	11KV	DS DIVN. BHKIHWIND	DS S/D BHKIHWIND	C031FL09	24 Hrs. Ubran	NON AMR	OK	31.03.2023	Category 5-UPS			101790	900-450/5	15,228	NA	Director/D	
B.1660	Border	TARN TARAN	11KV	DS DIVN. BHKIHWIND	DS S/D BHKIHWIND	C031FL04	Adiga Bkhiwind	NON AMR	OK	31.03.2023	Category 1			2064424	1200-600/5	18,951	NA	Director/D	
B.1661	Border	TARN TARAN	11KV	DS DIVN. BHKIHWIND	DS S/D BHKIHWIND	0944FL04	Marl Gour Singh (66KV Kalsian)	NON AMR	OK	31.03.2023	AP 3Phase 3Wire			33658	200-100/5-5	1,259	NA	Director/D	
B.1662	Border	TARN TARAN	11KV	DS DIVN. BHKIHWIND	DS S/D BHKIHWIND	0944FL02	Bhagwarpura (66KV S/5 Kalsian)	AMR	OK	31.03.2023	AP 3Phase 3Wire			24271	200-100/5-5	2,124	NA	Director/D	
B.1663	Border	TARN TARAN	11KV	DS DIVN. BHKIHWIND	DS S/D BHKIHWIND	0944FL03	Makhi Kalan (66KV S/5 Kalsian)	NON AMR	OK	31.03.2023	AP 3Phase 3Wire			24329	200-100/5-5	2,206	NA	Director/D	
B.1664	Border	TARN TARAN	11KV	DS DIVN. BHKIHWIND	DS S/D BHKIHWIND	0944FL01	11KV KALSIAN UPS	AMR	OK	31.03.2023	Category 5-UPS			24331	200-100/5-5	5,080	NA	Director/D	
B.1665	Border	TARN TARAN	11KV	DS DIVN. BHKIHWIND	DS S/D BHKIHWIND	0944FL05	24 Hrs UPS Bhagwarpur	AMR	OK	31.03.2023	Category 5-UPS			3512	200-100/5-5	6,336	NA	Director/D	
B.1666	Border	TARN TARAN	11KV	DS DIVN. BHKIHWIND	DS S/D BHKIHWIND	0924FL23	DAHA MARIANA AP	AMR	OK	31.03.2023	AP 3Phase 3Wire			3241269	1200-600/5	1,026	NA	Director/D	
B.1667	Border	TARN TARAN	11KV	DS DIVN. BHKIHWIND	DS S/D BHKIHWIND	0924FL15	Soorwid	AMR	OK	31.03.2023	AP 3Phase 3Wire			9534426	1200-600/5	1,142	NA	Director/D	
B.1668	Border	TARN TARAN	11KV	DS DIVN. BHKIHWIND	DS S/D BHKIHWIND	0924FL24	DALPUR AP(KACHA PAKKA)	AMR	OK	31.03.2023	AP 3Phase 3Wire			73211255	900-450/5	1,421	NA	Director/D	
B.1669	Border	TARN TARAN	11KV	DS DIVN. BHKIHWIND	DS S/D BHKIHWIND	0924FL16	Akabapura	AMR	OK	31.03.2023	AP 3Phase 3Wire			9154492	1200-600/5	1,614	NA	Director/D	
B.1670	Border	TARN TARAN	11KV	DS DIVN. BHKIHWIND	DS S/D BHKIHWIND	0924FL07	Banka	AMR	OK	31.03.2023	AP 3Phase 3Wire			2066852	1200-600/5	2,011	NA	Director/D	
B.1671	Border	TARN TARAN	11KV	DS DIVN. BHKIHWIND	DS S/D BHKIHWIND	0924FL05	Gurwid	AMR	OK	31.03.2023	AP 3Phase 3Wire			6487718	900-450/5	2,042	NA	Director/D	
B.1672	Border	TARN TARAN	11KV	DS DIVN. BHKIHWIND	DS S/D BHKIHWIND	0924FL13	Nara	AMR	OK	31.03.2023	AP 3Phase 3Wire			9154076	1200-600/5	2,062	NA	Director/D	
B.1673	Border	TARN TARAN	11KV	DS DIVN. BHKIHWIND	DS S/D BHKIHWIND	0924FL03	Marhaur Pura	AMR	OK	31.03.2023	AP 3Phase 3Wire			4221151	900-450/5	2,152	NA	Director/D	
B.1674	Border	TARN TARAN	11KV	DS DIVN. BHKIHWIND	DS S/D BHKIHWIND	0924FL17	UPS Kacha-Packa	AMR	OK	31.03.2023	Category 5-UPS			11117034	1200-600/5	14,238	NA	Director/D	
B.1675	Border	TARN TARAN	11KV	DS DIVN. BHKIHWIND	DS S/D BHKIHWIND	0924FL05	Chung (MARI MEGHA)	NON AMR	OK	31.03.2023	AP 3Phase 3Wire			8222673	900-450/5	1,768	NA	Director/D	
B.1676	Border	TARN TARAN	11KV	DS DIVN. BHKIHWIND	DS S/D BHKIHWIND	0919FL16	New Blair	AMR	OK	31.03.2023	AP 3Phase 3Wire			15193864	1200-600/5	1,840	NA	Director/D	
B.1677	Border	TARN TARAN	11KV	DS DIVN. BHKIHWIND	DS S/D BHKIHWIND	0919FL07	Banka	AMR	OK	31.03.2023	AP 3Phase 3Wire			2067001	900-450/5	1,966	NA	Director/D	
B.1678	Border	TARN TARAN	11KV	DS DIVN. BHKIHWIND	DS S/D BHKIHWIND	0923FL08	New Wan	AMR	OK	31.03.2023	AP 3Phase 3Wire			PV002755	900-450/5/7/1-1-1	1,774	NA	Director/D	
B.1679	Border	TARN TARAN	11KV	DS DIVN. BHKIHWIND	DS S/D BHKIHWIND	0923FL09	Chak Bomba	AMR	OK	31.03.2023	AP 3Phase 3Wire			PV002768	900-450/5/7/1-1-1	1,889	NA	Director/D	
B.1680	Border	TARN TARAN	11KV	DS DIVN. BHKIHWIND	DS S/D BHKIHWIND	0923FL01	Wan	AMR	OK	31.03.2023	AP 3Phase 3Wire			23714	900-450/5	2,247	NA	Director/D	
B.1681	Border	TARN TARAN	11KV	DS DIVN. BHKIHWIND	DS S/D BHKIHWIND	0923FL02	Basrke	AMR	OK	31.03.2023	AP 3Phase 3Wire			23485	900-450/5	2,636	NA	Director/D	
B.1682	Border	TARN TARAN	11KV	DS DIVN. BHKIHWIND	DS S/D BHKIHWIND	0923FL09	UPS WAN TARA SINGH	AMR	OK	31.03.2023	Category 5-UPS			5321	900-450/5	4,597	NA	Director/D	
B.1683	Border	TARN TARAN	11KV	DS DIVN. BHKIHWIND	DS S/D BHKIHWIND	0923FL06	24 Hrs. UPS (wan Tara Singh)	AMR	OK	31.03.2023	Category 5-UPS			1618484	900-450/5/7/1-1-1	9,322	NA	Director/D	
B.1684	Border	TARN TARAN	11KV	DS DIVN. BHKIHWIND	DS S/D BHKIHWIND	8919FL02	Kalsian Kalan (220KV S/5 Aligon)	AMR	OK	31.03.2023	AP 3Phase 3Wire			206700					

S.No	Zone	Circle	Voltage Level (kVA)	Division (kVA)	Sub-Division (kVA)	Feeder Metering Status (Metered/unmetered/AMR/AMI)	Status of Meter (Functional/Non-Functional)	Metering Date (Date of last actual meter reading/communication)	Feeder Type (Agr/Industrial/Mixed)	Status of Communication		Period from 01.04.2021 to 31.03.2022				Sales	Remarks (Source of data)
										% data received through automatically by feeder AMR/AMI	Number of hours when meter was unable to communicate in overall	Total Number of hours in the period	Meter S.No	CT/PT ratio	Import (kWh)		
B.1716	Border	TARN TARAN	11KV	DS DIVN. BHKHIWIND	DS S/D KHEMKARAN	0948FL01	UPS BHURA KARIMPUR	AMR	OK	31.03.2023	Category 5-UPS		1745	900-450/5	10.211	NA	Director/D
B.1717	Border	TARN TARAN	11KV	DS DIVN. BHKHIWIND	DS S/D KHEMKARAN	0918FL14	NOORWALA (66 KV KheMKaran)	AMR	OK	31.03.2023	AP 3Phase 3Wire		670792	1200-600/5	1.168	NA	Director/D
B.1718	Border	TARN TARAN	11KV	DS DIVN. BHKHIWIND	DS S/D KHEMKARAN	0918FL19	MOHMIDDWALA HTHARH	AMR	OK	31.03.2023	AP 3Phase 3Wire		4658	900-450/5	1.615	NA	Director/D
B.1719	Border	TARN TARAN	11KV	DS DIVN. BHKHIWIND	DS S/D KHEMKARAN	0918FL13	Mahabandwala	AMR	OK	31.03.2023	AP 3Phase 3Wire		2066883	900-450/5	1.787	NA	Director/D
B.1720	Border	TARN TARAN	11KV	DS DIVN. BHKHIWIND	DS S/D KHEMKARAN	0918FL15	K K Barrier	AMR	OK	31.03.2023	AP 3Phase 3Wire		2066903	900-450/5	1.891	NA	Director/D
B.1721	Border	TARN TARAN	11KV	DS DIVN. BHKHIWIND	DS S/D KHEMKARAN	0918FL08	Mehdipur	AMR	OK	31.03.2023	AP 3Phase 3Wire		9141152	1200-600/5	1.967	NA	Director/D
B.1722	Border	TARN TARAN	11KV	DS DIVN. BHKHIWIND	DS S/D KHEMKARAN	0918FL04	11 KV BHURA KOHNA AP	AMR	OK	31.03.2023	AP 3Phase 3Wire		2066334	900-450/5	2.007	NA	Director/D
B.1723	Border	TARN TARAN	11KV	DS DIVN. BHKHIWIND	DS S/D KHEMKARAN	0918FL18	11 KV MEHDIPUR HTHARH AP	AMR	OK	31.03.2023	AP 3Phase 3Wire		4719	900-450/5	2.056	NA	Director/D
B.1724	Border	TARN TARAN	11KV	DS DIVN. BHKHIWIND	DS S/D KHEMKARAN	0918FL17	KK Barrier Main	AMR	OK	31.03.2023	AP 3Phase 3Wire		2066909	1200-600/5	2.068	NA	Director/D
B.1725	Border	TARN TARAN	11KV	DS DIVN. BHKHIWIND	DS S/D KHEMKARAN	0918FL01	Koti	AMR	OK	31.03.2023	AP 3Phase 3Wire		2066803	900-450/5	2.186	NA	Director/D
B.1726	Border	TARN TARAN	11KV	DS DIVN. BHKHIWIND	DS S/D KHEMKARAN	0918FL11	Mianwala	NON AMR	OK	31.03.2023	AP 3Phase 3Wire		2068051	900-450/5	2.394	NA	Director/D
B.1727	Border	TARN TARAN	11KV	DS DIVN. BHKHIWIND	DS S/D KHEMKARAN	918FL30	BHURA ASSAL	AMR	OK	31.03.2023	AP 3Phase 3Wire		4383	1200-600/5	2.500	NA	Director/D
B.1728	Border	TARN TARAN	11KV	DS DIVN. BHKHIWIND	DS S/D KHEMKARAN	0918FL10	BOP KK	AMR	OK	31.03.2023	Category 4		10288380	900-450/5	2.569	NA	Director/D
B.1729	Border	TARN TARAN	11KV	DS DIVN. BHKHIWIND	DS S/D KHEMKARAN	0918FL02	Khas	AMR	OK	31.03.2023	AP 3Phase 3Wire		16198495	900-450/5	2.903	NA	Director/D
B.1730	Border	TARN TARAN	11KV	DS DIVN. BHKHIWIND	DS S/D KHEMKARAN	0918FL03	Ratoka	AMR	OK	31.03.2023	AP 3Phase 3Wire		2066624	900-450/5	3.077	NA	Director/D
B.1731	Border	TARN TARAN	11KV	DS DIVN. BHKHIWIND	DS S/D KHEMKARAN	0918FL12	24 Hrs. UPS KheMKaran	AMR	OK	31.03.2023	Category 5-UPS		2066642	900-450/5	9.056	NA	Director/D
B.1732	Border	TARN TARAN	11KV	DS DIVN. BHKHIWIND	DS S/D KHEMKARAN	0918FL09	Khem Karan	AMR	OK	31.03.2023	Category 1		2068050	1200-600/5	9.347	NA	Director/D
B.1733	Border	TARN TARAN	11KV	DS DIVN. BHKHIWIND	DS S/D KHEMKARAN	0918FL16	UPS Machike	AMR	OK	31.03.2023	Category 5-UPS		9141154	1200-600/5	9.668	NA	Director/D
B.1734	Border	TARN TARAN	11KV	DS DIVN. BHKHIWIND	DS S/D KHEMKARAN	0925FL03	Joshi Singh Wala	AMR	OK	31.03.2023	AP 3Phase 3Wire		P8834106	1200/5771-1-1	1.333	NA	Director/D
B.1735	Border	TARN TARAN	11KV	DS DIVN. BHKHIWIND	DS S/D KHEMKARAN	0925FL13	Jhughan kulu	AMR	OK	31.03.2023	AP 3Phase 3Wire		2066684	1200/5771-1-1	1.333	NA	Director/D
B.1736	Border	TARN TARAN	11KV	DS DIVN. BHKHIWIND	DS S/D KHEMKARAN	0925FL15	UPS TALWANDI BUOH SINGH	AMR	OK	31.03.2023	Category 5-UPS		4682	900-450/5	7.671	NA	Director/D
B.1737	Border	TARN TARAN	11KV	DS DIVN. BHKHIWIND	DS S/D KHEMKARAN	0938FL01	11KV Kotli Waswa Singh AP	AMR	OK	31.03.2023	AP 3Phase 3Wire		7336683	1200-600/5	0.918	NA	Director/D
B.1738	Border	TARN TARAN	11KV	DS DIVN. BHKHIWIND	DS S/D KHEMKARAN	0938FL04	11 KV Gazzal AP	AMR	OK	31.03.2023	AP 3Phase 3Wire		7336515	1200-600/5	1.440	NA	Director/D
B.1739	Border	TARN TARAN	11KV	DS DIVN. BHKHIWIND	DS S/D KHEMKARAN	0938FL09	11 KV Ramuwal Kanda Tar AP	AMR	OK	31.03.2023	AP 3Phase 3Wire		36702	1200-600/5	1.499	NA	Director/D
B.1740	Border	TARN TARAN	11KV	DS DIVN. BHKHIWIND	DS S/D KHEMKARAN	0938FL07	JOH SINGH WALAKOTLI	AMR	OK	31.03.2023	AP 3Phase 3Wire		12093541	1200-600/5	1.605	NA	Director/D
B.1741	Border	TARN TARAN	11KV	DS DIVN. BHKHIWIND	DS S/D KHEMKARAN	0938FL12	11KV MAHNEKE AP	AMR	OK	31.03.2023	AP 3Phase 3Wire		4299	900-450/5	1.605	NA	Director/D
B.1742	Border	TARN TARAN	11KV	DS DIVN. BHKHIWIND	DS S/D KHEMKARAN	0938FL03	11 KV Ramuwal AP	AMR	OK	31.03.2023	AP 3Phase 3Wire		7336406	1200-600/5	1.643	NA	Director/D
B.1743	Border	TARN TARAN	11KV	DS DIVN. BHKHIWIND	DS S/D KHEMKARAN	0938FL13	11KV SARAI VALTOHA AP	AMR	OK	31.03.2023	AP 3Phase 3Wire		4579	1200-600/5	1.997	NA	Director/D
B.1744	Border	TARN TARAN	11KV	DS DIVN. BHKHIWIND	DS S/D KHEMKARAN	0938FL08	11KV Gazzal Kanda taar AP	AMR	OK	31.03.2023	AP 3Phase 3Wire		34192	1200-600/5	2.143	NA	Director/D
B.1745	Border	TARN TARAN	11KV	DS DIVN. BHKHIWIND	DS S/D KHEMKARAN	0938FL06	New UPS Kotli	AMR	OK	31.03.2023	Category 5-UPS		12093532	900-450/5	2.269	NA	Director/D
B.1746	Border	TARN TARAN	11KV	DS DIVN. BHKHIWIND	DS S/D KHEMKARAN	0938FL02	UPS Kotli	AMR	OK	31.03.2023	Category 5-UPS		7341795	1200-600/5	4.633	NA	Director/D
B.1747	Border	TARN TARAN	11KV	DS DIVN. BHKHIWIND	DS S/D KHEMKARAN	0938FL05	UPS RATIOTE	AMR	OK	31.03.2023	Category 5-UPS		P8834109	900-450/5	5.275	NA	Director/D
B.1748	Border	TARN TARAN	11KV	DS DIVN. PATTI	DS CITY S/D PATTI	8902FL12	URBAN HOSPITAL INDP	NON AMR	OK	31.03.2023	Category 4		70355628	1200-600/5	0.310	NA	Director/D
B.1749	Border	TARN TARAN	11KV	DS DIVN. PATTI	DS CITY S/D PATTI	8902FL01	KAIRON	AMR	OK	31.03.2023	AP 3Phase 3Wire		2066255	1200-600/5	1.742	NA	Director/D
B.1750	Border	TARN TARAN	11KV	DS DIVN. PATTI	DS CITY S/D PATTI	8902FL18	Urban Railway Station Patti	NON AMR	OK	31.03.2023	Category 1		583671	1200-600/5	5.715	NA	Director/D
B.1751	Border	TARN TARAN	11KV	DS DIVN. PATTI	DS CITY S/D PATTI	8902FL03	URBAN PATTI CITY	AMR	OK	31.03.2023	Category 1		2066313	1200-600/5	9.569	NA	Director/D
B.1752	Border	TARN TARAN	11KV	DS DIVN. PATTI	DS CITY S/D PATTI	8902FL10	URBAN CIVIL HOSPITAL PATTI	AMR	OK	31.03.2023	Category 1		2066464	1200-600/5	11.132	NA	Director/D
B.1753	Border	TARN TARAN	11KV	DS DIVN. PATTI	DS CITY S/D PATTI	8902FL10	URBAN GARDEN COLONY	AMR	OK	31.03.2023	Category 1		2067616	1200-600/5	12.776	NA	Director/D
B.1754	Border	TARN TARAN	11KV	DS DIVN. PATTI	DS CITY S/D PATTI	0921FL25	11 kv Muggalwala AP	AMR	OK	31.03.2023	AP 3Phase 3Wire		5596	900-450/5	1.795	NA	Director/D
B.1755	Border	TARN TARAN	11KV	DS DIVN. PATTI	DS CITY S/D PATTI	0921FL04	KULLAH	AMR	OK	31.03.2023	AP 3Phase 3Wire		8222388	900-450/5	1.804	NA	Director/D
B.1756	Border	TARN TARAN	11KV	DS DIVN. PATTI	DS CITY S/D PATTI	0921FL19	Manakpur	AMR	OK	31.03.2023	AP 3Phase 3Wire		9154488	1200-600/5	1.869	NA	Director/D
B.1757	Border	TARN TARAN	11KV	DS DIVN. PATTI	DS CITY S/D PATTI	0921FL08	MANIHALA R	AMR	OK	31.03.2023	AP 3Phase 3Wire		8223121	900-450/5	1.962	NA	Director/D
B.1758	Border	TARN TARAN	11KV	DS DIVN. PATTI	DS CITY S/D PATTI	0921FL06	SHRI EWAR	AMR	OK	31.03.2023	AP 3Phase 3Wire		4179229	900-450/5	1.239	NA	Director/D
B.1759	Border	TARN TARAN	11KV	DS DIVN. PATTI	DS CITY S/D PATTI	0921FL20	Bahmniwala	AMR	OK	31.03.2023	AP 3Phase 3Wire		2067119	900-450/5	3.645	NA	Director/D
B.1760	Border	TARN TARAN	11KV	DS DIVN. PATTI	DS CITY S/D PATTI	0921FL18	UPS PRAGPURA	AMR	OK	31.03.2023	Category 5-UPS		9154132	900-450/5	12.950	NA	Director/D
B.1761	Border	TARN TARAN	11KV	DS DIVN. PATTI	DS CITY S/D PATTI	0921FL21	UPS MANIHALA	NON AMR	OK	31.03.2023	Category 5-UPS		6607250	900-450/5	14.715	NA	Director/D
B.1762	Border	TARN TARAN	11KV	DS DIVN. PATTI	DS CITY S/D PATTI	0949FL05	Chuslewar AP	NON AMR	OK	31.03.2023	AP 3Phase 3Wire		12093492	1200-600/5	1.455	NA	Director/D
B.1763	Border	TARN TARAN	11KV	DS DIVN. PATTI	DS CITY S/D PATTI	0949FL10	PRAGPURA AP	NON AMR	OK	31.03.2023	AP 3Phase 3Wire		2066924	1200-600/5	1.266	NA	Director/D
B.1764	Border	TARN TARAN	11KV	DS DIVN. PATTI	DS CITY S/D PATTI	0943FL03	RAILWAY CROSSING PATTI AP	NON AMR	OK	31.03.2023	AP 3Phase 3Wire		23342	1200-600/5	2.500	NA	Director/D
B.1765	Border	TARN TARAN	11KV	DS DIVN. PATTI	DS CITY S/D PATTI	0943FL02	URBAN WADDI MANDI PATTI	NON AMR	OK	31.03.2023	Category 1		23218	1200-600/5	6.533	NA	Director/D
B.1766	Border	TARN TARAN	11KV	DS DIVN. PATTI	DS CITY S/D PATTI	0943FL01	URBAN CIRCULAR ROAD PATTI	NON AMR	OK	31.03.2023	Category 1		13190563	1200-600/5	10.471	NA	Director/D
B.1767	Border	TARN TARAN	11KV	DS DIVN. PATTI	DS CITY S/D PATTI	0943FL04	URBAN COURT ROAD PATTI	NON AMR	OK	31.03.2023	Category 1		12527318	1200-600/5	17.016	NA	Director/D
B.1768	Border	TARN TARAN	11KV	DS DIVN. PATTI	DS S/D HARIKE	0907FL08	URBAN MES & HEAD WORKS	NON AMR	OK	31.03.2023	Category 1		2066755	900-450/5	1.021	NA	Director/D
B.1769	Border	TARN TARAN	11KV	DS DIVN. PATTI	DS S/D HARIKE	0907FL14	KATTI HARIKE	AMR	OK	31.03.2023	AP 3Phase 3Wire		2066755	900-450/5	1.807	NA	Director/D
B.1770	Border	TARN TARAN	11KV	DS DIVN. PATTI	DS S/D HARIKE	0907FL15	GHRUAM R	AMR	OK	31.03.2023	AP 3Phase 3Wire		2066755	900-450/5	1.870	NA	Director/D
B.1771	Border	TARN TARAN	11KV	DS DIVN. PATTI	DS S/D HARIKE	0907FL06	KIRTOVAL R	AMR	OK	31.03.2023	AP 3Phase 3Wire		8223288	900-450/5	2.237	NA	Director/D
B.1772	Border	TARN TARAN	11KV	DS DIVN. PATTI	DS S/D HARIKE	0907FL11	RATTA GUDDA NEW	NON AMR	OK	31.03.2023	AP 3Phase 3Wire		1577	900-450/5	2.301	NA	Director/D
B.1773	Border	TARN TARAN	11KV	DS DIVN. PATTI	DS S/D HARIKE	0907FL05	MARHANA	AMR	OK	31.03.2023	AP 3Phase 3Wire		23668	900-450/5	2.342	NA	Director/D
B.1774	Border	TARN TARAN	11KV	DS DIVN. PATTI	DS S/D HARIKE	0907FL10	SHANKH HARIKE	AMR	OK	31.03.2023	AP 3Phase 3Wire		2066948	900-450/5	2.461	NA	Director/D
B.1775	Border	TARN TARAN	11KV	DS DIVN. PATTI	DS S/D HARIKE	0907FL02	BOOH HAWALIAN	NON AMR	OK	31.03.2023	AP 3Phase 3Wire		2595702	900-450/5	2.507	NA	Director/D
B.1776	Border	TARN TARAN	11KV	DS DIVN. PATTI	DS S/D HARIKE	0907FL04	KUTIWALA	AMR	OK	31.03.2023	AP 3Phase 3Wire		23639	900-450/5	2.545	NA	Director/D
B.1777	Border	TARN TARAN	11KV	DS DIVN. PATTI	DS S/D HARIKE	0907FL03	RATTA GUDDA	AMR	OK	31.03.2023	AP 3Phase 3Wire		9534495	900-450/5	2.942	NA	Director/D
B.1778	Border	TARN TARAN	11KV	DS DIVN. PATTI	DS S/D HARIKE	0907FL12	TUNG NEW	NON AMR	OK	31.03.2023	AP 3Phase 3Wire		9534425	900-450/5	2.948	NA	Director/D
B.1779	Border	TARN TARAN	11KV	DS DIVN. PATTI	DS S/D HARIKE	0907FL13	UPS JEONKE	AMR	OK	31.03.2023	Category 5-UPS		7336393	900-450/5	6.351	NA	Director/D
B.1780	Border	TARN TARAN	11KV	DS DIVN. PATTI	DS S/D HARIKE	0907FL01	UPS KIRTOVAL	AMR	OK	31.03.2023	Category 5-UPS		2066218	900-450/5	11.103	NA	Director/D
B.1781	Border	TARN TARAN	11KV	DS DIVN. PATTI	DS S/D HARIKE	0907FL07	URBAN ADDA HARIKE	NON AMR	OK	31.03.2023	Category 1		8223287	900-450/5	12.156	NA	Director/D
B.1782	Border	TARN TARAN	11KV	DS DIVN. PATTI	DS S/D HARIKE	0936FL07	Nabipur AP	NON AMR	OK	31.03.2023	AP 3Phase 3Wire		23802	900-450/5	1.636	NA	Director/D
B.1783	Border	TARN TARAN	11KV	DS DIVN. PATTI	DS S/D HARIKE	0936FL05	Koti Datta	AMR	OK	31.03.2023	AP 3Phase 3Wire		9154115	900-450/5	1.806	NA	Director/D
B.1784	Border	TARN TAR															

S.No	Zone	Circle	Voltage Level (kVA)	Division (kVA)	Sub-Division (kVA)	Feeder ID	Feeder Name	Feeder Metering Status (Metered/unmetered/AMR/AM)	Status of Meter (Functional/Non-Functional)	Metering Date (Date of last actual meter reading/communication)	Feeder Type (Agr/Industrial/Mixed)	Status of Communication			Period from 01.04.2021 to 31.03.2022				Sales	Remarks (Source of data)
												% data received through automatically if feeder AMR/AM	Number of hours when meter was unable to communicate in overall	Total Number of hours in the period	Meter S.No	CT/PT ratio	Import (kWh)	Export (kWh)		
B.1813	Border	TARN TARAN	11KV	DS DIVN. PATTI	DS S/D SARHALI	0909FL07	MAND AP	AMR	OK	31.03.2023	AP 3Phase 3Wire				11116712	900-450/5	2,513	NA	Director/D	
B.1814	Border	TARN TARAN	11KV	DS DIVN. PATTI	DS S/D SARHALI	0909FL03	URBAN BRAHMAMPURA	NON AMR	OK	31.03.2023	Category 1				4221036	900-450/5	5,507	NA	Director/D	
B.1815	Border	TARN TARAN	11KV	DS DIVN. PATTI	DS S/D SARHALI	0909FL06	UPS DERA SAHIB	NON AMR	OK	31.03.2023	Category 5-U/PS				4188542	900-450/5	8,645	NA	Director/D	
B.1816	Border	TARN TARAN	11KV	DS DIVN. PATTI	DS S/D SARHALI	0909FL12	Germiana wala	NON AMR	OK	31.03.2023	AP 3Phase 3Wire				11117101	900-450/5	1,172	NA	Director/D	
B.1817	Border	TARN TARAN	11KV	DS DIVN. PATTI	DS S/D SARHALI	0908FL16	GANDWIND R	NON AMR	OK	31.03.2023	AP 3Phase 3Wire				23	900-450/5	1,285	NA	Director/D	
B.1818	Border	TARN TARAN	11KV	DS DIVN. PATTI	DS S/D SARHALI	0908FL15	SOHAWA AP	NON AMR	OK	31.03.2023	AP 3Phase 3Wire				116859	900-450/5	1,672	NA	Director/D	
B.1819	Border	TARN TARAN	11KV	DS DIVN. PATTI	DS S/D SARHALI	0908FL08	PAKHUPUR	NON AMR	OK	31.03.2023	AP 3Phase 3Wire				11117021	900-450/5	1,783	NA	Director/D	
B.1820	Border	TARN TARAN	11KV	DS DIVN. PATTI	DS S/D SARHALI	0908FL01	BATOKE AP	NON AMR	OK	31.03.2023	AP 3Phase 3Wire				72	900-450/5	1,793	NA	Director/D	
B.1821	Border	TARN TARAN	11KV	DS DIVN. PATTI	DS S/D SARHALI	0908FL17	Chambha	NON AMR	OK	31.03.2023	AP 3Phase 3Wire				11116804	900-450/5	1,835	NA	Director/D	
B.1822	Border	TARN TARAN	11KV	DS DIVN. PATTI	DS S/D SARHALI	0908FL13	Chambha	NON AMR	OK	31.03.2023	AP 3Phase 3Wire				11116757	900-450/5	1,962	NA	Director/D	
B.1823	Border	TARN TARAN	11KV	DS DIVN. PATTI	DS S/D SARHALI	0908FL03	RURIWALA	NON AMR	OK	31.03.2023	AP 3Phase 3Wire				11116970	900-450/5	2,109	NA	Director/D	
B.1824	Border	TARN TARAN	11KV	DS DIVN. PATTI	DS S/D SARHALI	0908FL02	KARMUWALA	NON AMR	OK	31.03.2023	AP 3Phase 3Wire				11117122	900-450/5	2,151	NA	Director/D	
B.1825	Border	TARN TARAN	11KV	DS DIVN. PATTI	DS S/D SARHALI	0908FL05	SANGAPURA	NON AMR	OK	31.03.2023	AP 3Phase 3Wire				11114555	900-450/5	2,267	NA	Director/D	
B.1826	Border	TARN TARAN	11KV	DS DIVN. PATTI	DS S/D SARHALI	0908FL11	RANJANWAL	NON AMR	OK	31.03.2023	AP 3Phase 3Wire				11116842	900-450/5	2,383	NA	Director/D	
B.1827	Border	TARN TARAN	11KV	DS DIVN. PATTI	DS S/D SARHALI	0908FL06	GUJARPURA	NON AMR	OK	31.03.2023	AP 3Phase 3Wire				11116839	900-450/5	2,540	NA	Director/D	
B.1828	Border	TARN TARAN	11KV	DS DIVN. PATTI	DS S/D SARHALI	0908FL07	DHUN	NON AMR	OK	31.03.2023	AP 3Phase 3Wire				11116968	900-450/5	2,930	NA	Director/D	
B.1829	Border	TARN TARAN	11KV	DS DIVN. PATTI	DS S/D SARHALI	0908FL10	UPS BABA BHAI KALU JI	AMR	OK	31.03.2023	Category 5-U/PS				11117082	900-450/5	10,206	NA	Director/D	
B.1830	Border	TARN TARAN	11KV	DS DIVN. PATTI	DS S/D SARHALI	0908FL19	UPS BHAI ADALU JI	NON AMR	OK	31.03.2023	Category 5-U/PS				1112554	900-450/5	10,776	NA	Director/D	
B.1831	Border	TARN TARAN	11KV	DS DIVN. PATTI	DS S/D SARHALI	0908FL09	URBAN CHOHLA	NON AMR	OK	31.03.2023	Category 1				5437510	900-450/5	10,906	NA	Director/D	
B.1832	Border	TARN TARAN	11KV	DS DIVN. PATTI	DS S/D SARHALI	0911FL05	DALALKE AP	AMR	OK	31.03.2023	AP 3Phase 3Wire				13194943	1200-600/5	2,208	NA	Director/D	
B.1833	Border	TARN TARAN	11KV	DS DIVN. PATTI	DS S/D SARHALI	0911FL09	BABA KANIO PEER	AMR	OK	31.03.2023	AP 3Phase 3Wire				36793	900-450/5	2,105	NA	Director/D	
B.1834	Border	TARN TARAN	11KV	DS DIVN. PATTI	DS S/D SARHALI	0912FL10	Dhatala	AMR	OK	31.03.2023	AP 3Phase 3Wire				2066710	900-450/5	2,379	NA	Director/D	
B.1835	Border	TARN TARAN	11KV	DS DIVN. PATTI	DS S/D SARHALI	0912FL03	SUHAWA	AMR	OK	31.03.2023	AP 3Phase 3Wire				9334403	900-450/5	2,478	NA	Director/D	
B.1836	Border	TARN TARAN	11KV	DS DIVN. PATTI	DS S/D SARHALI	0912FL05	DADEHAR SAHIB	AMR	OK	31.03.2023	AP 3Phase 3Wire				2066773	1200-600/5	2,672	NA	Director/D	
B.1837	Border	TARN TARAN	11KV	DS DIVN. PATTI	DS S/D SARHALI	0912FL11	SHAKI	AMR	OK	31.03.2023	AP 3Phase 3Wire				6761892	900-450/5	2,696	NA	Director/D	
B.1838	Border	TARN TARAN	11KV	DS DIVN. PATTI	DS S/D SARHALI	0912FL02	THATHA	AMR	OK	31.03.2023	AP 3Phase 3Wire				6480742	900-450/5	2,876	NA	Director/D	
B.1839	Border	TARN TARAN	11KV	DS DIVN. PATTI	DS S/D SARHALI	0912FL06	BURJI	AMR	OK	31.03.2023	AP 3Phase 3Wire				2067631	900-450/5	2,935	NA	Director/D	
B.1840	Border	TARN TARAN	11KV	DS DIVN. PATTI	DS S/D SARHALI	0912FL04	KHARA	AMR	OK	31.03.2023	AP 3Phase 3Wire				2067286	900-450/5	3,699	NA	Director/D	
B.1841	Border	TARN TARAN	11KV	DS DIVN. PATTI	DS S/D SARHALI	0912FL12	UPS SHAKRI	NON AMR	OK	31.03.2023	Category 5-U/PS				564580	1200-600/5	8,817	NA	Director/D	
B.1842	Border	TARN TARAN	11KV	DS DIVN. PATTI	DS S/D SARHALI	0913FL01	URBAN SARHALI	NON AMR	OK	31.03.2023	Category 1				9534370	900-450/5	9,110	NA	Director/D	
B.1843	Border	TARN TARAN	11KV	DS DIVN. PATTI	DS S/D SARHALI	0913FL07	UPS KHARA	AMR	OK	31.03.2023	Category 5-U/PS				6007262	900-450/5	11,414	NA	Director/D	
B.1844	Border	TARN TARAN	11KV	DS DIVN. PATTI	DS S/D SARHALI	8902FL17	HAWELIAN BHAGUPUR	NON AMR	OK	31.03.2023	AP 3Phase 3Wire				1224956	1200-600/5	0,854	NA	Director/D	
B.1845	Border	TARN TARAN	11KV	DS DIVN. PATTI	DS S/U S/D PATTI	8902FL14	Bhagpur	AMR	OK	31.03.2023	AP 3Phase 3Wire				5295567	1200-600/5	1,297	NA	Director/D	
B.1846	Border	TARN TARAN	11KV	DS DIVN. PATTI	DS S/U S/D PATTI	8902FL08	BARWALA	NON AMR	OK	31.03.2023	AP 3Phase 3Wire				6740808	1200-600/5	1,846	NA	Director/D	
B.1847	Border	TARN TARAN	11KV	DS DIVN. PATTI	DS S/U S/D PATTI	8902FL04	TUNG	NON AMR	OK	31.03.2023	AP 3Phase 3Wire				7336635	1200-600/5	1,958	NA	Director/D	
B.1848	Border	TARN TARAN	11KV	DS DIVN. PATTI	DS S/U S/D PATTI	8902FL15	SANGWAN AP	AMR	OK	31.03.2023	AP 3Phase 3Wire				23669	1200-600/5	2,204	NA	Director/D	
B.1849	Border	TARN TARAN	11KV	DS DIVN. PATTI	DS S/U S/D PATTI	8902FL06	PRINGR R NADODHAR	NON AMR	OK	31.03.2023	AP 3Phase 3Wire				7336264	1200-600/5	2,247	NA	Director/D	
B.1850	Border	TARN TARAN	11KV	DS DIVN. PATTI	DS S/U S/D PATTI	8902FL11	BHAGHUPUR	AMR	OK	31.03.2023	AP 3Phase 3Wire				2066939	1200-600/5	2,440	NA	Director/D	
B.1851	Border	TARN TARAN	11KV	DS DIVN. PATTI	DS S/U S/D PATTI	8902FL05	UPS CHEEMA	NON AMR	OK	31.03.2023	Category 5-U/PS				5463608	1200-600/5	8,792	NA	Director/D	
B.1852	Border	TARN TARAN	11KV	DS DIVN. PATTI	DS S/U S/D PATTI	0937FL06	DUBLI NEW	AMR	OK	31.03.2023	AP 3Phase 3Wire				37596	900-450/5	1,171	NA	Director/D	
B.1853	Border	TARN TARAN	11KV	DS DIVN. PATTI	DS S/U S/D PATTI	0937FL07	DUBLI GHARYALA ROAD	NON AMR	OK	31.03.2023	AP 3Phase 3Wire				99154151	900-450/5	1,690	NA	Director/D	
B.1854	Border	TARN TARAN	11KV	DS DIVN. PATTI	DS S/U S/D PATTI	0937FL03	JOUR SINGH WALA NEW	NON AMR	OK	31.03.2023	AP 3Phase 3Wire				37286	900-450/5	2,001	NA	Director/D	
B.1855	Border	TARN TARAN	11KV	DS DIVN. PATTI	DS S/U S/D PATTI	0937FL04	ROTI NAU ABAD	AMR	OK	31.03.2023	AP 3Phase 3Wire				37387	900-450/5	2,141	NA	Director/D	
B.1856	Border	TARN TARAN	11KV	DS DIVN. PATTI	DS S/U S/D PATTI	0937FL05	SHAHEED NEW	AMR	OK	31.03.2023	AP 3Phase 3Wire				37099	900-450/5	2,517	NA	Director/D	
B.1857	Border	TARN TARAN	11KV	DS DIVN. PATTI	DS S/U S/D PATTI	0937FL02	DUBLI R	NON AMR	OK	31.03.2023	AP 3Phase 3Wire				20341	900-450/5	3,267	NA	Director/D	
B.1858	Border	TARN TARAN	11KV	DS DIVN. PATTI	DS S/U S/D PATTI	0937FL08	UPS SHAHEED BABA DEEP SINGH	AMR	OK	31.03.2023	Category 5-U/PS				37132	900-450/5	4,838	NA	Director/D	
B.1859	Border	TARN TARAN	11KV	DS DIVN. PATTI	DS S/U S/D PATTI	0937FL01	URBAN DUBLI	AMR	OK	31.03.2023	Category 1				9154333	900-450/5	6,303	NA	Director/D	
B.1860	Border	TARN TARAN	11KV	DS DIVN. PATTI	DS S/U S/D PATTI	0910FL13	Thatha Dhariwal	AMR	OK	31.03.2023	AP 3Phase 3Wire				3574	900-450/5	1,428	NA	Director/D	
B.1861	Border	TARN TARAN	11KV	DS DIVN. PATTI	DS S/U S/D PATTI	0910FL06	THATHA	AMR	OK	31.03.2023	AP 3Phase 3Wire				9154144	1200-600/5	2,330	NA	Director/D	
B.1862	Border	TARN TARAN	11KV	DS DIVN. PATTI	DS S/U S/D PATTI	0910FL12	Jand Branch	AMR	OK	31.03.2023	AP 3Phase 3Wire				15194855	1200-600/5	2,859	NA	Director/D	
B.1863	Border	TARN TARAN	11KV	DS DIVN. PATTI	DS S/U S/D PATTI	0910FL02	JAND	AMR	OK	31.03.2023	AP 3Phase 3Wire				6679846	1200-600/5	2,963	NA	Director/D	
B.1864	Border	TARN TARAN	11KV	DS DIVN. PATTI	DS S/U S/D PATTI	0910FL04	CHAN CHAK	AMR	OK	31.03.2023	AP 3Phase 3Wire				11117255	1200-600/5	3,711	NA	Director/D	
B.1865	Border	TARN TARAN	11KV	DS DIVN. PATTI	DS S/U S/D PATTI	0910FL07	GHARYALI KAREWALI	AMR	OK	31.03.2023	AP 3Phase 3Wire				9154256	1200-600/5	4,400	NA	Director/D	
B.1866	Border	TARN TARAN	11KV	DS DIVN. PATTI	DS S/U S/D PATTI	0910FL16	UPS SHAHEED NATHA SINGH	NON AMR	OK	31.03.2023	Category 5-U/PS				1310	900-450/5	4,928	NA	Director/D	
B.1867	Border	TARN TARAN	11KV	DS DIVN. PATTI	DS S/U S/D PATTI	0910FL08	GHARYALA R	AMR	OK	31.03.2023	AP 3Phase 3Wire				11069755	900-450/5	5,248	NA	Director/D	
B.1868	Border	TARN TARAN	11KV	DS DIVN. PATTI	DS S/U S/D PATTI	0910FL05	URBAN GHARYALA	NON AMR	OK	31.03.2023	Category 1				8222995	900-450/5	14,785	NA	Director/D	
B.1869	Border	TARN TARAN	11KV	DS DIVN. PATTI	DS S/U S/D PATTI	0938FL02	PRINGR R	NON AMR	OK	31.03.2023	AP 3Phase 3Wire				9154135	900-450/5	1,069	NA	Director/D	
B.1870	Border	TARN TARAN	11KV	DS DIVN. PATTI	DS S/U S/D PATTI	0938FL01	PANGOTA	NON AMR	OK	31.03.2023	AP 3Phase 3Wire				9153611	900-450/5	1,990	NA	Director/D	
B.1871	Border	TARN TARAN	11KV	DS DIVN. PATTI	DS S/U S/D PATTI	0938FL03	SANPUR	NON AMR	OK	31.03.2023	AP 3Phase 3Wire				9153606	900-450/5	2,247	NA	Director/D	
B.1872	Border	TARN TARAN	11KV	DS DIVN. PATTI	DS S/U S/D PATTI	0938FL02	URBAN PRINGRI	NON AMR	OK	31.03.2023	Category 5-U/PS				9153622	900-450/5	2,818	NA	Director/D	
B.1873	Border	TARN TARAN	11KV	DS DIVN. PATTI	DS S/U S/D PATTI	0938FL06	UPS PRINGRI	AMR	OK	31.03.2023	Category 5-U/PS				9154538	900-450/5	6,626	NA	Director/D	
B.1874	Border	TARN TARAN	11KV	DS DIVN. PATTI	DS S/U S/D PATTI	FL08D936	UPS PANGOTA	NON AMR	OK	31.03.2023	Category 5-U/PS				197928	900-450/5	8,150	NA	Director/D	
B.1875	Border	TARN TARAN	11KV	DS DIVN. PATTI	DS S/U S/D PATTI	0911FL06	SADDO	AMR	OK	31.03.2023	AP 3Phase 3Wire				822357	900-450/5	1,886	NA	Director/D	
B.1876	Border	TARN TARAN	11KV	DS DIVN. PATTI	DS S/U S/D PATTI	0911FL10	GHULLEWAL	AMR	OK	31.03.2023	AP 3Phase 3Wire				9153404	900-450/5	2,041	NA	Director/D	
B.1877	Border	TARN TARAN	11KV	DS DIVN. PATTI	DS S/U S/D PATTI	0911FL08	KUTIWALA NEW	AMR	OK	31.03.2023	AP 3Phase 3Wire				9534257	900-450/5	2,126	NA	Director/D	
B.1878	Border	TARN TARAN	11KV	DS DIVN. PATTI	DS S/U S/D PATTI	0911FL01														

S.No	Zone	Circle	Voltage Level (kVA)	Division (kVA)	Sub-Division (kVA)	Feeder ID	Feeder Name	Feeder Metering Status (Metered/unmetered/AMR/AMI)	Status of Meter (Functional/Non-functional)	Metering Date	Date of last actual meter reading/communication	Feeder Type (Agr/Industrial/Mixed)	Status of Communication			Period from 01.04.2021 to 31.03.2022				Sales	Remarks (Source of data)
													% data received through automatically if feeder AMR/AMI	Number of hours when meter was unable to communicate in overall	Total Number of hours in the period	Meter S.No	CT/PT ratio	Import (kWh)	Export (kWh)		
B.1910	Border	TARN TARAN	11KV	DS DIVN. RAYYA AT BEAS/D/ BABA BAKALA		0928F02	KHANPUR	NON AMR	OK	31.03.2023		AP 3Phase 3Wire				9154391	900-450/5	2,797	NA	Director/D	
B.1911	Border	TARN TARAN	11KV	DS DIVN. RAYYA AT BEAS/D/ BABA BAKALA		0928F04	THATHIAN UPS	NON AMR	OK	31.03.2023		AP 3Phase 5UPS				34188	900-450/5	3,448	NA	Director/D	
B.1912	Border	TARN TARAN	11KV	DS DIVN. RAYYA AT BEAS/D/ BABA BAKALA		0928F01	SEON	NON AMR	OK	31.03.2023		AP 3Phase 3Wire				900-450/5	3,472	NA	Director/D		
B.1913	Border	TARN TARAN	11KV	DS DIVN. RAYYA AT BEAS/D/ BABA BAKALA		0928F06	GARGABHANA	AMR	OK	31.03.2023		AP 3Phase 5UPS				8222899	900-450/5	3,810	NA	Director/D	
B.1914	Border	TARN TARAN	11KV	DS DIVN. RAYYA AT BEAS/D/ BABA BAKALA		0928F11	BUTALA URBAN	NON AMR	OK	31.03.2023		Category 5-UPS				2066726	900-450/5	5,098	NA	Director/D	
B.1915	Border	TARN TARAN	11KV	DS DIVN. RAYYA AT BEAS/D/ BABA BAKALA		0928F10	SATHIALA URBAN	AMR	OK	31.03.2023		Category 1				689	900-450/5	6,484	NA	Director/D	
B.1916	Border	TARN TARAN	11KV	DS DIVN. RAYYA AT BEAS/D/ BABA BAKALA		0939F05	Satowal	NON AMR	OK	31.03.2023		AP 3Phase 3Wire				4455	900-450/5	1,865	NA	Director/D	
B.1917	Border	TARN TARAN	11KV	DS DIVN. RAYYA AT BEAS/D/ BABA BAKALA		0939F06	SHAPUR	NON AMR	OK	31.03.2023		AP 3Phase 3Wire				12093464	900-450/5	1,955	NA	Director/D	
B.1918	Border	TARN TARAN	11KV	DS DIVN. RAYYA AT BEAS/D/ BABA BAKALA		0939F07	RAJADWAL	NON AMR	OK	31.03.2023		AP 3Phase 3Wire				12093476	900-450/5	2,944	NA	Director/D	
B.1919	Border	TARN TARAN	11KV	DS DIVN. RAYYA AT BEAS/D/ BABA BAKALA		0939F01	KARTARPUR RURAL	NON AMR	OK	31.03.2023		AP 3Phase 3Wire				12093482	900-450/5	2,291	NA	Director/D	
B.1920	Border	TARN TARAN	11KV	DS DIVN. RAYYA AT BEAS/D/ BABA BAKALA		0939F03	BUTALA UPS	NON AMR	OK	31.03.2023		Category 5-UPS				12093488	900-450/5	5,693	NA	Director/D	
B.1921	Border	TARN TARAN	11KV	DS DIVN. RAYYA AT BEAS/D/ BABA BAKALA		0939F04	KARTARPUR UPS	AMR	OK	31.03.2023		Category 5-UPS				1209487	900-450/5	8,674	NA	Director/D	
B.1922	Border	TARN TARAN	11KV	DS DIVN. RAYYA AT BEAS/D/ BEAS		0939F08	DERA BACK FEEDING	NON AMR	OK	31.03.2023		Category 1				9534520	1200-600/5	0,261	NA	Director/D	
B.1923	Border	TARN TARAN	11KV	DS DIVN. RAYYA AT BEAS/D/ BEAS		0939F05	RAILWAY STATION	NON AMR	OK	31.03.2023		Category 2				9534520	1200-600/5	0,457	NA	Director/D	
B.1924	Border	TARN TARAN	11KV	DS DIVN. RAYYA AT BEAS/D/ BEAS		0939F06	Budha Theh	NON AMR	OK	31.03.2023		Category 5-UPS				2066104	1200-600/5	2,427	NA	Director/D	
B.1925	Border	TARN TARAN	11KV	DS DIVN. RAYYA AT BEAS/D/ BEAS		0939F04	Rural Beas	AMR	OK	31.03.2023		AP 3Phase 3Wire				82223507	1200-600/5	2,441	NA	Director/D	
B.1926	Border	TARN TARAN	11KV	DS DIVN. RAYYA AT BEAS/D/ BEAS		0939F03	DERA BEAS	NON AMR	OK	31.03.2023		Category 2				5141	1200-600/5	2,889	NA	Director/D	
B.1927	Border	TARN TARAN	11KV	DS DIVN. RAYYA AT BEAS/D/ BEAS		0939F01	DERA BABA JAINAL SINGH	NON AMR	OK	31.03.2023		Category 2				5153	1200-600/5	3,688	NA	Director/D	
B.1928	Border	TARN TARAN	11KV	DS DIVN. RAYYA AT BEAS/D/ BEAS		0939F07	MESI-II	AMR	OK	31.03.2023		Category 2				7062862	1200-600/5	4,046	NA	Director/D	
B.1929	Border	TARN TARAN	11KV	DS DIVN. RAYYA AT BEAS/D/ BEAS		0939F02	SATSIANG PANDAL	NON AMR	OK	31.03.2023		Category 2				5172	1200-600/5	5,315	NA	Director/D	
B.1930	Border	TARN TARAN	11KV	DS DIVN. RAYYA AT BEAS/D/ BEAS		0928F11	JALLUWAL	NON AMR	OK	31.03.2023		AP 3Phase 3Wire				23751	400-200/5	0,384	NA	Director/D	
B.1931	Border	TARN TARAN	11KV	DS DIVN. RAYYA AT BEAS/D/ BEAS		0928F14	WAJIR BHULLAR	NON AMR	OK	31.03.2023		AP 3Phase 3Wire				4219659	1200-600/5	1,540	NA	Director/D	
B.1932	Border	TARN TARAN	11KV	DS DIVN. RAYYA AT BEAS/D/ BEAS		0928F07	MSSC HOSPITAL	NON AMR	OK	31.03.2023		Category 2				11069754	1200-600/5	1,695	NA	Director/D	
B.1933	Border	TARN TARAN	11KV	DS DIVN. RAYYA AT BEAS/D/ BEAS		0928F08	UMRANAGAL	NON AMR	OK	31.03.2023		AP 3Phase 3Wire				11069769	1200-600/5	2,291	NA	Director/D	
B.1934	Border	TARN TARAN	11KV	DS DIVN. RAYYA AT BEAS/D/ BEAS		0928F05	MESI	NON AMR	OK	31.03.2023		Category 2				2068668	1200-600/5	3,335	NA	Director/D	
B.1935	Border	TARN TARAN	11KV	DS DIVN. RAYYA AT BEAS/D/ BEAS		0928F04	RAILWAY STATION-II	AMR	OK	31.03.2023		Category 5-UPS				30312	400-200/5	9,312	NA	Director/D	
B.1936	Border	TARN TARAN	11KV	DS DIVN. RAYYA AT BEAS/D/ BEAS		0928F10	BEAS CITY	AMR	OK	31.03.2023		Category 1				11069760	400-200/5	9,545	NA	Director/D	
B.1937	Border	TARN TARAN	11KV	DS DIVN. RAYYA AT BEAS/D/ BEAS		0928F07	JODHEY	AMR	OK	31.03.2023		AP 3Phase 3Wire				9154415	900-450/5	2,564	NA	Director/D	
B.1938	Border	TARN TARAN	11KV	DS DIVN. RAYYA AT BEAS/D/ BEAS		0928F16	BABA BHATA	NON AMR	OK	31.03.2023		Category 5-UPS				P8802753	900-450/5	5,270	NA	Director/D	
B.1939	Border	TARN TARAN	11KV	DS DIVN. RAYYA AT BEAS/D/ BUTARI		C805F09	KHALCHIAN	NON AMR	OK	31.03.2023		AP 3Phase 3Wire				2067412	1200/577/1-1	2,477	NA	Director/D	
B.1940	Border	TARN TARAN	11KV	DS DIVN. RAYYA AT BEAS/D/ BUTARI		8903F04	SANGATPURA	NON AMR	OK	31.03.2023		AP 3Phase 3Wire				9153993	900-450/5	0,464	NA	Director/D	
B.1941	Border	TARN TARAN	11KV	DS DIVN. RAYYA AT BEAS/D/ BUTARI		8903F10	LONGHARA	NON AMR	OK	31.03.2023		AP 3Phase 3Wire				9154202	900-450/5	1,450	NA	Director/D	
B.1942	Border	TARN TARAN	11KV	DS DIVN. RAYYA AT BEAS/D/ BUTARI		8903F07	SUDHAR	NON AMR	OK	31.03.2023		AP 3Phase 3Wire				9140799	1200-600/5	1,503	NA	Director/D	
B.1943	Border	TARN TARAN	11KV	DS DIVN. RAYYA AT BEAS/D/ BUTARI		8903F12	SARIA	NON AMR	OK	31.03.2023		AP 3Phase 3Wire				24308	1200-600/5	1,504	NA	Director/D	
B.1944	Border	TARN TARAN	11KV	DS DIVN. RAYYA AT BEAS/D/ BUTARI		8903F05	WADALA	NON AMR	OK	31.03.2023		AP 3Phase 3Wire				3412	1200-600/5	1,535	NA	Director/D	
B.1945	Border	TARN TARAN	11KV	DS DIVN. RAYYA AT BEAS/D/ BUTARI		8903F15	SARJANWALI	NON AMR	OK	31.03.2023		AP 3Phase 3Wire				2067132	900-450/5	1,560	NA	Director/D	
B.1946	Border	TARN TARAN	11KV	DS DIVN. RAYYA AT BEAS/D/ BUTARI		8903F16	KALEKE	NON AMR	OK	31.03.2023		AP 3Phase 3Wire				11605198	900-450/5	1,642	NA	Director/D	
B.1947	Border	TARN TARAN	11KV	DS DIVN. RAYYA AT BEAS/D/ BUTARI		8903F16	MADEPUR	NON AMR	OK	31.03.2023		AP 3Phase 3Wire				9154057	900-450/5	1,798	NA	Director/D	
B.1948	Border	TARN TARAN	11KV	DS DIVN. RAYYA AT BEAS/D/ BUTARI		8903F11	BHALPUR PURBA	NON AMR	OK	31.03.2023		AP 3Phase 3Wire				11060903	900-450/5	1,836	NA	Director/D	
B.1949	Border	TARN TARAN	11KV	DS DIVN. RAYYA AT BEAS/D/ BUTARI		8903F08	KELAR	NON AMR	OK	31.03.2023		AP 3Phase 3Wire				8223214	1200-600/5	1,983	NA	Director/D	
B.1950	Border	TARN TARAN	11KV	DS DIVN. RAYYA AT BEAS/D/ BUTARI		8903F13	JALLUPUR	NON AMR	OK	31.03.2023		AP 3Phase 3Wire				11060899	900-450/5	1,991	NA	Director/D	
B.1951	Border	TARN TARAN	11KV	DS DIVN. RAYYA AT BEAS/D/ BUTARI		8903F09	DANUP	NON AMR	OK	31.03.2023		AP 3Phase 3Wire				8222898	1200-600/5	2,039	NA	Director/D	
B.1952	Border	TARN TARAN	11KV	DS DIVN. RAYYA AT BEAS/D/ BUTARI		8903F10	DANIAL	NON AMR	OK	31.03.2023		AP 3Phase 3Wire				910311	1200-600/5	3,287	NA	Director/D	
B.1953	Border	TARN TARAN	11KV	DS DIVN. RAYYA AT BEAS/D/ BUTARI		8903F17	BHORSI	NON AMR	OK	31.03.2023		AP 3Phase 3Wire				9153993	900-450/5	2,720	NA	Director/D	
B.1954	Border	TARN TARAN	11KV	DS DIVN. RAYYA AT BEAS/D/ BUTARI		8903F01	BANIA URBAN	NON AMR	OK	31.03.2023		Category 5-UPS				23693	1200-600/5	12,885	NA	Director/D	
B.1955	Border	TARN TARAN	11KV	DS DIVN. RAYYA AT BEAS/D/ BUTARI		8903F03	BUTARI URBAN	NON AMR	OK	31.03.2023		Category 5-UPS				33440	1200-600/5	14,036	NA	Director/D	
B.1956	Border	TARN TARAN	11KV	DS DIVN. RAYYA AT BEAS/D/ BUTARI		8903F02	RAYYA URBAN	AMR	OK	31.03.2023		Category 5-UPS				13104048	1200-600/5	15,650	NA	Director/D	
B.1957	Border	TARN TARAN	11KV	DS DIVN. RAYYA AT BEAS/D/ BUTARI		0939F12	BHARA	NON AMR	OK	31.03.2023		AP 3Phase 3Wire				73143193	900-450/5	1,344	NA	Director/D	
B.1958	Border	TARN TARAN	11KV	DS DIVN. RAYYA AT BEAS/D/ BUTARI		0939F06	DEREWAL(SAIDPURI)	NON AMR	OK	31.03.2023		AP 3Phase 3Wire				384	900-450/5	1,402	NA	Director/D	
B.1959	Border	TARN TARAN	11KV	DS DIVN. RAYYA AT BEAS/D/ BUTARI		0939F09	BARIANA	AMR	OK	31.03.2023		AP 3Phase 3Wire				2068575	900-450/5	1,574	NA	Director/D	
B.1960	Border	TARN TARAN	11KV	DS DIVN. RAYYA AT BEAS/D/ BUTARI		0939F07	JASPAL	NON AMR	OK	31.03.2023		AP 3Phase 3Wire				9154052	900-450/5	1,702	NA	Director/D	
B.1961	Border	TARN TARAN	11KV	DS DIVN. RAYYA AT BEAS/D/ BUTARI		0939F10	Singhpura	AMR	OK	31.03.2023		AP 3Phase 3Wire				11117123	900-450/5	2,003	NA	Director/D	
B.1962	Border	TARN TARAN	11KV	DS DIVN. RAYYA AT BEAS/D/ BUTARI		0939F13	Sarja UPS	NON AMR	OK	31.03.2023		Category 5-UPS				2068222	900-450/5	5,381	NA	Director/D	
B.1963	Border	TARN TARAN	11KV	DS DIVN. RAYYA AT BEAS/D/ BUTARI		8903F10	DERA BHAGATA	AMR	OK	31.03.2023		AP 3Phase 3Wire				13104043	600/577/1-1	1,870	NA	Director/D	
B.1964	Border	TARN TARAN	11KV	DS DIVN. RAYYA AT BEAS/D/ BUTARI		0820F04	DEHRWAL(TARSIKA)	AMR	OK	31.03.2023		AP 3Phase 3Wire				8222926	600/577/1-1	1,613	NA	Director/D	
B.1965	Border	TARN TARAN	11KV	DS DIVN. RAYYA AT BEAS/D/ MEHTA CHOWK		0837F09	Bhowal AP	NON AMR	OK	31.03.2023		AP 3Phase 3Wire				16194370	900-450/577/1-1	0,730	NA	Director/D	
B.1966	Border	TARN TARAN	11KV	DS DIVN. RAYYA AT BEAS/D/ MEHTA CHOWK		0927F18	Nawabpur	AMR	OK	31.03.2023		AP 3Phase 3Wire				2066746	1200-600/5	0,848	NA	Director/D	
B.1967	Border	TARN TARAN	11KV	DS DIVN. RAYYA AT BEAS																	

S.No	Zone	Circle	Voltage Level (kVA)	Division (kVA)	Sub-Division (kVA)	Feeder ID	Feeder Name	Feeder Metering Status (Metered/unmetered/AMR/AMI)	Status of Meter (Functional/Non-functional)	Metering Date	Date of last actual meter reading/communication	Feeder Type (Agr./Industrial/Mixed)	Status of Communication			Period from 01.04.2021 to 31.03.2022				Sales	Remarks (Source of data)
													% data received through automatically if feeder AMR/AMI	Number of hours when meter was unable to communicate in overall	Total Number of hours in the period	Meter S.No	CT/PT ratio	Import (kWh)	Export (kWh)		
B.2007	Border	TARN TARAN	11KV	DS DIVN. RAYYA AT BEAOS S/D NAGOKE		0929FL06	JALALABAD	AMR	OK	31.03.2023		AP 3Phase 3Wire	7336675	1200-600/5	2,818	NA	Director/D				
B.2008	Border	TARN TARAN	11KV	DS DIVN. RAYYA AT BEAOS S/D NAGOKE		0929FL07	DERA SOHAL	AMR	OK	31.03.2023		AP 3Phase 3Wire	6761897	1200-600/5	2,992	NA	Director/D				
B.2009	Border	TARN TARAN	11KV	DS DIVN. RAYYA AT BEAOS S/D NAGOKE		0929FL01	NAGOKI	AMR	OK	31.03.2023		AP 3Phase 3Wire	2066304	900-450/5	3,067	NA	Director/D				
B.2010	Border	TARN TARAN	11KV	DS DIVN. RAYYA AT BEAOS S/D NAGOKE		0929FL03	NAGOKI URBAN	AMR	OK	31.03.2023		Category 5-UPS	8202395	900-450/5	5,833	NA	Director/D				
B.2011	Border	TARN TARAN	11KV	DS DIVN. RAYYA AT BEAOS S/D NAGOKE		0929FL13	Mallah	AMR	OK	31.03.2023		Category 5-UPS	265656	900-450/5	9,904	NA	Director/D				
B.2012	Border	TARN TARAN	11KV	DS DIVN. RAYYA AT BEAOS S/D NAGOKE		0929FL10	MIANWIND URBAN	AMR	OK	31.03.2023		Category 5-UPS	7336475	900-450/5	11,508	NA	Director/D				
B.2013	Border	TARN TARAN	11KV	DS DIVN. RAYYA AT BEAOS S/D NAGOKE		0929FL11	Botekiri	NON AMR	OK	31.03.2023		Category 5-UPS	10282939	1200-600/5	12,740	NA	Director/D				
B.2014	Border	TARN TARAN	11KV	DS DIVN. RAYYA AT BEAOS S/D RAYYA		8903FL18	GARGREWAL	NON AMR	OK	31.03.2023		AP 3Phase 3Wire	9154000	900-450/5	0,966	NA	Director/D				
B.2015	Border	TARN TARAN	11KV	DS DIVN. RAYYA AT BEAOS S/D RAYYA		0903FL10	Macrowala	NON AMR	OK	31.03.2023		Category 2	10282873	900-450/5	4,995	NA	Director/D				
B.2016	Border	TARN TARAN	11KV	DS DIVN. RAYYA AT BEAOS S/D RAYYA		0926FL01	PHERLIMAN	AMR	OK	31.03.2023		AP 3Phase 3Wire	4219659	400-200/5-5	1,812	NA	Director/D				
B.2017	Border	TARN TARAN	11KV	DS DIVN. RAYYA AT BEAOS S/D RAYYA		0926FL09	BHALAJPUR	NON AMR	OK	31.03.2023		AP 3Phase 3Wire	11069728	400-200/5-5	2,020	NA	Director/D				
B.2018	Border	TARN TARAN	11KV	DS DIVN. RAYYA AT BEAOS S/D RAYYA		0926FL06	BHALOJALA	NON AMR	OK	31.03.2023		AP 3Phase 3Wire	10282976	1200-600/5	2,242	NA	Director/D				
B.2019	Border	TARN TARAN	11KV	DS DIVN. RAYYA AT BEAOS S/D RAYYA		0926FL02	KOT MEHTAB URBAN	NON AMR	OK	31.03.2023		Category 5-UPS	2067991	1200-600/5	13,587	NA	Director/D				
B.2020	Border	TARN TARAN	11KV	DS DIVN. RAYYA AT BEAOS S/D RAYYA		0929FL03	RAYYA BACK FEEDING	NON AMR	OK	31.03.2023		Category 1	9154037	1200-600/5	16,735	NA	Director/D				
B.2021	Border	TARN TARAN	11KV	DS DIVN. RAYYA AT BEAOS S/D RAYYA		0933FL09	LIDHAR	AMR	OK	31.03.2023		AP 3Phase 3Wire	73171334	900-450/5	1,258	NA	Director/D				
B.2022	Border	TARN TARAN	11KV	DS DIVN. RAYYA AT BEAOS S/D RAYYA		0933FL11	LIDHAR	NON AMR	OK	31.03.2023		Category 1	5295585	900-450/5	1,348	NA	Director/D				
B.2023	Border	TARN TARAN	11KV	DS DIVN. RAYYA AT BEAOS S/D RAYYA		0933FL10	NILJAR	NON AMR	OK	31.03.2023		AP 3Phase 3Wire	73171313	900-450/5	1,419	NA	Director/D				
B.2024	Border	TARN TARAN	11KV	DS DIVN. RAYYA AT BEAOS S/D RAYYA		0933FL12	HASSANPUR	NON AMR	OK	31.03.2023		AP 3Phase 3Wire	6761947	900-450/5	1,468	NA	Director/D				
B.2025	Border	TARN TARAN	11KV	DS DIVN. RAYYA AT BEAOS S/D RAYYA		0933FL08	ANIVATPUR 66KV LIDHAR	NON AMR	OK	31.03.2023		AP 3Phase 3Wire	36652	900-450/5	1,560	NA	Director/D				
B.2026	Border	TARN TARAN	11KV	DS DIVN. RAYYA AT BEAOS S/D RAYYA		0933FL06	GHAUGE	NON AMR	OK	31.03.2023		Category 2	73742	900-450/5	1,513	NA	Director/D				
B.2027	Border	TARN TARAN	11KV	DS DIVN. RAYYA AT BEAOS S/D RAYYA		0933FL07	EHOKIPUR	NON AMR	OK	31.03.2023		AP 3Phase 3Wire	36983	900-450/5	1,825	NA	Director/D				
B.2028	Border	TARN TARAN	11KV	DS DIVN. RAYYA AT BEAOS S/D RAYYA		0933FL05	Tong	AMR	OK	31.03.2023		AP 3Phase 3Wire	23787	900-450/5	2,041	NA	Director/D				
B.2029	Border	TARN TARAN	11KV	DS DIVN. RAYYA AT BEAOS S/D RAYYA		0933FL14	RAPU NAROTAMPUR	AMR	OK	31.03.2023		AP 3Phase 3Wire	9140796	900-450/5	2,140	NA	Director/D				
B.2030	Border	TARN TARAN	11KV	DS DIVN. RAYYA AT BEAOS S/D RAYYA		0933FL13	BAHADARPUR	AMR	OK	31.03.2023		Category 5-UPS	9140834	900-450/5	7,750	NA	Director/D				
B.2031	Border	TARN TARAN	11KV	DS S/U DIVN. TARN TARAS S/D FATEHABAD		0905FL15	MAND RURAL	NON AMR	OK	31.03.2023		AP 3Phase 3Wire	6072203	900-450/5	0,871	NA	Director/D				
B.2032	Border	TARN TARAN	11KV	DS S/U DIVN. TARN TARAS S/D FATEHABAD		0905FL12	BKJOJWALI	NON AMR	OK	31.03.2023		AP 3Phase 3Wire	9534995	900-450/5	1,015	NA	Director/D				
B.2033	Border	TARN TARAN	11KV	DS S/U DIVN. TARN TARAS S/D FATEHABAD		0905FL01	CHHABRI SAHIB	NON AMR	OK	31.03.2023		AP 3Phase 3Wire	23644	900-450/5	1,167	NA	Director/D				
B.2034	Border	TARN TARAN	11KV	DS S/U DIVN. TARN TARAS S/D FATEHABAD		0905FL02	CHHABRI SAHIB NO.2	AMR	OK	31.03.2023		AP 3Phase 3Wire	15196563	900-450/5	1,417	NA	Director/D				
B.2035	Border	TARN TARAN	11KV	DS S/U DIVN. TARN TARAS S/D FATEHABAD		0905FL04	MANADAKE	AMR	OK	31.03.2023		AP 3Phase 3Wire	4183	900-450/5	1,465	NA	Director/D				
B.2036	Border	TARN TARAN	11KV	DS S/U DIVN. TARN TARAS S/D FATEHABAD		0905FL09	KHELA No. 1	NON AMR	OK	31.03.2023		AP 3Phase 3Wire	2066251	900-450/5	1,518	NA	Director/D				
B.2037	Border	TARN TARAN	11KV	DS S/U DIVN. TARN TARAS S/D FATEHABAD		0905FL06	FATEHABAD RURAL	NON AMR	OK	31.03.2023		AP 3Phase 3Wire	23701	900-450/5	1,689	NA	Director/D				
B.2038	Border	TARN TARAN	11KV	DS S/U DIVN. TARN TARAS S/D FATEHABAD		0905FL14	KHELA NO.2	NON AMR	OK	31.03.2023		AP 3Phase 3Wire	223699	900-450/5	1,834	NA	Director/D				
B.2039	Border	TARN TARAN	11KV	DS S/U DIVN. TARN TARAS S/D FATEHABAD		0905FL03	BHAROWAL RURAL	AMR	OK	31.03.2023		AP 3Phase 3Wire	2066686	900-450/5	1,991	NA	Director/D				
B.2040	Border	TARN TARAN	11KV	DS S/U DIVN. TARN TARAS S/D FATEHABAD		0905FL08	KHAWASPUR	NON AMR	OK	31.03.2023		AP 3Phase 3Wire	7030164	900-450/5	2,067	NA	Director/D				
B.2041	Border	TARN TARAN	11KV	DS S/U DIVN. TARN TARAS S/D FATEHABAD		0905FL07	BHAIL	AMR	OK	31.03.2023		AP 3Phase 3Wire	23630	900-450/5	2,285	NA	Director/D				
B.2042	Border	TARN TARAN	11KV	DS S/U DIVN. TARN TARAS S/D FATEHABAD		0905FL11	VAL PUNJ	NON AMR	OK	31.03.2023		AP 3Phase 3Wire	2066608	900-450/5	2,311	NA	Director/D				
B.2043	Border	TARN TARAN	11KV	DS S/U DIVN. TARN TARAS S/D FATEHABAD		0905FL13	BICHN UPS	NON AMR	OK	31.03.2023		Category 5-UPS	9534441	900-450/5	6,205	NA	Director/D				
B.2044	Border	TARN TARAN	11KV	DS S/U DIVN. TARN TARAS S/D FATEHABAD		0905FL10	BHAROWAL URBAN	NON AMR	OK	31.03.2023		Category 5-UPS	6740723	900-450/5	10,162	NA	Director/D				
B.2045	Border	TARN TARAN	11KV	DS S/U DIVN. TARN TARAS S/D FATEHABAD		0905FL05	FATEHABAD URBAN	AMR	OK	31.03.2023		Category 5-UPS	23616	900-450/5	11,550	NA	Director/D				
B.2046	Border	TARN TARAN	11KV	DS S/U DIVN. TARN TARAS S/D FATEHABAD		0903FL24	SILVERA SHAHIB	NON AMR	OK	31.03.2023		AP 3Phase 3Wire	10281287	900-450/5	1,538	NA	Director/D				
B.2047	Border	TARN TARAN	11KV	DS S/U DIVN. TARN TARAS S/D FATEHABAD		0903FL16	DHUNDA	NON AMR	OK	31.03.2023		AP 3Phase 3Wire	7030144	900-450/5	2,121	NA	Director/D				
B.2048	Border	TARN TARAN	11KV	DS S/U DIVN. TARN TARAS S/D FATEHABAD		0903FL07	HINDER A UPS	NON AMR	OK	31.03.2023		Category 5-UPS	10282880	900-450/5	4,869	NA	Director/D				
B.2049	Border	TARN TARAN	11KV	DS S/U DIVN. TARN TARAS S/D FATEHABAD		0933FL15	KHELA NO.2	AMR	OK	31.03.2023		AP 3Phase 3Wire	9153634	900-450/5	1,795	NA	Director/D				
B.2050	Border	TARN TARAN	11KV	DS S/U DIVN. TARN TARAS S/D FATEHABAD		0933FL04	TUR	NON AMR	OK	31.03.2023		AP 3Phase 3Wire	9153628	900-450/5	1,907	NA	Director/D				
B.2051	Border	TARN TARAN	11KV	DS S/U DIVN. TARN TARAS S/D FATEHABAD		0933FL06	oJal	NON AMR	OK	31.03.2023		AP 3Phase 3Wire	9154094	900-450/5	1,991	NA	Director/D				
B.2052	Border	TARN TARAN	11KV	DS S/U DIVN. TARN TARAS S/D FATEHABAD		0933FL22	JAMA Rai Rural	NON AMR	OK	31.03.2023		AP 3Phase 3Wire	1116881	900-450/5	2,014	NA	Director/D				
B.2053	Border	TARN TARAN	11KV	DS S/U DIVN. TARN TARAS S/D FATEHABAD		0933FL05	JAMA Rai Rural	NON AMR	OK	31.03.2023		Category 5-UPS	11069768	900-450/5	6,106	NA	Director/D				
B.2054	Border	TARN TARAN	11KV	DS S/U DIVN. TARN TARAS S/D FATEHABAD		8904FL14	MEETAN SINGH	NON AMR	OK	31.03.2023		AP 3Phase 3Wire	7336476	900-450/5	1,473	NA	Director/D				
B.2055	Border	TARN TARAN	11KV	DS S/U DIVN. TARN TARAS S/D FATEHABAD		8904FL18	Hatia	NON AMR	OK	31.03.2023		AP 3Phase 3Wire	2066673	900-450/5	2,371	NA	Director/D				
B.2056	Border	TARN TARAN	11KV	DS S/U DIVN. TARN TARAS S/D FATEHABAD		8904FL03	LALPUR	AMR	OK	31.03.2023		AP 3Phase 3Wire	7336537	1200-600/5	2,652	NA	Director/D				
B.2057	Border	TARN TARAN	11KV	DS S/U DIVN. TARN TARAS S/D FATEHABAD		8904FL19	LALPUR HATTA UPS	AMR	OK	31.03.2023		Category 5-UPS	15196125	1200-600/5	4,638	NA	Director/D				
B.2058	Border	TARN TARAN	11KV	DS S/U DIVN. TARN TARAS S/D KHADDOOR SAHIB		0903FL12	INDIAN OIL	NON AMR	OK	31.03.2023		Category 4	4060	900-450/5	0,948	NA	Director/D				
B.2059	Border	TARN TARAN	11KV	DS S/U DIVN. TARN TARAS S/D KHADDOOR SAHIB		0903FL04	GONDWAL RURAL	AMR	OK	31.03.2023		AP 3Phase 3Wire	8232131	900-450/5	1,005	NA	Director/D				
B.2060	Border	TARN TARAN	11KV	DS S/U DIVN. TARN TARAS S/D KHADDOOR SAHIB		0903FL13	Kendri Sudar Ghar	NON AMR	OK	31.03.2023		Category 2	223699	900-450/5	1,512	NA	Director/D				
B.2061	Border	TARN TARAN	11KV	DS S/U DIVN. TARN TARAS S/D KHADDOOR SAHIB		0903FL02	BAWA SHEER	NON AMR	OK	31.03.2023		Category 2	10282875	900-450/5	2,156	NA	Director/D				
B.2062	Border	TARN TARAN	11KV	DS S/U DIVN. TARN TARAS S/D KHADDOOR SAHIB		0903FL08	PINDAN	AMR	OK	31.03.2023		AP 3Phase 3Wire	2067436	900-450/5	2,249	NA	Director/D				
B.2063	Border	TARN TARAN	11KV	DS S/U DIVN. TARN TARAS S/D KHADDOOR SAHIB		0903FL11	NEROLAC	NON AMR	OK	31.03.2023		Category 2	2833	900-450/5	4,763	NA	Director/D				
B.2064	Border	TARN TARAN	11KV	DS S/U DIVN. TARN TARAS S/D KHADDOOR SAHIB		0903FL14	GHAT SAHIB URBAN	NON AMR	OK	31.03.2023		Category 1	9534992	900-450/5	5,052	NA	Director/D				
B.2065	Border	TARN TARAN	11KV	DS S/U DIVN. TARN TARAS S/D KHADDOOR SAHIB		0903FL03	ADON RURAL	NON AMR	OK	31.03.2023		Category 2	10282878	900-450/5	6,913	NA	Director/D				
B.2066	Border	TARN TARAN	11KV	DS S/U DIVN. TARN TARAS S/D KHADDOOR SAHIB		0903FL01	GONDWAL Urban	AMR	OK	31.03.2023		Category 5-UPS	10282819	900-450/5	11,229	NA	Director/D				
B.2067	Border	TARN TARAN	11KV	DS S/U DIVN. TARN TARAS S/D KHADDOOR SAHIB		0904FL08	Darbar Sahib	AMR	OK	31.03.2023		Category 1	32238	900-450/577/1-1							

S.No	Zone	Circle	Voltage Level (kVA)	Division (kVA)	Sub-Division (kVA)	Feeder ID	Feeder Name	Feeder Metering Status (Metered/unmetered/AMR/AM)	Status of Meter (Functional/Non-Functional)	Metering Date (Date of last actual meter reading/communication)	Feeder Type (Agr/Industrial/Mixed)	Status of Communication			Period from 01.04.2021 to 31.03.2022				Sales	Remarks (Source of data)
												% data received through automatically if feeder AMR/AM	Number of hours when meter was unable to communicate in overall	Total Number of hours in the period	Meter S.No	CT/PT ratio	Import (kWh)	Export (kWh)		
B.2104	Border	TARN TARAN	11KV	DS S/U DIVN. TARN TARAN	S/D NAUSHERA PANNUA	D901FL20	Chambal	AMR	OK	31.03.2023	AP 3Phase 3Wire				11117014	900-450/5	4.062	NA	Director/D	
B.2105	Border	TARN TARAN	11KV	DS S/U DIVN. TARN TARAN	S/D NAUSHERA PANNUA	F112D901	FELLOE	NON AMR	OK	31.03.2023	Category 5-UPS				1321	1200-600/5	6.190	NA	Director/D	
B.2106	Border	TARN TARAN	11KV	DS S/U DIVN. TARN TARAN	S/D NAUSHERA PANNUA	D901FL19	JAWANDY	NON AMR	OK	31.03.2023	Category 5-UPS				11117306	900-450/5	6.598	NA	Director/D	
B.2107	Border	TARN TARAN	11KV	DS S/U DIVN. TARN TARAN	S/D NAUSHERA PANNUA	D901FL15	TRAYATHAN 3 W URBAN	NON AMR	OK	31.03.2023	Category 5-UPS				983499	900-450/5	7.530	NA	Director/D	
B.2108	Border	TARN TARAN	11KV	DS S/U DIVN. TARN TARAN	S/D NAUSHERA PANNUA	D901FL16	NAUSHERA PANNUN URBAN	NON AMR	OK	31.03.2023	Category 1				5437512	1200-600/5	9.451	NA	Director/D	
B.2109	Border	TARN TARAN	11KV	DS S/U DIVN. TARN TARAN	S/D NAUSHERA PANNUA	D901FL17	SHERON UPS	AMR	OK	31.03.2023	Category 5-UPS				5437740	1200-600/5	10.158	NA	Director/D	
B.2110	Border	TARN TARAN	11KV	DS S/U DIVN. TARN TARAN	S/D S/U TARN TARN	D02FL11	BUGA	AMR	OK	31.03.2023	AP 3Phase 3Wire				9534397	1200-600/5	2.152	NA	Director/D	
B.2111	Border	TARN TARAN	11KV	DS S/U DIVN. TARN TARAN	S/D S/U TARN TARN	C002FL08	chutala	AMR	OK	31.03.2023	AP 3Phase 3Wire				2066314	900-450/5	2.704	NA	Director/D	
B.2112	Border	TARN TARAN	11KV	DS S/U DIVN. TARN TARAN	S/D S/U TARN TARN	D94FL07	BANWALPUR SERON	AMR	OK	31.03.2023	AP 3Phase 3Wire				25789	900-450/5	0.791	NA	Director/D	
B.2113	Border	TARN TARAN	11KV	DS S/U DIVN. TARN TARAN	S/D S/U TARN TARN	D94FL06	COURT COMPLEX	NON AMR	OK	31.03.2023	Category 1				593618	900-450/5	1.054	NA	Director/D	
B.2114	Border	TARN TARAN	11KV	DS S/U DIVN. TARN TARAN	S/D S/U TARN TARN	D00DF02	ALADINPUR RURAL	NON AMR	OK	31.03.2023	AP 3Phase 3Wire				593619	900-450/5	1.530	NA	Director/D	
B.2115	Border	TARN TARAN	11KV	DS S/U DIVN. TARN TARAN	S/D S/U TARN TARN	D00DF03	DUGALWALA NO2	AMR	OK	31.03.2023	AP 3Phase 3Wire				593621	900-450/5	1.958	NA	Director/D	
B.2116	Border	TARN TARAN	11KV	DS S/U DIVN. TARN TARAN	S/D S/U TARN TARN	D94FL02	RASULPUR	AMR	OK	31.03.2023	Category 1				8582367	900-450/5	2.263	NA	Director/D	
B.2117	Border	TARN TARAN	11KV	DS S/U DIVN. TARN TARAN	S/D S/U TARN TARN	D94FL05	Pogdi	NON AMR	OK	31.03.2023	Category 5-UPS				593623	900-450/5	8.835	NA	Director/D	
B.2118	Border	TARN TARAN	11KV	DS S/U DIVN. TARN TARAN	S/D S/U TARN TARN	D00DF01	JODHPUR LPS	AMR	OK	31.03.2023	Category 5-UPS				593622	900-450/5	14.107	NA	Director/D	
B.2119	Border	TARN TARAN	11KV	DS S/U DIVN. TARN TARAN	S/D S/U TARN TARN	D906FL11	DUGALWALA	AMR	OK	31.03.2023	AP 3Phase 3Wire				2066816	1200-600/5	1.322	NA	Director/D	
B.2120	Border	TARN TARAN	11KV	DS S/U DIVN. TARN TARAN	S/D S/U TARN TARN	D906FL10	KALER	AMR	OK	31.03.2023	AP 3Phase 3Wire				7349822	1200-600/5	1.515	NA	Director/D	
B.2121	Border	TARN TARAN	11KV	DS S/U DIVN. TARN TARAN	S/D S/U TARN TARN	D906FL03	RASULPUR	AMR	OK	31.03.2023	AP 3Phase 3Wire				8222481	1200-600/5	1.704	NA	Director/D	
B.2122	Border	TARN TARAN	11KV	DS S/U DIVN. TARN TARAN	S/D S/U TARN TARN	D906FL08	BATH	AMR	OK	31.03.2023	AP 3Phase 3Wire				2066328	1200-600/5	1.859	NA	Director/D	
B.2123	Border	TARN TARAN	11KV	DS S/U DIVN. TARN TARAN	S/D S/U TARN TARN	D906FL17	CHURU NANK HOSPITAL	AMR	OK	31.03.2023	Category 4				12093588	1200-600/5	1.865	NA	Director/D	
B.2124	Border	TARN TARAN	11KV	DS S/U DIVN. TARN TARAN	S/D S/U TARN TARN	D906FL07	MALIA	AMR	OK	31.03.2023	AP 3Phase 3Wire				7042926	1200-600/5	2.329	NA	Director/D	
B.2125	Border	TARN TARAN	11KV	DS S/U DIVN. TARN TARAN	S/D S/U TARN TARN	D906FL01	BAGRAN	AMR	OK	31.03.2023	AP 3Phase 3Wire				8223377	1200-600/5	2.393	NA	Director/D	
B.2126	Border	TARN TARAN	11KV	DS S/U DIVN. TARN TARAN	S/D S/U TARN TARN	D906FL06	FOCAL POINT UPS	AMR	OK	31.03.2023	Category 5-UPS				12527383	1200-600/5	4.634	NA	Director/D	
B.2127	Border	TARN TARAN	11KV	DS S/U DIVN. TARN TARAN	S/D S/U TARN TARN	D906FL13	KADD GILL UPS	NON AMR	OK	31.03.2023	Category 5-UPS				9154085	1200-600/5	6.718	NA	Director/D	
B.2128	Border	TARN TARAN	11KV	DS S/U DIVN. TARN TARAN	S/D S/U TARN TARN	D906FL18	CHINDWAL ROAD	AMR	OK	31.03.2023	Category 5-UPS				7336770	1200-600/5	8.756	NA	Director/D	
B.2129	Border	TARN TARAN	11KV	DS S/U DIVN. TARN TARAN	S/D S/U TARN TARN	D906FL19	Sarhali Road	AMR	OK	31.03.2023	Category 1				58386	1200-600/5	9.286	NA	Director/D	
B.2130	Border	TARN TARAN	11KV	DS S/U DIVN. TARN TARAN	S/D S/U TARN TARN	D906FL02	RAILWAY ROAD UPS	AMR	OK	31.03.2023	Category 5-UPS				11052025	1200-600/5	9.909	NA	Director/D	
B.2131	Border	TARN TARAN	11KV	DS S/U DIVN. TARN TARAN	S/D S/U TARN TARN	D906FL04	24 HRS CHUTALA	AMR	OK	31.03.2023	Category 5-UPS				11051968	1200-600/5	10.398	NA	Director/D	
B.2132	Border	TARN TARAN	11KV	DS S/U DIVN. TARN TARAN	S/D S/U TARN TARN	D906FL14	JANDIALA ROAD UPS	AMR	OK	31.03.2023	Category 5-UPS				88834048	1200-600/5	15.914	NA	Director/D	
B.2133	Border	TARN TARAN	11KV	DS S/U DIVN. TARN TARAN	S/D S/U TARN TARN	D913FL07	SANABPUR	AMR	OK	31.03.2023	AP 3Phase 3Wire				9149096	900-450/5	4.105	NA	Director/D	
B.2134	Border	TARN TARAN	11KV	DS S/U DIVN. TARN TARAN	S/D S/U TARN TARN	D94FL07	BATH-	NON AMR	OK	31.03.2023	AP 3Phase 3Wire				8223380	1200-600/5	0.572	NA	Director/D	
B.2135	Border	TARN TARAN	11KV	DS S/U DIVN. TARN TARAN	S/D S/U TARN TARN	D942FL01	BAGRAN KHURD	NON AMR	OK	31.03.2023	AP 3Phase 3Wire				232758	1200-600/5	1.177	NA	Director/D	
B.2136	Border	TARN TARAN	11KV	DS S/U DIVN. TARN TARAN	S/D S/U TARN TARN	D942FL03	BHULLAR	NON AMR	OK	31.03.2023	AP 3Phase 3Wire				23618	1200-600/5	1.542	NA	Director/D	
B.2137	Border	TARN TARAN	11KV	DS S/U DIVN. TARN TARAN	S/D S/U TARN TARN	D942FL02	BABA GURMUKH SINGH	NON AMR	OK	31.03.2023	AP 3Phase 3Wire				23617	1200-600/5	1.729	NA	Director/D	
B.2138	Border	TARN TARAN	11KV	DS S/U DIVN. TARN TARAN	S/D S/U TARN TARN	D942FL05	DEO RURAL	NON AMR	OK	31.03.2023	AP 3Phase 3Wire				23620	1200-600/5	1.939	NA	Director/D	
B.2139	Border	TARN TARAN	11KV	DS S/U DIVN. TARN TARAN	S/D S/U TARN TARN	D942FL06	JAWANDY KHURD	NON AMR	OK	31.03.2023	Category 5-UPS				15199029	1200-600/5	6.589	NA	Director/D	
B.2140	Border	TARN TARAN	11KV	DS S/U DIVN. TARN TARAN	S/D S/U TARN TARN	D902FL09	BABA DALER SINGH	NON AMR	OK	31.03.2023	Category 1				2335401	1200-600/5	0.865	NA	Director/D	
B.2141	Border	TARN TARAN	11KV	DS S/U DIVN. TARN TARAN	S/D S/U TARN TARN	8FL08	MALCHAK	AMR	OK	31.03.2023	AP 3Phase 3Wire				11116784	1200-600/5	1.088	NA	Director/D	
B.2142	Border	TARN TARAN	11KV	DS S/U DIVN. TARN TARAN	S/D S/U TARN TARN	8FL10	BANGALPUR	NON AMR	OK	31.03.2023	AP 3Phase 3Wire				11116861	900-450/5	1.413	NA	Director/D	
B.2143	Border	TARN TARAN	11KV	DS S/U DIVN. TARN TARAN	S/D S/U TARN TARN	D902FL08	JHANDER RURAL	NON AMR	OK	31.03.2023	AP 3Phase 3Wire				6761985	1200-600/5	1.901	NA	Director/D	
B.2144	Border	TARN TARAN	11KV	DS S/U DIVN. TARN TARAN	S/D S/U TARN TARN	D902FL06	RASHIANA	NON AMR	OK	31.03.2023	AP 3Phase 3Wire				7336372	900-450/5	2.169	NA	Director/D	
B.2145	Border	TARN TARAN	11KV	DS S/U DIVN. TARN TARAN	S/D S/U TARN TARN	8FL13	Naurangabad Rural	NON AMR	OK	31.03.2023	AP 3Phase 3Wire				11117071	1200-600/5	2.994	NA	Director/D	
B.2146	Border	TARN TARAN	11KV	DS S/U DIVN. TARN TARAN	S/D S/U TARN TARN	8FL18	MALCHURH	AMR	OK	31.03.2023	AP 3Phase 3Wire				7002971	900-450/5	3.309	NA	Director/D	
B.2147	Border	TARN TARAN	11KV	DS S/U DIVN. TARN TARAN	S/D S/U TARN TARN	D902FL02	NAURANGABAD UPS	AMR	OK	31.03.2023	Category 5-UPS				11117092	900-450/5	14.669	NA	Director/D	
B.2148	Central	CITY EAST LUDHIANA	11KV	DS CITY CEN. (SPS) DIVN	TECH UNIT-I DARESI	D001FL29	Subash Nagar Feeder	AMR	OK	31.03.2023	Category 1				33758	1200/5771-1-1	6.949	NA	Director/D	
B.2149	Central	CITY EAST LUDHIANA	11KV	DS CITY CEN. (SPS) DIVN	TECH UNIT-I DARESI	D001FL30	Chand Cinema	NON AMR	OK	31.03.2023	Category 1				16199579	1200/5771-1-1	8.301	NA	Director/D	
B.2150	Central	CITY EAST LUDHIANA	11KV	DS CITY CEN. (SPS) DIVN	TECH UNIT-I DARESI	D001FL01	MADHO PURI	NON AMR	OK	31.03.2023	Category 1				14279280	1200/5771-1-1	8.828	NA	Director/D	
B.2151	Central	CITY EAST LUDHIANA	11KV	DS CITY CEN. (SPS) DIVN	TECH UNIT-I DARESI	D001FL20	PATIALA HOUSE	NON AMR	OK	31.03.2023	Category 1				14479277	1200/5771-1-1	8.866	NA	Director/D	
B.2152	Central	CITY EAST LUDHIANA	11KV	DS CITY CEN. (SPS) DIVN	TECH UNIT-I DARESI	D001FL26	Shupala	NON AMR	OK	31.03.2023	Category 1				14279286	1200/5771-1-1	9.073	NA	Director/D	
B.2153	Central	CITY EAST LUDHIANA	11KV	DS CITY CEN. (SPS) DIVN	TECH UNIT-I DARESI	D001FL16	SAMRALA ROAD	NON AMR	OK	31.03.2023	Category 1				12479706	1200/5771-1-1	9.683	NA	Director/D	
B.2154	Central	CITY EAST LUDHIANA	11KV	DS CITY CEN. (SPS) DIVN	TECH UNIT-I DARESI	D001FL17	BRAHM PURI	NON AMR	OK	31.03.2023	Category 1				12479854	1200/5771-1-1	11.745	NA	Director/D	
B.2155	Central	CITY EAST LUDHIANA	11KV	DS CITY CEN. (SPS) DIVN	TECH UNIT-I DARESI	D001FL13	BASTI FEEDER	AMR	OK	31.03.2023	Category 1				1494	1200/5771-1-1	12.252	NA	Director/D	
B.2156	Central	CITY EAST LUDHIANA	11KV	DS CITY CEN. (SPS) DIVN	TECH UNIT-II CHAURA BAZAAR	D001FL-5	PNK PLAZA	AMR	OK	31.03.2023	Category 1				15196581	1200/5771-1-1	2.695	NA	Director/D	
B.2157	Central	CITY EAST LUDHIANA	11KV	DS CITY CEN. (SPS) DIVN	TECH UNIT-II CHAURA BAZAAR	D001FL-3	THAKUR	AMR	OK	31.03.2023	Category 1				15196078	1200/5771-1-1	4.914	NA	Director/D	
B.2158	Central	CITY EAST LUDHIANA	11KV	DS CITY CEN. (SPS) DIVN	TECH UNIT-II CHAURA BAZAAR	D001FL06	Phulka Dwara	AMR	OK	31.03.2023	Category 1				15199031	1200/5771-1-1	5.963	NA	Director/D	
B.2159	Central	CITY EAST LUDHIANA	11KV	DS CITY CEN. (SPS) DIVN	TECH UNIT-II CHAURA BAZAAR	D001FL-3	DIVISION-3	AMR	OK	31.03.2023	Category 1				15196195	1200/5771-1-1	10.755	NA	Director/D	
B.2160	Central	CITY EAST LUDHIANA	11KV	DS CITY CEN. (SPS) DIVN	TECH UNIT-II CHAURA BAZAAR	D001FL4	GIRIAGARH CHOWNK	AMR	OK	31.03.2023	Category 1				15196112	1200/5771-1-1	10.770	NA	Director/D	
B.2161	Central	CITY EAST LUDHIANA	11KV	DS CITY CEN. (SPS) DIVN	TECH UNIT-II CHAURA BAZAAR	D001FL-1	IQBAL NAGAR	NON AMR												

S.No	Zone	Circle	Voltage Level (kVA)	Division (kVA)	Sub-Division (kVA)	Feeder ID	Feeder Name	Feeder Metering Status (Metred/unmetred/AMR/AM)	Status of Meter (Functional/Non-Functional)	Metering Date	Date of last actual meter reading/communication	Feeder Type (Agr/Industrial/Mixed)	Status of Communication			Period from 01.04.2021 to 31.03.2022			Sales	Remarks (Source of data)
													% data received through automatically if feeder AMR/AM	Number of hours when meter was unable to communicate in overall	Total Number of hours in the period	Meter S.No	CT/Ratio	Import (kU)		
B.2201	Central	CITY EAST LUDHIANA	11KV	D5 CMC (SPL) DIVN.	TECH. UNIT-II CMC (SPL)	D007FL00	NAHAR SPG	NON AMR	OK	31.03.2023		Category 2				10281186	1200/577/1-1-1	11.111	NA	Director/D
B.2202	Central	CITY EAST LUDHIANA	11KV	D5 CMC (SPL) DIVN.	TECH. UNIT-II CMC (SPL)	D007FL07	pearl	NON AMR	OK	31.03.2023		Category 2				12479707	1200/577/1-1-1	12.926	NA	Director/D
B.2203	Central	CITY EAST LUDHIANA	11KV	D5 CMC (SPL) DIVN.	TECH. UNIT-II CMC (SPL)	D007FL12	TUBEWELL	NON AMR	OK	31.03.2023		Category 2				12479711	1200/577/1-1-1	13.851	NA	Director/D
B.2204	Central	CITY EAST LUDHIANA	11KV	D5 CMC (SPL) DIVN.	TECH. UNIT-II CMC (SPL)	D007FL10	TECH. UNIT-II CMC (SPL)	AMR	OK	31.03.2023		Category 2				12479710	1200/577/1-1-1	14.353	NA	Director/D
B.2205	Central	CITY EAST LUDHIANA	11KV	D5 CMC (SPL) DIVN.	TECH. UNIT-II CMC (SPL)	D007FL15	KALASHI NAGAR	NON AMR	OK	31.03.2023		Category 2				12479627	1200/577/1-1-1	15.061	NA	Director/D
B.2206	Central	CITY EAST LUDHIANA	11KV	D5 CMC (SPL) DIVN.	TECH. UNIT-II CMC (SPL)	D007FL14	RAJ SANDEEP	NON AMR	OK	31.03.2023		Category 2				12479631	1200/577/1-1-1	15.987	NA	Director/D
B.2207	Central	CITY EAST LUDHIANA	11KV	D5 CMC (SPL) DIVN.	TECH. UNIT-II CMC (SPL)	D014FL13	SURAJ INDUSTRY	AMR	OK	31.03.2023		Category 4				12092498	1200/577/1-1-1	0.000	NA	Director/D
B.2208	Central	CITY EAST LUDHIANA	11KV	D5 CMC (SPL) DIVN.	TECH. UNIT-II CMC (SPL)	D014FL14	GIRISH MANCHANDA	AMR	OK	31.03.2023		Category 4				478	1200/577/1-1-1	0.647	NA	Director/D
B.2209	Central	CITY EAST LUDHIANA	11KV	D5 CMC (SPL) DIVN.	TECH. UNIT-II CMC (SPL)	D014FL19	11 KV DHOKA MOHALLA	NON AMR	OK	31.03.2023		Category 1				23580	1200/577/1-1-1	7.631	NA	Director/D
B.2210	Central	CITY EAST LUDHIANA	11KV	D5 CMC (SPL) DIVN.	TECH. UNIT-II CMC (SPL)	D014FL20	ORIENTAL	AMR	OK	31.03.2023		Category 4				2067685	1200/577/1-1-1	8.494	NA	Director/D
B.2211	Central	CITY EAST LUDHIANA	11KV	D5 CMC (SPL) DIVN.	TECH. UNIT-II CMC (SPL)	D014FL12	G ARIAN DEV NAGAR	AMR	OK	31.03.2023		Category 4				2067123	1200/577/1-1-1	11.381	NA	Director/D
B.2212	Central	CITY EAST LUDHIANA	11KV	D5 CMC (SPL) DIVN.	TECH. UNIT-II CMC (SPL)	D014FL21	VISHAKMA NAGAR	NON AMR	OK	31.03.2023		Category 1				16199459	1200/577/1-1-1	11.786	NA	Director/D
B.2213	Central	CITY EAST LUDHIANA	11KV	D5 CMC (SPL) DIVN.	TECH. UNIT-II CMC (SPL)	D014FL04	SHIVAJI NAGAR	NON AMR	OK	31.03.2023		Category 1				2066528	1200/577/1-1-1	12.025	NA	Director/D
B.2214	Central	CITY EAST LUDHIANA	11KV	D5 CMC (SPL) DIVN.	TECH. UNIT-II CMC (SPL)	D014FL10	B DEEP SINGH NAGAR	AMR	OK	31.03.2023		Category 2				2047086	1200/577/1-1-1	12.857	NA	Director/D
B.2215	Central	CITY EAST LUDHIANA	11KV	D5 CMC (SPL) DIVN.	TECH. UNIT-II CMC (SPL)	D014FL06	MOTI BAGAR	NON AMR	OK	31.03.2023		Category 2				5566	1200/577/1-1-1	13.328	NA	Director/D
B.2216	Central	CITY EAST LUDHIANA	11KV	D5 CMC (SPL) DIVN.	TECH. UNIT-II CMC (SPL)	D014FL07	SHINGAR	NON AMR	OK	31.03.2023		Category 1				6740672	1200/577/1-1-1	13.678	NA	Director/D
B.2217	Central	CITY EAST LUDHIANA	11KV	D5 CMC (SPL) DIVN.	TECH. UNIT-II CMC (SPL)	D014FL01	HIRA NAGAR	AMR	OK	31.03.2023		Category 2				2046482	1200/577/1-1-1	14.509	NA	Director/D
B.2218	Central	CITY EAST LUDHIANA	11KV	D5 CMC (SPL) DIVN.	TECH. UNIT-II CMC (SPL)	D014FL20	11 KV MAYA PURI	NON AMR	OK	31.03.2023		Category 1				12092498	1200/577/1-1-1	14.646	NA	Director/D
B.2219	Central	CITY EAST LUDHIANA	11KV	D5 CMC (SPL) DIVN.	TECH. UNIT-II CMC (SPL)	D014FL05	TALJUR ROAD	NON AMR	OK	31.03.2023		Category 1				2066959	1200/577/1-1-1	14.754	NA	Director/D
B.2220	Central	CITY EAST LUDHIANA	11KV	D5 CMC (SPL) DIVN.	TECH. UNIT-II CMC (SPL)	D014FL03	HARGOBIND NAGAR	NON AMR	OK	31.03.2023		Category 1				2067685	1200/577/1-1-1	15.009	NA	Director/D
B.2221	Central	CITY EAST LUDHIANA	11KV	D5 CMC (SPL) DIVN.	TECH. UNIT-II CMC (SPL)	D014FL11	GAJAJ IAIN COLONY	AMR	OK	31.03.2023		Category 2				2065805	1200/577/1-1-1	16.262	NA	Director/D
B.2222	Central	CITY EAST LUDHIANA	11KV	D5 F. POINT (SPL) DIVN.	TECH. -F. POINT (SPL)	8007FL09	SUPREME AGRO FOOD UNIT-2	NON AMR	OK	31.03.2023		Category 4				1209337	1200/577/1-1-1	0.008	NA	Director/D
B.2223	Central	CITY EAST LUDHIANA	11KV	D5 F. POINT (SPL) DIVN.	TECH. -F. POINT (SPL)	8007FL13	NEW ASHOKA	NON AMR	OK	31.03.2023		Category 4				30266	1200/577/1-1-1	1.053	NA	Director/D
B.2224	Central	CITY EAST LUDHIANA	11KV	D5 F. POINT (SPL) DIVN.	TECH. -F. POINT (SPL)	8007FL02	ASHOKA	AMR	OK	31.03.2023		Category 2				11116765	1200/577/1-1-1	1.066	NA	Director/D
B.2225	Central	CITY EAST LUDHIANA	11KV	D5 F. POINT (SPL) DIVN.	TECH. -F. POINT (SPL)	8007FL17	ARK ENGG.	NON AMR	OK	31.03.2023		Category 2				16199288	1200/577/1-1-1	1.649	NA	Director/D
B.2226	Central	CITY EAST LUDHIANA	11KV	D5 F. POINT (SPL) DIVN.	TECH. -F. POINT (SPL)	8007FL15	KUMAR AUTO	NON AMR	OK	31.03.2023		Category 2				1024763	1200/577/1-1-1	2.391	NA	Director/D
B.2227	Central	CITY EAST LUDHIANA	11KV	D5 F. POINT (SPL) DIVN.	TECH. -F. POINT (SPL)	8007FL10	DEWAMTE	NON AMR	OK	31.03.2023		Category 4				7338802	1200/577/1-1-1	3.183	NA	Director/D
B.2228	Central	CITY EAST LUDHIANA	11KV	D5 F. POINT (SPL) DIVN.	TECH. -F. POINT (SPL)	8007FL08	METRO AZAD	AMR	OK	31.03.2023		Category 4				7042966	1200/577/1-1-1	3.226	NA	Director/D
B.2229	Central	CITY EAST LUDHIANA	11KV	D5 F. POINT (SPL) DIVN.	TECH. -F. POINT (SPL)	8007FL14	FARMPARTS	NON AMR	OK	31.03.2023		Category 2				35263	1200/577/1-1-1	3.489	NA	Director/D
B.2230	Central	CITY EAST LUDHIANA	11KV	D5 F. POINT (SPL) DIVN.	TECH. -F. POINT (SPL)	8007FL04	SUPREME AGRO FOODS UNIT-1	NON AMR	OK	31.03.2023		Category 4				7336848	1200/577/1-1-1	6.509	NA	Director/D
B.2231	Central	CITY EAST LUDHIANA	11KV	D5 F. POINT (SPL) DIVN.	TECH. -F. POINT (SPL)	8007FL09	SHIVALU	AMR	OK	31.03.2023		Category 2				961010229	1200/577/1-1-1	6.850	NA	Director/D
B.2232	Central	CITY EAST LUDHIANA	11KV	D5 F. POINT (SPL) DIVN.	TECH. -F. POINT (SPL)	8007FL12	GANESH AGRO YARN	AMR	OK	31.03.2023		Category 2				1027212	1200/577/1-1-1	8.094	NA	Director/D
B.2233	Central	CITY EAST LUDHIANA	11KV	D5 F. POINT (SPL) DIVN.	TECH. -F. POINT (SPL)	8007FL16	SPACE FASHION	NON AMR	OK	31.03.2023		Category 2				16199236	1200/577/1-1-1	9.279	NA	Director/D
B.2234	Central	CITY EAST LUDHIANA	11KV	D5 F. POINT (SPL) DIVN.	TECH. -F. POINT (SPL)	8007FL06	KING EXPORTS	NON AMR	OK	31.03.2023		Category 2				1027212	1200/577/1-1-1	10.198	NA	Director/D
B.2235	Central	CITY EAST LUDHIANA	11KV	D5 F. POINT (SPL) DIVN.	TECH. -F. POINT (SPL)	8007FL07	R&O CENTRE	AMR	OK	31.03.2023		Category 2				961010227	1200/577/1-1-1	12.806	NA	Director/D
B.2236	Central	CITY EAST LUDHIANA	11KV	D5 F. POINT (SPL) DIVN.	TECH. -F. POINT (SPL)	8007FL15	ARORA DYEING	AMR	OK	31.03.2023		Category 2				15199032	1200/577/1-1-1	13.908	NA	Director/D
B.2237	Central	CITY EAST LUDHIANA	11KV	D5 F. POINT (SPL) DIVN.	TECH. -F. POINT (SPL)	8007FL05	A.P.S	NON AMR	OK	31.03.2023		Category 2				1027596	1200/577/1-1-1	14.963	NA	Director/D
B.2238	Central	CITY EAST LUDHIANA	11KV	D5 F. POINT (SPL) DIVN.	TECH. -F. POINT (SPL)	8007FL01	GREATWAY	NON AMR	OK	31.03.2023		Category 2				961010226	1200/577/1-1-1	17.268	NA	Director/D
B.2239	Central	CITY EAST LUDHIANA	11KV	D5 F. POINT (SPL) DIVN.	TECH. -F. POINT (SPL)	D009FL04	NORTH INDIA	NON AMR	OK	31.03.2023		Category 4				166	1200/577/1-1-1	0.105	NA	Director/D
B.2240	Central	CITY EAST LUDHIANA	11KV	D5 F. POINT (SPL) DIVN.	TECH. -F. POINT (SPL)	D009FL03	MONGA	NON AMR	OK	31.03.2023		Category 2				2067491	1200/577/1-1-1	5.838	NA	Director/D
B.2241	Central	CITY EAST LUDHIANA	11KV	D5 F. POINT (SPL) DIVN.	TECH. -F. POINT (SPL)	D009FL02	INDUSTRIAL SHED	NON AMR	OK	31.03.2023		Category 2				2067576	1200/577/1-1-1	8.133	NA	Director/D
B.2242	Central	CITY EAST LUDHIANA	11KV	D5 F. POINT (SPL) DIVN.	TECH. -F. POINT (SPL)	D009FL05	NICKS INDIA	NON AMR	OK	31.03.2023		Category 2				187	1200/577/1-1-1	9.086	NA	Director/D
B.2243	Central	CITY EAST LUDHIANA	11KV	D5 F. POINT (SPL) DIVN.	TECH. -F. POINT (SPL)	D009FL01	BHANA	AMR	OK	31.03.2023		Category 2				2067407	1200/577/1-1-1	11.579	NA	Director/D
B.2244	Central	CITY EAST LUDHIANA	11KV	D5 F. POINT (SPL) DIVN.	TECH. -F. POINT (SPL)	D014FL19	SACRE HEART	AMR	OK	31.03.2023		Category 1				1027233	900/450/577/1-1-1	5.323	NA	Director/D
B.2245	Central	CITY EAST LUDHIANA	11KV	D5 F. POINT (SPL) DIVN.	TECH. -F. POINT (SPL)	D014FL21	DR. NOHRIVA	AMR	OK	31.03.2023		Category 1				583757	1200/577/1-1-1	5.840	NA	Director/D
B.2246	Central	CITY EAST LUDHIANA	11KV	D5 F. POINT (SPL) DIVN.	TECH. -F. POINT (SPL)	D014FL05	SEC-40	AMR	OK	31.03.2023		Category 1				9534569	900/450/577/1-1-1	9.890	NA	Director/D
B.2247	Central	CITY EAST LUDHIANA	11KV	D5 F. POINT (SPL) DIVN.	TECH. -F. POINT (SPL)	D014FL04	KUNDAN TV	AMR	OK	31.03.2023		Category 2				2065863	1200/577/1-1-1	11.277	NA	Director/D
B.2248	Central	CITY EAST LUDHIANA	11KV	D5 F. POINT (SPL) DIVN.	TECH. -F. POINT (SPL)	D014FL16	H.101	AMR	OK	31.03.2023		Category 1				2067387	1200/577/1-1-1	11.313	NA	Director/D
B.2249	Central	CITY EAST LUDHIANA	11KV	D5 F. POINT (SPL) DIVN.	TECH. -F. POINT (SPL)	D014FL08	Tashar Feeder	AMR	OK	31.03.2023		Category 2				583755	900/450/577/1-1-1	12.581	NA	Director/D
B.2250	Central	CITY EAST LUDHIANA	11KV	D5 F. POINT (SPL) DIVN.	TECH. -F. POINT (SPL)	D014FL01	BEANTPURA	NON AMR	OK	31.03.2023		Category 1				7336506	1200/577/1-1-1	13.197	NA	Director/D
B.2251	Central	CITY EAST LUDHIANA	11KV	D5 F. POINT (SPL) DIVN.	TECH. -F. POINT (SPL)	D008F	EMSON TOOLS	NON AMR	OK	31.03.2023		Category 2				7036405	1200/577/1-1-1	0.031	NA	Director/D
B.2252	Central	CITY EAST LUDHIANA	11KV	D5 F. POINT (SPL) DIVN.	TECH. -F. POINT (SPL)	D008FL13	HERO MAJESTIC	NON AMR	OK	31.03.2023		Category 2				1679	1200/577/1-1-1	0.586	NA	Director/D
B.2253	Central	CITY EAST LUDHIANA	11KV	D5 F. POINT (SPL) DIVN.	TECH. -F. POINT (SPL)	D008FL	MARKFED	AMR	OK	31.03.2023		Category 2				9141034	1200/577/1-1-1	1.270	NA	Director/D
B.2254	Central	CITY EAST LUDHIANA	11KV	D5 F. POINT (SPL) DIVN.	TECH. -F. POINT (SPL)	D008FL23	SAH ENGG.	NON AMR	OK	31.03.2023		Category 2				1027596	1200/577/1-1-1	2.845	NA	Director/D
B.2255	Central	CITY EAST LUDHIANA	11KV	D5 F. POINT (SPL) DIVN.	TECH. -F. POINT (SPL)	D008FL10	Sudbhah woolen milks	NON AMR	OK	31.03.2023		Category 4				8223469	1200/577/1-1-1	4.303	NA	Director/D
B.2256	Central	CITY EAST LUDHIANA	11KV	D5 F. POINT (SPL) DIVN.	TECH. -F. POINT (SPL)	D008FL11	METRO	NON AMR	OK	31.03.2023		Category 2				1684	1200/577/1-1-1	4.374	NA	Director/D
B.2257	Central	CITY EAST LUDHIANA	11KV	D5 F. POINT (SPL) DIVN.	TECH. -F. POINT (SPL)	D008FL06	UNITED BREWERIES	NON AMR	OK	31.03.2023		Category 3				1693	1200/577/1-1-1	4.657	NA	Director/D
B.2258	Central	CITY EAST LUDHIANA	11KV	D5 F. POINT (SPL) DIVN.	TECH. -F. POINT (SPL)	D008FL15	KANGROD	AMR	OK	31.03.2023		Category 4				1692	1200/577/1-1-1	4.725	NA	Director/D
B.2259	Central	CITY EAST LUDHIANA	11KV	D5 F. POINT (SPL) DIVN.	TECH. -F. POINT (SPL)	D008FL21	RAJESH	NON AMR	OK	31.03.2023		Category 2				1017921	1200/577/1-1-1	7.856	NA	Director/D
B.2260	Central	CITY EAST LUDHIANA	11KV	D5 F. POINT (SPL) DIVN.	TECH. -F. POINT (SPL)	D008FL02	FOCAL POINT	NON AMR	OK	31.03.2023		Category 2				8222637	1200/577/1-1-1	8.468	NA	Director/D
B.2261	Central	CITY EAST LUDHIANA	11KV	D5 F. POINT (SPL) DIVN.	TECH. -F. POINT (SPL)	D008FL05	AARTI STEEL	AMR	OK	31.03.2023		Category 2								

S.No	Zone	Circle	Voltage Level (kVA)	Division (kVA)	Sub-Division (kVA)	Feeder ID	Feeder Name	Feeder Metering Status (Metred/unmetred/AMR/AMI)	Status of Meter (Functional/Non-functional)	Metering Date (Date of last actual meter reading)/communication	Feeder Type (Agr./Industrial/Mixed)	Status of Communication		Period from 01.04.2021 to 31.03.2022				Sales	Remarks (Source of data)
												% data received through automatically if feeder AMR/AMI	Number of hours when meter was unable to communicate in overall	Total Number of hours in the period	Meter S.No	CT/PT ratio	Import (MU)		
B.2298	Central	CITY EAST LUDHIANA	66KV	DS F. POINT (SPL) DIVN.	TECH.-I F. POINT (SPL)	8002FL08	VARDHMAN SPECIAL STEEL	AMR	OK	31.03.2023	Category 3			Not available	Not available	178.081	NA	Director/D	
B.2299	Central	CITY EAST LUDHIANA	11KV	DS F. POINT (SPL) DIVN.	TECH.-II F. POINT (SPL)	8001FL16	MUNIAL GAS	AMR	OK	31.03.2023	Category 4			8223170	1200/577/1-1-1	0.050	NA	Director/D	
B.2300	Central	CITY EAST LUDHIANA	11KV	DS F. POINT (SPL) DIVN.	TECH.-II F. POINT (SPL)	8001FL18	MUNDIAN	AMR	OK	31.03.2023	AP 3Phase 3Wire			8222346	1200/577/1-1-1	1.953	NA	Director/D	
B.2301	Central	CITY EAST LUDHIANA	11KV	DS F. POINT (SPL) DIVN.	TECH.-II F. POINT (SPL)	8001FL08	CHANDGARH ROAD	AMR	OK	31.03.2023	Category 1			1106089	1200/577/1-1-1	3.160	NA	Director/D	
B.2302	Central	CITY EAST LUDHIANA	11KV	DS F. POINT (SPL) DIVN.	TECH.-II F. POINT (SPL)	8001FL09	G.S.	AMR	OK	31.03.2023	Category 2			6607725	1200/577/1-1-1	3.866	NA	Director/D	
B.2303	Central	CITY EAST LUDHIANA	11KV	DS F. POINT (SPL) DIVN.	TECH.-II F. POINT (SPL)	8001FL13	KHURANA STEEL	AMR	OK	31.03.2023	Category 2			8222883	1200/577/1-1-1	6.092	NA	Director/D	
B.2304	Central	CITY EAST LUDHIANA	11KV	DS F. POINT (SPL) DIVN.	TECH.-II F. POINT (SPL)	8001FL04	O.P.T STEEL	AMR	OK	31.03.2023	Category 2			5342512	1200/577/1-1-1	6.584	NA	Director/D	
B.2305	Central	CITY EAST LUDHIANA	11KV	DS F. POINT (SPL) DIVN.	TECH.-II F. POINT (SPL)	8001FL07	HOSEYI COMPLEX	AMR	OK	31.03.2023	Category 2			2047170	1200/577/1-1-1	6.670	NA	Director/D	
B.2306	Central	CITY EAST LUDHIANA	11KV	DS F. POINT (SPL) DIVN.	TECH.-II F. POINT (SPL)	8001FL19	METRO TYRE	AMR	OK	31.03.2023	Category 1			2067100	1200/577/1-1-1	6.708	NA	Director/D	
B.2307	Central	CITY EAST LUDHIANA	11KV	DS F. POINT (SPL) DIVN.	TECH.-II F. POINT (SPL)	8001FL17	SAVIDHA	AMR	OK	31.03.2023	Category 2			1106952	1200/577/1-1-1	8.363	NA	Director/D	
B.2308	Central	CITY EAST LUDHIANA	11KV	DS F. POINT (SPL) DIVN.	TECH.-II F. POINT (SPL)	8001FL02	SAHIBANA	AMR	OK	31.03.2023	Category 5-UPS			8223526	1200/577/1-1-1	9.338	NA	Director/D	
B.2309	Central	CITY EAST LUDHIANA	11KV	DS F. POINT (SPL) DIVN.	TECH.-II F. POINT (SPL)	8001FL06	THAPER ISPAT	AMR	OK	31.03.2023	Category 2			6675546	1200/577/1-1-1	10.635	NA	Director/D	
B.2310	Central	CITY EAST LUDHIANA	11KV	DS F. POINT (SPL) DIVN.	TECH.-II F. POINT (SPL)	8001FL03	J.S TOOL	AMR	OK	31.03.2023	Category 2			8222990	1200/577/1-1-1	10.924	NA	Director/D	
B.2311	Central	CITY EAST LUDHIANA	11KV	DS F. POINT (SPL) DIVN.	TECH.-II F. POINT (SPL)	8001FL14	OLD SARYANS	AMR	OK	31.03.2023	Category 2			8223497	1200/577/1-1-1	11.199	NA	Director/D	
B.2312	Central	CITY EAST LUDHIANA	11KV	DS F. POINT (SPL) DIVN.	TECH.-II F. POINT (SPL)	8001FL20	NON AMR	OK	31.03.2023	Category 3			2065786	1200/577/1-1-1	17.446	NA	Director/D		
B.2313	Central	CITY EAST LUDHIANA	11KV	DS F. POINT (SPL) DIVN.	TECH.-II F. POINT (SPL)	8002FL02	INDUSTRIAL	NON AMR	OK	31.03.2023	Category 1			8222418	900-450/577/1-1-1	3.325	NA	Director/D	
B.2314	Central	CITY EAST LUDHIANA	11KV	DS F. POINT (SPL) DIVN.	TECH.-II F. POINT (SPL)	8002FL01	KAKKA	NON AMR	OK	31.03.2023	Category 1			8223499	900-450/577/1-1-1	12.635	NA	Director/D	
B.2315	Central	CITY EAST LUDHIANA	11KV	DS F. POINT (SPL) DIVN.	TECH.-II F. POINT (SPL)	0015FL11	MONGIA ISPAT	AMR	OK	31.03.2023	Category 2			7424135	1200/577/1-1-1	0.000	NA	Director/D	
B.2316	Central	CITY EAST LUDHIANA	11KV	DS F. POINT (SPL) DIVN.	TECH.-II F. POINT (SPL)	0015FL02	ADDINATH	NON AMR	OK	31.03.2023	Category 2			1234	1200/577/1-1-1	0.133	NA	Director/D	
B.2317	Central	CITY EAST LUDHIANA	11KV	DS F. POINT (SPL) DIVN.	TECH.-II F. POINT (SPL)	0015FL10	SRIVANSH	AMR	OK	31.03.2023	Category 2			5264769	1200/577/1-1-1	0.563	NA	Director/D	
B.2318	Central	CITY EAST LUDHIANA	11KV	DS F. POINT (SPL) DIVN.	TECH.-II F. POINT (SPL)	0015FL26	Lal Export	AMR	OK	31.03.2023	Category 2			7424100	1200/577/1-1-1	0.960	NA	Director/D	
B.2319	Central	CITY EAST LUDHIANA	11KV	DS F. POINT (SPL) DIVN.	TECH.-II F. POINT (SPL)	0015FL04	MUKESH STEEL	NON AMR	OK	31.03.2023	Category 3			5264305	1200/577/1-1-1	1.075	NA	Director/D	
B.2320	Central	CITY EAST LUDHIANA	11KV	DS F. POINT (SPL) DIVN.	TECH.-II F. POINT (SPL)	0015FL32	11KV Ishwar Industries	AMR	OK	31.03.2023	Category 4			3932	1200/577/1-1-1	1.084	NA	Director/D	
B.2321	Central	CITY EAST LUDHIANA	11KV	DS F. POINT (SPL) DIVN.	TECH.-II F. POINT (SPL)	0015FL23	Amco Gold Star	AMR	OK	31.03.2023	Category 2			12092486	1200-600/5	2.022	NA	Director/D	
B.2322	Central	CITY EAST LUDHIANA	11KV	DS F. POINT (SPL) DIVN.	TECH.-II F. POINT (SPL)	0015FL27	EXCELLENT FORG FEEDER	NON AMR	OK	31.03.2023	Category 2			6740794	1200/577/1-1-1	3.962	NA	Director/D	
B.2323	Central	CITY EAST LUDHIANA	11KV	DS F. POINT (SPL) DIVN.	TECH.-II F. POINT (SPL)	0015FL18	NEW SURINDRA CYCLE	AMR	OK	31.03.2023	Category 2			10282777	1200/577/1-1-1	4.464	NA	Director/D	
B.2324	Central	CITY EAST LUDHIANA	11KV	DS F. POINT (SPL) DIVN.	TECH.-II F. POINT (SPL)	0015FL35	Ashish International	NON AMR	OK	31.03.2023	Category 2			5474	1200/577/1-1-1	4.693	NA	Director/D	
B.2325	Central	CITY EAST LUDHIANA	11KV	DS F. POINT (SPL) DIVN.	TECH.-II F. POINT (SPL)	0015FL16	CENTER INTERNATIONAL	AMR	OK	31.03.2023	Category 2			11069762	1200/577/1-1-1	5.229	NA	Director/D	
B.2326	Central	CITY EAST LUDHIANA	11KV	DS F. POINT (SPL) DIVN.	TECH.-II F. POINT (SPL)	0015FL25	ESSEN FORGING	NON AMR	OK	31.03.2023	Category 2			12093478	1200-600/5	5.349	NA	Director/D	
B.2327	Central	CITY EAST LUDHIANA	11KV	DS F. POINT (SPL) DIVN.	TECH.-II F. POINT (SPL)	0015FL17	SUDARSHAN CONCAST	AMR	OK	31.03.2023	Category 2			10281205	1200/577/1-1-1	5.496	NA	Director/D	
B.2328	Central	CITY EAST LUDHIANA	11KV	DS F. POINT (SPL) DIVN.	TECH.-II F. POINT (SPL)	0015FL23	Agri Forging	AMR	OK	31.03.2023	Category 4			4674	1200/577/1-1-1	5.570	NA	Director/D	
B.2329	Central	CITY EAST LUDHIANA	11KV	DS F. POINT (SPL) DIVN.	TECH.-II F. POINT (SPL)	0015FL34	Ranjani Machine	AMR	OK	31.03.2023	Category 2			202650	1200/577/1-1-1	6.305	NA	Director/D	
B.2330	Central	CITY EAST LUDHIANA	11KV	DS F. POINT (SPL) DIVN.	TECH.-II F. POINT (SPL)	0015FL20	K.K. Rubber	NON AMR	OK	31.03.2023	Category 2			12092452	1200/577/1-1-1	6.354	NA	Director/D	
B.2331	Central	CITY EAST LUDHIANA	11KV	DS F. POINT (SPL) DIVN.	TECH.-II F. POINT (SPL)	0015FL03	SHARU STEEL	AMR	OK	31.03.2023	Category 2			209	1200/577/1-1-1	6.640	NA	Director/D	
B.2332	Central	CITY EAST LUDHIANA	11KV	DS F. POINT (SPL) DIVN.	TECH.-II F. POINT (SPL)	0015FL30	BUSINESS PARK	AMR	OK	31.03.2023	Category 3			126566	1200/577/1-1-1	7.486	NA	Director/D	
B.2333	Central	CITY EAST LUDHIANA	11KV	DS F. POINT (SPL) DIVN.	TECH.-II F. POINT (SPL)	0015FL01	D.C. STEEL	AMR	OK	31.03.2023	Category 3			7424100	1200-600/5	9.242	NA	Director/D	
B.2334	Central	CITY EAST LUDHIANA	11KV	DS F. POINT (SPL) DIVN.	TECH.-II F. POINT (SPL)	0015FL22	VIBRANT COMPONENT	NON AMR	OK	31.03.2023	Category 2			12092455	1200-600/5	10.360	NA	Director/D	
B.2335	Central	CITY EAST LUDHIANA	11KV	DS F. POINT (SPL) DIVN.	TECH.-II F. POINT (SPL)	0015FL05	B.P.3 FORGERS	AMR	OK	31.03.2023	Category 2			6742698	1200/577/1-1-1	10.887	NA	Director/D	
B.2336	Central	CITY EAST LUDHIANA	11KV	DS F. POINT (SPL) DIVN.	TECH.-II F. POINT (SPL)	0015FL31	J.V.M.	NON AMR	OK	31.03.2023	Category 2			16199355	1200-600/5	10.955	NA	Director/D	
B.2337	Central	CITY EAST LUDHIANA	11KV	DS F. POINT (SPL) DIVN.	TECH.-II F. POINT (SPL)	0015FL24	IYOTI	NON AMR	OK	31.03.2023	Category 2			5264332	1200/577/1-1-1	11.851	NA	Director/D	
B.2338	Central	CITY EAST LUDHIANA	11KV	DS F. POINT (SPL) DIVN.	TECH.-II F. POINT (SPL)	0015FL09	C.I. ENGG.	AMR	OK	31.03.2023	Category 3			4262743	1200/577/1-1-1	11.909	NA	Director/D	
B.2339	Central	CITY EAST LUDHIANA	11KV	DS F. POINT (SPL) DIVN.	TECH.-II F. POINT (SPL)	0015FL29	BHOLA PUR	NON AMR	OK	31.03.2023	Category 1			33752	1200/577/1-1-1	12.072	NA	Director/D	
B.2340	Central	CITY EAST LUDHIANA	11KV	DS F. POINT (SPL) DIVN.	TECH.-II F. POINT (SPL)	0015FL12	PERFECT DYENING	AMR	OK	31.03.2023	Category 2			199	1200/577/1-1-1	13.185	NA	Director/D	
B.2341	Central	CITY EAST LUDHIANA	11KV	DS F. POINT (SPL) DIVN.	TECH.-II F. POINT (SPL)	0015FL08	SURINDRA CYCLE	NON AMR	OK	31.03.2023	Category 2			192	1200-600/5	12.983	NA	Director/D	
B.2342	Central	CITY EAST LUDHIANA	11KV	DS F. POINT (SPL) DIVN.	TECH.-II F. POINT (SPL)	0015FL13	HERO CYCLE	NON AMR	OK	31.03.2023	Category 2			193	1200/577/1-1-1	13.286	NA	Director/D	
B.2343	Central	CITY EAST LUDHIANA	11KV	DS F. POINT (SPL) DIVN.	TECH.-II F. POINT (SPL)	0015FL07	R.K. CONCAST	AMR	OK	31.03.2023	Category 2			6740691	1200/577/1-1-1	14.645	NA	Director/D	
B.2344	Central	CITY EAST LUDHIANA	11KV	DS F. POINT (SPL) DIVN.	TECH.-II F. POINT (SPL)	0015FL28	SHARU SPECIAL ALLOY	NON AMR	OK	31.03.2023	Category 2			8223788	1200/577/1-1-1	14.959	NA	Director/D	
B.2345	Central	CITY EAST LUDHIANA	11KV	DS F. POINT (SPL) DIVN.	TECH.-II F. POINT (SPL)	0015FL15	NARODY ALLOYS	AMR	OK	31.03.2023	Category 3			12092456	1200/577/1-1-1	15.360	NA	Director/D	
B.2346	Central	CITY EAST LUDHIANA	11KV	DS F. POINT (SPL) DIVN.	TECH.-II F. POINT (SPL)	0015FL21	SAINI PREFESSION	AMR	OK	31.03.2023	Category 3			12092408	1200-600/5	16.002	NA	Director/D	
B.2347	Central	CITY EAST LUDHIANA	11KV	DS F. POINT (SPL) DIVN.	TECH.-II F. POINT (SPL)	0024FL08	SUPREME YARNS	NON AMR	OK	31.03.2023	Category 4			2067701	1200/577/1-1-1	0.000	NA	Director/D	
B.2348	Central	CITY EAST LUDHIANA	11KV	DS F. POINT (SPL) DIVN.	TECH.-II F. POINT (SPL)	0024FL09	PUNJIA KESRI	AMR	OK	31.03.2023	Category 4			9140883	1200/577/1-1-1	0.261	NA	Director/D	
B.2349	Central	CITY EAST LUDHIANA	11KV	DS F. POINT (SPL) DIVN.	TECH.-II F. POINT (SPL)	0024FL22	B.H. Engg	AMR	OK	31.03.2023	Category 4			18625	1200/577/1-1-1	0.457	NA	Director/D	
B.2350	Central	CITY EAST LUDHIANA	11KV	DS F. POINT (SPL) DIVN.	TECH.-II F. POINT (SPL)	0024FL23	Mega Line	AMR	OK	31.03.2023	Category 4			12540	1200/577/1-1-1	1.035	NA	Director/D	
B.2351	Central	CITY EAST LUDHIANA	11KV	DS F. POINT (SPL) DIVN.	TECH.-II F. POINT (SPL)	0024FL18	PERFECT DYENING	AMR	OK	31.03.2023	Category 2			7313337	1200/577/1-1-1	1.105	NA	Director/D	
B.2352	Central	CITY EAST LUDHIANA	11KV	DS F. POINT (SPL) DIVN.	TECH.-II F. POINT (SPL)	0024FL25	Shiv Shakti (Ck-2)	AMR	OK	31.03.2023	Category 2			11154	1200/577/1-1-1	1.145	NA	Director/D	
B.2353	Central	CITY EAST LUDHIANA	11KV	DS F. POINT (SPL) DIVN.	TECH.-II F. POINT (SPL)	0024FL12	FORTIS HOSPITAL	AMR	OK	31.03.2023	Category 4			12479344	1200/577/1-1-1	1.313	NA	Director/D	
B.2354	Central	CITY EAST LUDHIANA	11KV	DS F. POINT (SPL) DIVN.	TECH.-II F. POINT (SPL)	0024FL19	11KV Ruby Dying	AMR	OK	31.03.2023	Category 1			3956	1200/577/1-1-1	1.489	NA	Director/D	
B.2355	Central	CITY EAST LUDHIANA	11KV																

S.No	Zone	Circle	Voltage Level (kVA)	Division (kVA)	Sub-Division (kVA)	Feeder ID	Feeder Name	Feeder Metering Status (Metred/unmetred/ AMI/AMI)	Status of Meter (Functional/Non-Functional)	Metering Date (Date of last actual meter reading/ communication)	Feeder Type (Agr/ Industrial/Mixed)	Status of Communication		Period from 01.04.2021 to 31.03.2022				Sales	Remarks (Source of data)
												% data received through automatically if feeder AMR/AMI	Number of hours when meter was unable to communicate in overall	Total Number of hours in the period	Meter S.No	CT/PT ratio	Import (kU)		
B.2395	Central	CITY EAST LUDHIANA	11KV	DS F. POINT (SPL) DIVN	TECH.-III F. POINT (SPL)	D016FL17	BALA JJ	AMR	OK	31.03.2023	Category 2			33761	900-450/577/1-1	23.688	NA	Director/D	
B.2396	Central	CITY EAST LUDHIANA	11KV	DS F. POINT (SPL) DIVN	TECH.-III F. POINT (SPL)	D031FL10	ISHAN	AMR	OK	31.03.2023	Category 2			33675	1200/577/1-1	1.643	NA	Director/D	
B.2397	Central	CITY EAST LUDHIANA	11KV	DS F. POINT (SPL) DIVN	TECH.-III F. POINT (SPL)	D031FL17	SEWAGE TREATMENT PLANT	NON AMR	OK	31.03.2023	Category 2			1546	1200/577/1-1	1.865	NA	Director/D	
B.2398	Central	CITY EAST LUDHIANA	11KV	DS F. POINT (SPL) DIVN	TECH.-III F. POINT (SPL)	D031FL06	KENDRI JAI	AMR	OK	31.03.2023	Category 4			2357	1200/577/1-1	1.978	NA	Director/D	
B.2399	Central	CITY EAST LUDHIANA	11KV	DS F. POINT (SPL) DIVN	TECH.-III F. POINT (SPL)	D031FL18	Jawand Sons	AMR	OK	31.03.2023	Category 4			2695	1200/577/1-1	1.996	NA	Director/D	
B.2400	Central	CITY EAST LUDHIANA	11KV	DS F. POINT (SPL) DIVN	TECH.-III F. POINT (SPL)	D031FL19	B R Knifab	AMR	OK	31.03.2023	Category 2			65154	1200/577/1-1	5.552	NA	Director/D	
B.2401	Central	CITY EAST LUDHIANA	11KV	DS F. POINT (SPL) DIVN	TECH.-III F. POINT (SPL)	D031FL06	JAI GANESH	AMR	OK	31.03.2023	Category 1			2066694	1200/577/1-1	6.013	NA	Director/D	
B.2402	Central	CITY EAST LUDHIANA	11KV	DS F. POINT (SPL) DIVN	TECH.-III F. POINT (SPL)	D031FL20	Tajpur	AMR	OK	31.03.2023	Category 1			34132	1200/577/1-1	8.833	NA	Director/D	
B.2403	Central	CITY EAST LUDHIANA	11KV	DS F. POINT (SPL) DIVN	TECH.-III F. POINT (SPL)	D031FL09	SUNDRI	AMR	OK	31.03.2023	Category 2			34015	1200/577/1-1	10.748	NA	Director/D	
B.2404	Central	CITY EAST LUDHIANA	11KV	DS F. POINT (SPL) DIVN	TECH.-III F. POINT (SPL)	D031FL16	LOVELY DYEING	AMR	OK	31.03.2023	Category 2			33706	1200/577/1-1	11.818	NA	Director/D	
B.2405	Central	CITY EAST LUDHIANA	11KV	DS F. POINT (SPL) DIVN	TECH.-III F. POINT (SPL)	D031FL12	GTB Nagar	AMR	OK	31.03.2023	Category 2			15192315	1200/577/1-1	12.417	NA	Director/D	
B.2406	Central	CITY EAST LUDHIANA	11KV	DS F. POINT (SPL) DIVN	TECH.-III F. POINT (SPL)	D031FL05	BHAMANI	AMR	OK	31.03.2023	Category 1			155655	1200/577/1-1	13.435	NA	Director/D	
B.2407	Central	CITY EAST LUDHIANA	11KV	DS F. POINT (SPL) DIVN	TECH.-III F. POINT (SPL)	D031FL15	YOGI DYEING	AMR	OK	31.03.2023	Category 2			1594	1200/577/1-1	14.407	NA	Director/D	
B.2408	Central	CITY EAST LUDHIANA	11KV	DS F. POINT (SPL) DIVN	TECH.-III F. POINT (SPL)	D031FL11	Baba Ji Processor	AMR	OK	31.03.2023	Category 2			6550	1200/577/1-1	15.165	NA	Director/D	
B.2409	Central	CITY EAST LUDHIANA	11KV	DS F. POINT (SPL) DIVN	TECH.-III F. POINT (SPL)	D031FL01	GURU NANAK NAGAR	AMR	OK	31.03.2023	Category 1			24467	1200/577/1-1	15.516	NA	Director/D	
B.2410	Central	CITY EAST LUDHIANA	11KV	DS F. POINT (SPL) DIVN	TECH.-III F. POINT (SPL)	D031FL13	GETTA COLONY	AMR	OK	31.03.2023	Category 1			15196167	1200/577/1-1	15.519	NA	Director/D	
B.2411	Central	CITY EAST LUDHIANA	11KV	DS F. POINT (SPL) DIVN	TECH.-III F. POINT (SPL)	D031FL07	STAR CITY	AMR	OK	31.03.2023	Category 1			2541	1200/577/1-1	16.416	NA	Director/D	
B.2412	Central	CITY EAST LUDHIANA	11KV	DS F. POINT (SPL) DIVN	TECH.-III F. POINT (SPL)	D031FL08	COMPANY BAGH	NON AMR	OK	31.03.2023	Category 1			33675	1200/577/1-1	18.019	NA	Director/D	
B.2413	Central	CITY EAST LUDHIANA	11KV	DS F. POINT (SPL) DIVN	TECH.-III F. POINT (SPL)	D031FL02	JASWAL COMPLEX	AMR	OK	31.03.2023	Category 2			23176	1200/577/1-1	19.102	NA	Director/D	
B.2414	Central	CITY EAST LUDHIANA	11KV	DS F. POINT (SPL) DIVN	TECH.-III F. POINT (SPL)	D031FL14	CU PROCESSOR	NON AMR	OK	31.03.2023	Category 2			33706	1200/577/1-1	20.277	NA	Director/D	
B.2415	Central	CITY EAST LUDHIANA	11KV	DS F. POINT (SPL) DIVN	TECH.-III F. POINT (SPL)	D031FL03	KOHLI	NON AMR	OK	31.03.2023	Category 1			23216	1200/577/1-1	20.214	NA	Director/D	
B.2416	Central	CITY EAST LUDHIANA	11KV	DS S. NAGAR (SPL) DIVN	TECH.-I S. NAGAR (SPL)	D004FL05	KAKWAL	AMR	OK	31.03.2023	AP 3Phase 3Wire			11116824	Not installed	0.527	NA	Director/D	
B.2417	Central	CITY EAST LUDHIANA	11KV	DS S. NAGAR (SPL) DIVN	TECH.-I S. NAGAR (SPL)	D004FL15	BAHADURKEY	AMR	OK	31.03.2023	Category 5-U/PS			11069787	1200/577/1-1	6.063	NA	Director/D	
B.2418	Central	CITY EAST LUDHIANA	11KV	DS S. NAGAR (SPL) DIVN	TECH.-I S. NAGAR (SPL)	D004FL39	NAVKAAR	NON AMR	OK	31.03.2023	Category 1			33688	900-450/577/1-1	7.125	NA	Director/D	
B.2419	Central	CITY EAST LUDHIANA	11KV	DS S. NAGAR (SPL) DIVN	TECH.-I S. NAGAR (SPL)	D004FL11	NEW MADHOPURI	NON AMR	OK	31.03.2023	Category 1			9154247	1200/577/1-1	7.413	NA	Director/D	
B.2420	Central	CITY EAST LUDHIANA	11KV	DS S. NAGAR (SPL) DIVN	TECH.-I S. NAGAR (SPL)	D004FL23	FARID NAGAR	AMR	OK	31.03.2023	Category 1			9154206	1200/577/1-1	7.408	NA	Director/D	
B.2421	Central	CITY EAST LUDHIANA	11KV	DS S. NAGAR (SPL) DIVN	TECH.-I S. NAGAR (SPL)	D004FL36	WESTON	NON AMR	OK	31.03.2023	Category 1			11117327	Not installed	8.429	NA	Director/D	
B.2422	Central	CITY EAST LUDHIANA	11KV	DS S. NAGAR (SPL) DIVN	TECH.-I S. NAGAR (SPL)	D004FL02	NEW SHIVPURI	NON AMR	OK	31.03.2023	Category 1			2068324	Not installed	8.920	NA	Director/D	
B.2423	Central	CITY EAST LUDHIANA	11KV	DS S. NAGAR (SPL) DIVN	TECH.-I S. NAGAR (SPL)	D004FL28	GURU NANAK DEV NGR	AMR	OK	31.03.2023	Category 1			6679853	1200/577/1-1	9.263	NA	Director/D	
B.2424	Central	CITY EAST LUDHIANA	11KV	DS S. NAGAR (SPL) DIVN	TECH.-I S. NAGAR (SPL)	D004FL22	DALAUT COLONY	AMR	OK	31.03.2023	Category 2			266547	1200/577/1-1	9.533	NA	Director/D	
B.2425	Central	CITY EAST LUDHIANA	11KV	DS S. NAGAR (SPL) DIVN	TECH.-I S. NAGAR (SPL)	D004FL42	ASHOHA	NON AMR	OK	31.03.2023	Category 1			9154247	1200/577/1-1	9.545	NA	Director/D	
B.2426	Central	CITY EAST LUDHIANA	11KV	DS S. NAGAR (SPL) DIVN	TECH.-I S. NAGAR (SPL)	D004FL19	GHATKY	AMR	OK	31.03.2023	Category 2			14653	1200/577/1-1	9.610	NA	Director/D	
B.2427	Central	CITY EAST LUDHIANA	11KV	DS S. NAGAR (SPL) DIVN	TECH.-I S. NAGAR (SPL)	D004FL40	70 FUTTA ROAD	NON AMR	OK	31.03.2023	Category 1			983756	900-450/577/1-1	9.706	NA	Director/D	
B.2428	Central	CITY EAST LUDHIANA	11KV	DS S. NAGAR (SPL) DIVN	TECH.-I S. NAGAR (SPL)	D004FL13	KIRPAL NAGAR	AMR	OK	31.03.2023	Category 1			6489714	1200/577/1-1	9.774	NA	Director/D	
B.2429	Central	CITY EAST LUDHIANA	11KV	DS S. NAGAR (SPL) DIVN	TECH.-I S. NAGAR (SPL)	D004FL01	SUNDER NAGAR	NON AMR	OK	31.03.2023	Category 2			9094438	Not installed	10.117	NA	Director/D	
B.2430	Central	CITY EAST LUDHIANA	11KV	DS S. NAGAR (SPL) DIVN	TECH.-I S. NAGAR (SPL)	D004FL14	BAL SINGH NAGAR	NON AMR	OK	31.03.2023	Category 1			2407167	1200/577/1-1	10.457	NA	Director/D	
B.2431	Central	CITY EAST LUDHIANA	11KV	DS S. NAGAR (SPL) DIVN	TECH.-I S. NAGAR (SPL)	D004FL35	FARID NAGAR	NON AMR	OK	31.03.2023	Category 2			2068324	1200/577/1-1	10.644	NA	Director/D	
B.2432	Central	CITY EAST LUDHIANA	11KV	DS S. NAGAR (SPL) DIVN	TECH.-I S. NAGAR (SPL)	D004FL49	Anmol	NON AMR	OK	31.03.2023	Category 2			39323	1200/577/1-1	11.462	NA	Director/D	
B.2433	Central	CITY EAST LUDHIANA	11KV	DS S. NAGAR (SPL) DIVN	TECH.-I S. NAGAR (SPL)	D004FL09	SEEHEVAL	NON AMR	OK	31.03.2023	Category 1			12093591	Not installed	11.892	NA	Director/D	
B.2434	Central	CITY EAST LUDHIANA	11KV	DS S. NAGAR (SPL) DIVN	TECH.-I S. NAGAR (SPL)	D004FL20	JAIN COLONY	AMR	OK	31.03.2023	Category 1			7336857	1200/577/1-1	12.131	NA	Director/D	
B.2435	Central	CITY EAST LUDHIANA	11KV	DS S. NAGAR (SPL) DIVN	TECH.-I S. NAGAR (SPL)	D004FL29	MASTER COLONY	AMR	OK	31.03.2023	Category 1			73130479	Not installed	12.644	NA	Director/D	
B.2436	Central	CITY EAST LUDHIANA	11KV	DS S. NAGAR (SPL) DIVN	TECH.-I S. NAGAR (SPL)	D004FL30	PRITAMPURI	AMR	OK	31.03.2023	Category 1			9094555	1200/577/1-1	13.338	NA	Director/D	
B.2437	Central	CITY EAST LUDHIANA	11KV	DS S. NAGAR (SPL) DIVN	TECH.-I S. NAGAR (SPL)	D004FL41	BASTI JODHEWAL	NON AMR	OK	31.03.2023	Category 1			9094424	1200/577/1-1	13.520	NA	Director/D	
B.2438	Central	CITY EAST LUDHIANA	11KV	DS S. NAGAR (SPL) DIVN	TECH.-I S. NAGAR (SPL)	D004FL16	NEW WISHNUPURI	AMR	OK	31.03.2023	Category 1			5388184	1200/577/1-1	13.940	NA	Director/D	
B.2439	Central	CITY EAST LUDHIANA	11KV	DS S. NAGAR (SPL) DIVN	TECH.-I S. NAGAR (SPL)	D004FL25	Jagat Nagar	NON AMR	OK	31.03.2023	Category 1			73131638	Not installed	14.809	NA	Director/D	
B.2440	Central	CITY EAST LUDHIANA	11KV	DS S. NAGAR (SPL) DIVN	TECH.-I S. NAGAR (SPL)	D004FL34	VISHAL COLONY	AMR	OK	31.03.2023	Category 1			9153575	Not installed	15.793	NA	Director/D	
B.2441	Central	CITY EAST LUDHIANA	11KV	DS S. NAGAR (SPL) DIVN	TECH.-I S. NAGAR (SPL)	D004FL33	DASHMESH PURI	NON AMR	OK	31.03.2023	Category 1			39721	1200/577/1-1	16.747	NA	Director/D	
B.2442	Central	CITY EAST LUDHIANA	11KV	DS S. NAGAR (SPL) DIVN	TECH.-I S. NAGAR (SPL)	D004FL04	NANDPURI	AMR	OK	31.03.2023	Category 1			10273720	1200/577/1-1	17.006	NA	Director/D	
B.2443	Central	CITY EAST LUDHIANA	11KV	DS S. NAGAR (SPL) DIVN	TECH.-I S. NAGAR (SPL)	D029FL07	WIBSON	AMR	OK	31.03.2023	Category 4			30222	1200/577/1-1	2.182	NA	Director/D	
B.2444	Central	CITY EAST LUDHIANA	11KV	DS S. NAGAR (SPL) DIVN	TECH.-I S. NAGAR (SPL)	D029FL15	RISHAB COTSPIN	AMR	OK	31.03.2023	Category 4			16199437	1200/577/1-1	2.520	NA	Director/D	
B.2445	Central	CITY EAST LUDHIANA	11KV	DS S. NAGAR (SPL) DIVN	TECH.-I S. NAGAR (SPL)	D029FL11	K.D.FABRIC	AMR	OK	31.03.2023	Category 1			14058	1200/577/1-1	13.229	NA	Director/D	
B.2446	Central	CITY EAST LUDHIANA	11KV	DS S. NAGAR (SPL) DIVN	TECH.-I S. NAGAR (SPL)	D018FL18	GITANSH	AMR	OK	31.03.2023	Category 2			6430964	1200/577/1-1	0.000	NA	Director/D	
B.2447	Central	CITY EAST LUDHIANA	11KV	DS S. NAGAR (SPL) DIVN	TECH.-I S. NAGAR (SPL)	D018FL11	BODHPGNARH	AMR	OK	31.03.2023	AP 3Phase 3Wire			6679960	1200/577/1-1	1.703	NA	Director/D	
B.2448	Central	CITY EAST LUDHIANA	11KV	DS S. NAGAR (SPL) DIVN	TECH.-I S. NAGAR (SPL)	D018FL05	MANGAL	AMR	OK	31.03.2023	AP 3Phase 3Wire			703825	1200/577/1-1	1.736	NA	Director/D	
B.2449	Central	CITY EAST LUDHIANA	11KV	DS S. NAGAR (SPL) DIVN	TECH.-I S. NAGAR (SPL)	D018FL04	BHOOKRI	AMR	OK	31.03.2023	AP 3Phase 3Wire			5342482	1200/577/1-1	1.802	NA	Director/D	
B.2450	Central	CITY EAST LUDHIANA	11KV	DS S. NAGAR (SPL) DIVN	TECH.-I S. NAGAR (SPL)	D018FL03	HAWAS	AMR	OK	31.03.2023	AP 3Phase 3Wire			24377	900-450/577/1-1	1.945	NA	Director/D	
B.2451	Central	CITY EAST LUDHIANA	11KV	DS S. NAGAR (SPL) DIVN	TECH.-I S. NAGAR (SPL)	D018FL15	KASHI KALAN	AMR	OK	31.03.2023	AP 3Phase 3Wire			102871197	1200/577/1-1	2.063	NA	Director/D	
B.2452	Central	CITY EAST LUDHIANA	11KV	DS S. NAGAR (SPL) DIVN	TECH.-I S. NAGAR (SPL)	D018FL02	METHARBAN	AMR	OK	31.03.2023	AP 3Phase 3Wire			736417	900-450/577/1-1	2.192	NA	Director/D	
B.2453	Central	CITY EAST LUDHIANA	11KV	DS S. NAGAR (SPL) DIVN	TECH.-I S. NAGAR (SPL)	D018FL06	DHERI	AMR	OK	31.03.2023	Category 4			24037	1200/577/1-1	2.644	NA	Director/D	
B.2454	Central	CITY EAST LUDHIANA	11KV	DS S. NAGAR (SPL) DIVN	TECH.-I S. NAGAR (SPL)	D018FL01	DHERI	AMR	OK	31.03.2023	Category 3Wire			7336296	1200/577/1-1	3.331	NA	Director/D	
B.2455	Central	CITY EAST LUDHIANA	11KV	DS S. NAGAR (SPL) DIVN	TECH.-I S. NAGAR (SPL)	B009FL30	AVON COTEX	AMR	OK	31.03.2023	Category 4			10288304	1200/577/1-1	4.637	NA	Director/D	
B.2456	Central	CITY EAST LUDHIANA	11KV	DS S. NAGAR (SPL) DIVN	TECH.-I S. NAGAR (SPL)	D018FL10	SPORTING	AMR	OK	31.03.2023	Category 2			11116872	1200/577/1-1	4.893	NA	Director/D	
B.2457	Central	CITY EAST LUDHIANA	11KV	DS S. NAGAR (SPL) DIVN	TECH.-I S. NAGAR (SPL)	B009FL33	GITANSH INTERNATIONAL	AMR	OK	31.03.2023	Category 4			1461	1200/577/1-1	5.601	NA	Director/D	
B.2458	Central	CITY EAST LUDHIANA	11KV	DS S. NAGAR (SPL) DIVN	TECH.-I S. NAGAR (SPL)	B009FL34	Dashmesh Shellar	AMR	OK	31.03.2023	Category 2			556	900-4				

S.No	Zone	Circle	Voltage Level (kVA)	Division (kVA)	Sub-Division (kVA)	Feeder ID	Feeder Name	Feeder Metering Status (Metered/unmetered/AMR/AM)	Status of Meter (Functional/Non-Functional)	Metering Date (Date of last actual meter reading/communication)	Feeder Type (Agr/Industrial/Mixed)	Status of Communication			Period from 01.04.2021 to 31.03.2022				Sales	Remarks (Source of data)
												% data received through automatically by feeder AMR/AM	Number of hours when meter was unable to communicate in overall	Total Number of hours in the period	Meter S.No	CT/Ratio	Import (kWh)	Export (kWh)		
B.2492	Central	CITY EAST LUDHIANA	11KV	DS S. NAGAR (SPL) DIVN	TECH - II S. NAGAR (SPL)	0004FL41	KESHAV SPINNING MILL	AMR	OK	31.03.2023	Category 4				36831	1200/577/1-1-1	11.345	NA	Director/D	
B.2493	Central	CITY EAST LUDHIANA	11KV	DS S. NAGAR (SPL) DIVN	TECH - II S. NAGAR (SPL)	0004FL46	SHANKAR ROAD	AMR	OK	31.03.2023	Category 2				197863	1200/577/1-1-1	12.357	NA	Director/D	
B.2494	Central	CITY EAST LUDHIANA	11KV	DS S. NAGAR (SPL) DIVN	TECH - II S. NAGAR (SPL)	0004FL07	SHADAN NAGAR	AMR	OK	31.03.2023	Category 1				1687	900/450/577/1-1-1	12.527	NA	Director/D	
B.2495	Central	CITY EAST LUDHIANA	11KV	DS S. NAGAR (SPL) DIVN	TECH - II S. NAGAR (SPL)	0004FL47	LUXMI COLONY	AMR	OK	31.03.2023	Category 1				1004642	1200/577/1-1-1	13.237	NA	Director/D	
B.2496	Central	CITY EAST LUDHIANA	11KV	DS S. NAGAR (SPL) DIVN	TECH - II S. NAGAR (SPL)	0004FL24	GEHEWAL	NON AMR	OK	31.03.2023	Category 2				1681	900/450/577/1-1-1	14.095	NA	Director/D	
B.2497	Central	CITY EAST LUDHIANA	11KV	DS S. NAGAR (SPL) DIVN	TECH - II S. NAGAR (SPL)	0004FL12	NEW SUBASH NAGAR	NON AMR	OK	31.03.2023	Category 1				12527373	1200/577/1-1-1	14.510	NA	Director/D	
B.2498	Central	CITY EAST LUDHIANA	11KV	DS S. NAGAR (SPL) DIVN	TECH - II S. NAGAR (SPL)	0004FL26	MAHARANA PARTAP NAGAR	AMR	OK	31.03.2023	Category 1				1673	1200/577/1-1-1	15.299	NA	Director/D	
B.2499	Central	CITY EAST LUDHIANA	11KV	DS S. NAGAR (SPL) DIVN	TECH - II S. NAGAR (SPL)	0004FL37	TIJAK NAGAR	AMR	OK	31.03.2023	Category 1				525508	1200/577/1-1-1	16.599	NA	Director/D	
B.2500	Central	CITY WEST LUDHIANA	11KV	DS AGAR. NGR. (SPL) DIVN	TECH - III AGAR NAGAR	0002FL08	BARANAHARA FEEDER	AMR	OK	31.03.2023	Category 5-UPS				1114927	1200/577/1-1-1	6.967	NA	Director/D	
B.2501	Central	CITY WEST LUDHIANA	11KV	DS AGAR. NGR. (SPL) DIVN	TECH - III AGAR NAGAR	0002FL15	BASANT NAGAR	AMR	OK	31.03.2023	Category 1				12479621	1200/577/1-1-1	11.734	NA	Director/D	
B.2502	Central	CITY WEST LUDHIANA	11KV	DS AGAR. NGR. (SPL) DIVN	TECH - III AGAR NAGAR	0002FL10	NEW KITCHLU NAGAR	AMR	OK	31.03.2023	Category 1				33462	1200/577/1-1-1	13.130	NA	Director/D	
B.2503	Central	CITY WEST LUDHIANA	11KV	DS AGAR. NGR. (SPL) DIVN	TECH - III AGAR NAGAR	0002FL05	JAINPUR FEEDER	AMR	OK	31.03.2023	AP 3Phase 3Wire				9140976	1200/577/1-1-1	3.052	NA	Director/D	
B.2504	Central	CITY WEST LUDHIANA	11KV	DS AGAR. NGR. (SPL) DIVN	TECH - III AGAR NAGAR	0002FL09	Humran Road	NON AMR	OK	31.03.2023	Category 1				33740	1200/577/1-1-1	8.919	NA	Director/D	
B.2505	Central	CITY WEST LUDHIANA	11KV	DS AGAR. NGR. (SPL) DIVN	TECH - III AGAR NAGAR	0003FL15	11KV FEDM FEEDER	NON AMR	OK	31.03.2023	Category 4				2046556	1200/577/1-1-1	0.815	NA	Director/D	
B.2506	Central	CITY WEST LUDHIANA	11KV	DS AGAR. NGR. (SPL) DIVN	TECH - III AGAR NAGAR	0003FL09	DAIRY COMPLEX	AMR	OK	31.03.2023	Category 1				12479497	1200/577/1-1-1	5.967	NA	Director/D	
B.2507	Central	CITY WEST LUDHIANA	11KV	DS AGAR. NGR. (SPL) DIVN	TECH - III AGAR NAGAR	0003FL19	Rajesh Nagar	AMR	OK	31.03.2023	Category 1				33733	1200/577/1-1-1	7.994	NA	Director/D	
B.2508	Central	CITY WEST LUDHIANA	11KV	DS AGAR. NGR. (SPL) DIVN	TECH - III AGAR NAGAR	0003FL16	JOSHI NAGAR	AMR	OK	31.03.2023	Category 1				12479588	1200/577/1-1-1	7.768	NA	Director/D	
B.2509	Central	CITY WEST LUDHIANA	11KV	DS AGAR. NGR. (SPL) DIVN	TECH - III AGAR NAGAR	0003FL21	22 FUTTI ROAD	NON AMR	OK	31.03.2023	Category 1				33734	1200/577/1-1-1	8.273	NA	Director/D	
B.2510	Central	CITY WEST LUDHIANA	11KV	DS AGAR. NGR. (SPL) DIVN	TECH - III AGAR NAGAR	0003FL13	DURGAPURI	AMR	OK	31.03.2023	Category 1				12479730	1200/577/1-1-1	8.462	NA	Director/D	
B.2511	Central	CITY WEST LUDHIANA	11KV	DS AGAR. NGR. (SPL) DIVN	TECH - III AGAR NAGAR	0003FL17	Mandrep Nagar	AMR	OK	31.03.2023	Category 1				33705	1200/577/1-1-1	9.404	NA	Director/D	
B.2512	Central	CITY WEST LUDHIANA	11KV	DS AGAR. NGR. (SPL) DIVN	TECH - III AGAR NAGAR	0003FL10	HARBHWAL FEEDER	AMR	OK	31.03.2023	Category 1				12479587	1200/577/1-1-1	9.703	NA	Director/D	
B.2513	Central	CITY WEST LUDHIANA	11KV	DS AGAR. NGR. (SPL) DIVN	TECH - III AGAR NAGAR	0003FL05	MAIN BAZAR FEEDER	AMR	OK	31.03.2023	Category 1				12479500	1200/577/1-1-1	10.943	NA	Director/D	
B.2514	Central	CITY WEST LUDHIANA	11KV	DS AGAR. NGR. (SPL) DIVN	TECH - III AGAR NAGAR	0003FL18	Pavitar Nagar	NON AMR	OK	31.03.2023	Category 1				33822	1200/577/1-1-1	11.873	NA	Director/D	
B.2515	Central	CITY WEST LUDHIANA	11KV	DS AGAR. NGR. (SPL) DIVN	TECH - III AGAR NAGAR	0003FL06	MALAKPUR	NON AMR	OK	31.03.2023	Category 1				12479727	1200/577/1-1-1	12.251	NA	Director/D	
B.2516	Central	CITY WEST LUDHIANA	11KV	DS AGAR. NGR. (SPL) DIVN	TECH - III AGAR NAGAR	0003FL08	SHERA PUNJAB	AMR	OK	31.03.2023	Category 1				12479307	1200/577/1-1-1	17.544	NA	Director/D	
B.2517	Central	CITY WEST LUDHIANA	11KV	DS AGAR. NGR. (SPL) DIVN	TECH - III AGAR NGR	0003FL13	Ashu	AMR	OK	31.03.2023	Category 1				5437723	1200/577/1-1-1	0.000	NA	Director/D	
B.2518	Central	CITY WEST LUDHIANA	11KV	DS AGAR. NGR. (SPL) DIVN	TECH - III AGAR NGR	0003FL13	COLONY	AMR	OK	31.03.2023	Category 1				2065510	1200/577/1-1-1	0.422	NA	Director/D	
B.2519	Central	CITY WEST LUDHIANA	11KV	DS AGAR. NGR. (SPL) DIVN	TECH - III AGAR NGR	0002FL28	S.B.S. Nagar	AMR	OK	31.03.2023	Category 1				1245578	1200/577/1-1-1	0.938	NA	Director/D	
B.2520	Central	CITY WEST LUDHIANA	11KV	DS AGAR. NGR. (SPL) DIVN	TECH - III AGAR NGR	0002FL05	11KV PAU	AMR	OK	31.03.2023	Category 4				2068855	1200/577/1-1-1	1.151	NA	Director/D	
B.2521	Central	CITY WEST LUDHIANA	11KV	DS AGAR. NGR. (SPL) DIVN	TECH - III AGAR NGR	0003FL12	PAKHOWAL ROAD	AMR	OK	31.03.2023	Category 1				7336458	1200/577/1-1-1	1.319	NA	Director/D	
B.2522	Central	CITY WEST LUDHIANA	11KV	DS AGAR. NGR. (SPL) DIVN	TECH - III AGAR NGR	0003FL20L	Bharat Nagar	AMR	OK	31.03.2023	Category 1				1953	1200/577/1-1-1	1.633	NA	Director/D	
B.2523	Central	CITY WEST LUDHIANA	11KV	DS AGAR. NGR. (SPL) DIVN	TECH - III AGAR NGR	0003FL14	SARABHA NAGAR	AMR	OK	31.03.2023	Category 1				2067174	1200/577/1-1-1	3.156	NA	Director/D	
B.2524	Central	CITY WEST LUDHIANA	11KV	DS AGAR. NGR. (SPL) DIVN	TECH - III AGAR NGR	0003FL26	FMI	AMR	OK	31.03.2023	Category 1				7336606	1200/577/1-1-1	4.133	NA	Director/D	
B.2525	Central	CITY WEST LUDHIANA	11KV	DS AGAR. NGR. (SPL) DIVN	TECH - III AGAR NGR	0003FL21	Vishal Tower	NON AMR	OK	31.03.2023	Category 1				5295695	1200/577/1-1-1	4.720	NA	Director/D	
B.2526	Central	CITY WEST LUDHIANA	11KV	DS AGAR. NGR. (SPL) DIVN	TECH - III AGAR NGR	0003FL20	SANCHAR COLONY	AMR	OK	31.03.2023	Category 1				1677	1200/577/1-1-1	5.321	NA	Director/D	
B.2527	Central	CITY WEST LUDHIANA	11KV	DS AGAR. NGR. (SPL) DIVN	TECH - III AGAR NGR	0002FL25	Country Home	AMR	OK	31.03.2023	Category 1				7039560	1200/577/1-1-1	5.427	NA	Director/D	
B.2528	Central	CITY WEST LUDHIANA	11KV	DS AGAR. NGR. (SPL) DIVN	TECH - III AGAR NGR	0002FL16	AGAR NAGAR	AMR	OK	31.03.2023	Category 1				2042972	1200/577/1-1-1	5.338	NA	Director/D	
B.2529	Central	CITY WEST LUDHIANA	11KV	DS AGAR. NGR. (SPL) DIVN	TECH - III AGAR NGR	0002FL06	GURDY NAGAR	AMR	OK	31.03.2023	Category 1				7305409	1200/577/1-1-1	6.567	NA	Director/D	
B.2530	Central	CITY WEST LUDHIANA	11KV	DS AGAR. NGR. (SPL) DIVN	TECH - III AGAR NGR	0002FL27	CFC School	AMR	OK	31.03.2023	Category 1				205863	1200/577/1-1-1	6.571	NA	Director/D	
B.2531	Central	CITY WEST LUDHIANA	11KV	DS AGAR. NGR. (SPL) DIVN	TECH - III AGAR NGR	0002FL17	B.R.S NAGAR	AMR	OK	31.03.2023	Category 1				9154262	1200/577/1-1-1	6.616	NA	Director/D	
B.2532	Central	CITY WEST LUDHIANA	11KV	DS AGAR. NGR. (SPL) DIVN	TECH - III AGAR NGR	0002FL22	Mandir wala	AMR	OK	31.03.2023	Category 1				6675532	1200/577/1-1-1	7.593	NA	Director/D	
B.2533	Central	CITY WEST LUDHIANA	11KV	DS AGAR. NGR. (SPL) DIVN	TECH - III AGAR NGR	0002FL10	Tajore Public School	AMR	OK	31.03.2023	Category 1				6007341	1200/577/1-1-1	8.509	NA	Director/D	
B.2534	Central	CITY WEST LUDHIANA	11KV	DS AGAR. NGR. (SPL) DIVN	TECH - III AGAR NGR	0003FL01	SUNNY	AMR	OK	31.03.2023	Category 1				2065830	1200/577/1-1-1	8.465	NA	Director/D	
B.2535	Central	CITY WEST LUDHIANA	11KV	DS AGAR. NGR. (SPL) DIVN	TECH - III AGAR NGR	0002FL21	Gurdev Hospital	AMR	OK	31.03.2023	Category 1				2066633	1200/577/1-1-1	11.721	NA	Director/D	
B.2536	Central	CITY WEST LUDHIANA	11KV	DS AGAR. NGR. (SPL) DIVN	TECH - III AGAR NGR	0003FL08	Milk Plant	AMR	OK	31.03.2023	Category 4				4187957	1200/577/1-1-1	12.816	NA	Director/D	
B.2537	Central	CITY WEST LUDHIANA	11KV	DS AGAR. NGR. (SPL) DIVN	TECH - III AGAR NGR	0002FL13	Park Plaza (DC Complex)	AMR	OK	31.03.2023	Category 1				2067897	1200/577/1-1-1	2.417	NA	Director/D	
B.2538	Central	CITY WEST LUDHIANA	11KV	DS AGAR. NGR. (SPL) DIVN	TECH - III AGAR NGR	0002FL11	MKS-2	AMR	OK	31.03.2023	Category 4				5437681	1200/577/1-1-1	0.774	NA	Director/D	
B.2539	Central	CITY WEST LUDHIANA	11KV	DS AGAR. NGR. (SPL) DIVN	TECH - III AGAR NGR	0002FL12	AGAR NAGAR	AMR	OK	31.03.2023	Category 4				10044471	1200/577/1-1-1	4.004	NA	Director/D	
B.2540	Central	CITY WEST LUDHIANA	11KV	DS AGAR. NGR. (SPL) DIVN	TECH - III AGAR NGR	0002FL03	Housing Board (New)	AMR	OK	31.03.2023	Category 1				10283753	1200/577/1-1-1	3.613	NA	Director/D	
B.2541	Central	CITY WEST LUDHIANA	11KV	DS AGAR. NGR. (SPL) DIVN	TECH - III AGAR NGR	0002FL08	A.S.Motion	NON AMR	OK	31.03.2023	Category 1				10283753	1200/577/1-1-1	4.460	NA	Director/D	
B.2542	Central	CITY WEST LUDHIANA	11KV	DS AGAR. NGR. (SPL) DIVN	TECH - III AGAR NGR	0002FL18	Ferozpur Road	AMR	OK	31.03.2023	Category 1				11114469	1200/577/1-1-1	4.598	NA	Director/D	
B.2543	Central	CITY WEST LUDHIANA	11KV	DS AGAR. NGR. (SPL) DIVN	TECH - III AGAR NGR	0002FL	SHEETLA MANDHIR	NON AMR	OK	31.03.2023	Category 1				583773	1200/577/1-1-1	4.938	NA	Director/D	
B.2544	Central	CITY WEST LUDHIANA	11KV	DS AGAR. NGR. (SPL) DIVN	TECH - III AGAR NGR	0013FL38L	Grand walk	NON AMR	OK	31.03.2023	Category 4				5437675	1200/577/1-1-1	5.481	NA	Director/D	
B.2545	Central	CITY WEST LUDHIANA	11KV	DS AGAR. NGR. (SPL) DIVN	TECH - III AGAR NGR	0002FL10	KAJLAH ROAD	AMR	OK	31.03.2023	Category 1				1114513	1200/577/1-1-1	6.484	NA	Director/D	
B.2546	Central	CITY WEST LUDHIANA	11KV	DS AGAR. NGR. (SPL) DIVN	TECH - III AGAR NGR	0002FL09	MAHAVIR NAGAR	AMR	OK	31.03.2023	Category 1				5437676	1200/577/1-1-1	6.000	NA	Director/D	
B.2547	Central	CITY WEST LUDHIANA																		

S.No	Zone	Circle	Voltage Level (kVA)	Division (kVA)	Sub-Division (kVA)	Feeder ID	Feeder Name	Feeder Metering Status (Metered/unmetered/AMR/AMI)	Status of Meter (Functional/Non-Functional)	Metering Date (Date of last actual meter reading/communication)	Feeder Type (Agri/Industrial/Mixed)	Status of Communication			Period from 01.04.2021 to 31.03.2022				Sales	Remarks (Source of data)
												% data received through automatically if feeder AMR/AMI	Number of hours when meter was unable to communicate in overall	Total Number of hours in the period	Meter S.No	CT/PT ratio	Import (kU)	Export (kU)		
B.2589	Central	CITY WEST LUDHIANA	11KV	DS AGAR, NGR. (SP)	DN TECH. UNIT-II AGAR, NGR	0027FL12	NEW AJIT NAGAR	AMR	OK	31.03.2023	Category 1				2066832	1200/5771-1-1	12.294	NA	Director/D	
B.2590	Central	CITY WEST LUDHIANA	11KV	DS AGAR, NGR. (SP)	DN TECH. UNIT-II AGAR, NGR	0027FL15	Naveen Nagar	AMR	OK	31.03.2023	Category 1				52362	1200/5771-1-1	12.373	NA	Director/D	
B.2591	Central	CITY WEST LUDHIANA	11KV	DS AGAR, NGR. (SP)	DN TECH. UNIT-II AGAR, NGR	0027FL09	Jasmi Nagar	AMR	OK	31.03.2023	Category 1				10288309	1200/5771-1-1	12.929	NA	Director/D	
B.2592	Central	CITY WEST LUDHIANA	11KV	DS AGAR, NGR. (SP)	DN TECH. UNIT-II AGAR, NGR	0023FL11	Chander Nagar	NON AMR	OK	31.03.2023	Category 1				33638	1000/500/5771-1-1	13.572	NA	Director/D	
B.2593	Central	CITY WEST LUDHIANA	11KV	DS AGAR, NGR. (SP)	DN TECH. UNIT-II AGAR, NGR	0002FL15	JASSIAN	AMR	OK	31.03.2023	Category 1				1497	1200/5771-1-1	14.416	NA	Director/D	
B.2594	Central	CITY WEST LUDHIANA	11KV	DS AGAR, NGR. (SP)	DN TECH. UNIT-II AGAR, NGR	0027FL12	11kv chahar	AMR	OK	31.03.2023	AP 3Phase 3Wire				3985	1200/5771-1-1	1.107	NA	Director/D	
B.2595	Central	CITY WEST LUDHIANA	11KV	DS AGAR, NGR. (SP)	DN TECH. UNIT-II AGAR, NGR	0027FL11	11KV NDRF UPS	AMR	OK	31.03.2023	Category 1				4099	1200/5771-1-1	7.042	NA	Director/D	
B.2596	Central	CITY WEST LUDHIANA	11KV	DS CITY WEST (SP)	DN TECH. -I CITY WEST (SP)	0002FL15	MODEL GRAM	AMR	OK	31.03.2023	Category 1				2066960	1200/5771-1-1	2.480	NA	Director/D	
B.2597	Central	CITY WEST LUDHIANA	11KV	DS CITY WEST (SP)	DN TECH. -I CITY WEST (SP)	0020FL01	MALL ROAD	AMR	OK	31.03.2023	Category 1				2067594	1200/5771-1-1	0.000	NA	Director/D	
B.2598	Central	CITY WEST LUDHIANA	11KV	DS CITY WEST (SP)	DN TECH. -I CITY WEST (SP)	0020FL08	KHALSA COLLEGE	AMR	OK	31.03.2023	Category 1				5453617	1200/5771-1-1	0.000	NA	Director/D	
B.2599	Central	CITY WEST LUDHIANA	11KV	DS CITY WEST (SP)	DN TECH. -I CITY WEST (SP)	0020FL10	GHULMAR MANDI	AMR	OK	31.03.2023	Category 1				2066764	1200/5771-1-1	0.000	NA	Director/D	
B.2600	Central	CITY WEST LUDHIANA	11KV	DS CITY WEST (SP)	DN TECH. -I CITY WEST (SP)	0020FL04	NEW COURT	AMR	OK	31.03.2023	Category 4				2067594	1200/5771-1-1	3.041	NA	Director/D	
B.2601	Central	CITY WEST LUDHIANA	11KV	DS CITY WEST (SP)	DN TECH. -I CITY WEST (SP)	0020FL12	STOCK EXCHANGE	AMR	OK	31.03.2023	Category 1				2068005	1200/5771-1-1	4.231	NA	Director/D	
B.2602	Central	CITY WEST LUDHIANA	11KV	DS CITY WEST (SP)	DN TECH. -I CITY WEST (SP)	0020FL03	FEROZGANI MARKET	AMR	OK	31.03.2023	Category 1				5295760	1200/5771-1-1	5.176	NA	Director/D	
B.2603	Central	CITY WEST LUDHIANA	11KV	DS CITY WEST (SP)	DN TECH. -I CITY WEST (SP)	0020FL14	NATIONAL ROAD	AMR	OK	31.03.2023	Category 1				2067231	1200/5771-1-1	7.776	NA	Director/D	
B.2604	Central	CITY WEST LUDHIANA	11KV	DS CITY WEST (SP)	DN TECH. -I CITY WEST (SP)	0020FL11	SATLU CLUB	AMR	OK	31.03.2023	Category 1				2067880	1200/5771-1-1	10.063	NA	Director/D	
B.2605	Central	CITY WEST LUDHIANA	11KV	DS CITY WEST (SP)	DN TECH. -I CITY WEST (SP)	0020FL02	SANT SHER SINGH NAGAR	AMR	OK	31.03.2023	Category 1				5336639	1200/5771-1-1	10.098	NA	Director/D	
B.2606	Central	CITY WEST LUDHIANA	11KV	DS CITY WEST (SP)	DN TECH. -I CITY WEST (SP)	0033FL09	POLICE LINE	AMR	OK	31.03.2023	Category 1				33837	1000/500/5771-1-1	0.185	NA	Director/D	
B.2607	Central	CITY WEST LUDHIANA	11KV	DS CITY WEST (SP)	DN TECH. -I CITY WEST (SP)	0033FL01	Guru Nanak Stadium	AMR	OK	31.03.2023	Category 1				33833	1000/500/5771-1-1	2.401	NA	Director/D	
B.2608	Central	CITY WEST LUDHIANA	11KV	DS CITY WEST (SP)	DN TECH. -I CITY WEST (SP)	0033FL03	D.I. Residence	AMR	OK	31.03.2023	Category 1				33719	1000/500/5771-1-1	2.206	NA	Director/D	
B.2609	Central	CITY WEST LUDHIANA	11KV	DS CITY WEST (SP)	DN TECH. -I CITY WEST (SP)	0033FL02	Sadar Thana	AMR	OK	31.03.2023	Category 1				33825	1000/500/5771-1-1	6.085	NA	Director/D	
B.2610	Central	CITY WEST LUDHIANA	11KV	DS CITY WEST (SP)	DN TECH. -I CITY WEST (SP)	0033FL06	Rani Jhansi Road	AMR	OK	31.03.2023	Category 1				33841	1000/500/5771-1-1	7.329	NA	Director/D	
B.2611	Central	CITY WEST LUDHIANA	11KV	DS CITY WEST (SP)	DN TECH. -I CITY WEST (SP)	0033FL07	Bharat Nagar	AMR	OK	31.03.2023	Category 1				33669	1000/500/5771-1-1	8.481	NA	Director/D	
B.2612	Central	CITY WEST LUDHIANA	11KV	DS CITY WEST (SP)	DN TECH. -I CITY WEST (SP)	0033FL10	Mali Enclave	AMR	OK	31.03.2023	Category 1				33839	1000/500/5771-1-1	8.596	NA	Director/D	
B.2613	Central	CITY WEST LUDHIANA	11KV	DS CITY WEST (SP)	DN TECH. -I CITY WEST (SP)	0033FL05	Dandi Swami	AMR	OK	31.03.2023	Category 1				33839	1000/500/5771-1-1	10.223	NA	Director/D	
B.2614	Central	CITY WEST LUDHIANA	11KV	DS CITY WEST (SP)	DN TECH. -I CITY WEST (SP)	0033FL17	SHAI MOHALLA	AMR	OK	31.03.2023	Category 1				33832	1000/500/5771-1-1	10.505	NA	Director/D	
B.2615	Central	CITY WEST LUDHIANA	11KV	DS CITY WEST (SP)	DN TECH. -I CITY WEST (SP)	0033FL08	Prince	AMR	OK	31.03.2023	Category 1				33841	1000/500/5771-1-1	10.938	NA	Director/D	
B.2616	Central	CITY WEST LUDHIANA	11KV	DS CITY WEST (SP)	DN TECH. -I CITY WEST (SP)	0033FL04	Ram Nagar	NON AMR	OK	31.03.2023	Category 1				33702	1000/500/5771-1-1	11.894	NA	Director/D	
B.2617	Central	CITY WEST LUDHIANA	11KV	DS CITY WEST (SP)	DN TECH. -I CITY WEST (SP)	0001FL02	CIVIL LINE	NON AMR	OK	31.03.2023	Category 1				12479663	400/200/5-5	0.000	NA	Director/D	
B.2618	Central	CITY WEST LUDHIANA	11KV	DS CITY WEST (SP)	DN TECH. -I CITY WEST (SP)	0003FL14	KUNDAN WOOD	NON AMR	OK	31.03.2023	Category 1				1479	1200/5771-1-1	14.059	NA	Director/D	
B.2619	Central	CITY WEST LUDHIANA	11KV	DS CITY WEST (SP)	DN TECH. -I CITY WEST (SP)	0003FL11	ROSE GARDEN	AMR	OK	31.03.2023	Category 1				12479500	1200/5771-1-1	0.000	NA	Director/D	
B.2620	Central	CITY WEST LUDHIANA	11KV	DS CITY WEST (SP)	DN TECH. -I CITY WEST (SP)	0003FL04	Bharti Realty	AMR	OK	31.03.2023	Category 1				33528	1200/5771-1-1	0.000	NA	Director/D	
B.2621	Central	CITY WEST LUDHIANA	11KV	DS CITY WEST (SP)	DN TECH. -I CITY WEST (SP)	0003FL02	COLLEGE ROAD	NON AMR	OK	31.03.2023	Category 1				12479728	1200/5771-1-1	3.892	NA	Director/D	
B.2622	Central	CITY WEST LUDHIANA	11KV	DS CITY WEST (SP)	DN TECH. -I CITY WEST (SP)	0003FL04	KITCHU NAGAR	NON AMR	OK	31.03.2023	Category 1				12479729	1200/5771-1-1	4.667	NA	Director/D	
B.2623	Central	CITY WEST LUDHIANA	11KV	DS CITY WEST (SP)	DN TECH. -I CITY WEST (SP)	0003FL12	DUSHERA GROUND	AMR	OK	31.03.2023	Category 1				12479591	1200/5771-1-1	6.115	NA	Director/D	
B.2624	Central	CITY WEST LUDHIANA	11KV	DS CITY WEST (SP)	DN TECH. -I CITY WEST (SP)	0003FL07	CEMETRY ROAD	AMR	OK	31.03.2023	Category 1				12479731	1200/5771-1-1	7.253	NA	Director/D	
B.2625	Central	CITY WEST LUDHIANA	11KV	DS CITY WEST (SP)	DN TECH. -I CITY WEST (SP)	0003FL20	BVM SCHOOL	AMR	OK	31.03.2023	Category 1				33728	1200/5771-1-1	8.343	NA	Director/D	
B.2626	Central	CITY WEST LUDHIANA	11KV	DS CITY WEST (SP)	DN TECH. -I CITY WEST (SP)	0003FL01	JRKAR NAGAR	NON AMR	OK	31.03.2023	Category 1				12479489	1200/5771-1-1	12.120	NA	Director/D	
B.2627	Central	CITY WEST LUDHIANA	11KV	DS CITY WEST (SP)	DN TECH. -I CITY WEST (SP)	0003FL03	NEW DMC	AMR	OK	31.03.2023	Category 4				7042930	1200/5771-1-1	19.101	NA	Director/D	
B.2628	Central	CITY WEST LUDHIANA	11KV	DS CITY WEST (SP)	DN TECH. -I CITY WEST (SP)	0030FL07	MARITIOUS SCHOOL	NON AMR	OK	31.03.2023	Category 4				23454	1200/5771-1-1	0.159	NA	Director/D	
B.2629	Central	CITY WEST LUDHIANA	11KV	DS CITY WEST (SP)	DN TECH. -I CITY WEST (SP)	0030FL03	TELEPHONE EXCHANGE	AMR	OK	31.03.2023	Category 1				12093503	1200/5771-1-1	1.321	NA	Director/D	
B.2630	Central	CITY WEST LUDHIANA	11KV	DS CITY WEST (SP)	DN TECH. -I CITY WEST (SP)	0030FL08	Maharaja Nagar	AMR	OK	31.03.2023	Category 1				33767	1200/5771-1-1	4.888	NA	Director/D	
B.2631	Central	CITY WEST LUDHIANA	11KV	DS CITY WEST (SP)	DN TECH. -I CITY WEST (SP)	0030FL1	11 KV ARBIT CHOWK	NON AMR	OK	31.03.2023	Category 1				33779	1200/5771-1-1	4.851	NA	Director/D	
B.2632	Central	CITY WEST LUDHIANA	11KV	DS CITY WEST (SP)	DN TECH. -I CITY WEST (SP)	0030FL01	GOBING NAGAR	AMR	OK	31.03.2023	Category 1				12093479	1200/5771-1-1	6.495	NA	Director/D	
B.2633	Central	CITY WEST LUDHIANA	11KV	DS CITY WEST (SP)	DN TECH. -I CITY WEST (SP)	0030FL04	MAYA NAGAR	NON AMR	OK	31.03.2023	Category 1				12093447	1200/5771-1-1	10.135	NA	Director/D	
B.2634	Central	CITY WEST LUDHIANA	11KV	DS CITY WEST (SP)	DN TECH. -I CITY WEST (SP)	0030FL05	TAGORE NAGAR	AMR	OK	31.03.2023	Category 1				12093425	1200/5771-1-1	11.646	NA	Director/D	
B.2635	Central	CITY WEST LUDHIANA	11KV	DS CITY WEST (SP)	DN TECH. -I CITY WEST (SP)	0030FL16	GHULMAR MANDI	NON AMR	OK	31.03.2023	Category 1				33721	1200/5771-1-1	11.886	NA	Director/D	
B.2636	Central	CITY WEST LUDHIANA	11KV	DS CITY WEST (SP)	DN TECH. -I CITY WEST (SP)	0023FL13	W/O	NON AMR	OK	31.03.2023	Category 4				2066964	1200/5771-1-1	0.000	NA	Director/D	
B.2637	Central	CITY WEST LUDHIANA	11KV	DS CITY WEST (SP)	DN TECH. -II CITY WEST	0023FL12	QADIAN	AMR	OK	31.03.2023	AP 3Phase 3Wire				7035644	1200/5771-1-1	1.368	NA	Director/D	
B.2638	Central	CITY WEST LUDHIANA	11KV	DS CITY WEST (SP)	DN TECH. -II CITY WEST	0023FL14	B M V	NON AMR	OK	31.03.2023	Category 4				34035	1200/5771-1-1	1.518	NA	Director/D	
B.2639	Central	CITY WEST LUDHIANA	11KV	DS CITY WEST (SP)	DN TECH. -II CITY WEST	0023FL30	DIMPLE PACKAGE	NON AMR	OK	31.03.2023	Category 1				2066514	1200/5771-1-1	2.639	NA	Director/D	
B.2640	Central	CITY WEST LUDHIANA	11KV	DS CITY WEST (SP)	DN TECH. -II CITY WEST	0023FL07	JAIN	NON AMR	OK	31.03.2023	Category 2				7042923	1200/5771-1-1	3.176	NA	Director/D	
B.2641	Central	CITY WEST LUDHIANA	11KV	DS CITY WEST (SP)	DN TECH. -II CITY WEST	0023FL10	VEERAM	AMR	OK	31.03.2023	Category 4				12093602	1200/5771-1-1	3.235	NA	Director/D	
B.2642	Central	CITY WEST LUDHIANA	11KV	DS CITY WEST (SP)	DN TECH. -II CITY WEST	0023FL10	DECO	NON AMR	OK	31.03.2023	Category 1				33689	1200/5771-1-1	3.497	NA	Director/D	
B.2643	Central	CITY WEST LUDHIANA	11KV	DS CITY WEST (SP)	DN TECH. -II CITY WEST	0023FL30	SEWERAGE BOARD	AMR	OK	31.03.2023	Category 4				5341553	1200/5771-1-1	4.837	NA	Director/D	
B.2644	Central	CITY WEST LUDHIANA	11KV	DS CITY WEST (SP)	DN TECH. -II CITY WEST	0023FL13	Thaper	NON AMR	OK	31.03.2023	Category 1				33472	1200/5771-1-1	6.321	NA	Director/D	
B.2645	Central	CITY WEST LUDHIANA	11KV	DS CITY WEST (SP)	DN TECH. -II CITY WEST	0023FL01	HEMKUNTI	AMR	OK	31.03.2023	Category 1				7336803	1200/5771-1-1	6.835	NA	Director/D	
B.2646	Central	CITY WEST LUDHIANA	11KV	DS CITY WEST (SP)	DN TECH. -II CITY WEST	0023FL15	OCTAVE	AMR	OK	31.03.2023	Category 1				33743	1200/5771-1-1	8.433	NA	Director/D	
B.2647	Central	CITY WEST LUDHIANA	11KV	DS CITY WEST (SP)	DN TECH. -II CITY WEST	0023FL11	Kuldeep Nagar	NON AMR	OK	31.03.2023	Category 1				33628	1200/5771-1-1	8.727	NA	Director/D	
B.2648	Central	CITY WEST LUDHIANA	11KV	DS CITY WEST (SP)	DN TECH. -II CITY WEST	0023FL02	B.K.PAPER	NON AMR	OK	31.03.2023	Category 1				2068212	1200/5771-1-1	9.259	NA	Director/D	
B.2649	Central	CITY WEST LUDHIANA	11KV	DS CITY WEST (SP)	DN TECH. -II CITY WEST	0023FL03	GURU HAR RAI	NON AMR	OK	31.03.2023	Category 1				2068627	1200/5771-1-1	10.763	NA	Director/D	
B.2650	Central	CITY WEST LUDHIANA	11KV	DS CITY WEST (SP)	DN TECH. -II CITY WEST	0023FL04	BHATTIAN	NON AMR	OK	31.03.2023	Category 1				5437734	1200/5771-1-1	12.557	NA	Director/D	
B.2651	Central	CITY WEST LUDHIANA	11KV	DS CITY WEST (SP)	DN TECH. -II CITY WEST	0023FL29	LARK FEEDER	NON AMR	OK	31.03.2023	Category 1				33710	1200/5771-1-1	13.790	NA	Director/D	
B.2652	Central	CITY WEST LUDHIANA	11KV	DS CITY WEST (SP)	DN TECH. -II CITY WEST	0001FL06	KAPOOR HOSPITAL	NON AMR	OK	31.03.2023	Category 1				1537	1200/5771-1-1	0.253	NA	Director/D	
B.2653	Central	CITY WEST LUDHIANA	11KV	DS CITY WEST (SP)	DN TECH															

S.No	Zone	Circle	Voltage Level (kVA)	Division (kVA)	Sub-Division (kVA)	Feeder ID	Feeder Name	Feeder Metering Status (Metered/unmetered/AMR/AMI)	Status of Meter (Functional/Non-Functional)	Metering Date (Date of last actual meter reading/communication)	Feeder Type (Agr/Industrial/Mixed)	Status of Communication			Period from 01.04.2021 to 31.03.2022				Sales	Remarks (Source of data)
												% data received through automatically if feeder AMR/AMI	Number of hours when meter was unable to communicate in overall	Total Number of hours in the period	Meter S.No	CT/PT ratio	Import (kWh)	Export (kWh)		
B.2686	Central	CITY WEST UDHIANA	11KV	DS ESTATE (SPL) DIVN.	TECH.-III ESTATE (SPL)	8003FL26	Varun	AMR	OK	31.03.2023	Category 4				5254556	1200/577/1-1-1	0.008	NA	Director/D	
B.2687	Central	CITY WEST UDHIANA	11KV	DS ESTATE (SPL) DIVN.	TECH.-III ESTATE (SPL)	8003FL01	MAZARA	AMR	OK	31.03.2023	AP 3Phase 3Wire				5437709	1200/577/1-1-1	1.000	NA	Director/D	
B.2688	Central	CITY WEST UDHIANA	11KV	DS ESTATE (SPL) DIVN.	TECH.-III ESTATE (SPL)	8003FL05	PAWAN	AMR	OK	31.03.2023	AP 3Phase 3Wire				9141032	1200/577/1-1-1	1.009	NA	Director/D	
B.2689	Central	CITY WEST UDHIANA	11KV	DS ESTATE (SPL) DIVN.	TECH.-III ESTATE (SPL)	8003FL21	SOHA SAR	AMR	OK	31.03.2023	Category 2				9951	1200/577/1-1-1	1.363	NA	Director/D	
B.2690	Central	CITY WEST UDHIANA	11KV	DS ESTATE (SPL) DIVN.	TECH.-III ESTATE (SPL)	8003FL25	Unadapur	AMR	OK	31.03.2023	Category 2				4263565	1200/577/1-1-1	3.354	NA	Director/D	
B.2691	Central	CITY WEST UDHIANA	11KV	DS ESTATE (SPL) DIVN.	TECH.-III ESTATE (SPL)	8003FL06	NATT-MAZARA	AMR	OK	31.03.2023	Category 5-UPS				4221006	1200/577/1-1-1	3.500	NA	Director/D	
B.2692	Central	CITY WEST UDHIANA	11KV	DS ESTATE (SPL) DIVN.	TECH.-III ESTATE (SPL)	8003FL20	JAIN SONS	AMR	OK	31.03.2023	Category 4				35263	1200/577/1-1-1	3.520	NA	Director/D	
B.2693	Central	CITY WEST UDHIANA	11KV	DS ESTATE (SPL) DIVN.	TECH.-III ESTATE (SPL)	8003FL09	SAKSHI	AMR	OK	31.03.2023	Category 2				1028283	1200/577/1-1-1	3.585	NA	Director/D	
B.2694	Central	CITY WEST UDHIANA	11KV	DS ESTATE (SPL) DIVN.	TECH.-III ESTATE (SPL)	8003FL15	TIBA	AMR	OK	31.03.2023	AP 3Phase 3Wire				7336693	1200/577/1-1-1	4.965	NA	Director/D	
B.2695	Central	CITY WEST UDHIANA	11KV	DS ESTATE (SPL) DIVN.	TECH.-III ESTATE (SPL)	8003FL07	RETAVISION	AMR	OK	31.03.2023	Category 2				2066094	1200/577/1-1-1	4.805	NA	Director/D	
B.2696	Central	CITY WEST UDHIANA	11KV	DS ESTATE (SPL) DIVN.	TECH.-III ESTATE (SPL)	8003FL24	NANDPUR	AMR	OK	31.03.2023	Category 1				102352	1200/577/1-1-1	5.898	NA	Director/D	
B.2697	Central	CITY WEST UDHIANA	11KV	DS ESTATE (SPL) DIVN.	TECH.-III ESTATE (SPL)	8003FL22	UCO	AMR	OK	31.03.2023	Category 2				1988	1200/577/1-1-1	6.653	NA	Director/D	
B.2698	Central	CITY WEST UDHIANA	11KV	DS ESTATE (SPL) DIVN.	TECH.-III ESTATE (SPL)	8003FL17	KIRAN FOUNDRY	AMR	OK	31.03.2023	Category 2				1111803	1200/577/1-1-1	7.043	NA	Director/D	
B.2699	Central	CITY WEST UDHIANA	11KV	DS ESTATE (SPL) DIVN.	TECH.-III ESTATE (SPL)	8003FL19	OSTER	AMR	OK	31.03.2023	Category 2				12479394	1200/577/1-1-1	7.226	NA	Director/D	
B.2700	Central	CITY WEST UDHIANA	11KV	DS ESTATE (SPL) DIVN.	TECH.-III ESTATE (SPL)	8003FL04	DHROH	AMR	OK	31.03.2023	Category 1				2069080	1200/577/1-1-1	8.127	NA	Director/D	
B.2701	Central	CITY WEST UDHIANA	11KV	DS ESTATE (SPL) DIVN.	TECH.-III ESTATE (SPL)	8003FL10	SAJAN	AMR	OK	31.03.2023	Category 4				4263528	1200/577/1-1-1	8.766	NA	Director/D	
B.2702	Central	CITY WEST UDHIANA	11KV	DS ESTATE (SPL) DIVN.	TECH.-III ESTATE (SPL)	8003FL23	Ganpati	AMR	OK	31.03.2023	Category 2				4263565	1200/577/1-1-1	8.857	NA	Director/D	
B.2703	Central	CITY WEST UDHIANA	11KV	DS ESTATE (SPL) DIVN.	TECH.-III ESTATE (SPL)	8003FL03	KIRPAL STEEL	AMR	OK	31.03.2023	Category 1				4221034	1200/577/1-1-1	9.157	NA	Director/D	
B.2704	Central	CITY WEST UDHIANA	11KV	DS ESTATE (SPL) DIVN.	TECH.-III ESTATE (SPL)	8003FL18	BANSAL	AMR	OK	31.03.2023	Category 4				144252	1200/577/1-1-1	9.936	NA	Director/D	
B.2705	Central	CITY WEST UDHIANA	11KV	DS ESTATE (SPL) DIVN.	TECH.-III ESTATE (SPL)	8003FL14	MINKA	AMR	OK	31.03.2023	Category 2				7336651	1200/577/1-1-1	10.549	NA	Director/D	
B.2706	Central	CITY WEST UDHIANA	11KV	DS ESTATE (SPL) DIVN.	TECH.-III ESTATE (SPL)	8003FL16	SRI STEEL	AMR	OK	31.03.2023	Category 2				7336693	1200/577/1-1-1	13.497	NA	Director/D	
B.2707	Central	CITY WEST UDHIANA	11KV	DS ESTATE (SPL) DIVN.	TECH.-III ESTATE (SPL)	8003FL02	HIGHWAY	AMR	OK	31.03.2023	Category 2				10282762	1200/577/1-1-1	14.656	NA	Director/D	
B.2708	Central	CITY WEST UDHIANA	11KV	DS ESTATE (SPL) DIVN.	TECH.-III ESTATE (SPL)	8003FL12	TAYAL	AMR	OK	31.03.2023	Category 2				11052021	1200/577/1-1-1	28.750	NA	Director/D	
B.2709	Central	CITY WEST UDHIANA	11KV	DS ESTATE (SPL) DIVN.	TECH.-III ESTATE (SPL)	0012FL41	JF FERRIC	AMR	OK	31.03.2023	Category 4				525508	1200/577/1-1-1	4.819	NA	Director/D	
B.2710	Central	CITY WEST UDHIANA	11KV	DS ESTATE (SPL) DIVN.	TECH.-III ESTATE (SPL)	0012FL40	EASTMAN	AMR	OK	31.03.2023	Category 3				325362	1200/577/1-1-1	7.234	NA	Director/D	
B.2711	Central	CITY WEST UDHIANA	11KV	DS ESTATE (SPL) DIVN.	TECH.-III ESTATE (SPL)	0012FL15	JINDAL COTTEX	AMR	OK	31.03.2023	Category 4				30239	1200/577/1-1-1	21.479	NA	Director/D	
B.2712	Central	CITY WEST UDHIANA	11KV	DS ESTATE (SPL) DIVN.	TECH.-III ESTATE (SPL)	0002FL04	PAHMI PALM GARDEN COLONY	AMR	OK	31.03.2023	Category 1				15194827	1200/577/1-1-1	0.815	NA	Director/D	
B.2713	Central	CITY WEST UDHIANA	11KV	DS ESTATE (SPL) DIVN.	TECH.-III ESTATE (SPL)	0002FL03	SALINI	AMR	OK	31.03.2023	AP 3Phase 3Wire				15194566	1200/577/1-1-1	1.055	NA	Director/D	
B.2714	Central	CITY WEST UDHIANA	11KV	DS ESTATE (SPL) DIVN.	TECH.-III ESTATE (SPL)	0002FL05	BILGA	AMR	OK	31.03.2023	Category 5-UPS				15193890	1200/577/1-1-1	4.484	NA	Director/D	
B.2715	Central	CITY WEST UDHIANA	11KV	DS ESTATE (SPL) DIVN.	TECH.-III ESTATE (SPL)	00020002	Pact-1	AMR	OK	31.03.2023	Category 2				15194758	1200/577/1-1-1	12.942	NA	Director/D	
B.2716	Central	CITY WEST UDHIANA	11KV	DS ESTATE (SPL) DIVN.	TECH.-III ESTATE (SPL)	0002FL01	ANRO NEW	AMR	OK	31.03.2023	Category 3				15193920	1200/577/1-1-1	13.903	NA	Director/D	
B.2717	Central	CITY WEST UDHIANA	11KV	DS ESTATE (SPL) DIVN.	TECH.-III ESTATE (SPL)	0002FL06	PNKAR	AMR	OK	31.03.2023	Category 2				54960	1200/577/1-1-1	14.959	NA	Director/D	
B.2718	Central	CITY WEST UDHIANA	11KV	DS ESTATE (SPL) DIVN.	TECH.-III ESTATE (SPL)	0001FL02	AERODRUM(AIRPORT)	AMR	OK	31.03.2023	Category 3				2068663	1200/577/1-1-1	0.000	NA	Director/D	
B.2719	Central	CITY WEST UDHIANA	11KV	DS ESTATE (SPL) DIVN.	TECH.-III ESTATE (SPL)	0001FL01	JAIN	AMR	OK	31.03.2023	Category 2				2666562	1200/577/1-1-1	0.612	NA	Director/D	
B.2720	Central	CITY WEST UDHIANA	11KV	DS ESTATE (SPL) DIVN.	TECH.-III ESTATE (SPL)	0001FL04	MANGLI	AMR	OK	31.03.2023	AP 3Phase 3Wire				9141031	1200/577/1-1-1	2.476	NA	Director/D	
B.2721	Central	CITY WEST UDHIANA	11KV	DS ESTATE (SPL) DIVN.	TECH.-III ESTATE (SPL)	0001FL06	AMR	OK	31.03.2023	AP 3Phase 3Wire				5437508	1200/577/1-1-1	3.837	NA	Director/D		
B.2722	Central	CITY WEST UDHIANA	11KV	DS ESTATE (SPL) DIVN.	TECH.-III ESTATE (SPL)	0001FL21	KURAMA ROLLING	NON AMR	OK	31.03.2023	Category 2				10248318	1200/577/1-1-1	4.307	NA	Director/D	
B.2723	Central	CITY WEST UDHIANA	11KV	DS ESTATE (SPL) DIVN.	TECH.-III ESTATE (SPL)	0001FL24	PREMIUM COMPLEX	AMR	OK	31.03.2023	Category 2				30280	1200/577/1-1-1	6.366	NA	Director/D	
B.2724	Central	CITY WEST UDHIANA	11KV	DS ESTATE (SPL) DIVN.	TECH.-III ESTATE (SPL)	0001FL12	SINHA	AMR	OK	31.03.2023	Category 2				2067648	1200/577/1-1-1	6.352	NA	Director/D	
B.2725	Central	CITY WEST UDHIANA	11KV	DS ESTATE (SPL) DIVN.	TECH.-III ESTATE (SPL)	0001FL03	SANHEWAL	AMR	OK	31.03.2023	Category 1				20675510	1200/577/1-1-1	7.854	NA	Director/D	
B.2726	Central	CITY WEST UDHIANA	11KV	DS ESTATE (SPL) DIVN.	TECH.-III ESTATE (SPL)	0001FL17	KOHARA RD	AMR	OK	31.03.2023	Category 1				11117335	1200/577/1-1-1	8.079	NA	Director/D	
B.2727	Central	CITY WEST UDHIANA	11KV	DS ESTATE (SPL) DIVN.	TECH.-III ESTATE (SPL)	0001FL18	KANGROD	AMR	OK	31.03.2023	Category 4				30252	1200/577/1-1-1	8.336	NA	Director/D	
B.2728	Central	CITY WEST UDHIANA	11KV	DS ESTATE (SPL) DIVN.	TECH.-III ESTATE (SPL)	0001FL10	YARDHARD	AMR	OK	31.03.2023	Category 2				2068876	1200/577/1-1-1	8.817	NA	Director/D	
B.2729	Central	CITY WEST UDHIANA	11KV	DS ESTATE (SPL) DIVN.	TECH.-III ESTATE (SPL)	0001FL11	SARDAR	AMR	OK	31.03.2023	Category 2				2066589	1200/577/1-1-1	9.109	NA	Director/D	
B.2730	Central	CITY WEST UDHIANA	11KV	DS ESTATE (SPL) DIVN.	TECH.-III ESTATE (SPL)	0001FL26	Purana Bazar	NON AMR	OK	31.03.2023	Category 1				35263	1200/577/1-1-1	9.203	NA	Director/D	
B.2731	Central	CITY WEST UDHIANA	11KV	DS ESTATE (SPL) DIVN.	TECH.-III ESTATE (SPL)	0001FL23	PARMATMA STEEL	AMR	OK	31.03.2023	Category 2				30258	1200/577/1-1-1	9.355	NA	Director/D	
B.2732	Central	CITY WEST UDHIANA	11KV	DS ESTATE (SPL) DIVN.	TECH.-III ESTATE (SPL)	0001FL15	SPORTING	AMR	OK	31.03.2023	Category 2				2067668	1200/577/1-1-1	9.702	NA	Director/D	
B.2733	Central	CITY WEST UDHIANA	11KV	DS ESTATE (SPL) DIVN.	TECH.-III ESTATE (SPL)	0001FL09	SAHJ METAL	AMR	OK	31.03.2023	Category 1				7030219	1200/577/1-1-1	9.865	NA	Director/D	
B.2734	Central	CITY WEST UDHIANA	11KV	DS ESTATE (SPL) DIVN.	TECH.-III ESTATE (SPL)	0001FL20	SHARMAN SHAWL	AMR	OK	31.03.2023	Category 4				6701806	1200/577/1-1-1	11.241	NA	Director/D	
B.2735	Central	CITY WEST UDHIANA	11KV	DS ESTATE (SPL) DIVN.	TECH.-III ESTATE (SPL)	0001FL19	LUXMI SPINNING	AMR	OK	31.03.2023	Category 4				7336814	1200/577/1-1-1	12.342	NA	Director/D	
B.2736	Central	CITY WEST UDHIANA	11KV	DS ESTATE (SPL) DIVN.	TECH.-III ESTATE (SPL)	0001FL22	GOBINDGARH	AMR	OK	31.03.2023	Category 1				2066990	1200/577/1-1-1	13.489	NA	Director/D	
B.2737	Central	CITY WEST UDHIANA	11KV	DS ESTATE (SPL) DIVN.	TECH.-III ESTATE (SPL)	0001FL08	MULLARD	AMR	OK	31.03.2023	Category 2				9154067	1200/577/1-1-1	15.589	NA	Director/D	
B.2738	Central	CITY WEST UDHIANA	11KV	DS ESTATE (SPL) DIVN.	TECH.-III ESTATE (SPL)	0001FL16	SHARMANI	AMR	OK	31.03.2023	Category 2				2063932	1200/577/1-1-1	18.368	NA	Director/D	
B.2739	Central	CITY WEST UDHIANA	11KV	DS ESTATE (SPL) DIVN.	TECH.-III ESTATE (SPL)	0001FL13	ADAR	AMR	OK	31.03.2023	Category 3				1027508	1200/577/1-1-1	22.286	NA	Director/D	
B.2740	Central	CITY WEST UDHIANA	11KV	DS ESTATE (SPL) DIVN.	TECH.-III ESTATE (SPL)	T130FL16	MARUTI ALLOY	AMR	OK	31.03.2023	Category 3				125478	400-200/5-5	18.330	NA	Director/D	
B.2741	Central	CITY WEST UDHIANA	11KV	DS ESTATE (SPL) DIVN.	TECH.-III ESTATE (SPL)	T130FL14	SRI Steel	Not available	OK	31.03.2023	Category 2				124587	900-450/577/1-1-1	19.957	NA	Director/D	
B.2742	Central	CITY WEST UDHIANA	66KV	DS ESTATE (SPL) DIVN.	TECH.-III ESTATE (SPL)	8003DL08	VALLABH TEXTILE (Consumer End)	Not available	OK	31.03.2023	Category 4				Not available	Not available	3.630	NA	Director/D	
B.2743	Central	CITY WEST UDHIANA	66KV	DS ESTATE (SPL) DIVN.	TECH.-III ESTATE (SPL)	8003DL09	SPORTING	Not available	OK	31.03.2023	Category 4				Not available	Not available	63.769	NA	Director/D	
B.2744	Central	CITY WEST UDHIANA	66KV	DS ESTATE (SPL) DIVN.	TECH.-III ESTATE (SPL)	8003DL07	GANG ACRYLIC	Not available	OK	31.03.2023	Category 4				Not available	Not available	76.546	NA	Director/D	
B.2745	Central	CITY WEST UDHIANA	11KV	DS ESTATE (SPL) DIVN.	TECH.-III ESTATE (SPL)	0001DL01	AARTI INTENATIONAL	AMR	OK	31.03.2023	Category 2				Not available	Not available	126.075	NA	Director/D	
B.2746	Central	CITY WEST UDHIANA	11KV	DS ESTATE (SPL) DIVN.	TECH. UNIT-I ESTATE	0005FL18	MURAR PURA	NON AMR	OK	31.03.2023	Category 1				33777	1200/577/1-1-1	0.000	NA	Director/D	
B.2747	Central	CITY WEST UDHIANA	11KV	DS ESTATE (SPL) DIVN.	TECH. UNIT-I ESTATE	0005FL13	NANAKPURI	NON AMR	OK	31.03.2023	Category 1				12479304	1200/577/1-1-1	7.055	NA	Director/D	
B.2748	Central	CITY WEST UDHIANA	11KV	DS ESTATE (SPL) DIVN.	TECH. UNIT-I ESTATE	0005FL07	MILLERGANJ	AMR	OK	31.03.2023	Category 1				12479639	1200/577/1-1-1	10.552	NA	Director/D	
B.2749	Central	CITY WEST UDHIANA	11KV	DS ESTATE (SPL) DIVN.	TECH. UNIT-I ESTATE	0001FL04	RANGARHIA COLLEGE	AMR	OK	31.0										

S.No	Zone	Circle	Voltage Level (kVA)	Division (kVA)	Sub-Division (kVA)	Feeder Metering Status (Metered/unmetered/AMR/AMI)	Status of Meter (Functional/Non-Functional)	Metering Date (Date of last actual meter reading/communication)	Feeder Type (Agr/Industrial/Mixed)	Status of Communication			Period from 01.04.2021 to 31.03.2022			Sales	Remarks (Source of data)	
										% data received through automatically if feeder AMR/AMI	Number of hours when meter was unable to communicate in overall	Total Number of hours in the period	Meter S.No	CT/Ratio	Import (kU)			Export (kU)
B.2783	Central	CITY WEST LU DHIANA	11KV	DS ESTATE (SPL) DIVN.	TECH. UNIT-II ESTATE	D001FL16	BHOGAL	NON AMR	OK	31.03.2023	Category 2			12479521	1200/577/1-1-1	9.737	NA	Director/D
B.2784	Central	CITY WEST LU DHIANA	11KV	DS ESTATE (SPL) DIVN.	TECH. UNIT-II ESTATE	D001FL127	DHANDARI	NON AMR	OK	31.03.2023	Category 2			12479554	1200/577/1-1-1	9.918	NA	Director/D
B.2785	Central	CITY WEST LU DHIANA	11KV	DS ESTATE (SPL) DIVN.	TECH. UNIT-II ESTATE	D001FL03	DHARA ROAD	NON AMR	OK	31.03.2023	Category 2			12479308	1200/577/1-1-1	9.919	NA	Director/D
B.2786	Central	CITY WEST LU DHIANA	11KV	DS ESTATE (SPL) DIVN.	TECH. UNIT-II ESTATE	D001FL28	ANAR PURI	NON AMR	OK	31.03.2023	Category 2			12479525	1200/577/1-1-1	10.086	NA	Director/D
B.2787	Central	CITY WEST LU DHIANA	11KV	DS ESTATE (SPL) DIVN.	TECH. UNIT-II ESTATE	D001FL10	JANTA NAGAR	NON AMR	OK	31.03.2023	Category 1			12479321	1200/577/1-1-1	10.933	NA	Director/D
B.2788	Central	CITY WEST LU DHIANA	11KV	DS ESTATE (SPL) DIVN.	TECH. UNIT-II ESTATE	D001FL13	GREATWAY	NON AMR	OK	31.03.2023	Category 2			12479414	1200/577/1-1-1	11.530	NA	Director/D
B.2789	Central	CITY WEST LU DHIANA	11KV	DS ESTATE (SPL) DIVN.	TECH. UNIT-II ESTATE	D001FL20	GIASPURA	AMR	OK	31.03.2023	Category 1			12479412	1200/577/1-1-1	11.916	NA	Director/D
B.2790	Central	CITY WEST LU DHIANA	11KV	DS ESTATE (SPL) DIVN.	TECH. UNIT-II ESTATE	D001FL38	M.C.LL	AMR	OK	31.03.2023	Category 1			34224	1200/577/1-1-1	11.983	NA	Director/D
B.2791	Central	CITY WEST LU DHIANA	11KV	DS ESTATE (SPL) DIVN.	TECH. UNIT-II ESTATE	D001FL37	GAGAN NAGAR	AMR	OK	31.03.2023	Category 1			33763	1200/577/1-1-1	12.197	NA	Director/D
B.2792	Central	CITY WEST LU DHIANA	11KV	DS ESTATE (SPL) DIVN.	TECH. UNIT-II ESTATE	D001FL41	SANGITA TOOLS	AMR	OK	31.03.2023	Category 2			2574	1200/577/1-1-1	14.069	NA	Director/D
B.2793	Central	CITY WEST LU DHIANA	11KV	DS ESTATE (SPL) DIVN.	TECH. UNIT-II ESTATE	D001FL39	LOHARA ROAD	AMR	OK	31.03.2023	Category 1			23235	1200/577/1-1-1	14.839	NA	Director/D
B.2794	Central	CITY WEST LU DHIANA	11KV	DS ESTATE (SPL) DIVN.	TECH. UNIT-II ESTATE	D001FL34	AS CASTING	AMR	OK	31.03.2023	Category 2			12479320	1200/577/1-1-1	16.637	NA	Director/D
B.2795	Central	CITY WEST LU DHIANA	11KV	DS ESTATE (SPL) DIVN.	TECH. UNIT-II ESTATE	D001FL18	DANG STEEL	AMR	OK	31.03.2023	Category 2			12479415	1200/577/1-1-1	19.146	NA	Director/D
B.2796	Central	CITY WEST LU DHIANA	11KV	DS ESTATE (SPL) DIVN.	TECH. UNIT-II ESTATE	D001FL21	GOBIND RUBBER-2	AMR	OK	31.03.2023	Category 4			9141129	1200/577/1-1-1	0.000	NA	Director/D
B.2797	Central	CITY WEST LU DHIANA	11KV	DS ESTATE (SPL) DIVN.	TECH. UNIT-II ESTATE	D002FL31	K.N.K ALLOY	AMR	OK	31.03.2023	Category 2			12527367	1200/577/1-1-1	0.000	NA	Director/D
B.2798	Central	CITY WEST LU DHIANA	11KV	DS ESTATE (SPL) DIVN.	TECH. UNIT-II ESTATE	D002FL32	N.S.ALLOY	AMR	OK	31.03.2023	Category 2			7349821	1200/577/1-1-1	0.000	NA	Director/D
B.2799	Central	CITY WEST LU DHIANA	11KV	DS ESTATE (SPL) DIVN.	TECH. UNIT-II ESTATE	D002FL49	Pawa Road	AMR	OK	31.03.2023	Category 2			11056	1200/577/1-1-1	0.380	NA	Director/D
B.2800	Central	CITY WEST LU DHIANA	11KV	DS ESTATE (SPL) DIVN.	TECH. UNIT-II ESTATE	D002FL11	HINDUSTAN	AMR	OK	31.03.2023	Category 4			9154258	1200/577/1-1-1	0.974	NA	Director/D
B.2801	Central	CITY WEST LU DHIANA	11KV	DS ESTATE (SPL) DIVN.	TECH. UNIT-II ESTATE	D002FL13	SUDERSHAN	AMR	OK	31.03.2023	Category 2			2067812	1200/577/1-1-1	1.472	NA	Director/D
B.2802	Central	CITY WEST LU DHIANA	11KV	DS ESTATE (SPL) DIVN.	TECH. UNIT-II ESTATE	D002FL48	Tenua Road	AMR	OK	31.03.2023	Category 2			46999	1200/577/1-1-1	1.707	NA	Director/D
B.2803	Central	CITY WEST LU DHIANA	11KV	DS ESTATE (SPL) DIVN.	TECH. UNIT-II ESTATE	D002FL37	V.Y. CONCAST	AMR	OK	31.03.2023	Category 2			12479789	1200/577/1-1-1	2.054	NA	Director/D
B.2804	Central	CITY WEST LU DHIANA	11KV	DS ESTATE (SPL) DIVN.	TECH. UNIT-II ESTATE	D002FL43	GoBind Rubber-2 New	AMR	OK	31.03.2023	Category 2			2710	1200/577/1-1-1	2.359	NA	Director/D
B.2805	Central	CITY WEST LU DHIANA	11KV	DS ESTATE (SPL) DIVN.	TECH. UNIT-II ESTATE	D002FL10	GARG FURNACE	NON AMR	OK	31.03.2023	Category 2			6761951	1200/577/1-1-1	3.117	NA	Director/D
B.2806	Central	CITY WEST LU DHIANA	11KV	DS ESTATE (SPL) DIVN.	TECH. UNIT-II ESTATE	D002FL46	Shv Kripa	NON AMR	OK	31.03.2023	Category 2			73182482	1200/577/1-1-1	3.589	NA	Director/D
B.2807	Central	CITY WEST LU DHIANA	11KV	DS ESTATE (SPL) DIVN.	TECH. UNIT-II ESTATE	D002FL24	DEMARTE	AMR	OK	31.03.2023	Category 2			9534390	1200/577/1-1-1	3.608	NA	Director/D
B.2808	Central	CITY WEST LU DHIANA	11KV	DS ESTATE (SPL) DIVN.	TECH. UNIT-II ESTATE	D002FL47	LSR Forge	AMR	OK	31.03.2023	Category 2			65543	1200/577/1-1-1	5.119	NA	Director/D
B.2809	Central	CITY WEST LU DHIANA	11KV	DS ESTATE (SPL) DIVN.	TECH. UNIT-II ESTATE	D002FL44	GoBind Rubber 1 New	AMR	OK	31.03.2023	Category 2			4824	1200/577/1-1-1	5.569	NA	Director/D
B.2810	Central	CITY WEST LU DHIANA	11KV	DS ESTATE (SPL) DIVN.	TECH. UNIT-II ESTATE	D002FL27	SUA ROAD	AMR	OK	31.03.2023	Category 2			10281216	1200/577/1-1-1	6.031	NA	Director/D
B.2811	Central	CITY WEST LU DHIANA	11KV	DS ESTATE (SPL) DIVN.	TECH. UNIT-II ESTATE	D002FL02	GARG	NON AMR	OK	31.03.2023	Category 2			5295591	1200/577/1-1-1	6.698	NA	Director/D
B.2812	Central	CITY WEST LU DHIANA	11KV	DS ESTATE (SPL) DIVN.	TECH. UNIT-II ESTATE	D002FL17	TURBO	AMR	OK	31.03.2023	Category 2			7039590	1200/577/1-1-1	7.512	NA	Director/D
B.2813	Central	CITY WEST LU DHIANA	11KV	DS ESTATE (SPL) DIVN.	TECH. UNIT-II ESTATE	D002FL01	OSVAL ALLOY	AMR	OK	31.03.2023	Category 2			704967	1200/577/1-1-1	7.579	NA	Director/D
B.2814	Central	CITY WEST LU DHIANA	11KV	DS ESTATE (SPL) DIVN.	TECH. UNIT-II ESTATE	D002FL45	RAM CASTING	NON AMR	OK	31.03.2023	Category 2			2045401	1200/577/1-1-1	7.696	NA	Director/D
B.2815	Central	CITY WEST LU DHIANA	11KV	DS ESTATE (SPL) DIVN.	TECH. UNIT-II ESTATE	D002FL23	HINDUSTAN TYRE	NON AMR	OK	31.03.2023	Category 4			5342497	1200/577/1-1-1	8.025	NA	Director/D
B.2816	Central	CITY WEST LU DHIANA	11KV	DS ESTATE (SPL) DIVN.	TECH. UNIT-II ESTATE	D002FL08	THAPSON	AMR	OK	31.03.2023	Category 2			10281216	1200/577/1-1-1	8.816	NA	Director/D
B.2817	Central	CITY WEST LU DHIANA	11KV	DS ESTATE (SPL) DIVN.	TECH. UNIT-II ESTATE	D002FL28	SUDHIR FORGING	AMR	OK	31.03.2023	Category 2			10282838	1200/577/1-1-1	9.000	NA	Director/D
B.2818	Central	CITY WEST LU DHIANA	11KV	DS ESTATE (SPL) DIVN.	TECH. UNIT-II ESTATE	D002FL05	METRO AZAD	AMR	OK	31.03.2023	Category 4			5295700	1200/577/1-1-1	9.247	NA	Director/D
B.2819	Central	CITY WEST LU DHIANA	11KV	DS ESTATE (SPL) DIVN.	TECH. UNIT-II ESTATE	D002FL03	GOBIND RUBBER	NON AMR	OK	31.03.2023	Category 4			1314529	1200/577/1-1-1	9.390	NA	Director/D
B.2820	Central	CITY WEST LU DHIANA	11KV	DS ESTATE (SPL) DIVN.	TECH. UNIT-II ESTATE	D002FL25	MANSHOVER	AMR	OK	31.03.2023	Category 2			2045401	1200/577/1-1-1	10.395	NA	Director/D
B.2821	Central	CITY WEST LU DHIANA	11KV	DS ESTATE (SPL) DIVN.	TECH. UNIT-II ESTATE	D002FL16	ANAND MANGAL	AMR	OK	31.03.2023	Category 2			10273751	1200/577/1-1-1	10.684	NA	Director/D
B.2822	Central	CITY WEST LU DHIANA	11KV	DS ESTATE (SPL) DIVN.	TECH. UNIT-II ESTATE	D002FL39	PROMINENT	AMR	OK	31.03.2023	Category 2			4093	1200/577/1-1-1	11.236	NA	Director/D
B.2823	Central	CITY WEST LU DHIANA	11KV	DS ESTATE (SPL) DIVN.	TECH. UNIT-II ESTATE	D002FL07	A.S. ALLOY	NON AMR	OK	31.03.2023	Category 2			703084	1200/577/1-1-1	11.674	NA	Director/D
B.2824	Central	CITY WEST LU DHIANA	11KV	DS ESTATE (SPL) DIVN.	TECH. UNIT-II ESTATE	D002FL33	MAHADEV FORGING	AMR	OK	31.03.2023	Category 2			2046465	1200/577/1-1-1	11.815	NA	Director/D
B.2825	Central	CITY WEST LU DHIANA	11KV	DS ESTATE (SPL) DIVN.	TECH. UNIT-II ESTATE	D002FL20	JAMAL COTTON	AMR	OK	31.03.2023	Category 4			9341131	1200/577/1-1-1	12.874	NA	Director/D
B.2826	Central	CITY WEST LU DHIANA	11KV	DS ESTATE (SPL) DIVN.	TECH. UNIT-II ESTATE	D002FL06	VISHKARMA	AMR	OK	31.03.2023	Category 2			2046969	1200/577/1-1-1	12.739	NA	Director/D
B.2827	Central	CITY WEST LU DHIANA	11KV	DS ESTATE (SPL) DIVN.	TECH. UNIT-II ESTATE	D002FL14	AMAR UDYOG	AMR	OK	31.03.2023	Category 2			73182482	1200/577/1-1-1	12.930	NA	Director/D
B.2828	Central	CITY WEST LU DHIANA	11KV	DS ESTATE (SPL) DIVN.	TECH. UNIT-II ESTATE	D002FL36	JASPAL BANGER RD	NON AMR	OK	31.03.2023	Category 2			12479596	1200/577/1-1-1	13.050	NA	Director/D
B.2829	Central	CITY WEST LU DHIANA	11KV	DS ESTATE (SPL) DIVN.	TECH. UNIT-II ESTATE	D002FL26	SINGLA COLONY	AMR	OK	31.03.2023	Category 2			5295715	1200/577/1-1-1	13.201	NA	Director/D
B.2830	Central	CITY WEST LU DHIANA	11KV	DS ESTATE (SPL) DIVN.	TECH. UNIT-II ESTATE	D002FL19	SHIVARIA	NON AMR	OK	31.03.2023	Category 4			10282123	1200/577/1-1-1	13.297	NA	Director/D
B.2831	Central	CITY WEST LU DHIANA	11KV	DS ESTATE (SPL) DIVN.	TECH. UNIT-II ESTATE	D002FL04	KANGANWAL	AMR	OK	31.03.2023	Category 2			30326	1200/577/1-1-1	13.955	NA	Director/D
B.2832	Central	CITY WEST LU DHIANA	11KV	DS ESTATE (SPL) DIVN.	TECH. UNIT-II ESTATE	D002FL38	KABIR EMPAK	AMR	OK	31.03.2023	Category 2			2691	1200/577/1-1-1	14.695	NA	Director/D
B.2833	Central	CITY WEST LU DHIANA	11KV	DS ESTATE (SPL) DIVN.	TECH. UNIT-II ESTATE	D002FL34	DURGA CONCAST	NON AMR	OK	31.03.2023	Category 2			73182482	1200/577/1-1-1	14.771	NA	Director/D
B.2834	Central	CITY WEST LU DHIANA	11KV	DS ESTATE (SPL) DIVN.	TECH. UNIT-II ESTATE	D002FL29	VAIDYA ALLOY	AMR	OK	31.03.2023	Category 2			30336	1200/577/1-1-1	14.975	NA	Director/D
B.2835	Central	CITY WEST LU DHIANA	11KV	DS ESTATE (SPL) DIVN.	TECH. UNIT-II ESTATE	D002FL35	RIITEX	NON AMR	OK	31.03.2023	Category 2			30339	1200/577/1-1-1	15.272	NA	Director/D
B.2836	Central	CITY WEST LU DHIANA	11KV	DS ESTATE (SPL) DIVN.	TECH. UNIT-II ESTATE	D002FL21	AMRIT RUBBER	AMR	OK	31.03.2023	Category 2			5342497	1200/577/1-1-1	15.348	NA	Director/D
B.2837	Central	CITY WEST LU DHIANA	11KV	DS ESTATE (SPL) DIVN.	TECH. UNIT-II ESTATE	D002FL30	PANAMA ALLOYS	AMR	OK	31.03.2023	Category 2			12479834	1200/577/1-1-1	26.810	NA	Director/D
B.2838	Central	CITY WEST LU DHIANA	11KV	DS ESTATE (SPL) DIVN.	TECH. UNIT-II ESTATE	D002FL10	Garcha	AMR	OK	31.03.2023	Category 1			36687	1200/577/1-1-1	0.003	NA	Director/D
B.2839	Central	CITY WEST LU DHIANA	11KV	DS ESTATE (SPL) DIVN.	TECH. UNIT-II ESTATE	D002FL11	EveLine (new)	AMR	OK	31.03.2023	Category 4			4112	1200/577/1-1-1	3.214	NA	Director/D
B.2840	Central	CITY WEST LU DHIANA	11KV	DS ESTATE (SPL) DIVN.	TECH. UNIT-II ESTATE	D002FL06	AMRIT FASTNER	AMR	OK	31.03.2023	Category 2			36687	1200/577/1-1-1	5.443	NA	Director/D
B.2841	Central	CITY WEST LU DHIANA	11KV	DS ESTATE (SPL) DIVN.	TECH. UNIT-II ESTATE	D002FL12	ROHIT	AMR	OK	31.03.2023	Category 2			4025	1200/577/1-1-1	6.527	NA	Director/D
B.2842	Central	CITY WEST LU DHIANA	11KV	DS ESTATE (SPL) DIVN.	TECH. UNIT-II ESTATE	D002FL08	SARTAJ	AMR	OK	31.03.2023	Category 2			4025	1200/577/1-1-1	6.610	NA	Director/D
B.2843	Central	CITY WEST LU DHIANA	11KV	DS ESTATE (SPL) DIVN.	TECH. UNIT-II ESTATE	FL13D032	EKTA MARKET	AMR	OK	31.03.2023	Category 2			1346	1200/577/1-1-1	6.629	NA	Director/D
B.2844	Central	CITY WEST LU DHIANA	11KV	DS ESTATE (SPL) DIVN.	TECH. UNIT-II ESTATE	D002FL03	Jindie Cycle	AMR	OK	31.03.2023	Category 2			36929	1200/577/1-1-1	6.818	NA	Director/D
B.2845	Central	CITY WEST LU DHIANA	11KV	DS ESTATE (SPL) DIVN.	TECH. UNIT-II ESTATE	D002FL07	Dhilon	AMR	OK	31.03.2023	Category 2			36678	1200/577/1-1-1	7.738	NA	Director/D
B.2846	Central	CITY WEST LU DHIANA	11KV	DS ESTATE (SPL) DIVN.	TECH. UNIT-II ESTATE	D002FL02	Bhushan	AMR	OK	31.03.2023	Category 2			36680	1200/577/1-1-1	8.822	NA	Director/D
B.2847	Central	CITY WEST LU DHIANA	11KV	DS ESTATE (SPL) DIVN.	TECH. UNIT-II ESTATE	D002FL05	GOLDENBA	AMR	OK	31.03.2023	Category 2			36554	1200/577/1-1-1	8.915	NA	Director/D
B.2848	Central	CITY WEST LU DHIANA	11KV	DS ESTATE (SPL) DIVN.	TECH. UNIT-II ESTATE	D002FL04	MAHADEV FORGING	AMR	OK	31.03.2023	Category 2			36657				

S.No	Zone	Circle	Voltage Level (kVA)	Division (kVA)	Sub-Division (kVA)	Feeder ID	Feeder Name	Feeder Metering Status (Metred/unmetred/AMR/AM)	Status of Meter (Functional/Non-Functional)	Metering Date (Date of last actual meter reading/communication)	Feeder Type (Agr/Industrial/Mixed)	Status of Communication			Period from 01.04.2021 to 31.03.2022			Sales	Remarks (Source of data)
												% data received through automatically if feeder AMR/AM	Number of hours when meter was unable to communicate in overall	Total Number of hours in the period	Meter S.No	CT/PT ratio	Import (kU)		
B.2880	Central	CITY WEST LUDHIANA	11KV	DS J. NGR (SP) DIVN.	TECH UNIT-II J.NAGAR	0005F08	SANGETT FEEDER	AMR	OK	31.03.2023	Category 1				12479303	1200/577/1-1-1	7.508	NA	Director/D
B.2881	Central	CITY WEST LUDHIANA	11KV	DS J. NGR (SP) DIVN.	TECH UNIT-II J.NAGAR	0005F121	M.I.G. FLATS	AMR	OK	31.03.2023	Category 1				33779	1200/577/1-1-1	7.797	NA	Director/D
B.2882	Central	CITY WEST LUDHIANA	11KV	DS J. NGR (SP) DIVN.	TECH UNIT-II J.NAGAR	0005F122	SAS NAGAR	NON AMR	OK	31.03.2023	Category 1				73150692	1200/577/1-1-1	8.712	NA	Director/D
B.2883	Central	CITY WEST LUDHIANA	11KV	DS J. NGR (SP) DIVN.	TECH UNIT-II J.NAGAR	0005F106	METRO FEEDER	NON AMR	OK	31.03.2023	Category 2				12479305	1200/577/1-1-1	9.101	NA	Director/D
B.2884	Central	CITY WEST LUDHIANA	11KV	DS J. NGR (SP) DIVN.	TECH UNIT-II J.NAGAR	0005F117	POPULAR FEEDER	NON AMR	OK	31.03.2023	Category 1				12479306	1200/577/1-1-1	9.142	NA	Director/D
B.2885	Central	CITY WEST LUDHIANA	11KV	DS J. NGR (SP) DIVN.	TECH UNIT-II J.NAGAR	0006F116	MICROWAVE FEEDER	AMR	OK	31.03.2023	Category 4				12479482	1200/577/1-1-1	0.256	NA	Director/D
B.2886	Central	CITY WEST LUDHIANA	11KV	DS J. NGR (SP) DIVN.	TECH UNIT-II J.NAGAR	0006F137	MANDI BOARD	NON AMR	OK	31.03.2023	Category 1				525508	1200/577/1-1-1	1.414	NA	Director/D
B.2887	Central	CITY WEST LUDHIANA	11KV	DS J. NGR (SP) DIVN.	TECH UNIT-II J.NAGAR	0006F106	GILL ROAD FEEDER	AMR	OK	31.03.2023	Category 1				12479330	1200/577/1-1-1	4.423	NA	Director/D
B.2888	Central	CITY WEST LUDHIANA	11KV	DS J. NGR (SP) DIVN.	TECH UNIT-II J.NAGAR	0006F105	ESTATE FEEDER	AMR	OK	31.03.2023	Category 1				6740822	1200/577/1-1-1	5.406	NA	Director/D
B.2889	Central	CITY WEST LUDHIANA	11KV	DS J. NGR (SP) DIVN.	TECH UNIT-II J.NAGAR	0006F132	RAHMA SWAMI ROAD	NON AMR	OK	31.03.2023	Category 1				583783	1200/577/1-1-1	7.524	NA	Director/D
B.2890	Central	CITY WEST LUDHIANA	11KV	DS J. NGR (SP) DIVN.	TECH UNIT-II J.NAGAR	0006F120	CHET SINGH NAGAR	AMR	OK	31.03.2023	Category 1				12479669	1200/577/1-1-1	8.173	NA	Director/D
B.2891	Central	CITY WEST LUDHIANA	11KV	DS J. NGR (SP) DIVN.	TECH UNIT-II J.NAGAR	0006F128	HEKRRISHAN NAGAR FEEDER	NON AMR	OK	31.03.2023	Category 1				583727	900-450/577/1-1-1	8.883	NA	Director/D
B.2892	Central	CITY WEST LUDHIANA	11KV	DS J. NGR (SP) DIVN.	TECH UNIT-III J.NAGAR	0006F108	MERADO FEEDER	NON AMR	OK	31.03.2023	Category 4				12479668	1200/577/1-1-1	2.325	NA	Director/D
B.2893	Central	CITY WEST LUDHIANA	11KV	DS J. NGR (SP) DIVN.	TECH UNIT-III J.NAGAR	0006F112	DABA ROAD FEEDER	AMR	OK	31.03.2023	Category 1				12479667	1200/577/1-1-1	4.759	NA	Director/D
B.2894	Central	CITY WEST LUDHIANA	11KV	DS J. NGR (SP) DIVN.	TECH UNIT-III J.NAGAR	0006F138	SATSANG GHAR	NON AMR	OK	31.03.2023	Category 1				123231	1200/577/1-1-1	6.990	NA	Director/D
B.2895	Central	CITY WEST LUDHIANA	11KV	DS J. NGR (SP) DIVN.	TECH UNIT-III J.NAGAR	0006F124	KARNAL SINGH NAGAR FEEDER	NON AMR	OK	31.03.2023	Category 1				12479570	1200/577/1-1-1	8.609	NA	Director/D
B.2896	Central	CITY WEST LUDHIANA	11KV	DS J. NGR (SP) DIVN.	TECH UNIT-III J.NAGAR	0006F101	PREET NAGAR FEEDER	NON AMR	OK	31.03.2023	Category 1				12479331	1200/577/1-1-1	8.652	NA	Director/D
B.2897	Central	CITY WEST LUDHIANA	11KV	DS J. NGR (SP) DIVN.	TECH UNIT-III J.NAGAR	0006F119	GURU NANAK STREET FEEDER	AMR	OK	31.03.2023	Category 1				12479671	1200/577/1-1-1	10.581	NA	Director/D
B.2898	Central	CITY WEST LUDHIANA	11KV	DS J. NGR (SP) DIVN.	TECH UNIT-III J.NAGAR	0006F107	SHILMA PURI FEEDER	AMR	OK	31.03.2023	Category 1				12479327	900-450/577/1-1-1	11.526	NA	Director/D
B.2899	Central	CITY WEST LUDHIANA	11KV	DS J. NGR (SP) DIVN.	TECH UNIT-III J.NAGAR	0006F122	GOBIND NAGAR FEEDER	AMR	OK	31.03.2023	Category 1				12939784	1200/577/1-1-1	12.545	NA	Director/D
B.2900	Central	CITY WEST LUDHIANA	11KV	DS J. NGR (SP) DIVN.	TECH UNIT-III J.NAGAR	0006F134	SATGURU FEEDER	AMR	OK	31.03.2023	Category 1				16194428	1200/577/1-1-1	13.449	NA	Director/D
B.2901	Central	CITY WEST LUDHIANA	11KV	DS J. NGR (SP) DIVN.	TECH UNIT-III J.NAGAR	0006F121	AZAD NAGAR FEEDER	AMR	OK	31.03.2023	Category 1				10283012	1200/577/1-1-1	17.850	NA	Director/D
B.2902	Central	CITY WEST LUDHIANA	11KV	DS J. NGR (SP) DIVN.	TECH UNIT-III J.NAGAR	0006F110	ISHER NAGAR FEEDER	AMR	OK	31.03.2023	Category 1				55566	1200/577/1-1-1	18.325	NA	Director/D
B.2903	Central	CITY WEST LUDHIANA	11KV	DS J. NGR (SP) DIVN.	TECH UNIT-III J.NAGAR	0006F126	LOHARA	AMR	OK	31.03.2023	Category 1				10282831	1200/577/1-1-1	20.194	NA	Director/D
B.2904	Central	CITY WEST LUDHIANA	11KV	DS J. NGR (SP) DIVN.	TECH UNIT-III J.NAGAR	0006F125	BAROTA ROAD	AMR	OK	31.03.2023	Category 1				33689	900-450/577/1-1-1	21.373	NA	Director/D
B.2905	Central	CITY WEST LUDHIANA	11KV	DS MODEL TOWN (SP)	TECH -II M. TOWN (SP)	0020F107	SEALAR	AMR	OK	31.03.2023	Category 1				2067324	1200/577/1-1-1	1.316	NA	Director/D
B.2906	Central	CITY WEST LUDHIANA	11KV	DS MODEL TOWN (SP)	TECH -II M. TOWN (SP)	0020F109	RAILWAY LOCO SHED	AMR	OK	31.03.2023	Category 2				2067897	1200/577/1-1-1	4.036	NA	Director/D
B.2907	Central	CITY WEST LUDHIANA	11KV	DS MODEL TOWN (SP)	TECH -II M. TOWN (SP)	0020F104	GULMOHAR	AMR	OK	31.03.2023	Category 1				2068526	1200/577/1-1-1	11.183	NA	Director/D
B.2908	Central	CITY WEST LUDHIANA	11KV	DS MODEL TOWN (SP)	TECH -II M. TOWN (SP)	0020F101	SITA NAGAR	AMR	OK	31.03.2023	Category 1				6740711	1200/577/1-1-1	13.378	NA	Director/D
B.2909	Central	CITY WEST LUDHIANA	11KV	DS MODEL TOWN (SP)	TECH -II M. TOWN (SP)	0020F105	MODEL GRAM	AMR	OK	31.03.2023	Category 1				2067084	1200/577/1-1-1	15.633	NA	Director/D
B.2910	Central	CITY WEST LUDHIANA	11KV	DS MODEL TOWN (SP)	TECH -II M. TOWN (SP)	0006F104	BISEEL SHED	AMR	OK	31.03.2023	Category 2				12479670	900-450/577/1-1-1	0.000	NA	Director/D
B.2911	Central	CITY WEST LUDHIANA	11KV	DS MODEL TOWN (SP)	TECH -II M. TOWN (SP)	0020F126	B-BLOCK	AMR	OK	31.03.2023	Category 1				23313	1200/577/1-1-1	2.834	NA	Director/D
B.2912	Central	CITY WEST LUDHIANA	11KV	DS MODEL TOWN (SP)	TECH -II M. TOWN (SP)	0013F116	Sidhwan Hydro	AMR	OK	31.03.2023	Category 2				15196587	1200/577/1-1-1	0.018	NA	Director/D
B.2913	Central	CITY WEST LUDHIANA	11KV	DS MODEL TOWN (SP)	TECH -II M. TOWN (SP)	0013F118	A-BLOCK	AMR	OK	31.03.2023	Category 1				33768	1200/577/1-1-1	4.658	NA	Director/D
B.2914	Central	CITY WEST LUDHIANA	11KV	DS MODEL TOWN (SP)	TECH -II M. TOWN (SP)	0013F123	TIKONA PARK	AMR	OK	31.03.2023	Category 1				33755	1200/577/1-1-1	5.077	NA	Director/D
B.2915	Central	CITY WEST LUDHIANA	11KV	DS MODEL TOWN (SP)	TECH -II M. TOWN (SP)	0013F121	BANK COLONY	AMR	OK	31.03.2023	Category 1				33744	1200/577/1-1-1	5.548	NA	Director/D
B.2916	Central	CITY WEST LUDHIANA	11KV	DS MODEL TOWN (SP)	TECH -II M. TOWN (SP)	0013F114	MANIT NAGAR	AMR	OK	31.03.2023	Category 1				33736	1200/577/1-1-1	6.946	NA	Director/D
B.2917	Central	CITY WEST LUDHIANA	11KV	DS MODEL TOWN (SP)	TECH -II M. TOWN (SP)	0013F122	CHILDREN PARK	NON AMR	OK	31.03.2023	Category 1				33745	1200/577/1-1-1	7.319	NA	Director/D
B.2918	Central	CITY WEST LUDHIANA	11KV	DS MODEL TOWN (SP)	TECH -II M. TOWN (SP)	0013F106	BUS STAND	NON AMR	OK	31.03.2023	Category 1				12479258	1200/577/1-1-1	7.702	NA	Director/D
B.2919	Central	CITY WEST LUDHIANA	11KV	DS MODEL TOWN (SP)	TECH -II M. TOWN (SP)	0013F103	EXTENSION	AMR	OK	31.03.2023	Category 1				12479743	1200/577/1-1-1	7.708	NA	Director/D
B.2920	Central	CITY WEST LUDHIANA	11KV	DS MODEL TOWN (SP)	TECH -II M. TOWN (SP)	0013F120	DHURI LINE	NON AMR	OK	31.03.2023	Category 1				33750	1200/577/1-1-1	8.147	NA	Director/D
B.2921	Central	CITY WEST LUDHIANA	11KV	DS MODEL TOWN (SP)	TECH -II M. TOWN (SP)	0013F115	C.T.B.	NON AMR	OK	31.03.2023	Category 1				12479742	1200/577/1-1-1	8.425	NA	Director/D
B.2922	Central	CITY WEST LUDHIANA	11KV	DS MODEL TOWN (SP)	TECH -II M. TOWN (SP)	0013F107	MODEL HOUSE	NON AMR	OK	31.03.2023	Category 1				12479704	1200/577/1-1-1	1.543	NA	Director/D
B.2923	Central	CITY WEST LUDHIANA	11KV	DS MODEL TOWN (SP)	TECH -II M. TOWN (SP)	0013F108	ABDULLAPUR BASTI	NON AMR	OK	31.03.2023	Category 1				12479716	1200/577/1-1-1	9.875	NA	Director/D
B.2924	Central	CITY WEST LUDHIANA	11KV	DS MODEL TOWN (SP)	TECH -II M. TOWN (SP)	0013F102	JAMMU COLONY	NON AMR	OK	31.03.2023	Category 1				12479275	1200/577/1-1-1	8.544	NA	Director/D
B.2925	Central	CITY WEST LUDHIANA	11KV	DS MODEL TOWN (SP)	TECH -II M. TOWN (SP)	0013F109	MODEL TOWN	NON AMR	OK	31.03.2023	Category 1				12479745	1200/577/1-1-1	9.584	NA	Director/D
B.2926	Central	CITY WEST LUDHIANA	11KV	DS MODEL TOWN (SP)	TECH -II M. TOWN (SP)	0013F104	ATAM NAGAR	AMR	OK	31.03.2023	Category 1				12479702	1200/577/1-1-1	11.022	NA	Director/D
B.2927	Central	CITY WEST LUDHIANA	11KV	DS MODEL TOWN (SP)	TECH -II M. TOWN (SP)	0013F113	RIJALAR	NON AMR	OK	31.03.2023	Category 1				12479755	1200/577/1-1-1	11.505	NA	Director/D
B.2928	Central	CITY WEST LUDHIANA	11KV	DS MODEL TOWN (SP)	TECH -II M. TOWN (SP)	0013F112	MINI GUMRI	AMR	OK	31.03.2023	Category 1				12479705	1200/577/1-1-1	11.979	NA	Director/D
B.2929	Central	CITY WEST LUDHIANA	11KV	DS MODEL TOWN (SP)	TECH UNIT-1 M. TOWN	0002F109	S.B.S. Ngr.	AMR	OK	31.03.2023	Category 1				7042857	1200/577/1-1-1	0.213	NA	Director/D
B.2930	Central	CITY WEST LUDHIANA	11KV	DS MODEL TOWN (SP)	TECH UNIT-1 M. TOWN	0034F104	THAKARWAL ROAD	AMR	OK	31.03.2023	AP 3Phase 3Wires				33748	1200-600/5	1.636	NA	Director/D
B.2931	Central	CITY WEST LUDHIANA	11KV	DS MODEL TOWN (SP)	TECH UNIT-1 M. TOWN	0034F105	DANA MANDI	AMR	OK	31.03.2023	Category 5-UIPS				1953	1200-600/5	5.687	NA	Director/D
B.2932	Central	CITY WEST LUDHIANA	11KV	DS MODEL TOWN (SP)	TECH UNIT-1 M. TOWN	0034F102	ADARSI	AMR	OK	31.03.2023	Category 1				33730	1200-600/5	10.593	NA	Director/D
B.2933	Central	CITY WEST LUDHIANA	11KV	DS MODEL TOWN (SP)	TECH UNIT-1 M. TOWN	0034F103	RAJATI BAGG	NON AMR	OK	31.03.2023	Category 1				33749	1200-600/5	10.872	NA	Director/D
B.2934	Central	CITY WEST LUDHIANA	11KV	DS MODEL TOWN (SP)	TECH UNIT-1 M. TOWN	0006F102	NIRMAL NAGAR	NON AMR	OK	31.03.2023	Category 1				12479558	1200/577/1-1-1	0.000	NA	Director/D
B.2935	Central	CITY WEST LUDHIANA	11KV	DS MODEL TOWN (SP)	TECH UNIT-1 M. TOWN	0013F110	DUGRI	NON AMR	OK	31.03.2023	Category 1				12479744	1200/577/1-1-1	7.082	NA	Director/D
B.2936	Central	CITY WEST LUDHIANA	11KV	DS MODEL TOWN (SP)	TECH UNIT-1 M. TOWN	0013F101	URBAN ESTATE PH-1	AMR	OK	31.03.2023	Category 1				12479260	1200/577/1-1-1	7.622	NA	Director/D
B.2937	Central	CITY WEST LUDHIANA	11KV	DS MODEL TOWN (SP)	TECH UNIT-1 M. TOWN	0013F119	URBAN VILLAGE	AMR	OK	31.03.2023	Category 1				33747	1200/577/1-1-1	7.859	NA	Director/D
B.2938	Central	CITY WEST LUDHIANA	11KV	DS MODEL TOWN (SP)	TECH UNIT-1 M. TOWN	0013F117	URBAN VILLAGE	NON AMR	OK	31.03.2023	Category 1				12479741	1200/577/1-1-1	8.496	NA	Director/D
B.2939	Central	CITY WEST LUDHIANA	11KV	DS MODEL TOWN (SP)	TECH UNIT-1 M. TOWN	0013F114	GURJI GHAN VIHAR	NON AMR	OK	31.03.2023	Category 1				12479746	1200/577/1-1-1	11.039	NA	Director/D
B.2940	Central	CITY WEST LUDHIANA	11KV	DS MODEL TOWN (SP)	TECH UNIT-1 M. TOWN	0013F105	VISHAL NAGAR	NON AMR	OK	31.03.2023	Category 1				12479261	1200/577/1-1-1	11.356	NA	Director/D
B.2941	Central	CITY WEST LUDHIANA	11KV	DS MODEL TOWN (SP)	TECH UNIT-1 M. TOWN	0013F111	RENTAL COLONY	AMR	OK	31.03.2023	Category 1				12479259	1200/577/1-1-1	12.306	NA	Director/D
B.2942	Central	CITY WEST LUDHIANA	11KV	DS MODEL TOWN (SP)	TECH UNIT-1 M														

S.No	Zone	Circle	Voltage Level (kVA)	Division (kVA)	Sub-Division (kVA)	Feeder ID	Feeder Name	Feeder Metering Status (Metered/unmetered/AMR/AM)	Status of Meter (Functional/Non-Functional)	Metering Date (Date of last actual meter reading/communication)	Feeder Type (Agr/Industrial/Mixed)	Status of Communication			Period from 01.04.2021 to 31.03.2022				Sales	Remarks (Source of data)
												% data received through automatically by feeder AMR/AM	Number of hours when meter was unable to communicate in overall	Total Number of hours in the period	Meter S.No	CT/PT ratio	Import (kU)	Export (kU)		
B.2977	Central	KHANNA	11KV	D5 (S/PL/DVN/M/GOBINT+H) (DSISPL S/Div M/GOBND GARH	B110FL02	DIAMOND (P.5 Alloy-)	AMR	OK	31.03.2023	Category 2				7035632	1200-600/5	18.777	NA	Director/D		
B.2978	Central	KHANNA	11KV	D5 (S/PL/DVN/M/GOBINT+H) (DSISPL S/Div M/GOBND GARH	D110FL23	P.P	AMR	OK	31.03.2023	Category 3				2065894	1200-600/5	19.204	NA	Director/D		
B.2979	Central	KHANNA	11KV	D5 (S/PL/DVN/M/GOBINT+H) (DSISPL S/Div M/GOBND GARH	B110FL14	Ram J Concast	AMR	OK	31.03.2023	Category 3				365487	1200-600/5	20.390	NA	Director/D		
B.2980	Central	KHANNA	11KV	D5 (S/PL/DVN/M/GOBINT+H) (DSISPL S/Div M/GOBND GARH	D110FL32	Dhivresh (SHIVA)	AMR	OK	31.03.2023	Category 3				2064633	1200-600/5	20.593	NA	Director/D		
B.2981	Central	KHANNA	11KV	D5 (S/PL/DVN/M/GOBINT+H) (DSISPL S/Div M/GOBND GARH	D110FL22	Hind	NON AMR	OK	31.03.2023	Category 3				7039558	1200-600/5	25.500	NA	Director/D		
B.2982	Central	KHANNA	11KV	D5 (S/PL/DVN/M/GOBINT+H) (DSISPL S/Div M/GOBND GARH	B110FL19	K.S	AMR	OK	31.03.2023	Category 3				123456	1200-600/5	25.887	NA	Director/D		
B.2983	Central	KHANNA	11KV	D5 (S/PL/DVN/M/GOBINT+H) (DSISPL S/Div M/GOBND GARH	D110FL31	C.S CASTING	AMR	OK	31.03.2023	Category 3				6740929	1200-600/5	27.641	NA	Director/D		
B.2984	Central	KHANNA	11KV	D5 (S/PL/DVN/M/GOBINT+H) (DSISPL S/Div M/GOBND GARH	B104FL01	MATHLY STEEL	AMR	OK	31.03.2023	Category 3				125478	1200-600/5	6.222	NA	Director/D		
B.2985	Central	KHANNA	11KV	D5 (S/PL/DVN/M/GOBINT+H) (DSISPL S/Div M/GOBND GARH	B129FL13	R.D FEEDER	AMR	OK	31.03.2023	Category 3				125478	1200-600/5	12.798	NA	Director/D		
B.2986	Central	KHANNA	11KV	D5 (S/PL/DVN/M/GOBINT+H) (DSISPL S/Div M/GOBND GARH	B129FL15	JA THAKUR II	AMR	OK	31.03.2023	Category 3				123547	1200-600/5	17.330	NA	Director/D		
B.2987	Central	KHANNA	11KV	D5 (S/PL/DVN/M/GOBINT+H) (DSISPL S/Div M/GOBND GARH	B129FL14	Akshat alloys	AMR	OK	31.03.2023	Category 3				125478	1200-600/5	18.595	NA	Director/D		
B.2988	Central	KHANNA	11KV	D5 (S/PL/DVN/M/GOBINT+H) (DSISPL S/Div M/GOBND GARH	B029FL12	M.J. STEEL	AMR	OK	31.03.2023	Category 3				125645	1200-600/5	33.511	NA	Director/D		
B.2989	Central	KHANNA	11KV	D5 (S/PL/DVN/M/GOBINT+H) (DSISPL S/Div M/GOBND GARH	B101FL01	Nsit	AMR	OK	31.03.2023	Category 2				8222535	1200-600/5	0.000	NA	Director/D		
B.2990	Central	KHANNA	11KV	D5 (S/PL/DVN/M/GOBINT+H) (DSISPL S/Div M/GOBND GARH	D101FL6	KTEX	AMR	OK	31.03.2023	Category 2				8222580	1200-600/5	0.072	NA	Director/D		
B.2991	Central	KHANNA	11KV	D5 (S/PL/DVN/M/GOBINT+H) (DSISPL S/Div M/GOBND GARH	B101FL37	RUBER CONCAST	AMR	OK	31.03.2023	Category 2				8222552	1200-600/5	0.903	NA	Director/D		
B.2992	Central	KHANNA	11KV	D5 (S/PL/DVN/M/GOBINT+H) (DSISPL S/Div M/GOBND GARH	B101FL25	AMBEY MAIRA	AMR	OK	31.03.2023	Category 1				2067715	1200-600/5	2.018	NA	Director/D		
B.2993	Central	KHANNA	11KV	D5 (S/PL/DVN/M/GOBINT+H) (DSISPL S/Div M/GOBND GARH	B101FL27	ARUN (G1)	NON AMR	OK	31.03.2023	Category 2				9141100	1200-600/5	3.686	NA	Director/D		
B.2994	Central	KHANNA	11KV	D5 (S/PL/DVN/M/GOBINT+H) (DSISPL S/Div M/GOBND GARH	B101FL28	salasar	AMR	OK	31.03.2023	Category 2				91054216	1200-600/5	3.769	NA	Director/D		
B.2995	Central	KHANNA	11KV	D5 (S/PL/DVN/M/GOBINT+H) (DSISPL S/Div M/GOBND GARH	B101FL26	ADARSH	NON AMR	OK	31.03.2023	Category 1				8222416	1200-600/5	4.063	NA	Director/D		
B.2996	Central	KHANNA	11KV	D5 (S/PL/DVN/M/GOBINT+H) (DSISPL S/Div M/GOBND GARH	B101FL8	Roshan	NON AMR	OK	31.03.2023	Category 3				123456	1200-600/5	4.363	NA	Director/D		
B.2997	Central	KHANNA	11KV	D5 (S/PL/DVN/M/GOBINT+H) (DSISPL S/Div M/GOBND GARH	B101FL04	Focal Point	NON AMR	OK	31.03.2023	Category 3				9154245	1200-600/5	6.836	NA	Director/D		
B.2998	Central	KHANNA	11KV	D5 (S/PL/DVN/M/GOBINT+H) (DSISPL S/Div M/GOBND GARH	B101FL36	VARDHMAN	AMR	OK	31.03.2023	Category 2				9154360	1200-600/5	7.557	NA	Director/D		
B.2999	Central	KHANNA	11KV	D5 (S/PL/DVN/M/GOBINT+H) (DSISPL S/Div M/GOBND GARH	B101FL07	Urban	NON AMR	OK	31.03.2023	Category 3				8222409	1200-600/5	9.228	NA	Director/D		
B.3000	Central	KHANNA	11KV	D5 (S/PL/DVN/M/GOBINT+H) (DSISPL S/Div M/GOBND GARH	B101FL24	DURGA	AMR	OK	31.03.2023	Category 3				9154240	1200-600/5	12.505	NA	Director/D		
B.3001	Central	KHANNA	11KV	D5 (S/PL/DVN/M/GOBINT+H) (DSISPL S/Div M/GOBND GARH	B101FL03	C. Road	AMR	OK	31.03.2023	Category 3				8222407	1200-600/5	29.507	NA	Director/D		
B.3002	Central	KHANNA	11KV	D5 (S/PL/DVN/M/GOBINT+H) (DSISPL S/Div M/GOBND GARH	B101FL16	hansa concast	AMR	OK	31.03.2023	Category 3				2067916	1200-600/5	30.211	NA	Director/D		
B.3003	Central	KHANNA	11KV	D5 (S/PL/DVN/M/GOBINT+H) (DSISPL S/Div M/GOBND GARH	B102FL05	Central	AMR	OK	31.03.2023	Category 2				2068388	1200-600/5	3.288	NA	Director/D		
B.3004	Central	KHANNA	11KV	D5 (S/PL/DVN/M/GOBINT+H) (DSISPL S/Div M/GOBND GARH	D112FL14	Shri Ram Jain	AMR	OK	31.03.2023	Category 2				2068207	1200-600/5	5.346	NA	Director/D		
B.3005	Central	KHANNA	11KV	D5 (S/PL/DVN/M/GOBINT+H) (DSISPL S/Div M/GOBND GARH	D112FL13	Deep	AMR	OK	31.03.2023	Category 2				2068468	1200-600/5	5.382	NA	Director/D		
B.3006	Central	KHANNA	11KV	D5 (S/PL/DVN/M/GOBINT+H) (DSISPL S/Div M/GOBND GARH	B102FL11	Mugoli Majra	AMR	OK	31.03.2023	Category 2				8222408	1200-600/5	6.120	NA	Director/D		
B.3007	Central	KHANNA	11KV	D5 (S/PL/DVN/M/GOBINT+H) (DSISPL S/Div M/GOBND GARH	B102FL10	Labour Colony	AMR	OK	31.03.2023	Category 1				7042890	1200-600/5	9.918	NA	Director/D		
B.3008	Central	KHANNA	11KV	D5 (S/PL/DVN/M/GOBINT+H) (DSISPL S/Div M/GOBND GARH	B102FL19	Omara Agro and Steel	AMR	OK	31.03.2023	Category 3				1218789	400-200/5-5	10.629	NA	Director/D		
B.3009	Central	KHANNA	11KV	D5 (S/PL/DVN/M/GOBINT+H) (DSISPL S/Div M/GOBND GARH	D112FL23	PEPSU	AMR	OK	31.03.2023	Category 2				7336474	1200-600/5	0.097	NA	Director/D		
B.3010	Central	KHANNA	11KV	D5 (S/PL/DVN/M/GOBINT+H) (DSISPL S/Div M/GOBND GARH	D112FL10	TELEPHONE EXCH.	AMR	OK	31.03.2023	Category 4				5341550	1200-600/5	0.120	NA	Director/D		
B.3011	Central	KHANNA	11KV	D5 (S/PL/DVN/M/GOBINT+H) (DSISPL S/Div M/GOBND GARH	D112FL09	Royal	AMR	OK	31.03.2023	Category 2				4129655	1200-600/5	4.517	NA	Director/D		
B.3012	Central	KHANNA	11KV	D5 (S/PL/DVN/M/GOBINT+H) (DSISPL S/Div M/GOBND GARH	D112FL11	Punjab Mill	AMR	OK	31.03.2023	Category 2				8222402	1200-600/5	4.869	NA	Director/D		
B.3013	Central	KHANNA	11KV	D5 (S/PL/DVN/M/GOBINT+H) (DSISPL S/Div M/GOBND GARH	D112FL12	Surindra	AMR	OK	31.03.2023	Category 2				2064377	1200-600/5	29.322	NA	Director/D		
B.3014	Central	KHANNA	11KV	D5 (S/PL/DVN/M/GOBINT+H) (DSISPL S/Div M/GOBND GARH	D112FL22	SHIVPURI	AMR	OK	31.03.2023	Category 2				5295711	1200-600/5	5.311	NA	Director/D		
B.3015	Central	KHANNA	11KV	D5 (S/PL/DVN/M/GOBINT+H) (DSISPL S/Div M/GOBND GARH	D112FL25	JASARA	AMR	OK	31.03.2023	Category 1				126587	400-200/5-5	5.857	NA	Director/D		
B.3016	Central	KHANNA	11KV	D5 (S/PL/DVN/M/GOBINT+H) (DSISPL S/Div M/GOBND GARH	D112FL01	Motia Khan	AMR	OK	31.03.2023	Category 1				2067769	1200-600/5	6.747	NA	Director/D		
B.3017	Central	KHANNA	11KV	D5 (S/PL/DVN/M/GOBINT+H) (DSISPL S/Div M/GOBND GARH	D112FL06	Doaba	AMR	OK	31.03.2023	Category 2				125478	400-200/5-5	7.403	NA	Director/D		
B.3018	Central	KHANNA	11KV	D5 (S/PL/DVN/M/GOBINT+H) (DSISPL S/Div M/GOBND GARH	D112FL03	Chander Lok	AMR	OK	31.03.2023	Category 1				8227985	1200-600/5	9.247	NA	Director/D		
B.3019	Central	KHANNA	11KV	D5 (S/PL/DVN/M/GOBINT+H) (DSISPL S/Div M/GOBND GARH	D112FL15	Sangta	AMR	OK	31.03.2023	Category 1				1257815	400-200/5-5	10.500	NA	Director/D		
B.3020	Central	KHANNA	11KV	D5 (S/PL/DVN/M/GOBINT+H) (DSISPL S/Div M/GOBND GARH	D101FL08	Misri Majri	AMR	OK	31.03.2023	Category 2				AP 3Phase 3Wire	9141173	1200-600/5	1.934	NA	Director/D	
B.3021	Central	KHANNA	11KV	D5 (S/PL/DVN/M/GOBINT+H) (DSISPL S/Div M/GOBND GARH	D125FL17	CHANKYA BAIKARY	AMR	OK	31.03.2023	Category 4				7042943	1200-600/5	2.275	NA	Director/D		
B.3022	Central	KHANNA	11KV	D5 (S/PL/DVN/M/GOBINT+H) (DSISPL S/Div M/GOBND GARH	D125FL36	CHANAKYA DAIRY UNIT -2	AMR	OK	31.03.2023	Category 2				125478	400-200/5-5	2.622	NA	Director/D		
B.3023	Central	KHANNA	11KV	D5 (S/PL/DVN/M/GOBINT+H) (DSISPL S/Div M/GOBND GARH	D125FL06	SULEKHI RAM	AMR	OK	31.03.2023	Category 2				2067771	1200-600/5	3.483	NA	Director/D		
B.3024	Central	KHANNA	11KV	D5 (S/PL/DVN/M/GOBINT+H) (DSISPL S/Div M/GOBND GARH	D125FL29	CHANAKYA DAIRY	AMR	OK	31.03.2023	Category 4				3206494	1200-600/5	6.068	NA	Director/D		
B.3025	Central	KHANNA	11KV	D5 (S/PL/DVN/M/GOBINT+H) (DSISPL S/Div M/GOBND GARH	D125FL19	NARINDRA	AMR	OK	31.03.2023	Category 3				125478	400-200/5-5	6.576	NA	Director/D		
B.3026	Central	KHANNA	11KV	D5 (S/PL/DVN/M/GOBINT+H) (DSISPL S/Div M/GOBND GARH	D125FL16	K.K ALLOYS	AMR	OK	31.03.2023	Category 2				125877	400-200/5-5	6.920	NA	Director/D		
B.3027	Central	KHANNA	11KV	D5 (S/PL/DVN/M/GOBINT+H) (DSISPL S/Div M/GOBND GARH	D125FL34	R.P SALES	AMR	OK	31.03.2023	Category 2				11116111	1200-600/5	7.274	NA	Director/D		
B.3028	Central	KHANNA	11KV	D5 (S/PL/DVN/M/GOBINT+H) (DSISPL S/Div M/GOBND GARH	D125FL03	FOCAL POINT(66KV GRID FOCAL)	AMR	OK	31.03.2023	Category 2				2067247	1200-600/5	8.086	NA	Director/D		
B.3029	Central	KHANNA	11KV	D5 (S/PL/DVN/M/GOBINT+H) (DSISPL S/Div M/GOBND GARH	D125FL02	ARUN	AMR	OK	31.03.2023	Category 2				2067766	1200-600/5	8.840	NA	Director/D		
B.3030	Central	KHANNA	11KV	D5 (S/PL/DVN/M/GOBINT+H) (DSISPL S/Div M/GOBND GARH	D125FL01	BANSI WALA	AMR	OK	31.03.2023	Category 2				1215887	400-200/5-5	8.431	NA	Director/D		
B.3031	Central	KHANNA	11KV	D5 (S/PL/DVN/M/GOBINT+H) (DSISPL S/Div M/GOBND GARH	D125FL35	MODERN AUTOMOTIVE	AMR	OK	31.03.2023	Category 2				12092501	1200-600/5	9.066	NA	Director/D		
B.3032	Central	KHANNA	11KV	D5 (S/PL/DVN/M/GOBINT+H) (DSISPL S/Div M/GOBND GARH	D125FL33	NAMDEV	AMR	OK	31.03.2023	Category 2				11116982	1200-600/5	11.224	NA	Director/D		
B.3033	Central	KHANNA	11KV	D5 (S/PL/DVN/M/GOBINT+H) (DSISPL S/Div M/GOBND GARH	D125FL18	A.K.	AMR	OK	31.03.2023	Category 3				9154226	1200-600/5	13.906	NA	Director/D		
B.3034	Central	KHANNA	11KV	D5 (S/PL/DVN/M/GOBINT+H) (DSISPL S/Div M/GOBND GARH	D125FL28	GOJULI	AMR	OK	31.03.2023	Category 3				2068710	1200-600/5	18.496	NA	Director/D		
B.3035	Central	KHANNA	11KV	D5 (S/PL/DVN/M/GOBINT+H) (DSISPL S/Div M/GOBND GARH	D125FL38	Devi Koonoli	AMR	OK	31.03.2023	Category 3				125478	400-200/5-5	28.262	NA	Director/D		
B.3036	Central	KHANNA	11KV	D5 (S/PL/DVN/M/GOBINT+H) (DSISPL S/Div M/GOBND GARH	D125FL05	Neel Kanth	AMR	OK	31.03.2023	Category 3				124578	1200-600/5	29.452	NA	Director/D		
B.3037	Central	KHANNA	11KV	D5 (S/PL/DVN/M/GOBINT+H) (DSISPL S/Div M/GOBND GARH	D128FL01	LADPUR	NON AMR	OK	31.03.2023	Category 2				AP 3Phase 3Wire	126548	400-200/5-5	2.188	NA	Director/D	
B.3038	Central	KHANNA	11KV	D5 (S/PL/DVN/M/GOBINT+H) (DSISPL S/Div M/GOBND GARH	D128FL03	SIMRAN(JALALPUR)	AMR	OK	31.03.2023	Category 2				12093562	1200-600/5	2.852	NA	Director/D		
B.3039	Central	KHANNA	11KV	D5 (S/PL/DVN/M/GOBINT+H) (DSISPL S/Div M/GOBND GARH	D128FL08	Sollair	NON AMR	OK	31.03.2023	Category 2				124584	400-200/5-5	7.322	NA	Director/D		
B.3040	Central	KHANNA	11KV	D5 (S/PL/DVN/M/GOBINT+H) (DSISPL S/Div M/GOBND																

S.No	Zone	Circle	Voltage Level (kVA)	Division (kVA)	Sub-Division (kVA)	Feeder ID	Feeder Name	Feeder Metering Status (Metered/unmetered/AM/AMR)	Status of Meter (Functional/Non-Functional)	Metering Date (Date of last actual meter reading/communication)	Feeder Type (Agr/Industrial/Mixed)	Status of Communication			Period from 01.04.2021 to 31.03.2022				Sales	Remarks (Source of data)
												% data received through automatically if feeder AMR/AM	Number of hours when meter was unable to communicate in overall	Total Number of hours in the period	Meter S.No	CT/PT ratio	Import (kWh)	Export (kWh)		
B.3074	Central	KHANNA	11KV	DS (SPL/DV/M/GOBINT+H)	(DS)SPL S/DV/M/GOBIND GARH	B01FL06	R.G.	AMR	OK	31.03.2023	Category 2				2068651	1200-600/5	9.014	NA	Director/D	
B.3075	Central	KHANNA	11KV	DS (SPL/DV/M/GOBINT+H)	(DS)SPL S/DV/M/GOBIND GARH	D02SF09	Sher-e-Punjab	AMR	OK	31.03.2023	Category 2				7326423	1200-600/5	9.613	NA	Director/D	
B.3076	Central	KHANNA	11KV	DS (SPL/DV/M/GOBINT+H)	(DS)SPL S/DV/M/GOBIND GARH	D01FL07	Sub Station Load (Khanna Steel)	AMR	OK	31.03.2023	Category 3				5390832	1200-600/5	0.000	NA	Director/D	
B.3077	Central	KHANNA	11KV	DS (SPL/DV/M/GOBINT+H)	(DS)SPL S/DV/M/GOBIND GARH	D01FL03	Gain Casting	AMR	OK	31.03.2023	Category 2				2068446	1200-600/5	0.333	NA	Director/D	
B.3078	Central	KHANNA	11KV	DS (SPL/DV/M/GOBINT+H)	(DS)SPL S/DV/M/GOBIND GARH	D011FL11	GAN CASTING (Grain Mkt)	AMR	OK	31.03.2023	Category 3				2068198	1200-600/5	1.006	NA	Director/D	
B.3079	Central	KHANNA	11KV	DS (SPL/DV/M/GOBINT+H)	(DS)SPL S/DV/M/GOBIND GARH	D011FL05	Bhadia	AMR	OK	31.03.2023	AP 3Phase 3Wire				4221159	1200-600/5	2.275	NA	Director/D	
B.3080	Central	KHANNA	11KV	DS (SPL/DV/M/GOBINT+H)	(DS)SPL S/DV/M/GOBIND GARH	D011FL10	Kamal	AMR	OK	31.03.2023	Category 2				4221062	1200-600/5	3.035	NA	Director/D	
B.3081	Central	KHANNA	11KV	DS (SPL/DV/M/GOBINT+H)	(DS)SPL S/DV/M/GOBIND GARH	D011FL01	Dadhari	AMR	OK	31.03.2023	AP 3Phase 3Wire				2047072	1200-600/5	3.244	NA	Director/D	
B.3082	Central	KHANNA	11KV	DS (SPL/DV/M/GOBINT+H)	(DS)SPL S/DV/M/GOBIND GARH	D011FL12	RAJIK	AMR	OK	31.03.2023	Category 2				1214469	400-200/5-5	4.463	NA	Director/D	
B.3083	Central	KHANNA	11KV	DS (SPL/DV/M/GOBINT+H)	(DS)SPL S/DV/M/GOBIND GARH	D011FL12	Ashwad	AMR	OK	31.03.2023	Category 2				7035652	1200-600/5	6.093	NA	Director/D	
B.3084	Central	KHANNA	11KV	DS (SPL/DV/M/GOBINT+H)	(DS)SPL S/DV/M/GOBIND GARH	D011FL02	Deepak	AMR	OK	31.03.2023	Category 2				5342489	1200-600/5	7.052	NA	Director/D	
B.3085	Central	KHANNA	11KV	DS (SPL/DV/M/GOBINT+H)	(DS)SPL S/DV/M/GOBIND GARH	D011FL14	Kotla	AMR	OK	31.03.2023	Category 5-U/PS				125879	400-200/5-5	7.805	NA	Director/D	
B.3086	Central	KHANNA	11KV	DS (SPL/DV/M/GOBINT+H)	(DS)SPL S/DV/M/GOBIND GARH	D011FL04	Grian Market	NON AMR	OK	31.03.2023	Category 2				2066545	1200-600/5	8.670	NA	Director/D	
B.3087	Central	KHANNA	11KV	DS (SPL/DV/M/GOBINT+H)	(DS)SPL S/DV/M/GOBIND GARH	D011FL19	DH CASTING	AMR	OK	31.03.2023	Category 3				30319	1200-600/5	17.487	NA	Director/D	
B.3088	Central	KHANNA	11KV	DS (SPL/DV/M/GOBINT+H)	(DS)SPL S/DV/M/GOBIND GARH	D011FL22	TAXUS STEEL	NON AMR	OK	31.03.2023	Category 3				124587	1200-600/5	20.939	NA	Director/D	
B.3089	Central	KHANNA	11KV	DS (SPL/DV/M/GOBINT+H)	(DS)SPL S/DV/M/GOBIND GARH	D011FL18	STEEL TECH	AMR	OK	31.03.2023	Category 3				10273731	1200-600/5	22.172	NA	Director/D	
B.3090	Central	KHANNA	11KV	DS (SPL/DV/M/GOBINT+H)	(DS)SPL S/DV/M/GOBIND GARH	D011FL09	Agri Casting	AMR	OK	31.03.2023	Category 2				6607228	1200-600/5	29.431	NA	Director/D	
B.3091	Central	KHANNA	11KV	DS (SPL/DV/M/GOBINT+H)	(DS)SPL S/DV/M/GOBIND GARH	D011FL20	Samana	AMR	OK	31.03.2023	Category 2				6676968	1200-600/5	0.394	NA	Director/D	
B.3092	Central	KHANNA	11KV	DS (SPL/DV/M/GOBINT+H)	(DS)SPL S/DV/M/GOBIND GARH	D011FL21	JANDALI	AMR	OK	31.03.2023	Category 5-U/PS				2047144	1200-600/5	2.083	NA	Director/D	
B.3093	Central	KHANNA	11KV	DS (SPL/DV/M/GOBINT+H)	(DS)SPL S/DV/M/GOBIND GARH	D011FL22	RAJIK	AMR	OK	31.03.2023	Category 2				9140703	1200-600/5	3.203	NA	Director/D	
B.3094	Central	KHANNA	11KV	DS (SPL/DV/M/GOBINT+H)	(DS)SPL S/DV/M/GOBIND GARH	D011FL03	Jai Bharat	AMR	OK	31.03.2023	Category 2				9141114	1200-600/5	3.145	NA	Director/D	
B.3095	Central	KHANNA	11KV	DS (SPL/DV/M/GOBINT+H)	(DS)SPL S/DV/M/GOBIND GARH	D011FL02	Suresh Goyal	NON AMR	OK	31.03.2023	Category 3				9568260	1200-600/5	3.154	NA	Director/D	
B.3096	Central	KHANNA	11KV	DS (SPL/DV/M/GOBINT+H)	(DS)SPL S/DV/M/GOBIND GARH	D011FL08	Gian Casting	AMR	OK	31.03.2023	Category 2				30264	1200-600/5	3.179	NA	Director/D	
B.3097	Central	KHANNA	11KV	DS (SPL/DV/M/GOBINT+H)	(DS)SPL S/DV/M/GOBIND GARH	D011FL08	S & S	AMR	OK	31.03.2023	Category 2				9568273	1200-600/5	3.493	NA	Director/D	
B.3098	Central	KHANNA	11KV	DS (SPL/DV/M/GOBINT+H)	(DS)SPL S/DV/M/GOBIND GARH	D011FL19	FORTUNE	AMR	OK	31.03.2023	Category 2				4187793	1200-600/5	3.556	NA	Director/D	
B.3099	Central	KHANNA	11KV	DS (SPL/DV/M/GOBINT+H)	(DS)SPL S/DV/M/GOBIND GARH	D011FL15	MADHAV	NON AMR	OK	31.03.2023	Category 2				2044659	1200-600/5	3.712	NA	Director/D	
B.3100	Central	KHANNA	11KV	DS (SPL/DV/M/GOBINT+H)	(DS)SPL S/DV/M/GOBIND GARH	D011FL01	Aman	AMR	OK	31.03.2023	Category 2				30338	1200-600/5	3.864	NA	Director/D	
B.3101	Central	KHANNA	11KV	DS (SPL/DV/M/GOBINT+H)	(DS)SPL S/DV/M/GOBIND GARH	D011FL04	R.K.	AMR	OK	31.03.2023	Category 2				8223605	1200-600/5	3.955	NA	Director/D	
B.3102	Central	KHANNA	11KV	DS (SPL/DV/M/GOBINT+H)	(DS)SPL S/DV/M/GOBIND GARH	D011FL12	J.T.G.	AMR	OK	31.03.2023	Category 2				6775539	1200-600/5	4.795	NA	Director/D	
B.3103	Central	KHANNA	11KV	DS (SPL/DV/M/GOBINT+H)	(DS)SPL S/DV/M/GOBIND GARH	D011FL14	JOGINORA	AMR	OK	31.03.2023	Category 2				9140902	1200-600/5	5.529	NA	Director/D	
B.3104	Central	KHANNA	11KV	DS (SPL/DV/M/GOBINT+H)	(DS)SPL S/DV/M/GOBIND GARH	D011FL13	SONA CASTING	AMR	OK	31.03.2023	Category 2				8223786	1200-600/5	5.983	NA	Director/D	
B.3105	Central	KHANNA	11KV	DS (SPL/DV/M/GOBINT+H)	(DS)SPL S/DV/M/GOBIND GARH	D011FL06	ALURNE	AMR	OK	31.03.2023	Category 2				2065987	1200-600/5	6.171	NA	Director/D	
B.3106	Central	KHANNA	11KV	DS (SPL/DV/M/GOBINT+H)	(DS)SPL S/DV/M/GOBIND GARH	D011FL05	LUXMI	AMR	OK	31.03.2023	Category 2				9140901	1200-600/5	6.210	NA	Director/D	
B.3107	Central	KHANNA	11KV	DS (SPL/DV/M/GOBINT+H)	(DS)SPL S/DV/M/GOBIND GARH	D011FL09	VISHWANATH	AMR	OK	31.03.2023	Category 2				8223797	1200-600/5	6.414	NA	Director/D	
B.3108	Central	KHANNA	11KV	DS (SPL/DV/M/GOBINT+H)	(DS)SPL S/DV/M/GOBIND GARH	D011FL11	TALWARA	AMR	OK	31.03.2023	AP 3Phase 3Wire				6485858	1200-600/5	8.888	NA	Director/D	
B.3109	Central	KHANNA	11KV	DS (SPL/DV/M/GOBINT+H)	(DS)SPL S/DV/M/GOBIND GARH	D011FL10	SAGGAR	AMR	OK	31.03.2023	Category 3				9140904	1200-600/5	13.042	NA	Director/D	
B.3110	Central	KHANNA	11KV	DS (SPL/DV/M/GOBINT+H)	(DS)SPL S/DV/M/GOBIND GARH	D011FL18	K.L.ALDYS	AMR	OK	31.03.2023	Category 3				299373	1200-600/5	19.340	NA	Director/D	
B.3111	Central	KHANNA	11KV	DS (SPL/DV/M/GOBINT+H)	(DS)SPL S/DV/M/GOBIND GARH	D011FL07	M.A.L.	NON AMR	OK	31.03.2023	Category 3				8223350	1200-600/5	21.008	NA	Director/D	
B.3112	Central	KHANNA	11KV	DS (SPL/DV/M/GOBINT+H)	(DS)SPL S/DV/M/GOBIND GARH	D011FL17	KUBER	Not available	OK	31.03.2023	Category 3				30335	1200-600/5	23.025	NA	Director/D	
B.3113	Central	KHANNA	66KV	DS (SPL/DV/M/GOBINT+H)	(DS)SPL S/DV/M/GOBIND GARH	D011FL23	kisco casting	Not available	OK	31.03.2023	Category 3				Not available	Not available	19.529	NA	Director/D	
B.3114	Central	KHANNA	66KV	DS (SPL/DV/M/GOBINT+H)	(DS)SPL S/DV/M/GOBIND GARH	D011FL36	Gain Casting	Not available	OK	31.03.2023	Category 3				Not available	Not available	43.638	NA	Director/D	
B.3115	Central	KHANNA	66KV	DS (SPL/DV/M/GOBINT+H)	(DS)SPL S/DV/M/GOBIND GARH	B01DL06	MIDDEEN STEEL	Not available	OK	31.03.2023	Category 3				Not available	Not available	83.784	NA	Director/D	
B.3116	Central	KHANNA	66KV	DS (SPL/DV/M/GOBINT+H)	(DS)SPL S/DV/M/GOBIND GARH	B01DL09	MANI (66 KV)	Not available	OK	31.03.2023	Category 3				Not available	Not available	89.876	NA	Director/D	
B.3117	Central	KHANNA	66KV	DS (SPL/DV/M/GOBINT+H)	(DS)SPL S/DV/M/GOBIND GARH	D011FL23	RAJIK INDUSTRIES	Not available	OK	31.03.2023	Category 3				Not available	Not available	93.460	NA	Director/D	
B.3118	Central	KHANNA	66KV	DS (SPL/DV/M/GOBINT+H)	(DS)SPL S/DV/M/GOBIND GARH	D011FL25	Fortune Multimetal	Not available	OK	31.03.2023	Category 3				Not available	Not available	124.992	NA	Director/D	
B.3119	Central	KHANNA	66KV	DS (SPL/DV/M/GOBINT+H)	(DS)SPL S/DV/M/GOBIND GARH	D011DL05	Oasis Ind.	Not available	OK	31.03.2023	Category 3				Not available	Not available	126.600	NA	Director/D	
B.3120	Central	KHANNA	66KV	DS (SPL/DV/M/GOBINT+H)	(DS)SPL S/DV/M/GOBIND GARH	B02FL21	CHOPRA ALLOYS	Not available	OK	31.03.2023	Category 3				Not available	Not available	162.840	NA	Director/D	
B.3121	Central	KHANNA	66KV	DS (SPL/DV/M/GOBINT+H)	(DS)SPL S/DV/M/GOBIND GARH	B01DL07	Jyoti Benari	NON AMR	OK	31.03.2023	Category 3				Not available	Not available	164.860	NA	Director/D	
B.3122	Central	KHANNA	11KV	DS DIVN. AMLOH	DS S/D AMLOH	B03FL07	KC STEEL	AMR	OK	31.03.2023	Category 5				123456	1200-600/5	0.000	NA	Director/D	
B.3123	Central	KHANNA	11KV	DS DIVN. AMLOH	DS S/D AMLOH	B03FL13	BHARAT TUBE	AMR	OK	31.03.2023	Category 5-U/PS				11052984	1200-600/5	0.000	NA	Director/D	
B.3124	Central	KHANNA	11KV	DS DIVN. AMLOH	DS S/D AMLOH	B02FL37	Hababura	AMR	OK	31.03.2023	AP 3Phase 3Wire				124588	1200/577/1-1-1	0.019	NA	Director/D	
B.3125	Central	KHANNA	11KV	DS DIVN. AMLOH	DS S/D AMLOH	B03FL35	MANGARH ROAD	AMR	OK	31.03.2023	Category 1				13190593	1200-600/5	0.152	NA	Director/D	
B.3126	Central	KHANNA	11KV	DS DIVN. AMLOH	DS S/D AMLOH	B03FL07	Roorki	AMR	OK	31.03.2023	AP 3Phase 3Wire				123454	1200/577/1-1-1	1.910	NA	Director/D	
B.3127	Central	KHANNA	11KV	DS DIVN. AMLOH	DS S/D AMLOH	B03FL04	YARACHAN	AMR	OK	31.03.2023	AP 3Phase 3Wire				2067018	1200-600/5	1.947	NA	Director/D	
B.3128	Central	KHANNA	11KV	DS DIVN. AMLOH	DS S/D AMLOH	B03FL06	JHAMBALA	AMR	OK	31.03.2023	AP 3Phase 3Wire				123547	1200/577/1-1-1	1.974	NA	Director/D	
B.3129	Central	KHANNA	11KV	DS DIVN. AMLOH	DS S/D AMLOH	B03FL02	Kaulgar	AMR	OK	31.03.2023	AP 3Phase 3Wire				125687	1200/577/1-1-1	2.073	NA	Director/D	
B.3130	Central	KHANNA	11KV	DS DIVN. AMLOH	DS S/D AMLOH	B03FL26	Aminya AP	AMR	OK	31.03.2023	AP 3Phase 3Wire				11114603	1200-600/5	2.444	NA	Director/D	
B.3131	Central	KHANNA	11KV	DS DIVN. AMLOH	DS S/D AMLOH	B03FL28	NORPURA	AM												

S.No	Zone	Circle	Voltage Level (kVA)	Division (kVA)	Sub-Division (kVA)	Feeder ID	Feeder Name	Feeder Metering Status (Metered/unmetered/AMR/AMI)	Status of Meter (Functional/Non-Functional)	Metering Date	Date of last actual meter reading/communication	Feeder Type (Agr./Industrial/Mixed)	Status of Communication			Period from 01.04.2021 to 31.03.2022				Sales	Remarks (Source of data)
													% Data received through automatically if feeder AMR/AMI	Number of hours when meter was unable to communicate in overall	Total Number of hours in the period	Meter S.No	CT/PT ratio	Import (kU)	Export (kU)		
B.3171	Central	KHANNA	11KV	DS DIVN. AMLDH	DS S/D BHADSON	D122FL05	Rani dheer	AMR	OK	31.03.2023		Category 5-UPS				6761898	1200-600/5	4.609	NA	Director/D	
B.3172	Central	KHANNA	11KV	DS DIVN. AMLDH	DS S/D BHADSON	D115FL24	DARGAPUR AP	AMR	OK	31.03.2023		AP 3Phase 3Wire				125789	1200-600/5	0.886	NA	Director/D	
B.3173	Central	KHANNA	11KV	DS DIVN. AMLDH	DS S/D BHADSON	D115FL07	Khanaura	AMR	OK	31.03.2023		AP 3Phase 3Wire				2067659	900-450/5	1.265	NA	Director/D	
B.3174	Central	KHANNA	11KV	DS DIVN. AMLDH	DS S/D BHADSON	D115FL16	Reali	AMR	OK	31.03.2023		AP 3Phase 3Wire				1251789	900-450/5	1.577	NA	Director/D	
B.3175	Central	KHANNA	11KV	DS DIVN. AMLDH	DS S/D BHADSON	D115FL21	Ranno	AMR	OK	31.03.2023		AP 3Phase 3Wire				125487	1200-600/5	1.608	NA	Director/D	
B.3176	Central	KHANNA	11KV	DS DIVN. AMLDH	DS S/D BHADSON	D115FL05	Mallewal	AMR	OK	31.03.2023		AP 3Phase 3Wire				125879	1200-600/5	1.631	NA	Director/D	
B.3177	Central	KHANNA	11KV	DS DIVN. AMLDH	DS S/D BHADSON	D115FL01	Bhari	AMR	OK	31.03.2023		AP 3Phase 3Wire				418652	1200-600/5	1.710	NA	Director/D	
B.3178	Central	KHANNA	11KV	DS DIVN. AMLDH	DS S/D BHADSON	D115FL19	Bhagwarpura	AMR	OK	31.03.2023		AP 3Phase 3Wire				123578	1200-600/5	1.818	NA	Director/D	
B.3179	Central	KHANNA	11KV	DS DIVN. AMLDH	DS S/D BHADSON	D115FL02	Padni	AMR	OK	31.03.2023		AP 3Phase 3Wire				2064704	1200-600/5	2.031	NA	Director/D	
B.3180	Central	KHANNA	11KV	DS DIVN. AMLDH	DS S/D BHADSON	D115FL06	Tarkheri	AMR	OK	31.03.2023		AP 3Phase 3Wire				67611882	900-450/5	2.110	NA	Director/D	
B.3181	Central	KHANNA	11KV	DS DIVN. AMLDH	DS S/D BHADSON	D115FL20	Jindalpur	AMR	OK	31.03.2023		AP 3Phase 3Wire				2066353	1200-600/5	2.133	NA	Director/D	
B.3182	Central	KHANNA	11KV	DS DIVN. AMLDH	DS S/D BHADSON	D115FL03	Chahal	AMR	OK	31.03.2023		AP 3Phase 3Wire				7336651	1200-600/5	2.138	NA	Director/D	
B.3183	Central	KHANNA	11KV	DS DIVN. AMLDH	DS S/D BHADSON	D115FL08	Sudhewal	AMR	OK	31.03.2023		AP 3Phase 3Wire				126458	1200-600/5	2.229	NA	Director/D	
B.3184	Central	KHANNA	11KV	DS DIVN. AMLDH	DS S/D BHADSON	D115FL17	ghunder	AMR	OK	31.03.2023		Category 5-UPS				124789	900-450/5	2.398	NA	Director/D	
B.3185	Central	KHANNA	11KV	DS DIVN. AMLDH	DS S/D BHADSON	D115FL22	Lout	NON AMR	OK	31.03.2023		AP 3Phase 3Wire				125478	900-450/5	2.465	NA	Director/D	
B.3186	Central	KHANNA	11KV	DS DIVN. AMLDH	DS S/D BHADSON	D115FL10	Nanoki	AMR	OK	31.03.2023		AP 3Phase 3Wire				10282982	1200-600/5	2.477	NA	Director/D	
B.3187	Central	KHANNA	11KV	DS DIVN. AMLDH	DS S/D BHADSON	D115FL09	Sandholi	AMR	OK	31.03.2023		AP 3Phase 3Wire				2047169	900-450/5	2.587	NA	Director/D	
B.3188	Central	KHANNA	11KV	DS DIVN. AMLDH	DS S/D BHADSON	D115FL15	KARTAR AGRO	AMR	OK	31.03.2023		Category 2				123874	900-450/5	3.019	NA	Director/D	
B.3189	Central	KHANNA	11KV	DS DIVN. AMLDH	DS S/D BHADSON	D115FL18	Akalgarh	AMR	OK	31.03.2023		Category 5-UPS				125745	900-450/5	5.126	NA	Director/D	
B.3190	Central	KHANNA	11KV	DS DIVN. AMLDH	DS S/D BHADSON	D115FL04	Bhadson	AMR	OK	31.03.2023		Category 1				4253103	1200-600/5	5.486	NA	Director/D	
B.3191	Central	KHANNA	11KV	DS DIVN. AMLDH	DS S/D BHADSON	D115FL25	CHASWAL UPS	AMR	OK	31.03.2023		Category 5-UPS				8222769	900-450/5	5.521	NA	Director/D	
B.3192	Central	KHANNA	11KV	DS DIVN. AMLDH	DS S/D BHADSON	D115FL13	Shamshpur UPS	AMR	OK	31.03.2023		Category 5-UPS				125964	900-450/5	5.700	NA	Director/D	
B.3193	Central	KHANNA	11KV	DS DIVN. AMLDH	DS S/D BHADSON	D115FL14	Pattala Road	AMR	OK	31.03.2023		Category 1				123456	900-450/5	7.571	NA	Director/D	
B.3194	Central	KHANNA	11KV	DS DIVN. AMLDH	DS S/D BHADSON	T130FL06	LOPE AP	AMR	OK	31.03.2023		AP 3Phase 3Wire				125478	1200/577/1-1-1	1.152	NA	Director/D	
B.3195	Central	KHANNA	11KV	DS DIVN. AMLDH	DS S/D BHADSON	D130FL05	MALLEWAL CAT-1	NON AMR	OK	31.03.2023		Category 1				216584	1200/577/1-1-1	1.897	NA	Director/D	
B.3196	Central	KHANNA	11KV	DS DIVN. AMLDH	DS S/D BHADSON	D115FL01	Bhose	AMR	OK	31.03.2023		AP 3Phase 3Wire				123456	1200/577/1-1-1	2.094	NA	Director/D	
B.3197	Central	KHANNA	11KV	DS DIVN. AMLDH	DS S/D BHADSON	T130FL04	Raisal	AMR	OK	31.03.2023		AP 3Phase 3Wire				123456	1200/577/1-1-1	2.289	NA	Director/D	
B.3198	Central	KHANNA	11KV	DS DIVN. AMLDH	DS S/D BHADSON	T130FL02	Kalana	AMR	OK	31.03.2023		AP 3Phase 3Wire				123456	1200/577/1-1-1	2.550	NA	Director/D	
B.3199	Central	KHANNA	11KV	DS DIVN. AMLDH	DS S/D BHADSON	T130FL03	Mallewal	AMR	OK	31.03.2023		AP 3Phase 3Wire				123456	1200/577/1-1-1	2.724	NA	Director/D	
B.3200	Central	KHANNA	11KV	DS DIVN. AMLDH	DS S/D BHADSON	T130FL05	Gobindpura	AMR	OK	31.03.2023		Category 5-UPS				123456	1200/577/1-1-1	5.190	NA	Director/D	
B.3201	Central	KHANNA	11KV	DS DIVN. AMLDH	DS S/D BHADSON	D133FL10	Khanaura UPS	AMR	OK	31.03.2023		Category 5-UPS				125478	400-200/5-5	1.519	NA	Director/D	
B.3202	Central	KHANNA	11KV	DS DIVN. AMLDH	DS S/D BHADSON	D133FL05	PUNNIVAL AP	AMR	OK	31.03.2023		AP 3Phase 3Wire				124587	400-200/5-5	2.195	NA	Director/D	
B.3203	Central	KHANNA	11KV	DS DIVN. AMLDH	DS S/D BHADSON	D133FL05	Gobindpura	AMR	OK	31.03.2023		AP 3Phase 3Wire				15193833	400-200/5-5	2.541	NA	Director/D	
B.3204	Central	KHANNA	11KV	DS DIVN. AMLDH	DS S/D BHADSON	D197FL12	PEDHAN	NON AMR	OK	31.03.2023		AP 3Phase 3Wire				1451	Not installed	1.790	NA	Director/D	
B.3205	Central	KHANNA	11KV	DS DIVN. AMLDH	DS S/D BHADSON	B196FL06	Ware	Not available	OK	31.03.2023		AP 3Phase 3Wire				11116759	Not installed	2.581	NA	Director/D	
B.3206	Central	KHANNA	66KV	DS DIVN. AMLDH	DS S/D BHADSON	B107FL22	Madhav Alloys	AMR	OK	31.03.2023		Category 3				Not available	Not available	199.394	NA	Director/D	
B.3207	Central	KHANNA	11KV	DS DIVN. AMLDH	DS S/D SHAMSHPUR	D113FL11	RAJEWAL CAT-1	AMR	OK	31.03.2023		Category 1				125478	400-200/5-5	0.591	NA	Director/D	
B.3208	Central	KHANNA	11KV	DS DIVN. AMLDH	DS S/D SHAMSHPUR	D133FL07	HIMMATGARH CHANNA AP	NON AMR	OK	31.03.2023		AP 3Phase 3Wire				1245698	400-200/5-5	1.403	NA	Director/D	
B.3209	Central	KHANNA	11KV	DS DIVN. AMLDH	DS S/D SHAMSHPUR	P131FP01	Mallowal	NON AMR	OK	31.03.2023		AP 3Phase 3Wire				123654	400-200/5-5	1.694	NA	Director/D	
B.3210	Central	KHANNA	11KV	DS DIVN. AMLDH	DS S/D SHAMSHPUR	P131FP02	Rayawal	AMR	OK	31.03.2023		AP 3Phase 3Wire				123547	400-200/5-5	1.805	NA	Director/D	
B.3211	Central	KHANNA	11KV	DS DIVN. AMLDH	DS S/D SHAMSHPUR	P131FL09	RURKI UPS	AMR	OK	31.03.2023		Category 5-UPS				124587	400-200/5-5	2.104	NA	Director/D	
B.3212	Central	KHANNA	11KV	DS DIVN. AMLDH	DS S/D SHAMSHPUR	P131FL08	TIBBI UPS	AMR	OK	31.03.2023		Category 5-UPS				124587	400-200/5-5	2.704	NA	Director/D	
B.3213	Central	KHANNA	11KV	DS DIVN. AMLDH	DS S/D SHAMSHPUR	D113FL11	Phang	AMR	OK	31.03.2023		AP 3Phase 3Wire				2067511	900-450/5	2.696	NA	Director/D	
B.3214	Central	KHANNA	11KV	DS DIVN. AMLDH	DS S/D SHAMSHPUR	D116FL10	SHAMASHPUR	AMR	OK	31.03.2023		Category 1				123456	900-450/5	0.978	NA	Director/D	
B.3215	Central	KHANNA	11KV	DS DIVN. AMLDH	DS S/D SHAMSHPUR	D116FL13	Kanjari AP	AMR	OK	31.03.2023		AP 3Phase 3Wire				73153062	900-450/5	1.186	NA	Director/D	
B.3216	Central	KHANNA	11KV	DS DIVN. AMLDH	DS S/D SHAMSHPUR	D116FL03	Rajgarh Channa	AMR	OK	31.03.2023		AP 3Phase 3Wire				73152768	900-450/5	1.250	NA	Director/D	
B.3217	Central	KHANNA	11KV	DS DIVN. AMLDH	DS S/D SHAMSHPUR	kauligan AP	NON AMR	OK	31.03.2023		AP 3Phase 3Wire					73152693	900-450/5	1.445	NA	Director/D	
B.3218	Central	KHANNA	11KV	DS DIVN. AMLDH	DS S/D SHAMSHPUR	D116FL06	kauligan	AMR	OK	31.03.2023		AP 3Phase 3Wire				3064608	900-450/5	1.403	NA	Director/D	
B.3219	Central	KHANNA	11KV	DS DIVN. AMLDH	DS S/D SHAMSHPUR	D116FL09	Tangla	AMR	OK	31.03.2023		AP 3Phase 3Wire				7338805	900-450/5	1.555	NA	Director/D	
B.3220	Central	KHANNA	11KV	DS DIVN. AMLDH	DS S/D SHAMSHPUR	D116FL01	Lakha Singh wala	NON AMR	OK	31.03.2023		AP 3Phase 3Wire				9534392	900-450/5	1.556	NA	Director/D	
B.3221	Central	KHANNA	11KV	DS DIVN. AMLDH	DS S/D SHAMSHPUR	D116FL02	Shamshpur	AMR	OK	31.03.2023		AP 3Phase 3Wire				123456	900-450/5	1.817	NA	Director/D	
B.3222	Central	KHANNA	11KV	DS DIVN. AMLDH	DS S/D SHAMSHPUR	D116FL04	Mehmoondpur	AMR	OK	31.03.2023		AP 3Phase 3Wire				9534608	900-450/5	1.918	NA	Director/D	
B.3223	Central	KHANNA	11KV	DS DIVN. AMLDH	DS S/D SHAMSHPUR	D116FL05	kauligan	AMR	OK	31.03.2023		Category 5-UPS				5381130	900-450/5	7.243	NA	Director/D	
B.3224	Central	KHANNA	11KV	DS DIVN. AMLDH	DS S/D SHAMSHPUR	D117FL01	Phang	AMR	OK	31.03.2023		AP 3Phase 3Wire				125478	1200-600/5	1.294	NA	Director/D	
B.3225	Central	KHANNA	11KV	DS DIVN. AMLDH	DS S/D SHAMSHPUR	D117FL03	Tibbi	AMR	OK	31.03.2023		AP 3Phase 3Wire				9141078	1200-600/5	1.199	NA	Director/D	
B.3226	Central	KHANNA	11KV	DS DIVN. AMLDH	DS S/D SHAMSHPUR	D117FL16	BREEMA	AMR	OK	31.03.2023		AP 3Phase 3Wire				9154406	900-450/5	1.309	NA	Director/D	
B.3227	Central	KHANNA	11KV	DS DIVN. AMLDH	DS S/D SHAMSHPUR	D117FL08	Fatehpur	AMR	OK	31.03.2023		AP 3Phase 3Wire				5388134	900-450/5	1.951	NA	Director/D	
B.3228	Central	KHANNA	11KV	DS DIVN. AMLDH	DS S/D SHAMSHPUR	D117FL19	halla	AMR	OK	31.03.2023		AP 3Phase 3Wire				9154296	900-450/5	2.177	NA	Director/D	
B.3229	Central	KHANNA	11KV	DS DIVN. AMLDH	DS S/D SHAMSHPUR	D117FL05	Phang	AMR	OK	31.03.2023		AP 3Phase 3Wire				123456	900-450/5	2.202	NA	Director/D	
B.3230	Central	KHANNA	11KV	DS DIVN. AMLDH	DS S/D SHAMSHPUR	D117FL02	TANDA, BAOHA	AMR	OK	31.03.2023		AP 3Phase 3Wire				5341630	1200-600/5	2.298	NA	Director/D	
B.3231	Central	KHANNA	11KV	DS DIVN. AMLDH	DS S/D SHAMSHPUR	D117FL11	Kapoorghar	AMR	OK	31.03.2023		AP 3Phase 3Wire				2047194	1200-600/5	2.424	NA	Director/D	
B.3232	Central	KHANNA	11KV	DS DIVN. AMLDH	DS S/D SHAMSHPUR	D117FL14	MOPHAGOWARA	AMR	OK	31.03.2023		AP 3Phase 3Wire				9154296	1200-600/5	2.445	NA	Director/D	
B.3233	Central	KHANNA	11KV	DS DIVN. AMLDH	DS S/D SHAMSHPUR	D117FL18	11 KV KOTLI AP	AMR	OK	31.03.2023		AP 3Phase 3Wire				9144077	1200-600/5	2.535	NA	Director/D	
B.3234	Central	KHANNA	11KV	DS DIVN. AMLDH	DS S/D SHAMSHPUR	D117FL10	ChoddaranUPS	AMR	OK	31.03.2023		Category 5-UPS				9669394	1200-600/5	9.776	NA	Director/D	
B.3235	Central	KHANNA	11KV	DS DIVN. AMLDH	TOHRA	D113FL01	Highpur UPS	AMR	OK	31.03.2023		Category 5-UPS				124589	400-200/5-5	1.459	NA	Director/D	
B.3236	Central	KHANNA	11KV	DS DIVN. AMLDH	TOHRA	D118FL18	BEER MATA	AMR													

S.No	Zone	Circle	Voltage Level (kVA)	Division (kVA)	Sub-Division (kVA)	Feeder ID	Feeder Name	Feeder Metering Status (Metered/unmetered/AMR/AMI)	Status of Meter (Functional/Non-Functional)	Metering Date (Date of last actual meter reading/communication)	Feeder Type (Agr/Industrial/Mixed)	Status of Communication			Period from 01.04.2021 to 31.03.2022				Sales	Remarks (Source of data)
												% data received through automatically if feeder AMR/AMI	Number of hours when meter was unable to communicate in overall	Total Number of hours in the period	Meter S.No	CT/PT ratio	Import (kU)	Export (kU)		
B.3268	Central	KHANNA	11KV	DS DIVN. DORAHA	DS CITY S/D DORAHA	C101FL17	LONGOWALIAN	NON AMR	OK	31.03.2023	Category 4				5295687	1200-600/5	7.611	NA	Director/D	
B.3269	Central	KHANNA	11KV	DS DIVN. DORAHA	DS CITY S/D DORAHA	C101FL02	CITY DORAHA	NON AMR	OK	31.03.2023	Category 1				123456	1200-600/5	7.739	NA	Director/D	
B.3270	Central	KHANNA	11KV	DS DIVN. DORAHA	DS CITY S/D DORAHA	C101FL22	Dr. Somy Feeder	NON AMR	OK	31.03.2023	Category 1				123456	1200-600/5	9.029	NA	Director/D	
B.3271	Central	KHANNA	11KV	DS DIVN. DORAHA	DS CITY S/D DORAHA	C101FL16	INDUSTRIAL-II	AMR	OK	31.03.2023	Category 2				2067335	1200-600/5	9.031	NA	Director/D	
B.3272	Central	KHANNA	11KV	DS DIVN. DORAHA	DS CITY S/D DORAHA	C101FL19	Industrial-1	AMR	OK	31.03.2023	Category 2				124511	400-200/5-5	9.207	NA	Director/D	
B.3273	Central	KHANNA	11KV	DS DIVN. DORAHA	DS CITY S/D DORAHA	C101FL20	kumar Export	AMR	OK	31.03.2023	Category 2				4187868	1200-600/5	10.237	NA	Director/D	
B.3274	Central	KHANNA	11KV	DS DIVN. DORAHA	DS CITY S/D DORAHA	C101FL06	KADDON	AMR	OK	31.03.2023	Category 5-LUPS				5295717	1200-600/5	10.678	NA	Director/D	
B.3275	Central	KHANNA	11KV	DS DIVN. DORAHA	DS CITY S/D DORAHA	C101FL29	Best Steel	AMR	OK	31.03.2023	Category 2				215478	1200-600/5	12.222	NA	Director/D	
B.3276	Central	KHANNA	11KV	DS DIVN. DORAHA	DS CITY S/D DORAHA	C101FL08	B.T.C	AMR	OK	31.03.2023	Category 2				4187160	1200-600/5	13.665	NA	Director/D	
B.3277	Central	KHANNA	11KV	DS DIVN. DORAHA	DS CITY S/D DORAHA	C101FL05	GARG BEDI	AMR	OK	31.03.2023	Category 3				125478	400-200/5-5	17.458	NA	Director/D	
B.3278	Central	KHANNA	11KV	DS DIVN. DORAHA	DS CITY S/D DORAHA	C101FL04	OSWAL	AMR	OK	31.03.2023	Category 4				2068582	1200-600/5	18.735	NA	Director/D	
B.3279	Central	KHANNA	11KV	DS DIVN. DORAHA	DS CITY S/D DORAHA	T129FL14	Rekofa	AMR	OK	31.03.2023	Category 2				124566	900-450/577/1-1-1	0.188	NA	Director/D	
B.3280	Central	KHANNA	11KV	DS DIVN. DORAHA	DS CITY S/D DORAHA	T129FL12	Arora iron	AMR	OK	31.03.2023	Category 2				125874	900-450/577/1-1-1	3.031	NA	Director/D	
B.3281	Central	KHANNA	11KV	DS DIVN. DORAHA	DS CITY S/D DORAHA	T129FL01	Raison	AMR	OK	31.03.2023	Category 2				123456	900-450/577/1-1-1	6.988	NA	Director/D	
B.3282	Central	KHANNA	11KV	DS DIVN. DORAHA	DS CITY S/D DORAHA	T129FL10	Bull Forge	AMR	OK	31.03.2023	Category 2				125489	900-450/577/1-1-1	7.090	NA	Director/D	
B.3283	Central	KHANNA	11KV	DS DIVN. DORAHA	DS CITY S/D DORAHA	T129FL03	Despek Fastener	AMR	OK	31.03.2023	Category 2				123456	900-450/577/1-1-1	9.330	NA	Director/D	
B.3284	Central	KHANNA	11KV	DS DIVN. DORAHA	DS CITY S/D DORAHA	T129FL02	Coca Cola	NON AMR	OK	31.03.2023	Category 2				123456	900-450/577/1-1-1	13.727	NA	Director/D	
B.3285	Central	KHANNA	11KV	DS DIVN. DORAHA	DS CITY S/D DORAHA	D103FL12	D.F.L	AMR	OK	31.03.2023	Category 2				2072	1200-600/5	0.329	NA	Director/D	
B.3286	Central	KHANNA	11KV	DS DIVN. DORAHA	DS CITY S/D DORAHA	D103FL15	ARISUDANA	AMR	OK	31.03.2023	Category 2				2067363	1200-600/5	9.276	NA	Director/D	
B.3287	Central	KHANNA	11KV	DS DIVN. DORAHA	DS CITY S/D DORAHA	T130FL08	M/S Sam Solar Private Limited	AMR	OK	31.03.2023	Category 4				125478	900-450/577/1-1-1	0.024	NA	Director/D	
B.3288	Central	KHANNA	11KV	DS DIVN. DORAHA	DS CITY S/D DORAHA	T130FL20	SVM	AMR	OK	31.03.2023	Category 2				124589	400-200/5-5	0.093	NA	Director/D	
B.3289	Central	KHANNA	11KV	DS DIVN. DORAHA	DS CITY S/D DORAHA	T130FL13	Durgt	AMR	OK	31.03.2023	AP 3Phase 3Wire				125489	900-450/577/1-1-1	0.871	NA	Director/D	
B.3290	Central	KHANNA	11KV	DS DIVN. DORAHA	DS CITY S/D DORAHA	T129FL07	HOTI MARDAN	AMR	OK	31.03.2023	AP 3Phase 3Wire				1256478	900-450/577/1-1-1	2.131	NA	Director/D	
B.3291	Central	KHANNA	11KV	DS DIVN. DORAHA	DS CITY S/D DORAHA	T129FL05	Ajodhd	AMR	OK	31.03.2023	Category 5-LUPS				125698	900-450/577/1-1-1	2.894	NA	Director/D	
B.3292	Central	KHANNA	11KV	DS DIVN. DORAHA	DS CITY S/D DORAHA	T129FL04	Doburi	AMR	OK	31.03.2023	Category 1				216547	900-450/577/1-1-1	3.025	NA	Director/D	
B.3293	Central	KHANNA	11KV	DS DIVN. DORAHA	DS CITY S/D DORAHA	T130FL07	Rachna Fastner	AMR	OK	31.03.2023	Category 2				124589	900-450/577/1-1-1	6.831	NA	Director/D	
B.3294	Central	KHANNA	11KV	DS DIVN. DORAHA	DS CITY S/D DORAHA	T130FL19	HARTEX RUBBER	AMR	OK	31.03.2023	Category 4				125478	400-200/5-5	8.156	NA	Director/D	
B.3295	Central	KHANNA	11KV	DS DIVN. DORAHA	DS CITY S/D DORAHA	T130FL12	Sohki	AMR	OK	31.03.2023	Category 2				123456	900-450/577/1-1-1	9.907	NA	Director/D	
B.3296	Central	KHANNA	11KV	DS DIVN. DORAHA	DS CITY S/D DORAHA	T130FL15	Ajar Amar Steel	NON AMR	OK	31.03.2023	Category 2				125487	400-200/5-5	12.361	NA	Director/D	
B.3297	Central	KHANNA	11KV	DS DIVN. DORAHA	DS CITY S/D DORAHA	T130FL11	Vasu Multimetel	Not available	OK	31.03.2023	Category 2				123456	900-450/577/1-1-1	24.283	NA	Director/D	
B.3298	Central	KHANNA	11KV	DS DIVN. DORAHA	DS CITY S/D DORAHA	T129FL11	HARTEX RUBBER	Not available	OK	31.03.2023	Category 2				Not available	Not available	0.803	NA	Director/D	
B.3299	Central	KHANNA	11KV	DS DIVN. DORAHA	DS CITY S/D DORAHA	C101FL21	Seeko Strip	Not available	OK	31.03.2023	Category 2				Not available	Not available	7.385	NA	Director/D	
B.3300	Central	KHANNA	66KV	DS DIVN. DORAHA	DS CITY S/D DORAHA	D103I022	RALSON	Not available	OK	31.03.2023	Category 2				Not available	Not available	12.356	NA	Director/D	
B.3301	Central	KHANNA	66KV	DS DIVN. DORAHA	DS CITY S/D DORAHA	D103I020	KAUR SAIN	Not available	OK	31.03.2023	Category 4				Not available	Not available	19.050	NA	Director/D	
B.3302	Central	KHANNA	66KV	DS DIVN. DORAHA	DS CITY S/D DORAHA	T130D050	Happy Forging	Not available	OK	31.03.2023	Category 2				Not available	Not available	19.939	NA	Director/D	
B.3303	Central	KHANNA	66KV	DS DIVN. DORAHA	DS CITY S/D DORAHA	C101D010	STELCO	AMR	OK	31.03.2023	Category 4				Not available	Not available	102.187	NA	Director/D	
B.3304	Central	KHANNA	11KV	DS DIVN. DORAHA	DS S/D DHAMOTE	C103FL09	SHORCA UPS	AMR	OK	31.03.2023	AP 3Phase 3Wire				8223260	1200-600/5	2.243	NA	Director/D	
B.3305	Central	KHANNA	11KV	DS DIVN. DORAHA	DS S/D DHAMOTE	C103FL08	BHADDEWAL	AMR	OK	31.03.2023	AP 3Phase 3Wire				9140961	1200-600/5	2.511	NA	Director/D	
B.3306	Central	KHANNA	11KV	DS DIVN. DORAHA	DS S/D DHAMOTE	C103FL12	Chapra	AMR	OK	31.03.2023	AP 3Phase 3Wire				1027352	1200-600/5	2.584	NA	Director/D	
B.3307	Central	KHANNA	11KV	DS DIVN. DORAHA	DS S/D DHAMOTE	C103FL14	BABARPUR	AMR	OK	31.03.2023	AP 3Phase 3Wire				124589	400-200/5-5	2.619	NA	Director/D	
B.3308	Central	KHANNA	11KV	DS DIVN. DORAHA	DS S/D DHAMOTE	C103FL10	SHORCA CT-1	AMR	OK	31.03.2023	Category 1				7336381	1200-600/5	2.736	NA	Director/D	
B.3309	Central	KHANNA	11KV	DS DIVN. DORAHA	DS S/D DHAMOTE	C103FL13	Jandhi	AMR	OK	31.03.2023	AP 3Phase 3Wire				121854	400-200/5-5	2.759	NA	Director/D	
B.3310	Central	KHANNA	11KV	DS DIVN. DORAHA	DS S/D DHAMOTE	C103FL07	MAONPUR	AMR	OK	31.03.2023	AP 3Phase 3Wire				8223252	1200-600/5	2.769	NA	Director/D	
B.3311	Central	KHANNA	11KV	DS DIVN. DORAHA	DS S/D DHAMOTE	C103FL01	Dhamot	AMR	OK	31.03.2023	AP 3Phase 3Wire				9140965	1200-600/5	2.796	NA	Director/D	
B.3312	Central	KHANNA	11KV	DS DIVN. DORAHA	DS S/D DHAMOTE	C103FL11	Ramsar	AMR	OK	31.03.2023	AP 3Phase 3Wire				1245698	400-200/5-5	2.883	NA	Director/D	
B.3313	Central	KHANNA	11KV	DS DIVN. DORAHA	DS S/D DHAMOTE	C103FL06	KUHU	AMR	OK	31.03.2023	AP 3Phase 3Wire				8222510	1200-600/5	3.233	NA	Director/D	
B.3314	Central	KHANNA	11KV	DS DIVN. DORAHA	DS S/D DHAMOTE	C103FL03	NIZAMPUR	AMR	OK	31.03.2023	AP 3Phase 3Wire				9140962	1200-600/5	3.378	NA	Director/D	
B.3315	Central	KHANNA	11KV	DS DIVN. DORAHA	DS S/D DHAMOTE	C103FL04	SHORCA UPS	AMR	OK	31.03.2023	Category 5-LUPS				124589	1200-600/5	3.656	NA	Director/D	
B.3316	Central	KHANNA	11KV	DS DIVN. DORAHA	DS S/D DHAMOTE	C103FL08	DHAMOT UPS	AMR	OK	31.03.2023	Category 5-LUPS				123456	400-200/5-5	9.573	NA	Director/D	
B.3317	Central	KHANNA	11KV	DS DIVN. DORAHA	DS S/D DHAMOTE	D102FL02	JARGARI	AMR	OK	31.03.2023	AP 3Phase 3Wire				8223485	1200-600/5	2.157	NA	Director/D	
B.3318	Central	KHANNA	11KV	DS DIVN. DORAHA	DS S/D DHAMOTE	D102FL09	NIZAMPUR	AMR	OK	31.03.2023	AP 3Phase 3Wire				5341628	1200-600/5	2.320	NA	Director/D	
B.3319	Central	KHANNA	11KV	DS DIVN. DORAHA	DS S/D DHAMOTE	D064FL03	LEHAL	NON AMR	OK	31.03.2023	AP 3Phase 3Wire				8223032	1200/577/1-1-1	1.876	NA	Director/D	
B.3320	Central	KHANNA	11KV	DS DIVN. DORAHA	DS S/D GHUDANI KALAN	C102FL04	GHUDANI KALAN-I	AMR	OK	31.03.2023	AP 3Phase 3Wire				123456	900-450/577/1-1-1	1.701	NA	Director/D	
B.3321	Central	KHANNA	11KV	DS DIVN. DORAHA	DS S/D GHUDANI KALAN	C102FL13	GHUDANI KALAN-II	AMR	OK	31.03.2023	AP 3Phase 3Wire				123456	900-450/577/1-1-1	2.075	NA	Director/D	
B.3322	Central	KHANNA	11KV	DS DIVN. DORAHA	DS S/D GHUDANI KALAN	C102FL01	RAKA SAHIB	AMR	OK	31.03.2023	AP 3Phase 3Wire				8222527	900-450/5-5	2.452	NA	Director/D	
B.3323	Central	KHANNA	11KV	DS DIVN. DORAHA	DS S/D GHUDANI KALAN	C102FL02	Ippan	NON AMR	OK	31.03.2023	AP 3Phase 3Wire				8223787	900-450/5-5	2.487	NA	Director/D	
B.3324	Central	KHANNA	11KV	DS DIVN. DORAHA	DS S/D GHUDANI KALAN	C102FL07	GHUDANI KALAN-II	AMR	OK	31.03.2023	AP 3Phase 3Wire				123456	900-450/577/1-1-1	2.531	NA	Director/D	
B.3325	Central	KHANNA	11KV	DS DIVN. DORAHA	DS S/D GHUDANI KALAN	C102FL05	BIJASPUR	NON AMR	OK	31.03.2023	Category 1				8222508	900-450/5-5	2.898	NA	Director/D	
B.3326	Central	KHANNA	11KV	DS DIVN. DORAHA	DS S/D GHUDANI KALAN	C102FL06	KANAI	AMR	OK	31.03.2023	Category 5-LUPS				123456	900-450/577/1-1-1	5.184	NA	Director/D	
B.3327	Central	KHANNA	11KV	DS DIVN. DORAHA	DS S/D GHUDANI KALAN	C102FL09	LANDNA BOWANI													

S.No	Zone	Circle	Voltage Level (kVA)	Division (kVA)	Sub-Division (kVA)	Feeder ID	Feeder Name	Feeder Metering Status (Metered/unmetered/AMR/AM)	Status of Meter (Functional/Non-Functional)	Metering Date (Date of last actual meter reading/communication)	Feeder Type (Agr/Industrial/Mixed)	Status of Communication			Period from 01.04.2021 to 31.03.2022				Sales	Remarks (Source of data)
												% data received through automatically by feeder AMR/AM	Number of hours when meter was unable to communicate in overall	Total Number of hours in the period	Meter S.No	CT/PT ratio	Import (kU)	Export (kU)		
B.3365	Central	KHANNA	11KV	DS DIVN. KHANNA	DS CTY-1 S/D KHANNA	D010FL05	Markfed	AMR	OK	31.03.2023	Category 2				6679868	1200-600/5	0.641	NA	Director/D	
B.3366	Central	KHANNA	11KV	DS DIVN. KHANNA	DS CTY-1 S/D KHANNA	D010FL19	Mil 2	AMR	OK	31.03.2023	Category 2				2068127	1200-600/5	1.855	NA	Director/D	
B.3367	Central	KHANNA	11KV	DS DIVN. KHANNA	DS CTY-1 S/D KHANNA	D010FL02	Rahon	AMR	OK	31.03.2023	AP 3Phase 3Wire				1028349	900-450/577/1-1-1	3.473	NA	Director/D	
B.3368	Central	KHANNA	11KV	DS DIVN. KHANNA	DS CTY-1 S/D KHANNA	D010FL09	Samadh Road	AMR	OK	31.03.2023	Category 1				1214456	900-450/577/1-1-1	4.101	NA	Director/D	
B.3369	Central	KHANNA	11KV	DS DIVN. KHANNA	DS CTY-1 S/D KHANNA	D010FL03	Mil 1	AMR	OK	31.03.2023	Category 2				6740949	1200-600/5	6.796	NA	Director/D	
B.3370	Central	KHANNA	11KV	DS DIVN. KHANNA	DS CTY-1 S/D KHANNA	D010FL26	LALHER ROAD	AMR	OK	31.03.2023	Category 1				125687	400-200/5-5	7.133	NA	Director/D	
B.3371	Central	KHANNA	11KV	DS DIVN. KHANNA	DS CTY-1 S/D KHANNA	D010FL08	City 1	AMR	OK	31.03.2023	Category 1				125478	400-200/5-5	8.756	NA	Director/D	
B.3372	Central	KHANNA	11KV	DS DIVN. KHANNA	DS CTY-1 S/D KHANNA	D010FL25	Jagat Colony	AMR	OK	31.03.2023	Category 1				125478	400-200/5-5	8.858	NA	Director/D	
B.3373	Central	KHANNA	11KV	DS DIVN. KHANNA	DS CTY-1 S/D KHANNA	D010FL07	Focal Point 2	NON AMR	OK	31.03.2023	Category 2				8223345	900-450/577/1-1-1	9.963	NA	Director/D	
B.3374	Central	KHANNA	11KV	DS DIVN. KHANNA	DS CTY-1 S/D KHANNA	D010FD21	Shiv Shakti	AMR	OK	31.03.2023	Category 3				1028349	1200-600/5	10.191	NA	Director/D	
B.3375	Central	KHANNA	11KV	DS DIVN. KHANNA	DS CTY-1 S/D KHANNA	D010FL18	Focal Point 1	AMR	OK	31.03.2023	Category 2				5343291	1200-600/5	11.783	NA	Director/D	
B.3376	Central	KHANNA	11KV	DS DIVN. KHANNA	DS CTY-1 S/D KHANNA	D010FL15	Nandi Colony	AMR	OK	31.03.2023	Category 1				6489726	1200-600/5	13.129	NA	Director/D	
B.3377	Central	KHANNA	11KV	DS DIVN. KHANNA	DS CTY-1 S/D KHANNA	D010FL04	Sarnala Road	AMR	OK	31.03.2023	Category 1				7336494	1200-600/5	18.613	NA	Director/D	
B.3378	Central	KHANNA	11KV	DS DIVN. KHANNA	DS CTY-1 S/D KHANNA	D010FL20	Jai Bhatt	AMR	OK	31.03.2023	Category 3				1028349	1200-600/5	35.398	NA	Director/D	
B.3379	Central	KHANNA	11KV	DS DIVN. KHANNA	DS CTY-2 S/D KHANNA	D010FL12	Jai Sath Yogi	AMR	OK	31.03.2023	Category 2				2068587	1200-600/5	4.050	NA	Director/D	
B.3380	Central	KHANNA	11KV	DS DIVN. KHANNA	DS CTY-2 S/D KHANNA	D010FL22	11 KV Kmbuja Colony	AMR	OK	31.03.2023	Category 1				124785	900-450/577/1-1-1	0.853	NA	Director/D	
B.3381	Central	KHANNA	11KV	DS DIVN. KHANNA	DS CTY-2 S/D KHANNA	D010FL05	Gaiwadi	AMR	OK	31.03.2023	AP 3Phase 3Wire				2068871	900-450/577/1-1-1	1.869	NA	Director/D	
B.3382	Central	KHANNA	11KV	DS DIVN. KHANNA	DS CTY-2 S/D KHANNA	D010FL19	A.R. Pipe	AMR	OK	31.03.2023	Category 2				9154205	1200-600/5	3.052	NA	Director/D	
B.3383	Central	KHANNA	11KV	DS DIVN. KHANNA	DS CTY-2 S/D KHANNA	D010FL02	PS	AMR	OK	31.03.2023	Category 2				8222882	1200-600/5	4.307	NA	Director/D	
B.3384	Central	KHANNA	11KV	DS DIVN. KHANNA	DS CTY-2 S/D KHANNA	D010FL03	TI feeder	AMR	OK	31.03.2023	Category 2				9154204	1200-600/5	5.289	NA	Director/D	
B.3385	Central	KHANNA	11KV	DS DIVN. KHANNA	DS CTY-2 S/D KHANNA	D010FL09	Rainmond	AMR	OK	31.03.2023	Category 2				2058865	1200-600/5	6.094	NA	Director/D	
B.3386	Central	KHANNA	11KV	DS DIVN. KHANNA	DS CTY-2 S/D KHANNA	D010FL17	Neeekanth	AMR	OK	31.03.2023	Category 3				125487	1200-600/5	6.463	NA	Director/D	
B.3387	Central	KHANNA	11KV	DS DIVN. KHANNA	DS CTY-2 S/D KHANNA	D010FL20	ISM	AMR	OK	31.03.2023	Category 2				11116896	900-450/577/1-1-1	7.568	NA	Director/D	
B.3388	Central	KHANNA	11KV	DS DIVN. KHANNA	DS CTY-2 S/D KHANNA	D010FL08	Bhanra	AMR	OK	31.03.2023	Category 2				9154254	1200-600/5	7.667	NA	Director/D	
B.3389	Central	KHANNA	11KV	DS DIVN. KHANNA	DS CTY-2 S/D KHANNA	D010FL14	Satsahb	AMR	OK	31.03.2023	Category 2				8222861	1200-600/5	8.831	NA	Director/D	
B.3390	Central	KHANNA	11KV	DS DIVN. KHANNA	DS CTY-2 S/D KHANNA	D010FL12	APS	NON AMR	OK	31.03.2023	Category 2				9141126	1200-600/5	11.263	NA	Director/D	
B.3391	Central	KHANNA	11KV	DS DIVN. KHANNA	DS CTY-2 S/D KHANNA	D010FL25	Narian and CO.	AMR	OK	31.03.2023	Category 3				11116896	1200-600/5	17.241	NA	Director/D	
B.3392	Central	KHANNA	11KV	DS DIVN. KHANNA	DS CTY-2 S/D KHANNA	D010FL24	RP CONCAST	AMR	OK	31.03.2023	Category 3				125478	900-450/577/1-1-1	26.891	NA	Director/D	
B.3393	Central	KHANNA	11KV	DS DIVN. KHANNA	DS CTY-2 S/D KHANNA	D010FL09	ICI	AMR	OK	31.03.2023	Category 1				125478	1200-600/5	4.752	NA	Director/D	
B.3394	Central	KHANNA	11KV	DS DIVN. KHANNA	DS CTY-2 S/D KHANNA	D010FL21	City Centre	AMR	OK	31.03.2023	Category 1				9141096	1200-600/5	0.522	NA	Director/D	
B.3395	Central	KHANNA	11KV	DS DIVN. KHANNA	DS CTY-2 S/D KHANNA	D010FL14	Hospital	AMR	OK	31.03.2023	Category 4				6740773	1200-800/5	0.976	NA	Director/D	
B.3396	Central	KHANNA	11KV	DS DIVN. KHANNA	DS CTY-2 S/D KHANNA	D010FL16	Friend colony	AMR	OK	31.03.2023	Category 1				6740303	1200-600/5	6.493	NA	Director/D	
B.3397	Central	KHANNA	11KV	DS DIVN. KHANNA	DS CTY-2 S/D KHANNA	D010FL01	Khanna feeder	AMR	OK	31.03.2023	Category 1				12466066	900-450/577/1-1-1	8.523	NA	Director/D	
B.3398	Central	KHANNA	11KV	DS DIVN. KHANNA	DS CTY-2 S/D KHANNA	D010FL28	Krishna Nagar	AMR	OK	31.03.2023	Category 1				125474	400-200/5-5	8.692	NA	Director/D	
B.3399	Central	KHANNA	11KV	DS DIVN. KHANNA	DS CTY-2 S/D KHANNA	D010FL12	Amlioh Road	AMR	OK	31.03.2023	Category 1				7336424	1200-600/5	9.924	NA	Director/D	
B.3400	Central	KHANNA	11KV	DS DIVN. KHANNA	DS CTY-2 S/D KHANNA	D010FL23	DEVI DAWALA Feeder	AMR	OK	31.03.2023	Category 1				2068680	1200-600/5	11.680	NA	Director/D	
B.3401	Central	KHANNA	11KV	DS DIVN. KHANNA	DS CTY-2 S/D KHANNA	D010FL10	Bhuttan	AMR	OK	31.03.2023	Category 1				124987	1200-600/5	13.693	NA	Director/D	
B.3402	Central	KHANNA	11KV	DS DIVN. KHANNA	DS CTY-2 S/D KHANNA	D010FL13	City-2 khanna	AMR	OK	31.03.2023	Category 1				7042974	1200-600/5	15.182	NA	Director/D	
B.3403	Central	KHANNA	11KV	DS DIVN. KHANNA	DS S/D BHARI	FT01FL09	Barwall Lehi	NON AMR	OK	31.03.2023	AP 3Phase 3Wire				125847	900-450/577/1-1-1	2.088	NA	Director/D	
B.3404	Central	KHANNA	11KV	DS DIVN. KHANNA	DS S/D BHARI	FT01FL04	Barwall	AMR	OK	31.03.2023	AP 3Phase 3Wire				7042870	1200-600/5	2.262	NA	Director/D	
B.3405	Central	KHANNA	11KV	DS DIVN. KHANNA	DS S/D BHARI	D010FL21	220 KV Transco	NON AMR	OK	31.03.2023	Category 4				124783	900-450/5	0.081	NA	Director/D	
B.3406	Central	KHANNA	11KV	DS DIVN. KHANNA	DS S/D BHARI	D010FL20	MAHON	AMR	OK	31.03.2023	AP 3Phase 3Wire				11116840	900-450/5	2.087	NA	Director/D	
B.3407	Central	KHANNA	11KV	DS DIVN. KHANNA	DS S/D BHARI	D010FL09	Loharnajra	AMR	OK	31.03.2023	AP 3Phase 3Wire				2068680	900-450/5	2.150	NA	Director/D	
B.3408	Central	KHANNA	11KV	DS DIVN. KHANNA	DS S/D BHARI	D010FL17	11 KV MIRPUR	AMR	OK	31.03.2023	AP 3Phase 3Wire				124789	1200/577/1-1-1	2.322	NA	Director/D	
B.3409	Central	KHANNA	11KV	DS DIVN. KHANNA	DS S/D BHARI	D010FL11	harion	AMR	OK	31.03.2023	AP 3Phase 3Wire				8223564	1200-600/5	2.637	NA	Director/D	
B.3410	Central	KHANNA	11KV	DS DIVN. KHANNA	DS S/D BHARI	D010FL15	RAMGARH	AMR	OK	31.03.2023	AP 3Phase 3Wire				1245599	1200/577/1-1-1	2.652	NA	Director/D	
B.3411	Central	KHANNA	11KV	DS DIVN. KHANNA	DS S/D BHARI	D010FL08	Malikpur	AMR	OK	31.03.2023	AP 3Phase 3Wire				8422421	900-450/5	2.807	NA	Director/D	
B.3412	Central	KHANNA	11KV	DS DIVN. KHANNA	DS S/D BHARI	D010FL14	Chakoh-I	AMR	OK	31.03.2023	AP 3Phase 3Wire				1246354	1200/577/1-1-1	2.827	NA	Director/D	
B.3413	Central	KHANNA	11KV	DS DIVN. KHANNA	DS S/D BHARI	D010FL12	Thikwal	AMR	OK	31.03.2023	AP 3Phase 3Wire				8222894	1200-600/5	2.829	NA	Director/D	
B.3414	Central	KHANNA	11KV	DS DIVN. KHANNA	DS S/D BHARI	D010FL05	Sahibpur	AMR	OK	31.03.2023	AP 3Phase 3Wire				8223343	1200-600/5	2.894	NA	Director/D	
B.3415	Central	KHANNA	11KV	DS DIVN. KHANNA	DS S/D BHARI	D010FL04	Bhari	AMR	OK	31.03.2023	AP 3Phase 3Wire				8222422	1200-600/5	2.928	NA	Director/D	
B.3416	Central	KHANNA	11KV	DS DIVN. KHANNA	DS S/D BHARI	D010FL07	Goslan	AMR	OK	31.03.2023	AP 3Phase 3Wire				4187172	1200-600/5	2.976	NA	Director/D	
B.3417	Central	KHANNA	11KV	DS DIVN. KHANNA	DS S/D BHARI	D010FL02	Manupur	AMR	OK	31.03.2023	AP 3Phase 3Wire				2068744	1200-600/5	2.993	NA	Director/D	
B.3418	Central	KHANNA	11KV	DS DIVN. KHANNA	DS S/D BHARI	D010FL03	Rohar	AMR	OK	31.03.2023	AP 3Phase 3Wire				2068703	900-450/5	3.111	NA	Director/D	
B.3419	Central	KHANNA	11KV	DS DIVN. KHANNA	DS S/D BHARI	D010FL01	Musaffabad	AMR	OK	31.03.2023	AP 3Phase 3Wire				125698	1200/577/1-1-1	3.170	NA	Director/D	
B.3420	Central	KHANNA	11KV	DS DIVN. KHANNA	DS S/D BHARI	D010FL22	Badla	AMR	OK	31.03.2023	Category 1				8222423	1200-600/5	4.292	NA	Director/D	
B.3421	Central	KHANNA	11KV	DS DIVN. KHANNA	DS S/D BHARI	D010FL06	Laheri city	AMR	OK	31.03.2023	Category 5-UPS				2067347	1200-600/5	7.296	NA	Director/D	
B.3422	Central	KHANNA	11KV	DS DIVN. KHANNA	DS S/D BHARI	D010FL23	Ismailpur feeder	AMR	OK	31.03.2023	Category 1				124589	1200/577/1-1-1	9.091	NA	Director/D	
B.3423	Central	KHANNA	11KV	DS DIVN. KHANNA	DS S/D BHARI	D010FL13	Beval Concast	AMR	OK	31.03.2023	Category 5-UPS				2067310	900-450/5	13.693	NA	Director/D	
B.3424	Central	KHANNA	11KV	DS DIVN. KHANNA	DS S/D BHARI	D010FL16	A.R. CONCAST	AMR	OK	31.03.2023	Category 3				125462	1200/577/1-1-1	10.241	NA	Director/D	
B.3425	Central	KHANNA	11KV	DS DIVN. KHANNA	DS S/D BHARI	D010FL10	Kotla bhari	NON AMR	OK	31.03.2023	Category 5-UPS				2067147	900-450/5	11.938	NA	Director/D	
B.3426	Central	KHANNA	11KV	DS DIVN. KHANNA	DS S/D BHARI	D010FL1	S.B.J. Alloys	NON AMR	OK	31.03.2023	Category 3				1114477	900-450/5	16.626	NA	Director/D	
B.3427	Central	KHANNA	11KV	DS DIVN. KHANNA	DS S/D BHARI	D011FL15	Garg	AMR	OK	31.03.2023	Category 4				9154273	1200-600/5	0.000	NA	Director/D	
B.3428	Central	KHANNA	11KV	DS DIVN. KHANNA	DS S/D BHARI	D011FL13	manakmajra	AMR	OK	31.03.2023	AP 3Phase 3Wire				123458	400-200/5-5	3.522	NA	Director/D	
B.3429	Central	KHANNA	11KV	DS DIVN. KHANNA	DS S/D BHARI	D011FL19	Sanjivpur	AMR	OK	31.03.2023	Category 3				125478	400-200/5-5	9.082	NA	Director/D	
B.3430	Central	KHANNA	11KV	DS DIVN. KHANNA	DS S/D BHARI	D011FL17	Allwar Alloys	NON AMR	OK	31.03.2023	Category 3				6489719	1200-600/5	18.090	NA	Director/D	
B.3431	Central	KHANNA	11KV	DS DIVN. KHANNA	DS S/D BHARI	D011FL16	Vish													

S.No	Zone	Circle	Voltage Level (kVA)	Division (kVA)	Sub-Division (kVA)	Feeder ID	Feeder Name	Feeder Metering Status (Metered/unmetered/AMR/AMI)	Status of Meter (Functional/Non-Functional)	Metering Date (Date of last actual meter reading/communication)	Feeder Type (Agr./Industrial/Mixed)	Status of Communication			Period from 01.04.2021 to 31.03.2022				Sales	Remarks (Source of data)
												% data received through automatically if feeder AMR/AMI	Number of hours when meter was unable to communicate in overall	Total Number of hours in the period	Meter S.No	CT/PT ratio	Import (kU)	Export (kU)		
B.3462	Central	KHANNA	11KV	DS DIVN. KHANNA	DS S/D JARG	D0202FL22	ISSRU CITY	AMR	OK	31.03.2023	Category 1				125477	400-200/5-5	0.042	NA	Director/D	
B.3463	Central	KHANNA	11KV	DS DIVN. KHANNA	DS S/D JARG	D0202FL07	Jarg	AMR	OK	31.03.2023	AP 3Phase 3Wire				5388145	1200-600/5	1.717	NA	Director/D	
B.3464	Central	KHANNA	11KV	DS DIVN. KHANNA	DS S/D JARG	D0202FL18	Mander	AMR	OK	31.03.2023	AP 3Phase 3Wire				1234456	1200-600/5	1.948	NA	Director/D	
B.3465	Central	KHANNA	11KV	DS DIVN. KHANNA	DS S/D JARG	D0202FL05	Nasari	AMR	OK	31.03.2023	AP 3Phase 3Wire				5346161	400-200/5-5	2.132	NA	Director/D	
B.3466	Central	KHANNA	11KV	DS DIVN. KHANNA	DS S/D JARG	D0202FL17	deeva gandaan	AMR	OK	31.03.2023	AP 3Phase 3Wire				124879	400-200/5-5	2.430	NA	Director/D	
B.3467	Central	KHANNA	11KV	DS DIVN. KHANNA	DS S/D JARG	D0202FL11	Beepur	AMR	OK	31.03.2023	AP 3Phase 3Wire				8223676	1200-600/5	2.511	NA	Director/D	
B.3468	Central	KHANNA	11KV	DS DIVN. KHANNA	DS S/D JARG	D0202FL16	Malakpur	AMR	OK	31.03.2023	AP 3Phase 3Wire				124788	400-200/5-5	2.593	NA	Director/D	
B.3469	Central	KHANNA	11KV	DS DIVN. KHANNA	DS S/D JARG	D0202FL08	Tumari	AMR	OK	31.03.2023	AP 3Phase 3Wire				125488	400-200/5-5	2.846	NA	Director/D	
B.3470	Central	KHANNA	11KV	DS DIVN. KHANNA	DS S/D JARG	D0202FL15	Iulamgah	AMR	OK	31.03.2023	AP 3Phase 3Wire				125479	400-200/5-5	2.869	NA	Director/D	
B.3471	Central	KHANNA	11KV	DS DIVN. KHANNA	DS S/D JARG	D0202FL14	Fatehpur	AMR	OK	31.03.2023	AP 3Phase 3Wire				124783	400-200/5-5	3.027	NA	Director/D	
B.3472	Central	KHANNA	11KV	DS DIVN. KHANNA	DS S/D JARG	D0202FL12	Rauni	AMR	OK	31.03.2023	AP 3Phase 3Wire				8223680	1200-600/5	3.039	NA	Director/D	
B.3473	Central	KHANNA	11KV	DS DIVN. KHANNA	DS S/D JARG	D0202FL06	Ladewal	AMR	OK	31.03.2023	AP 3Phase 3Wire				7336378	1200-600/5	3.049	NA	Director/D	
B.3474	Central	KHANNA	11KV	DS DIVN. KHANNA	DS S/D JARG	D0202FL01	Rohno	AMR	OK	31.03.2023	AP 3Phase 3Wire				7336452	1200-600/5	3.167	NA	Director/D	
B.3475	Central	KHANNA	11KV	DS DIVN. KHANNA	DS S/D JARG	D0202FL04	Sirhala	AMR	OK	31.03.2023	AP 3Phase 3Wire				8223679	1200-600/5	3.234	NA	Director/D	
B.3477	Central	KHANNA	11KV	DS DIVN. KHANNA	DS S/D JARG	D0202FL03	Urban	AMR	OK	31.03.2023	Category 1				1234456	1200-600/5	5.494	NA	Director/D	
B.3478	Central	KHANNA	11KV	DS DIVN. KHANNA	DS S/D JARG	D0202FL13	lalajan	NON AMR	OK	31.03.2023	Category 1				8223679	1200-600/5	10.838	NA	Director/D	
B.3479	Central	KHANNA	11KV	DS DIVN. KHANNA	DS S/D JARG	X0202FL9	Dhromajra	NON AMR	OK	31.03.2023	AP 3Phase 3Wire				36823	900-450/5/7/1-1	1.858	NA	Director/D	
B.3480	Central	KHANNA	11KV	DS DIVN. KHANNA	DS S/D JARG	B0202FL13	Canal Side	AMR	OK	31.03.2023	AP 3Phase 3Wire				1234456	900-450/5	1.994	NA	Director/D	
B.3481	Central	KHANNA	11KV	DS DIVN. KHANNA	DS S/D JARG	B0202FL18	BACHOUR	AMR	OK	31.03.2023	Category 5-U/PS				124587	900-450/5	2.272	NA	Director/D	
B.3482	Central	KHANNA	11KV	DS DIVN. KHANNA	DS S/D JARG	B0202FL16	First Reliable	AMR	OK	31.03.2023	Category 3				124785	900-450/5	2.397	NA	Director/D	
B.3483	Central	KHANNA	11KV	DS DIVN. KHANNA	DS S/D JARG	B0202FL09	NARAINGARH	AMR	OK	31.03.2023	AP 3Phase 3Wire				8223383	900-450/5	2.426	NA	Director/D	
B.3484	Central	KHANNA	11KV	DS DIVN. KHANNA	DS S/D JARG	B0202FL03	RAJEWAL	AMR	OK	31.03.2023	AP 3Phase 3Wire				8223385	900-450/5	2.507	NA	Director/D	
B.3485	Central	KHANNA	11KV	DS DIVN. KHANNA	DS S/D JARG	B0202FL14	Kanna	AMR	OK	31.03.2023	Category 5-U/PS				1234456	900-450/5	2.543	NA	Director/D	
B.3486	Central	KHANNA	11KV	DS DIVN. KHANNA	DS S/D JARG	B0202FL15	Himatgah	AMR	OK	31.03.2023	AP 3Phase 3Wire				568474	900-450/5	2.624	NA	Director/D	
B.3487	Central	KHANNA	11KV	DS DIVN. KHANNA	DS S/D JARG	B0202FL02	KAL MAIRA	AMR	OK	31.03.2023	AP 3Phase 3Wire				8140663	900-450/5	2.696	NA	Director/D	
B.3488	Central	KHANNA	11KV	DS DIVN. KHANNA	DS S/D JARG	B0202FL04	RATAN PALON	NON AMR	OK	31.03.2023	AP 3Phase 3Wire				7336667	900-450/5	2.698	NA	Director/D	
B.3489	Central	KHANNA	11KV	DS DIVN. KHANNA	DS S/D JARG	B0202FL12	Chashma Sahib	AMR	OK	31.03.2023	AP 3Phase 3Wire				1234456	900-450/5	2.713	NA	Director/D	
B.3490	Central	KHANNA	11KV	DS DIVN. KHANNA	DS S/D JARG	B0202FL17	Godrej	AMR	OK	31.03.2023	Category 4				0	900-450/5	3.361	NA	Director/D	
B.3491	Central	KHANNA	11KV	DS DIVN. KHANNA	DS S/D JARG	B0202FL01	FAIZGARH	NON AMR	OK	31.03.2023	AP 3Phase 3Wire				7042988	900-450/5	3.510	NA	Director/D	
B.3492	Central	KHANNA	11KV	DS DIVN. KHANNA	DS S/D JARG	B0202FL05	URBAN	AMR	OK	31.03.2023	Category 1				5388144	900-450/5	5.013	NA	Director/D	
B.3493	Central	KHANNA	11KV	DS DIVN. KHANNA	DS S/D JARG	B0202FL08	RONDH	AMR	OK	31.03.2023	Category 5-U/PS				5388126	900-450/5	6.392	NA	Director/D	
B.3494	Central	KHANNA	11KV	DS DIVN. KHANNA	DS S/D JARG	B0202FL07	IKOLAHA	AMR	OK	31.03.2023	Category 2				2066811	900-450/5	14.136	NA	Director/D	
B.3495	Central	KHANNA	11KV	DS DIVN. KHANNA	DS S/D JARG	D0204FL21	Salana Dara Singh Wala	AMR	OK	31.03.2023	AP 3Phase 3Wire				1234456	900-450/5/7/1-1	2.073	NA	Director/D	
B.3496	Central	KHANNA	11KV	DS DIVN. KHANNA	DS S/D JARG	D0204FL06	SALANA UPS	AMR	OK	31.03.2023	Category 5-U/PS				8222881	1200-600/5	8.124	NA	Director/D	
B.3497	Central	KHANNA	11KV	DS DIVN. KHANNA	DS S/D JARG	D0212FL05	RASULARA	AMR	OK	31.03.2023	AP 3Phase 3Wire				9154370	1200-600/5	2.015	NA	Director/D	
B.3498	Central	KHANNA	11KV	DS DIVN. KHANNA	DS S/D JARG	D0212FL02	IKOLAH	AMR	OK	31.03.2023	AP 3Phase 3Wire				914171	1200-600/5	2.841	NA	Director/D	
B.3499	Central	KHANNA	11KV	DS DIVN. KHANNA	DS S/D JARG	D0212FL03	JIBRA	AMR	OK	31.03.2023	AP 3Phase 3Wire				125887	400-200/5-5	2.966	NA	Director/D	
B.3500	Central	KHANNA	11KV	DS DIVN. KHANNA	DS S/D JARG	D0212FL12	11KV RAM RAJAYA	AMR	OK	31.03.2023	Category 1				125478	400-200/5-5	5.013	NA	Director/D	
B.3501	Central	KHANNA	11KV	DS DIVN. KHANNA	DS S/D JARG	D0212FL04	GT ROAD	AMR	OK	31.03.2023	Category 1				125877	400-200/5-5	6.781	NA	Director/D	
B.3502	Central	KHANNA	11KV	DS DIVN. KHANNA	DS S/D JARG	D0212FL08	Bhattani	NON AMR	OK	31.03.2023	Category 1				125479	1200-600/5	6.977	NA	Director/D	
B.3503	Central	KHANNA	11KV	DS DIVN. KHANNA	DS S/D JARG	D0212FL06	Chai Agro	AMR	OK	31.03.2023	Category 2				9154434	1200-600/5	7.053	NA	Director/D	
B.3504	Central	KHANNA	11KV	DS DIVN. KHANNA	DS S/D JARG	D0212FL01	SAHNI KOTLA ROAD	AMR	OK	31.03.2023	Category 1				2068529	1200-600/5	9.889	NA	Director/D	
B.3505	Central	KHANNA	11KV	DS DIVN. KHANNA	DS S/D JARG	D0212FL06	SALANA	AMR	OK	31.03.2023	AP 3Phase 3Wire				9141097	1200-600/5	1.927	NA	Director/D	
B.3506	Central	KHANNA	11KV	DS DIVN. SIRHIND	DS CITY S/D BASSI PATHANAN	D0202FL07	LALANA	AMR	OK	31.03.2023	AP 3Phase 3Wire				2066774	900-450/5	1.753	NA	Director/D	
B.3507	Central	KHANNA	11KV	DS DIVN. SIRHIND	DS CITY S/D BASSI PATHANAN	D0202FL03	MAHADIAN	AMR	OK	31.03.2023	AP 3Phase 3Wire				8268128	900-450/5	2.621	NA	Director/D	
B.3508	Central	KHANNA	11KV	DS DIVN. SIRHIND	DS CITY S/D BASSI PATHANAN	D0202FL18	Ferozpur	NON AMR	OK	31.03.2023	AP 3Phase 3Wire				2062309	900-450/5	3.809	NA	Director/D	
B.3509	Central	KHANNA	11KV	DS DIVN. SIRHIND	DS CITY S/D BASSI PATHANAN	D0202FL13	Khat Swarop Sahib	AMR	OK	31.03.2023	Category 1				1234456	1200-600/5	4.563	NA	Director/D	
B.3510	Central	KHANNA	11KV	DS DIVN. SIRHIND	DS CITY S/D BASSI PATHANAN	D0202FL23	Mata Rani	AMR	OK	31.03.2023	Category 1				125478	1200-600/5	6.686	NA	Director/D	
B.3511	Central	KHANNA	11KV	DS DIVN. SIRHIND	DS CITY S/D BASSI PATHANAN	D0202FL17	baghshkander	AMR	OK	31.03.2023	Category 5-U/PS				2067634	1200-600/5	4.837	NA	Director/D	
B.3512	Central	KHANNA	11KV	DS DIVN. SIRHIND	DS CITY S/D BASSI PATHANAN	D0202FL19	Rosa Shareef	AMR	OK	31.03.2023	Category 1				124587	1200-600/5	4.921	NA	Director/D	
B.3513	Central	KHANNA	11KV	DS DIVN. SIRHIND	DS CITY S/D BASSI PATHANAN	D0202FL22	Nanak Darbar	AMR	OK	31.03.2023	Category 1				125487	900-450/5	6.652	NA	Director/D	
B.3514	Central	KHANNA	11KV	DS DIVN. SIRHIND	DS CITY S/D BASSI PATHANAN	D0202FL04	CITY BASSI	AMR	OK	31.03.2023	Category 1				124578	900-450/5	8.168	NA	Director/D	
B.3515	Central	KHANNA	11KV	DS DIVN. SIRHIND	DS CITY S/D BASSI PATHANAN	D0212FL03	ATTAVALI	AMR	OK	31.03.2023	AP 3Phase 3Wire				2099417	900-450/5	2.594	NA	Director/D	
B.3516	Central	KHANNA	11KV	DS DIVN. SIRHIND	DS CITY S/D BASSI PATHANAN	D0212FL11	gilly	NON AMR	OK	31.03.2023	Category 5-U/PS				2067032	900-450/5	3.293	NA	Director/D	
B.3517	Central	KHANNA	11KV	DS DIVN. SIRHIND	DS CITY S/D BASSI PATHANAN	D0212FL12	JODHPUR	AMR	OK	31.03.2023	Category 5-U/PS				1234456	900-450/5	5.662	NA	Director/D	
B.3518	Central	KHANNA	11KV	DS DIVN. SIRHIND	DS CITY S/D BASSI PATHANAN	D0212FL01	HOSPITAL	AMR	OK	31.03.2023	Category 4				124569	900-450/5	2.602	NA	Director/D	
B.3519	Central	KHANNA	11KV	DS DIVN. SIRHIND	DS CITY S/D BASSI PATHANAN	D0212FL08	AAM KHASS BAGH	AMR	OK	31.03.2023	Category 1				9154172	900-450/5	5.728	NA	Director/D	
B.3520	Central	KHANNA	11KV	DS DIVN. SIRHIND	DS CITY S/D BASSI PATHANAN	D0212FL15	IKOLAH	AMR	OK	31.03.2023	Category 1				8223809	900-450/5	12.446	NA	Director/D	
B.3521	Central	KHANNA	11KV	DS DIVN. SIRHIND	DS CITY S/D BASSI PATHANAN	D0212FL02	FATEHGARH SAHIB	AMR	OK	31.03.2023	Category 1				1234456	900-450/5	14.181	NA	Director/D	
B.3522	Central	KHANNA	11KV	DS DIVN. SIRHIND	DS CITY S/D BASSI PATHANAN	D0212FL12	ANAI MANDI	AMR												

S.No	Zone	Circle	Voltage Level (kVA)	Division (kVA)	Sub-Division (kVA)	Feeder ID	Feeder Name	Feeder Metering Status (Metered/unmetered/AMR/AMI)	Status of Meter (Functional/Non-Functional)	Metering Date (Date of last actual meter reading/communication)	Feeder Type (Agr/Industrial/Mixed)	Status of Communication			Period from 01.04.2021 to 31.03.2022				Sales	Remarks (Source of data)
												% data received through automatically if feeder AMR/AMI	Number of hours when meter was unable to communicate in overall	Total Number of hours in the period	Meter S.No	CT/PT ratio	Import (kWh)	Export (kWh)		
B.3559	Central	KHANNA	11kV	DS DIVN. SIRHIND	DS S/D CHAURWALA	D108FL30	Majra	AMR	OK	31.03.2023	AP 3Phase 3Wire				125478	1200-600/5	0.328	NA	Director/D	
B.3560	Central	KHANNA	11kV	DS DIVN. SIRHIND	DS S/D CHAURWALA	D108FL29	Tiwana Unit 2	AMR	OK	31.03.2023	Category 4				124587	1200-600/5	0.344	NA	Director/D	
B.3561	Central	KHANNA	11kV	DS DIVN. SIRHIND	DS S/D CHAURWALA	D108FL28	Shreeji	AMR	OK	31.03.2023	Category 4				206522	900-450/5	0.778	NA	Director/D	
B.3562	Central	KHANNA	11kV	DS DIVN. SIRHIND	DS S/D CHAURWALA	D108FL26	Khawa Special	AMR	OK	31.03.2023	AP 3Phase 3Wire				124587	900-450/5	1.443	NA	Director/D	
B.3563	Central	KHANNA	11kV	DS DIVN. SIRHIND	DS S/D CHAURWALA	D108FL08	KHERORA	AMR	OK	31.03.2023	AP 3Phase 3Wire				422108	1200-600/5	1.839	NA	Director/D	
B.3564	Central	KHANNA	11kV	DS DIVN. SIRHIND	DS S/D CHAURWALA	D108FL16	JHINJERA BRANCH	AMR	OK	31.03.2023	AP 3Phase 3Wire				2066739	900-450/5	2.090	NA	Director/D	
B.3565	Central	KHANNA	11kV	DS DIVN. SIRHIND	DS S/D CHAURWALA	D108FL15	ADAMPUR	AMR	OK	31.03.2023	AP 3Phase 3Wire				123687	1200-600/5	2.273	NA	Director/D	
B.3566	Central	KHANNA	11kV	DS DIVN. SIRHIND	DS S/D CHAURWALA	D108FL06	ROHARGARH	AMR	OK	31.03.2023	AP 3Phase 3Wire				8223845	900-450/5	2.288	NA	Director/D	
B.3567	Central	KHANNA	11kV	DS DIVN. SIRHIND	DS S/D CHAURWALA	D108FL20	Reona	AMR	OK	31.03.2023	AP 3Phase 3Wire				124879	1200-600/5	2.306	NA	Director/D	
B.3568	Central	KHANNA	11kV	DS DIVN. SIRHIND	DS S/D CHAURWALA	D108FL02	CHENARTHAL	AMR	OK	31.03.2023	AP 3Phase 3Wire				2073639	900-450/5	2.321	NA	Director/D	
B.3569	Central	KHANNA	11kV	DS DIVN. SIRHIND	DS S/D CHAURWALA	D108FL19	Saifapur	AMR	OK	31.03.2023	AP 3Phase 3Wire				8222920	900-450/5	2.496	NA	Director/D	
B.3570	Central	KHANNA	11kV	DS DIVN. SIRHIND	DS S/D CHAURWALA	D108FL07	LATOUR	AMR	OK	31.03.2023	AP 3Phase 3Wire				2067927	1200-600/5	2.579	NA	Director/D	
B.3571	Central	KHANNA	11kV	DS DIVN. SIRHIND	DS S/D CHAURWALA	D108FL03	MULEPUR	AMR	OK	31.03.2023	AP 3Phase 3Wire				2066522	1200-600/5	2.638	NA	Director/D	
B.3572	Central	KHANNA	11kV	DS DIVN. SIRHIND	DS S/D CHAURWALA	D108FL21	Naamhari	AMR	OK	31.03.2023	AP 3Phase 3Wire				125478	900-450/5	2.868	NA	Director/D	
B.3573	Central	KHANNA	11kV	DS DIVN. SIRHIND	DS S/D CHAURWALA	D108FL12	RAUNGER NAGAR	AMR	OK	31.03.2023	AP 3Phase 3Wire				123658	900-450/5	3.133	NA	Director/D	
B.3574	Central	KHANNA	11kV	DS DIVN. SIRHIND	DS S/D CHAURWALA	D108FL09	PANDERAL	AMR	OK	31.03.2023	AP 3Phase 3Wire				2067639	1200-600/5	3.710	NA	Director/D	
B.3575	Central	KHANNA	11kV	DS DIVN. SIRHIND	DS S/D CHAURWALA	D108FL18	BALLPUR	AMR	OK	31.03.2023	Category 5-UPS				9534565	1200-600/5	4.401	NA	Director/D	
B.3576	Central	KHANNA	11kV	DS DIVN. SIRHIND	DS S/D CHAURWALA	D108FL10	PANJOLA	AMR	OK	31.03.2023	AP 3Phase 3Wire				2066970	900-450/5	4.603	NA	Director/D	
B.3577	Central	KHANNA	11kV	DS DIVN. SIRHIND	DS S/D CHAURWALA	D108FL01	JALKHERI	AMR	OK	31.03.2023	Category 1				2067700	900-450/5	6.193	NA	Director/D	
B.3578	Central	KHANNA	11kV	DS DIVN. SIRHIND	DS S/D CHAURWALA	D108FL17	KHARORI	AMR	OK	31.03.2023	Category 5-UPS				7421478	1200-600/5	8.796	NA	Director/D	
B.3579	Central	KHANNA	11kV	DS DIVN. SIRHIND	DS S/D CHAURWALA	D108FL14	WANA OIL	AMR	OK	31.03.2023	Category 2				125478	900-450/5	9.032	NA	Director/D	
B.3580	Central	KHANNA	11kV	DS DIVN. SIRHIND	DS S/D CHAURWALA	D108FL11	NARAINGARH CHANNA	Not available	OK	31.03.2023	Category 5-UPS				9154015	1200-600/5	10.374	NA	Director/D	
B.3581	Central	KHANNA	11kV	DS DIVN. SIRHIND	DS S/D CHAURWALA	D108FL25	Shri jee	Not available	OK	31.03.2023	Category 2				Not available	Not available	0.571	NA	Director/D	
B.3582	Central	KHANNA	66kV	DS DIVN. SIRHIND	DS S/D CHAURWALA	D108FL27	Vayu products	AMR	OK	31.03.2023	Category 2				Not available	Not available	28.903	NA	Director/D	
B.3583	Central	KHANNA	11kV	DS DIVN. SIRHIND	DS S/U S/D BASSI PATHANAN	D120FL20	Bhushi	AMR	OK	31.03.2023	AP 3Phase 3Wire				2068030	1200-600/5	0.000	NA	Director/D	
B.3584	Central	KHANNA	11kV	DS DIVN. SIRHIND	DS S/U S/D BASSI PATHANAN	D120FL01	KERON	NON AMR	OK	31.03.2023	AP 3Phase 3Wire				123456	900-450/5	0.000	NA	Director/D	
B.3585	Central	KHANNA	11kV	DS DIVN. SIRHIND	DS S/U S/D BASSI PATHANAN	D120FL02	RAMGARH [MULLANPUR OLD]	AMR	OK	31.03.2023	AP 3Phase 3Wire				123456	1200-600/5	1.630	NA	Director/D	
B.3586	Central	KHANNA	11kV	DS DIVN. SIRHIND	DS S/U S/D BASSI PATHANAN	D120FL06	KERON	AMR	OK	31.03.2023	AP 3Phase 3Wire				2068030	1200-600/5	1.741	NA	Director/D	
B.3587	Central	KHANNA	11kV	DS DIVN. SIRHIND	DS S/U S/D BASSI PATHANAN	D120FL15	KALERA	AMR	OK	31.03.2023	AP 3Phase 3Wire				126548	1200-600/5	2.096	NA	Director/D	
B.3588	Central	KHANNA	11kV	DS DIVN. SIRHIND	DS S/U S/D BASSI PATHANAN	D120FL08	KALOUR - Bhangua	AMR	OK	31.03.2023	AP 3Phase 3Wire				2067008	900-450/5	2.463	NA	Director/D	
B.3589	Central	KHANNA	11kV	DS DIVN. SIRHIND	DS S/U S/D BASSI PATHANAN	D120FL16	NDGAWAN	AMR	OK	31.03.2023	AP 3Phase 3Wire				2068435	1200-600/5	2.847	NA	Director/D	
B.3590	Central	KHANNA	11kV	DS DIVN. SIRHIND	DS S/U S/D BASSI PATHANAN	D120FL05	KARIMPURA	AMR	OK	31.03.2023	AP 3Phase 3Wire				2067200	1200-600/5	3.001	NA	Director/D	
B.3591	Central	KHANNA	11kV	DS DIVN. SIRHIND	DS S/U S/D BASSI PATHANAN	D120FL01	NANDPUR	AMR	OK	31.03.2023	AP 3Phase 3Wire				5295694	900-450/5	7.105	NA	Director/D	
B.3592	Central	KHANNA	11kV	DS DIVN. SIRHIND	DS S/U S/D BASSI PATHANAN	D120FL10	KHERI BHAJI KI	AMR	OK	31.03.2023	Category 5-UPS				2068363	1200-600/5	7.604	NA	Director/D	
B.3593	Central	KHANNA	11kV	DS DIVN. SIRHIND	DS S/U S/D BASSI PATHANAN	D120FL11	KISHANPURA	AMR	OK	31.03.2023	Category 5-UPS				7035645	1200-600/5	9.218	NA	Director/D	
B.3594	Central	KHANNA	11kV	DS DIVN. SIRHIND	DS S/U S/D BASSI PATHANAN	D114FL04	BHERONPUR	AMR	OK	31.03.2023	AP 3Phase 3Wire				9154228	900-450/5	3.183	NA	Director/D	
B.3595	Central	KHANNA	11kV	DS DIVN. SIRHIND	DS S/U S/D BASSI PATHANAN	D121FL02	SOPLAN	NON AMR	OK	31.03.2023	Category 3				204576	900-450/5	3.926	NA	Director/D	
B.3596	Central	KHANNA	11kV	DS DIVN. SIRHIND	DS S/U S/D BASSI PATHANAN	D121FL08	Dadiga oil main majr	AMR	OK	31.03.2023	AP 3Phase 3Wire				123456	900-450/5	2.188	NA	Director/D	
B.3597	Central	KHANNA	11kV	DS DIVN. SIRHIND	DS S/U S/D BASSI PATHANAN	D121FL09	MARWA	AMR	OK	31.03.2023	AP 3Phase 3Wire				214568	900-450/5	2.252	NA	Director/D	
B.3598	Central	KHANNA	11kV	DS DIVN. SIRHIND	DS S/U S/D BASSI PATHANAN	D121FL03	MAIN MAIRI	AMR	OK	31.03.2023	AP 3Phase 3Wire				204508	900-450/5	2.735	NA	Director/D	
B.3599	Central	KHANNA	11kV	DS DIVN. SIRHIND	DS S/U S/D BASSI PATHANAN	D121FL04	KAMALI	AMR	OK	31.03.2023	AP 3Phase 3Wire				204506	900-450/5/771-1-1	2.749	NA	Director/D	
B.3600	Central	KHANNA	11kV	DS DIVN. SIRHIND	DS S/U S/D BASSI PATHANAN	D121FL10	Koti	AMR	OK	31.03.2023	Category 5-UPS				207922	900-450/5	2.927	NA	Director/D	
B.3601	Central	KHANNA	11kV	DS DIVN. SIRHIND	DS S/U S/D BASSI PATHANAN	D121FL07	RESIN	AMR	OK	31.03.2023	AP 3Phase 3Wire				125478	900-450/5771-1-1	3.066	NA	Director/D	
B.3602	Central	KHANNA	11kV	DS DIVN. SIRHIND	DS S/U S/D BASSI PATHANAN	D121FL01	MULLANPUR NEW	AMR	OK	31.03.2023	AP 3Phase 3Wire				1209452	900-450/5771-1-1	3.288	NA	Director/D	
B.3603	Central	KHANNA	11kV	DS DIVN. SIRHIND	DS S/U S/D BASSI PATHANAN	D121FL06	24 Hrs. KALUAR	NON AMR	OK	31.03.2023	Category 5-UPS				123456	900-450/5771-1-1	3.965	NA	Director/D	
B.3604	Central	KHANNA	11kV	DS DIVN. SIRHIND	DS S/U S/D SIRHIND	8101FL17	KAHNA	NON AMR	OK	31.03.2023	Category 3				30267	1200-600/5	0.000	NA	Director/D	
B.3605	Central	KHANNA	11kV	DS DIVN. SIRHIND	DS S/U S/D SIRHIND	8101FL11	FATEHWAR	AMR	OK	31.03.2023	AP 3Phase 3Wire				1114558	1200-600/5	1.728	NA	Director/D	
B.3606	Central	KHANNA	11kV	DS DIVN. SIRHIND	DS S/U S/D SIRHIND	8101FL15	SATRAL STRIPS	AMR	OK	31.03.2023	Category 3				204508	1200-600/5	2.466	NA	Director/D	
B.3607	Central	KHANNA	11kV	DS DIVN. SIRHIND	DS S/U S/D SIRHIND	8101FL12	NATURAL	AMR	OK	31.03.2023	Category 2				124587	400-200/5-5	3.783	NA	Director/D	
B.3608	Central	KHANNA	11kV	DS DIVN. SIRHIND	DS S/U S/D SIRHIND	8101FL21	BHIKSHU	AMR	OK	31.03.2023	Category 3				124587	400-200/5-5	12.541	NA	Director/D	
B.3609	Central	KHANNA	11kV	DS DIVN. SIRHIND	DS S/U S/D SIRHIND	8129E12	JMK Feeder	AMR	OK	31.03.2023	Category 2				125478	1200-600/5	13.431	NA	Director/D	
B.3610	Central	KHANNA	11kV	DS DIVN. SIRHIND	DS S/U S/D SIRHIND	8129E011	MATA	AMR	OK	31.03.2023	Category 3				124578	400-200/5-5	17.395	NA	Director/D	
B.3611	Central	KHANNA	11kV	DS DIVN. SIRHIND	DS S/U S/D SIRHIND	8129E19	Tea Deo Alloys	AMR	OK	31.03.2023	Category 3				125478	1200-600/5	20.122	NA	Director/D	
B.3612	Central	KHANNA	11kV	DS DIVN. SIRHIND	DS S/U S/D SIRHIND	8101FL13	JATIN	AMR	OK	31.03.2023	Category 3				124578	400-200/5-5	25.489	NA	Director/D	
B.3613	Central	KHANNA	11kV	DS DIVN. SIRHIND	DS S/U S/D SIRHIND	8101FL23	Salsar	NON AMR	OK	31.03.2023	Category 3				123456	400-200/5-5	29.873	NA	Director/D	
B.3614	Central	KHANNA	11kV	DS DIVN. SIRHIND	DS S/U S/D SIRHIND	8101FL22	KHERI	AMR	OK	31.03.2023	AP 3Phase 3Wire				8222406	1200-600/5	1.391	NA	Director/D	
B.3615	Central	KHANNA	11kV	DS DIVN. SIRHIND	DS S/U S/D SIRHIND	8101FL02	MULLANPUR	AMR	OK	31.03.2023	AP 3Phase 3Wire				8223765	1200-600/5	1.570	NA	Director/D	
B.3616	Central	KHANNA	11kV	DS DIVN. SIRHIND	DS S/U S/D SIRHIND	8101FL10	WAIKABAD	AMR	OK	31.03.2023	Category 5-UPS				2066992	1200-600/5	1.713	NA	Director/D	
B.3617	Central	KHANNA	11kV	DS DIVN. SIRHIND	DS S/U S/D SIRHIND	8101FL18	SOPAN	AMR	OK	31.03.2023	AP 3Phase 3Wire				123456	1200-600/5	1.936	NA	Director/D	
B.3618	Central	KHANNA	11kV	DS DIVN. SIRHIND	DS S/U S/D SIRHIND	8141FL19	RANDHAWA	NON AMR	OK	31.03.2023	AP 3Phase 3Wire				1028300	900-450/5	2.373	NA	Director/D	
B.3619	Central	KHANNA	11kV	DS DIVN. SIRHIND	DS S/U S/D SIRHIND	D114FL31	DERA MIR MIRAN	AMR	OK	31.03.2023	AP 3Phase 3Wire				123456	900-450/5	2.540	NA	Director/D	
B.3620	Central	KHANNA	11kV	DS DIVN. SIRHIND	DS S/U S/D SIRHIND	D114FL05	MANDOFAL	AMR	OK	31.03.2023	AP 3Phase 3Wire				2068782	900-450/5	2.706	NA	Director/D	
B.3621	Central	KHANNA	11kV	DS DIVN. SIRHIND	DS S/U S/D SIRHIND	D114FL09	BORAN	AMR	OK	31.03.2023	AP 3Phase 3Wire				10282876	900-450/5	2.898	NA	Director/D	
B.3622	Central	KHANNA	11kV	DS DIVN. SIRHIND	DS S/U S/D SIRHIND	D114FL07	HANSALI	AMR	OK	31.03.2023	Category 5-UPS				2067093	900-450/5	8.581	NA	Director/D	
B.3623	Central	KHANNA	11kV	DS DIVN. SIRHIND	DS S/U S/D SIRHIND	T133FL06	MIRAPUR	AMR	OK	31.03.2023	AP 3Phase 3Wire				123456	400-200/5-5	1.362	NA	Director/D	
B.3624	Central	KHANNA	11kV	DS DIVN. SIRHIND	DS S/U S/D SIRHIND	T133FL01	Sunderpura	AMR	OK	31.03.2023	AP 3Phase 3Wire									

S.No	Zone	Circle	Voltage Level (kVA)	Division (kVA)	Sub-Division (kVA)	Feeder ID	Feeder Name	Feeder Metering Status (Metered/unmetered/AMR/AMI)	Status of Meter (Functional/Non-Functional)	Metering Date	Date of last actual meter reading/communication	Feeder Type (Agr/Industrial/Mixed)	Status of Communication			Period from 01.04.2021 to 31.03.2022			Sales	Remarks (Source of data)
													% data received through automatically if feeder AMR/AMI	Number of hours when meter was unable to communicate in overall	Total Number of hours in the period	Meter S.No	CT/PT ratio	Import (kWh)		
B.3656	Central	SUB URBAN LUDHIANA	11KV	DS DIVN. ADDA DAKHA	DS CITY S/D ADDA DAKHA	0054FL23	Urban Mashkiana Sahib	AMR	OK	31.03.2023		Category 1				3311	1200/577/1-1-1	3.367	NA	Director/D
B.3657	Central	SUB URBAN LUDHIANA	11KV	DS DIVN. ADDA DAKHA	DS CITY S/D ADDA DAKHA	0054FL15	Urban Havelli	AMR	OK	31.03.2023		Category 5-UPS				9153626	1200/577/1-1-1	6.422	NA	Director/D
B.3658	Central	SUB URBAN LUDHIANA	11KV	DS DIVN. ADDA DAKHA	DS CITY S/D ADDA DAKHA	0054FL18	Rurka City	AMR	OK	31.03.2023		Category 5-UPS				16194308	1200/577/1-1-1	6.737	NA	Director/D
B.3659	Central	SUB URBAN LUDHIANA	11KV	DS DIVN. ADDA DAKHA	DS CITY S/D ADDA DAKHA	0054FL11	Bhawal City	AMR	OK	31.03.2023		Category 5-UPS				9564680	1200/600/5	9.708	NA	Director/D
B.3660	Central	SUB URBAN LUDHIANA	11KV	DS DIVN. ADDA DAKHA	DS CITY S/D ADDA DAKHA	0054FL16	Urban AljtSar	AMR	OK	31.03.2023		Category 1				8223636	1200/577/1-1-1	9.723	NA	Director/D
B.3661	Central	SUB URBAN LUDHIANA	11KV	DS DIVN. ADDA DAKHA	DS CITY S/D ADDA DAKHA	0054FL02	Urban Adda Dakha	AMR	OK	31.03.2023		Category 1				36770	1200/577/1-1-1	11.772	NA	Director/D
B.3662	Central	SUB URBAN LUDHIANA	11KV	DS DIVN. ADDA DAKHA	DS CITY S/D ADDA DAKHA	0055FL15	Khandor	AMR	OK	31.03.2023		AP 3Phase 3Wire				9154224	1200/600/5	1.931	NA	Director/D
B.3663	Central	SUB URBAN LUDHIANA	11KV	DS DIVN. ADDA DAKHA	DS CITY S/D ADDA DAKHA	0055FL23	Rurka (R)	NON AMR	OK	31.03.2023		AP 3Phase 3Wire				3143	900/450/577/1-1-1	2.303	NA	Director/D
B.3664	Central	SUB URBAN LUDHIANA	11KV	DS DIVN. ADDA DAKHA	DS CITY S/D ADDA DAKHA	0055FL21	New Khandor	AMR	OK	31.03.2023		AP 3Phase 3Wire				23406	900/450/577/1-1-1	2.784	NA	Director/D
B.3665	Central	SUB URBAN LUDHIANA	11KV	DS DIVN. ADDA DAKHA	DS CITY S/D ADDA DAKHA	0055FL12	Hissawal	AMR	OK	31.03.2023		AP 3Phase 3Wire				8223173	1200/600/5	2.784	NA	Director/D
B.3666	Central	SUB URBAN LUDHIANA	11KV	DS DIVN. ADDA DAKHA	DS S/D HUMBRAN	0051FL20	Bassian Bet (R)	NON AMR	OK	31.03.2023		AP 3Phase 3Wire				15193795	900/450/5	1.413	NA	Director/D
B.3667	Central	SUB URBAN LUDHIANA	11KV	DS DIVN. ADDA DAKHA	DS S/D HUMBRAN	0051FL07	Bharowal	AMR	OK	31.03.2023		AP 3Phase 3Wire				109	1200/577/1-1-1	1.912	NA	Director/D
B.3668	Central	SUB URBAN LUDHIANA	11KV	DS DIVN. ADDA DAKHA	DS S/D HUMBRAN	0051FL19	Bassian bet (U)	NON AMR	OK	31.03.2023		Category 5-UPS				11052056	900/450/5	2.090	NA	Director/D
B.3669	Central	SUB URBAN LUDHIANA	11KV	DS DIVN. ADDA DAKHA	DS S/D HUMBRAN	0051FL15	Bhundi	NON AMR	OK	31.03.2023		AP 3Phase 3Wire				101	1200/577/1-1-1	2.630	NA	Director/D
B.3670	Central	SUB URBAN LUDHIANA	11KV	DS DIVN. ADDA DAKHA	DS S/D HUMBRAN	0051FL17	Majeri	AMR	OK	31.03.2023		AP 3Phase 3Wire				32	900/450/5	4.795	NA	Director/D
B.3671	Central	SUB URBAN LUDHIANA	11KV	DS DIVN. ADDA DAKHA	DS S/D HUMBRAN	8052FL08	Bagga Kalan	AMR	OK	31.03.2023		AP 3Phase 3Wire				2066913	1200/600/5	1.288	NA	Director/D
B.3672	Central	SUB URBAN LUDHIANA	11KV	DS DIVN. ADDA DAKHA	DS S/D HUMBRAN	8052FL11	COSMOS	AMR	OK	31.03.2023		Category 1				30300	1200/600/5	2.015	NA	Director/D
B.3673	Central	SUB URBAN LUDHIANA	11KV	DS DIVN. ADDA DAKHA	DS S/D HUMBRAN	8052FL10	Nurpur Bet	AMR	OK	31.03.2023		AP 3Phase 3Wire				2066643	1200/600/5	2.162	NA	Director/D
B.3674	Central	SUB URBAN LUDHIANA	11KV	DS DIVN. ADDA DAKHA	DS S/D HUMBRAN	8052FL01	Purain	NON AMR	OK	31.03.2023		AP 3Phase 3Wire				2066677	1200/600/5	2.579	NA	Director/D
B.3675	Central	SUB URBAN LUDHIANA	11KV	DS DIVN. ADDA DAKHA	DS S/D HUMBRAN	8052FL19	Gill AP	AMR	OK	31.03.2023		AP 3Phase 3Wire				6761909	1200/600/5	2.598	NA	Director/D
B.3676	Central	SUB URBAN LUDHIANA	11KV	DS DIVN. ADDA DAKHA	DS S/D HUMBRAN	8052FL07	Alnah	NON AMR	OK	31.03.2023		Category 5-UPS				10252843	1200/600/5	2.793	NA	Director/D
B.3677	Central	SUB URBAN LUDHIANA	11KV	DS DIVN. ADDA DAKHA	DS S/D HUMBRAN	8052D005	DEWINE INDUSTRY	AMR	OK	31.03.2023		Category 4				15194868	1200/600/5	2.840	NA	Director/D
B.3678	Central	SUB URBAN LUDHIANA	11KV	DS DIVN. ADDA DAKHA	DS S/D HUMBRAN	8052FL15	CHAK AP	AMR	OK	31.03.2023		AP 3Phase 3Wire				11117204	1200/600/5	2.890	NA	Director/D
B.3679	Central	SUB URBAN LUDHIANA	11KV	DS DIVN. ADDA DAKHA	DS S/D HUMBRAN	8052FL02	Salampur	AMR	OK	31.03.2023		AP 3Phase 3Wire				2067635	1200/600/5	3.382	NA	Director/D
B.3680	Central	SUB URBAN LUDHIANA	11KV	DS DIVN. ADDA DAKHA	DS S/D HUMBRAN	8052FL04	Bhattian	AMR	OK	31.03.2023		AP 3Phase 3Wire				8223692	1200/600/5	3.639	NA	Director/D
B.3681	Central	SUB URBAN LUDHIANA	11KV	DS DIVN. ADDA DAKHA	DS S/D HUMBRAN	8052FL06	Basani	AMR	OK	31.03.2023		Category 5-UPS				15099	1200/600/5	4.614	NA	Director/D
B.3682	Central	SUB URBAN LUDHIANA	11KV	DS DIVN. ADDA DAKHA	DS S/D HUMBRAN	8052FL18	WALPUR (U)	AMR	OK	31.03.2023		Category 5-UPS				8223693	1200/600/5	5.654	NA	Director/D
B.3683	Central	SUB URBAN LUDHIANA	11KV	DS DIVN. ADDA DAKHA	DS S/D HUMBRAN	8052FL09	Paper Mill	AMR	OK	31.03.2023		Category 2				2066368	1200/600/5	5.739	NA	Director/D
B.3684	Central	SUB URBAN LUDHIANA	11KV	DS DIVN. ADDA DAKHA	DS S/D HUMBRAN	8052FL21	BTL	AMR	OK	31.03.2023		Category 2				8736	1200/600/5	6.845	NA	Director/D
B.3685	Central	SUB URBAN LUDHIANA	11KV	DS DIVN. ADDA DAKHA	DS S/D HUMBRAN	0052FL16	CHAK (U)	AMR	OK	31.03.2023		Category 5-UPS				5295546	1200/600/5	7.058	NA	Director/D
B.3686	Central	SUB URBAN LUDHIANA	11KV	DS DIVN. ADDA DAKHA	DS S/D HUMBRAN	0052FL22	11 Ivy plywood	AMR	OK	31.03.2023		Category 2				5409	1200/800/5	8.125	NA	Director/D
B.3687	Central	SUB URBAN LUDHIANA	11KV	DS DIVN. ADDA DAKHA	DS S/D HUMBRAN	8052FL14	Messina Metro Cast	AMR	OK	31.03.2023		Category 4				9352621	1200/600/5	10.866	NA	Director/D
B.3688	Central	SUB URBAN LUDHIANA	11KV	DS DIVN. ADDA DAKHA	DS S/D HUMBRAN	8052FL20	Gospur	AMR	OK	31.03.2023		Category 1				45692	1200/600/5	10.992	NA	Director/D
B.3689	Central	SUB URBAN LUDHIANA	11KV	DS DIVN. ADDA DAKHA	DS S/D HUMBRAN	8052FL05	Industrial	AMR	OK	31.03.2023		Category 2				2067515	1200/600/5	11.628	NA	Director/D
B.3690	Central	SUB URBAN LUDHIANA	11KV	DS DIVN. ADDA DAKHA	DS S/D HUMBRAN	8052FL17	AMBICA	AMR	OK	31.03.2023		Category 4				10282944	1200/600/5	19.959	NA	Director/D
B.3691	Central	SUB URBAN LUDHIANA	11KV	DS DIVN. ADDA DAKHA	DS S/D HUMBRAN	0071FL08	Gorahour (R)	AMR	OK	31.03.2023		AP 3Phase 3Wire				5437518	1200/577/1-1-1	0.838	NA	Director/D
B.3692	Central	SUB URBAN LUDHIANA	11KV	DS DIVN. ADDA DAKHA	DS S/D HUMBRAN	0071FL10	11 walpur Khard AP	AMR	OK	31.03.2023		AP 3Phase 3Wire				5274	1200/577/1-1-1	1.817	NA	Director/D
B.3693	Central	SUB URBAN LUDHIANA	11KV	DS DIVN. ADDA DAKHA	DS S/D HUMBRAN	0071FL06	Rangpur	NON AMR	OK	31.03.2023		AP 3Phase 3Wire				4262746	1200/577/1-1-1	2.246	NA	Director/D
B.3694	Central	SUB URBAN LUDHIANA	11KV	DS DIVN. ADDA DAKHA	DS S/D HUMBRAN	0071FL05	Bhundi	AMR	OK	31.03.2023		Category 5-UPS				36770	1200/577/1-1-1	2.781	NA	Director/D
B.3695	Central	SUB URBAN LUDHIANA	11KV	DS DIVN. ADDA DAKHA	DS S/D HUMBRAN	0073FL04	MEGA FOOD PARK NO 4	AMR	OK	31.03.2023		Category 2				2640	1200/577/1-1-1	0.321	NA	Director/D
B.3696	Central	SUB URBAN LUDHIANA	11KV	DS DIVN. ADDA DAKHA	DS S/D HUMBRAN	0073FL02	MEGA FOOD PARK NO-02	AMR	OK	31.03.2023		Category 2				2956	1200/577/1-1-1	0.589	NA	Director/D
B.3697	Central	SUB URBAN LUDHIANA	11KV	DS DIVN. ADDA DAKHA	DS S/D HUMBRAN	0073FL01	GOBRIE TILSON	AMR	OK	31.03.2023		Category 2				2844	1200/577/1-1-1	1.240	NA	Director/D
B.3698	Central	SUB URBAN LUDHIANA	11KV	DS DIVN. ADDA DAKHA	DS S/D HUMBRAN	0073FL07	HERA	AMR	OK	31.03.2023		AP 3Phase 3Wire				2819	1200/577/1-1-1	4.420	NA	Director/D
B.3699	Central	SUB URBAN LUDHIANA	11KV	DS DIVN. ADDA DAKHA	DS S/D HUMBRAN	0073FL08	RASOOLPUR	AMR	OK	31.03.2023		AP 3Phase 3Wire				3343	1200/577/1-1-1	1.798	NA	Director/D
B.3700	Central	SUB URBAN LUDHIANA	11KV	DS DIVN. ADDA DAKHA	DS S/D HUMBRAN	0073FL03	ESKON BALA II	AMR	OK	31.03.2023		Category 2				2841	1200/577/1-1-1	2.058	NA	Director/D
B.3701	Central	SUB URBAN LUDHIANA	11KV	DS DIVN. ADDA DAKHA	DS S/D HUMBRAN	0073FL15	Seed Farm	AMR	OK	31.03.2023		Category 1				2797	1200/577/1-1-1	3.819	NA	Director/D
B.3702	Central	SUB URBAN LUDHIANA	11KV	DS DIVN. ADDA DAKHA	DS S/D HUMBRAN	0073FL06	RIAPUR UPS	AMR	OK	31.03.2023		Category 5-UPS				3471	1200/577/1-1-1	7.904	NA	Director/D
B.3703	Central	SUB URBAN LUDHIANA	11KV	DS DIVN. ADDA DAKHA	DS S/D HUMBRAN	8054FL01	M/S PAKKHOWA	AMR	OK	31.03.2023		Category 1				703021	1200/600/5	0.526	NA	Director/D
B.3704	Central	SUB URBAN LUDHIANA	11KV	DS DIVN. ADDA DAKHA	DS S/D SUDHAR	8054FL23	Saiba	AMR	OK	31.03.2023		AP 3Phase 3Wire				3082	1200/600/5	2.473	NA	Director/D
B.3705	Central	SUB URBAN LUDHIANA	11KV	DS DIVN. ADDA DAKHA	DS S/D SUDHAR	8054FL22	Toosey	AMR	OK	31.03.2023		AP 3Phase 3Wire				3030	1200/600/5	2.563	NA	Director/D
B.3706	Central	SUB URBAN LUDHIANA	11KV	DS DIVN. ADDA DAKHA	DS S/D SUDHAR	8054FL21	Halwara No 2	AMR	OK	31.03.2023		AP 3Phase 3Wire				266303	900/450/5	2.648	NA	Director/D
B.3707	Central	SUB URBAN LUDHIANA	11KV	DS DIVN. ADDA DAKHA	DS S/D SUDHAR	8054FL07	Halwara	AMR	OK	31.03.2023		AP 3Phase 3Wire				2066247	900/450/5	4.580	NA	Director/D
B.3708	Central	SUB URBAN LUDHIANA	11KV	DS DIVN. ADDA DAKHA	DS S/D SUDHAR	0067FL15	Sulapur (R)	AMR	OK	31.03.2023		AP 3Phase 3Wire				73194436	1200/600/5	1.687	NA	Director/D
B.3709	Central	SUB URBAN LUDHIANA	11KV	DS DIVN. ADDA DAKHA	DS S/D SUDHAR	0067FL08	HERA	AMR	OK	31.03.2023		Category 1				9154068	1200/600/5	3.440	NA	Director/D
B.3710	Central	SUB URBAN LUDHIANA	11KV	DS DIVN. ADDA DAKHA	DS S/D SUDHAR	0067FL10	BRAICH	AMR	OK	31.03.2023		AP 3Phase 3Wire				15051994	1200/600/5	2.507	NA	Director/D
B.3711	Central	SUB URBAN LUDHIANA	11KV	DS DIVN. ADDA DAKHA	DS S/D SUDHAR	0067FL02	Herran(R)	NON AMR												

S.No	Zone	Circle	Voltage Level (kVA)	Division (kVA)	Sub-Division (kVA)	Feeder ID	Feeder Name	Feeder Metering Status (Metered/unmetered/AMR/AMI)	Status of Meter (Functional/Non-Functional)	Metering Date (Date of last actual meter reading/communication)	Feeder Type (Agr/Industrial/Mixed)	Status of Communication			Period from 01.04.2021 to 31.03.2022				Sales	Remarks (Source of data)
												% data received through automatically by feeder AMR/AMI	Number of hours when meter was unable to communicate in overall	Total Number of hours in the period	Meter S.No	CT/PT ratio	Import (kWh)	Export (kWh)		
B.3753	Central	SUB URBAN LUDHIANA	11KV	DS DIVN. ADDA DAKHA	DS S/U S/D ADDA DAKHA	0067F08	Sekhpura	NON AMR	OK	31.03.2023	Category 5-UPS				36767	1200/577/1-1-1	3.990	NA	Director/D	
B.3754	Central	SUB URBAN LUDHIANA	11KV	DS DIVN. AHMEDGARH	DS CITY S/D AHD	0062F17	SUB STATION CITY AHMEDGARH	NON AMR	OK	31.03.2023	Category 1				3040119	Not installed	0.036	NA	Director/D	
B.3755	Central	SUB URBAN LUDHIANA	11KV	DS DIVN. AHMEDGARH	DS CITY S/D AHD	0062F18	Jagdish Chand	NON AMR	OK	31.03.2023	Category 4				1028863	Not installed	2.034	NA	Director/D	
B.3756	Central	SUB URBAN LUDHIANA	11KV	DS DIVN. AHMEDGARH	DS CITY S/D AHD	0062F15	Urban Ahmedgarh (City-3)	NON AMR	OK	31.03.2023	Category 1				1426389	Not installed	6.196	NA	Director/D	
B.3757	Central	SUB URBAN LUDHIANA	11KV	DS DIVN. AHMEDGARH	DS CITY S/D AHD	0062F14	Urban Main Bazar (City-4)	NON AMR	OK	31.03.2023	Category 1				1247960	900-450/5	6.483	NA	Director/D	
B.3758	Central	SUB URBAN LUDHIANA	11KV	DS DIVN. AHMEDGARH	DS CITY S/D AHD	0062F08	Urban Raikot Adda (City-1)	AMR	OK	31.03.2023	Category 1				4187999	Not installed	7.404	NA	Director/D	
B.3759	Central	SUB URBAN LUDHIANA	11KV	DS DIVN. AHMEDGARH	DS CITY S/D AHD	0062F33	Urban Gandhi School	AMR	OK	31.03.2023	Category 1				3543	Not installed	7.492	NA	Director/D	
B.3760	Central	SUB URBAN LUDHIANA	11KV	DS DIVN. AHMEDGARH	DS CITY S/D AHD	0062F31	Urban Anad Isher School	AMR	OK	31.03.2023	Category 1				3314	Not installed	9.158	NA	Director/D	
B.3761	Central	SUB URBAN LUDHIANA	11KV	DS DIVN. AHMEDGARH	DS CITY S/D AHD	0062F32	Urban Victoria College	NON AMR	OK	31.03.2023	Category 1				3536	900-450/5	9.898	NA	Director/D	
B.3762	Central	SUB URBAN LUDHIANA	11KV	DS DIVN. AHMEDGARH	DS CITY S/D AHD	0062F04	Urban New Gas Shale (City-2)	NON AMR	OK	31.03.2023	Category 1				2067531	Not installed	12.519	NA	Director/D	
B.3763	Central	SUB URBAN LUDHIANA	11KV	DS DIVN. AHMEDGARH	DS CITY S/D AHD	0062F09	SHRYANS PAPER MILL	AMR	OK	31.03.2023	Category 4				4187100	Not installed	16.430	NA	Director/D	
B.3764	Central	SUB URBAN LUDHIANA	11KV	DS DIVN. AHMEDGARH	DS S/D MALOUD	0063F13	JOGIPIR	NON AMR	OK	31.03.2023	AP 3Phase 3Wire				12479369	900-450/577/1-1-1	0.006	NA	Director/D	
B.3765	Central	SUB URBAN LUDHIANA	11KV	DS DIVN. AHMEDGARH	DS S/D MALOUD	0063F08	SUB STATION MALOUD	AMR	OK	31.03.2023	Category 1				3040221	900-450/577/1-1-1	0.031	NA	Director/D	
B.3766	Central	SUB URBAN LUDHIANA	11KV	DS DIVN. AHMEDGARH	DS S/D MALOUD	0063F11	Chommo	AMR	OK	31.03.2023	AP 3Phase 3Wire				8223051	900-450/577/1-1-1	0.040	NA	Director/D	
B.3767	Central	SUB URBAN LUDHIANA	11KV	DS DIVN. AHMEDGARH	DS S/D MALOUD	0063F01	Dudhli	AMR	OK	31.03.2023	AP 3Phase 3Wire				8223034	900-450/577/1-1-1	0.775	NA	Director/D	
B.3768	Central	SUB URBAN LUDHIANA	11KV	DS DIVN. AHMEDGARH	DS S/D MALOUD	0063F03	Naromara	AMR	OK	31.03.2023	AP 3Phase 3Wire				8222450	900-450/577/1-1-1	1.794	NA	Director/D	
B.3769	Central	SUB URBAN LUDHIANA	11KV	DS DIVN. AHMEDGARH	DS S/D MALOUD	0063F15	TIMBERWAL	AMR	OK	31.03.2023	AP 3Phase 3Wire				3962	900-450/577/1-1-1	2.264	NA	Director/D	
B.3770	Central	SUB URBAN LUDHIANA	11KV	DS DIVN. AHMEDGARH	DS S/D MALOUD	0063F14	SEKHA	AMR	OK	31.03.2023	AP 3Phase 3Wire				12479369	900-450/577/1-1-1	2.269	NA	Director/D	
B.3771	Central	SUB URBAN LUDHIANA	11KV	DS DIVN. AHMEDGARH	DS S/D MALOUD	0063F04	Sohian	AMR	OK	31.03.2023	AP 3Phase 3Wire				2066437	900-450/577/1-1-1	2.309	NA	Director/D	
B.3772	Central	SUB URBAN LUDHIANA	11KV	DS DIVN. AHMEDGARH	DS S/D MALOUD	0063F09	Rangarh	AMR	OK	31.03.2023	AP 3Phase 3Wire				8222449	900-450/577/1-1-1	2.605	NA	Director/D	
B.3773	Central	SUB URBAN LUDHIANA	11KV	DS DIVN. AHMEDGARH	DS S/D MALOUD	0063F17	JUKI	AMR	OK	31.03.2023	AP 3Phase 3Wire				12479610	900-450/577/1-1-1	2.754	NA	Director/D	
B.3774	Central	SUB URBAN LUDHIANA	11KV	DS DIVN. AHMEDGARH	DS S/D MALOUD	0063F02	Daud	AMR	OK	31.03.2023	AP 3Phase 3Wire				9141105	900-450/577/1-1-1	4.326	NA	Director/D	
B.3775	Central	SUB URBAN LUDHIANA	11KV	DS DIVN. AHMEDGARH	DS S/D MALOUD	0063F16	City-4	AMR	OK	31.03.2023	Category 1				7319075	900-450/577/1-1-1	4.372	NA	Director/D	
B.3776	Central	SUB URBAN LUDHIANA	11KV	DS DIVN. AHMEDGARH	DS S/D MALOUD	0063F10	Malo Daud	AMR	OK	31.03.2023	AP 3Phase 3Wire				8222446	900-450/577/1-1-1	4.456	NA	Director/D	
B.3777	Central	SUB URBAN LUDHIANA	11KV	DS DIVN. AHMEDGARH	DS S/D MALOUD	0063F06	Bekalan	NON AMR	OK	31.03.2023	AP 3Phase 3Wire				9141104	900-450/577/1-1-1	5.591	NA	Director/D	
B.3778	Central	SUB URBAN LUDHIANA	11KV	DS DIVN. AHMEDGARH	DS S/D MALOUD	0063F07	City-02	NON AMR	OK	31.03.2023	Category 5-UPS				2067293	900-450/577/1-1-1	6.162	NA	Director/D	
B.3779	Central	SUB URBAN LUDHIANA	11KV	DS DIVN. AHMEDGARH	DS S/D MALOUD	0063F05	City-1 Maloud	AMR	OK	31.03.2023	Category 1				2067294	900-450/577/1-1-1	7.040	NA	Director/D	
B.3780	Central	SUB URBAN LUDHIANA	11KV	DS DIVN. AHMEDGARH	DS S/D MALOUD	0063F12	City No-3 Maloud	AMR	OK	31.03.2023	Category 5-UPS				10282984	900-450/577/1-1-1	11.239	NA	Director/D	
B.3781	Central	SUB URBAN LUDHIANA	11KV	DS DIVN. AHMEDGARH	DS S/D MALOUD	0064F15	gosal	NON AMR	OK	31.03.2023	AP 3Phase 3Wire				12479371	1200/577/1-1-1	1.587	NA	Director/D	
B.3782	Central	SUB URBAN LUDHIANA	11KV	DS DIVN. AHMEDGARH	DS S/D SIHAR	0064F09	SUB STATION SIHAR	AMR	OK	31.03.2023	Category 1				917838	900-450/577/1-1-1	0.019	NA	Director/D	
B.3783	Central	SUB URBAN LUDHIANA	11KV	DS DIVN. AHMEDGARH	DS S/D SIHAR	0064F06	Zirri	AMR	OK	31.03.2023	AP 3Phase 3Wire				8222690	1200/577/1-1-1	1.131	NA	Director/D	
B.3784	Central	SUB URBAN LUDHIANA	11KV	DS DIVN. AHMEDGARH	DS S/D SIHAR	0064F17	KULAN HANS	AMR	OK	31.03.2023	AP 3Phase 3Wire				9338	1200/577/1-1-1	1.404	NA	Director/D	
B.3785	Central	SUB URBAN LUDHIANA	11KV	DS DIVN. AHMEDGARH	DS S/D SIHAR	0064F14	KHATTRA	AMR	OK	31.03.2023	AP 3Phase 3Wire				12479269	1200/577/1-1-1	1.534	NA	Director/D	
B.3786	Central	SUB URBAN LUDHIANA	11KV	DS DIVN. AHMEDGARH	DS S/D SIHAR	0064F13	ROSIANA	NON AMR	OK	31.03.2023	AP 3Phase 3Wire				12479851	1200/577/1-1-1	1.663	NA	Director/D	
B.3787	Central	SUB URBAN LUDHIANA	11KV	DS DIVN. AHMEDGARH	DS S/D SIHAR	0064F12	PANDHER KHERI	AMR	OK	31.03.2023	AP 3Phase 3Wire				2068210	1200/577/1-1-1	1.780	NA	Director/D	
B.3788	Central	SUB URBAN LUDHIANA	11KV	DS DIVN. AHMEDGARH	DS S/D SIHAR	0064F16	SARHAN MAURA UPS	AMR	OK	31.03.2023	Category 5-UPS				3328	1200/577/1-1-1	1.830	NA	Director/D	
B.3789	Central	SUB URBAN LUDHIANA	11KV	DS DIVN. AHMEDGARH	DS S/D SIHAR	0064F10	Shar	AMR	OK	31.03.2023	AP 3Phase 3Wire				8223116	900-450/577/1-1-1	1.856	NA	Director/D	
B.3790	Central	SUB URBAN LUDHIANA	11KV	DS DIVN. AHMEDGARH	DS S/D SIHAR	0064F02	Basari	AMR	OK	31.03.2023	Category 5-UPS				2068133	1200/577/1-1-1	2.498	NA	Director/D	
B.3791	Central	SUB URBAN LUDHIANA	11KV	DS DIVN. AHMEDGARH	DS S/D SIHAR	0064F04	Dhaul kalan	NON AMR	OK	31.03.2023	AP 3Phase 3Wire				2068062	900-450/577/1-1-1	2.708	NA	Director/D	
B.3792	Central	SUB URBAN LUDHIANA	11KV	DS DIVN. AHMEDGARH	DS S/D SIHAR	0064F05	City-1	AMR	OK	31.03.2023	Category 1				4186073	1200/577/1-1-1	4.867	NA	Director/D	
B.3793	Central	SUB URBAN LUDHIANA	11KV	DS DIVN. AHMEDGARH	DS S/D SIHAR	0064F11	Bhikki UPS	NON AMR	OK	31.03.2023	Category 5-UPS				1027323	1200/577/1-1-1	7.657	NA	Director/D	
B.3794	Central	SUB URBAN LUDHIANA	11KV	DS DIVN. AHMEDGARH	DS S/D SIHAR	0064F07	City-2	AMR	OK	31.03.2023	Category 5-UPS				5264291	900-450/577/1-1-1	10.487	NA	Director/D	
B.3795	Central	SUB URBAN LUDHIANA	11KV	DS DIVN. AHMEDGARH	DS S/U S/D NO-1 AHD	0062F19	BANWAMA SAHIB	AMR	OK	31.03.2023	AP 3Phase 3Wire				4463	Not installed	1.214	NA	Director/D	
B.3796	Central	SUB URBAN LUDHIANA	11KV	DS DIVN. AHMEDGARH	DS S/U S/D NO-1 AHD	0062F19	RAM TALAI	AMR	OK	31.03.2023	AP 3Phase 3Wire				9141052	Not installed	1.723	NA	Director/D	
B.3797	Central	SUB URBAN LUDHIANA	11KV	DS DIVN. AHMEDGARH	DS S/U S/D NO-1 AHD	0062F06	JHAMAT	AMR	OK	31.03.2023	AP 3Phase 3Wire				7042907	Not installed	2.178	NA	Director/D	
B.3798	Central	SUB URBAN LUDHIANA	11KV	DS DIVN. AHMEDGARH	DS S/U S/D NO-1 AHD	0062F21	Umarpura	AMR	OK	31.03.2023	AP 3Phase 3Wire				2066696	900-450/5	2.241	NA	Director/D	
B.3799	Central	SUB URBAN LUDHIANA	11KV	DS DIVN. AHMEDGARH	DS S/U S/D NO-1 AHD	0062F05	BEHLON	AMR	OK	31.03.2023	AP 3Phase 3Wire				8223296	Not installed	2.404	NA	Director/D	
B.3800	Central	SUB URBAN LUDHIANA	11KV	DS DIVN. AHMEDGARH	DS S/U S/D NO-1 AHD	0062F28	KAZAR FEEDER (ATHRVA)	AMR	OK	31.03.2023	Category 4				2067144	900-450/5	2.425	NA	Director/D	
B.3801	Central	SUB URBAN LUDHIANA	11KV	DS DIVN. AHMEDGARH	DS S/U S/D NO-1 AHD	0062F22	JANDALI	AMR	OK	31.03.2023	AP 3Phase 3Wire				3444	900-450/5	2.448	NA	Director/D	
B.3802	Central	SUB URBAN LUDHIANA	11KV	DS DIVN. AHMEDGARH	DS S/U S/D NO-1 AHD	0062F20	Rangan	NON AMR	OK	31.03.2023	AP 3Phase 3Wire				12093587	Not installed	2.449	NA	Director/D	
B.3803	Central	SUB URBAN LUDHIANA	11KV	DS DIVN. AHMEDGARH	DS S/U S/D NO-1 AHD	0062F03	BHOURHAI	AMR	OK	31.03.2023	AP 3Phase 3Wire				9141053	900-450/5	2.550	NA	Director/D	
B.3804	Central	SUB URBAN LUDHIANA	11KV	DS DIVN. AHMEDGARH	DS S/U S/D NO-1 AHD	0062F13	CHANNA	AMR	OK	31.03.2023	AP 3Phase 3Wire				7336696	Not installed	2.610	NA	Director/D	
B.3805	Central	SUB URBAN LUDHIANA	11KV	DS DIVN. AHMEDGARH	DS S/U S/D NO-1 AHD	0062F30	KULRAR FEEDER	AMR	OK	31.03.2023	AP 3Phase 3Wire				4240	Not installed	2.665	NA	Director/D	
B.3806	Central	SUB URBAN LUDHIANA	11KV	DS DIVN. AHMEDGARH	DS S/U S/D NO-1 AHD	0062F12	KUSUMCHIAN	NON AMR	OK	31.03.2023	Category 4				8223098	Not installed	3.522	NA	Director/D	
B.3807	Central	SUB URBAN LUDHIANA	11KV	DS DIVN. AHMEDGARH	DS S/U S/D NO-1 AHD	0062F14	UPS	NON AMR	OK	31.03.2023	Category 5-UPS				4187102	900-450/5	8.183	NA	Director/D	
B.3808	Central	SUB URBAN LUDHIANA	11KV	DS DIVN. AHMEDGARH	DS S/U S/D NO-1 AHD	0062F02	NATHLMIANA	NON AMR	OK	31.03.2023	Category 5-UPS				910177	Not installed	8.570	NA	Director/D	
B.3809	Central	SUB URBAN LUDHIANA	11KV	DS DIVN. AHMEDGARH	DS S/U S/D NO-1 AHD	0062F07	INDUSTRY	AMR	OK	31.03.2023	Category 1				52643					

S.No	Zone	Circle	Voltage Level (kVA)	Division (kVA)	Sub-Division (kVA)	Feeder ID	Feeder Name	Feeder Metering Status (Metered/unmetered/AMR/AMI)	Status of Meter (Functional/Non-Functional)	Metering Date	Date of last actual meter reading/communication	Feeder Type (Agr/Industrial/Mixed)	Status of Communication			Period from 01.04.2021 to 31.03.2022				Sales	Remarks (Source of data)
													% data received through automatically by feeder AMR/AMI	Number of hours when meter was unable to communicate in overall	Total Number of hours in the period	Meter S.No	CT/PT ratio	Import (kWh)	Export (kWh)		
B.3850	Central	SUB URBAN LUDHIANA	11KV	DS DIVN. JAGRAON	DS S/D SIDHWAN BET	FL23D056	ABUUPRA	AMR	OK	31.03.2023		AP 3Phase 3Wire				3070	1200/577/1-1-1	1.880		NA	Director/D
B.3851	Central	SUB URBAN LUDHIANA	11KV	DS DIVN. JAGRAON	DS S/D SIDHWAN BET	0056FL25	11 KV BANGSIPURA	AMR	OK	31.03.2023		AP 3Phase 3Wire				3072	900-450/577/1-1-1	2.043		NA	Director/D
B.3852	Central	SUB URBAN LUDHIANA	11KV	DS DIVN. JAGRAON	DS S/D SIDHWAN BET	0056FL01	JANDI	AMR	OK	31.03.2023		AP 3Phase 3Wire				8223691	1200/577/1-1-1	2.069		NA	Director/D
B.3853	Central	SUB URBAN LUDHIANA	11KV	DS DIVN. JAGRAON	DS S/D SIDHWAN BET	0056FL16	SADAPURA	AMR	OK	31.03.2023		AP 3Phase 3Wire				10283169	900-450/577/1-1-1	2.130		NA	Director/D
B.3854	Central	SUB URBAN LUDHIANA	11KV	DS DIVN. JAGRAON	DS S/D SIDHWAN BET	FL24D056	SODHWAL	AMR	OK	31.03.2023		AP 3Phase 3Wire				3386	1200/577/1-1-1	2.149		NA	Director/D
B.3855	Central	SUB URBAN LUDHIANA	11KV	DS DIVN. JAGRAON	DS S/D SIDHWAN BET	0056FL10	LELAN	AMR	OK	31.03.2023		AP 3Phase 3Wire				2066182	1200/577/1-1-1	2.195		NA	Director/D
B.3856	Central	SUB URBAN LUDHIANA	11KV	DS DIVN. JAGRAON	DS S/D SIDHWAN BET	0056FL20	BHAINI ARAYAN	AMR	OK	31.03.2023		AP 3Phase 3Wire				33418	900-450/577/1-1-1	2.319		NA	Director/D
B.3857	Central	SUB URBAN LUDHIANA	11KV	DS DIVN. JAGRAON	DS S/D SIDHWAN BET	0056FL05	MADAPURBA	AMR	OK	31.03.2023		AP 3Phase 3Wire				8223695	1200/577/1-1-1	2.333		NA	Director/D
B.3858	Central	SUB URBAN LUDHIANA	11KV	DS DIVN. JAGRAON	DS S/D SIDHWAN BET	0056FL04	JANET PURA	AMR	OK	31.03.2023		AP 3Phase 3Wire				4219651	1200/577/1-1-1	2.368		NA	Director/D
B.3859	Central	SUB URBAN LUDHIANA	11KV	DS DIVN. JAGRAON	DS S/D SIDHWAN BET	0056FL19	SALEMURA	AMR	OK	31.03.2023		AP 3Phase 3Wire				33464	900-450/577/1-1-1	2.367		NA	Director/D
B.3860	Central	SUB URBAN LUDHIANA	11KV	DS DIVN. JAGRAON	DS S/D SIDHWAN BET	0056FL06	PARJIAN	AMR	OK	31.03.2023		AP 3Phase 3Wire				12479516	1200/577/1-1-1	2.430		NA	Director/D
B.3861	Central	SUB URBAN LUDHIANA	11KV	DS DIVN. JAGRAON	DS S/D SIDHWAN BET	0056FL08	GIDDERWINDI	AMR	OK	31.03.2023		AP 3Phase 3Wire				12479813	900-450/577/1-1-1	2.482		NA	Director/D
B.3862	Central	SUB URBAN LUDHIANA	11KV	DS DIVN. JAGRAON	DS S/D SIDHWAN BET	0056FL02	SATIPURA	AMR	OK	31.03.2023		AP 3Phase 3Wire				8223838	1200/577/1-1-1	2.519		NA	Director/D
B.3863	Central	SUB URBAN LUDHIANA	11KV	DS DIVN. JAGRAON	DS S/D SIDHWAN BET	0056FL26	11KV Bujgar	AMR	OK	31.03.2023		AP 3Phase 3Wire				5284	900-450/577/1-1-1	2.587		NA	Director/D
B.3864	Central	SUB URBAN LUDHIANA	11KV	DS DIVN. JAGRAON	DS S/D SIDHWAN BET	0056FL17	SANGATPURA	NON AMR	OK	31.03.2023		AP 3Phase 3Wire				10288389	900-450/577/1-1-1	2.673		NA	Director/D
B.3865	Central	SUB URBAN LUDHIANA	11KV	DS DIVN. JAGRAON	DS S/D SIDHWAN BET	0056FL18	MALSIAN BAJAN	NON AMR	OK	31.03.2023		AP 3Phase 3Wire				7424141	900-450/577/1-1-1	2.705		NA	Director/D
B.3866	Central	SUB URBAN LUDHIANA	11KV	DS DIVN. JAGRAON	DS S/D SIDHWAN BET	0056FL21	BHUMAL UPS	NON AMR	OK	31.03.2023		Category 5-UPS				10288327	1200/577/1-1-1	5.910		NA	Director/D
B.3867	Central	SUB URBAN LUDHIANA	11KV	DS DIVN. JAGRAON	DS S/D SIDHWAN BET	0056FL03	SIDHWAN BET	NON AMR	OK	31.03.2023		Category 5-UPS				7424022	1200/577/1-1-1	8.282		NA	Director/D
B.3868	Central	SUB URBAN LUDHIANA	11KV	DS DIVN. JAGRAON	DS S/D SIDHWAN BET	0056FL11	SATIPURA UPS	AMR	OK	31.03.2023		Category 5-UPS				5390827	1200/577/1-1-1	8.508		NA	Director/D
B.3869	Central	SUB URBAN LUDHIANA	11KV	DS DIVN. JAGRAON	DS S/D SIDHWAN BET	0056FL13	THARA UPS	AMR	OK	31.03.2023		Category 5-UPS				9534594	900-450/577/1-1-1	9.377		NA	Director/D
B.3870	Central	SUB URBAN LUDHIANA	11KV	DS DIVN. JAGRAON	DS S/D SIDHWAN BET	0056FL09	SADAPURA UPS	AMR	OK	31.03.2023		Category 5-UPS				2062729	900-450/577/1-1-1	12.134		NA	Director/D
B.3871	Central	SUB URBAN LUDHIANA	11KV	DS DIVN. JAGRAON	DS S/D SIDHWAN KHURD	C051FL22	AP PONA	NON AMR	OK	31.03.2023		AP 3Phase 3Wire				3590	900-450/577/1-1-1	0.946		NA	Director/D
B.3872	Central	SUB URBAN LUDHIANA	11KV	DS DIVN. JAGRAON	DS S/D SIDHWAN KHURD	C051FL12	BARSAI	NON AMR	OK	31.03.2023		AP 3Phase 3Wire				18	900-450/577/1-1-1	1.010		NA	Director/D
B.3873	Central	SUB URBAN LUDHIANA	11KV	DS DIVN. JAGRAON	DS S/D SIDHWAN KHURD	C051FL14	Sidhwan kalan	NON AMR	OK	31.03.2023		AP 3Phase 3Wire				9153381	900-450/577/1-1-1	1.657		NA	Director/D
B.3874	Central	SUB URBAN LUDHIANA	11KV	DS DIVN. JAGRAON	DS S/D SIDHWAN KHURD	C051FL02	KROWKIMANN	NON AMR	OK	31.03.2023		AP 3Phase 3Wire				111	1200/577/1-1-1	2.132		NA	Director/D
B.3875	Central	SUB URBAN LUDHIANA	11KV	DS DIVN. JAGRAON	DS S/D SIDHWAN KHURD	C051FL03	GUREN	NON AMR	OK	31.03.2023		AP 3Phase 3Wire				1200/577/1-1-1	2.164		NA	Director/D	
B.3876	Central	SUB URBAN LUDHIANA	11KV	DS DIVN. JAGRAON	DS S/D SIDHWAN KHURD	C051FL06	VIRK	NON AMR	OK	31.03.2023		AP 3Phase 3Wire				11069766	900-450/577/1-1-1	2.202		NA	Director/D
B.3877	Central	SUB URBAN LUDHIANA	11KV	DS DIVN. JAGRAON	DS S/D SIDHWAN KHURD	C051FL01	SIDHWAN-KHURD	NON AMR	OK	31.03.2023		AP 3Phase 3Wire				107	1200/577/1-1-1	2.551		NA	Director/D
B.3878	Central	SUB URBAN LUDHIANA	11KV	DS DIVN. JAGRAON	DS S/D SIDHWAN KHURD	C051FL11	PABIAN	NON AMR	OK	31.03.2023		Category 5-UPS				9534405	900-450/577/1-1-1	9.842		NA	Director/D
B.3879	Central	SUB URBAN LUDHIANA	11KV	DS DIVN. JAGRAON	DS S/D SIDHWAN KHURD	8053FL19	AMRIT OIL	AMR	OK	31.03.2023		Category 4				12479272	1200/577/1-1-1	0.865		NA	Director/D
B.3880	Central	SUB URBAN LUDHIANA	11KV	DS DIVN. JAGRAON	DS S/D SIDHWAN KHURD	8053FL11	MILL-NO.3	NON AMR	OK	31.03.2023		Category 1				12479712	1200/577/1-1-1	12.532		NA	Director/D
B.3881	Central	SUB URBAN LUDHIANA	11KV	DS DIVN. JAGRAON	DS S/D SIDHWAN KHURD	0070FL10	ET University	NON AMR	OK	31.03.2023		Category 3				16198467	1200/577/1-1-1	1.238		NA	Director/D
B.3882	Central	SUB URBAN LUDHIANA	11KV	DS DIVN. JAGRAON	DS S/D SIDHWAN KHURD	0070FL02	SOHAN	NON AMR	OK	31.03.2023		AP 3Phase 3Wire				8222636	900-450/577/1-1-1	2.334		NA	Director/D
B.3883	Central	SUB URBAN LUDHIANA	11KV	DS DIVN. JAGRAON	DS S/D SIDHWAN KHURD	0070FL03	KAMBASAR	AMR	OK	31.03.2023		AP 3Phase 3Wire				23307	900-450/577/1-1-1	2.417		NA	Director/D
B.3884	Central	SUB URBAN LUDHIANA	11KV	DS DIVN. JAGRAON	DS S/D SIDHWAN KHURD	0070FL01	KOTHE HANS	AMR	OK	31.03.2023		Category 5-UPS				12479343	900-450/577/1-1-1	8.707		NA	Director/D
B.3885	Central	SUB URBAN LUDHIANA	11KV	DS DIVN. JAGRAON	DS S/U S/D JAGRAON	8053FL20	Civil Hospital JAGRAON	NON AMR	OK	31.03.2023		Category 3				33526	1200/577/1-1-1	0.331		NA	Director/D
B.3886	Central	SUB URBAN LUDHIANA	11KV	DS DIVN. JAGRAON	DS S/U S/D JAGRAON	8053FL07	SHEPUR	NON AMR	OK	31.03.2023		AP 3Phase 3Wire				33526	900-450/577/1-1-1	1.765		NA	Director/D
B.3887	Central	SUB URBAN LUDHIANA	11KV	DS DIVN. JAGRAON	DS S/U S/D JAGRAON	8053FL15	CHIMNA	NON AMR	OK	31.03.2023		AP 3Phase 3Wire				8222436	1200/577/1-1-1	1.849		NA	Director/D
B.3888	Central	SUB URBAN LUDHIANA	11KV	DS DIVN. JAGRAON	DS S/U S/D JAGRAON	8053FL16	KALUNKE-2	AMR	OK	31.03.2023		AP 3Phase 3Wire				23449	900-450/577/1-1-1	1.985		NA	Director/D
B.3889	Central	SUB URBAN LUDHIANA	11KV	DS DIVN. JAGRAON	DS S/U S/D JAGRAON	8053FL09	GAGRA	AMR	OK	31.03.2023		AP 3Phase 3Wire				9140924	1200/577/1-1-1	2.153		NA	Director/D
B.3890	Central	SUB URBAN LUDHIANA	11KV	DS DIVN. JAGRAON	DS S/U S/D JAGRAON	8053FL13	KALUNKE-1	AMR	OK	31.03.2023		AP 3Phase 3Wire				8223179	1200/577/1-1-1	2.245		NA	Director/D
B.3891	Central	SUB URBAN LUDHIANA	11KV	DS DIVN. JAGRAON	DS S/U S/D JAGRAON	8053FL06	NANAKSAR	NON AMR	OK	31.03.2023		AP 3Phase 3Wire				8222437	1200/577/1-1-1	3.002		NA	Director/D
B.3892	Central	SUB URBAN LUDHIANA	11KV	DS DIVN. JAGRAON	DS S/U S/D JAGRAON	8053FL21	KOTHE PONA	AMR	OK	31.03.2023		AP 3Phase 3Wire				6740714	1200/577/1-1-1	2.820		NA	Director/D
B.3893	Central	SUB URBAN LUDHIANA	11KV	DS DIVN. JAGRAON	DS S/U S/D JAGRAON	8053FL05	BARSAI	AMR	OK	31.03.2023		AP 3Phase 3Wire				8223720	1200/577/1-1-1	4.708		NA	Director/D
B.3894	Central	SUB URBAN LUDHIANA	11KV	DS DIVN. JAGRAON	DS S/U S/D JAGRAON	8053FL18	REFINERY	NON AMR	OK	31.03.2023		Category 3				12479713	1200/577/1-1-1	6.922		NA	Director/D
B.3895	Central	SUB URBAN LUDHIANA	11KV	DS DIVN. JAGRAON	DS S/U S/D JAGRAON	8053FL03	MILL-2	AMR	OK	31.03.2023		Category 1				12479280	1200/577/1-1-1	11.247		NA	Director/D
B.3896	Central	SUB URBAN LUDHIANA	11KV	DS DIVN. JAGRAON	DS S/U S/D JAGRAON	8053FL04	BODALWALA	NON AMR	OK	31.03.2023		Category 5-UPS				8222440	1200/577/1-1-1	12.772		NA	Director/D
B.3897	Central	SUB URBAN LUDHIANA	11KV	DS DIVN. JAGRAON	DS S/U S/D JAGRAON	8053FL12	MILL-NO.1	AMR	OK	31.03.2023		Category 1				12479285	1200/577/1-1-1	13.265		NA	Director/D
B.3898	Central	SUB URBAN LUDHIANA	11KV	DS DIVN. JAGRAON	DS S/U S/D JAGRAON	0068FL16	Bi-Ganga	AMR	OK	31.03.2023		AP 3Phase 3Wire				4846	1200-600/5	1.217		NA	Director/D
B.3899	Central	SUB URBAN LUDHIANA	11KV	DS DIVN. JAGRAON	DS S/U S/D JAGRAON	FL15D068	11 KV NANAKSAR-3	AMR	OK	31.03.2023		AP 3Phase 3Wire				3206	1200-600/5	1.598		NA	Director/D
B.3900	Central	SUB URBAN LUDHIANA	11KV	DS DIVN. JAGRAON	DS S/U S/D JAGRAON	0068FL17	Gurusar Kaunke UPS	AMR	OK	31.03.2023		Category 5-UPS				6132	1200-600/5	1.831		NA	Director/D
B.3901	Central	SUB URBAN LUDHIANA	11KV	DS DIVN. JAGRAON	DS S/U S/D JAGRAON	0068FL14	AGWAR LOPON 3	AMR	OK	31.03.2023		AP 3Phase 3Wire				15192346	900-450/577/1-1-1	1.958		NA	Director/D
B.3902	Central	SUB URBAN LUDHIANA	11KV	DS DIVN. JAGRAON	DS S/U S/D JAGRAON	0068FL01	AGWAR-DALLA	AMR	OK	31.03.2023		AP 3Phase 3Wire				9140923	1200-600/5	2.			

S.No	Zone	Circle	Voltage Level (kVA)	Division (kVA)	Sub-Division (kVA)	Feeder ID	Feeder Name	Feeder Metering Status (Metered/unmetered/AMR/AMI)	Status of Meter (Functional/Non-Functional)	Metering Date (Date of last actual meter reading/communication)	Feeder Type (Agr/Industrial/Mixed)	Status of Communication			Period from 01.04.2021 to 31.03.2022				Sales	Remarks (Source of data)
												% Data received through automatically by feeder AMR/AMI	Number of hours when meter was unable to communicate in overall	Total Number of hours in the period	Meter S.No	CT/PT ratio	Import (kU)	Export (kU)		
B.3947	Central	SUB URBAN LUDHIANA	11kV	DS DIVN. RAIKOT	DS S/D BASSIAN	D069F08	istawal	NON AMR	OK	31.03.2023	AP 3Phase 3Wire				15194651	900-450/577/1-1-1	2.398	NA	Director/D	
B.3948	Central	SUB URBAN LUDHIANA	11kV	DS DIVN. RAIKOT	DS S/D BASSIAN	D069F16	Baba Surta Singh	NON AMR	OK	31.03.2023	AP 3Phase 3Wire				20679926	900-450/577/1-1-1	2.584	NA	Director/D	
B.3949	Central	SUB URBAN LUDHIANA	11kV	DS DIVN. RAIKOT	DS S/D BASSIAN	D069F11	Sekani	AMR	OK	31.03.2023	AP 3Phase 3Wire				120197920	900-450/577/1-1-1	2.756	NA	Director/D	
B.3950	Central	SUB URBAN LUDHIANA	11kV	DS DIVN. RAIKOT	DS S/D BASSIAN	D069F14	Dhurotk	AMR	OK	31.03.2023	AP 3Phase 3Wire				9102328	900-450/577/1-1-1	2.851	NA	Director/D	
B.3951	Central	SUB URBAN LUDHIANA	11kV	DS DIVN. RAIKOT	DS S/D BASSIAN	D069F04	Shahpur	AMR	OK	31.03.2023	AP 3Phase 3Wire				12479848	900-450/577/1-1-1	2.939	NA	Director/D	
B.3952	Central	SUB URBAN LUDHIANA	11kV	DS DIVN. RAIKOT	DS S/D BASSIAN	D069F03	Bassian Babe Sahidan	NON AMR	OK	31.03.2023	AP 3Phase 3Wire				12479385	900-450/577/1-1-1	2.949	NA	Director/D	
B.3953	Central	SUB URBAN LUDHIANA	11kV	DS DIVN. RAIKOT	DS S/D BASSIAN	D069F10	Bopari Khurd	AMR	OK	31.03.2023	AP 3Phase 3Wire				20198000	900-450/577/1-1-1	2.964	NA	Director/D	
B.3954	Central	SUB URBAN LUDHIANA	11kV	DS DIVN. RAIKOT	DS S/D BASSIAN	D069F12	Rangharv khyan	AMR	OK	31.03.2023	AP 3Phase 3Wire				220197929	900-450/577/1-1-1	3.245	NA	Director/D	
B.3955	Central	SUB URBAN LUDHIANA	11kV	DS DIVN. RAIKOT	DS S/D BASSIAN	D069F02	Bassian Urban	NON AMR	OK	31.03.2023	Category 5-UPS				3866	900-450/577/1-1-1	9.177	NA	Director/D	
B.3956	Central	SUB URBAN LUDHIANA	11kV	DS DIVN. RAIKOT	DS S/D BASSIAN	D069F01	Nahowal Urban	AMR	OK	31.03.2023	Category 5-UPS				12091587	900-450/577/1-1-1	10.326	NA	Director/D	
B.3957	Central	SUB URBAN LUDHIANA	11kV	DS DIVN. RAIKOT	DS S/D LAKHA	D067F08	Gagewal	AMR	OK	31.03.2023	AP 3Phase 3Wire				3077	1200/577/1-1-1	1.617	NA	Director/D	
B.3958	Central	SUB URBAN LUDHIANA	11kV	DS DIVN. RAIKOT	DS S/D LAKHA	D072F11	Chhinwal UPS	AMR	OK	31.03.2023	Category 5-UPS				4768	1200/577/1-1-1	1.950	NA	Director/D	
B.3959	Central	SUB URBAN LUDHIANA	11kV	DS DIVN. RAIKOT	DS S/D LAKHA	D072F10	Saidowal AP	AMR	OK	31.03.2023	AP 3Phase 3Wire				10273763	1200/577/1-1-1	2.152	NA	Director/D	
B.3960	Central	SUB URBAN LUDHIANA	11kV	DS DIVN. RAIKOT	DS S/D LAKHA	D072F09	DIWANA	NON AMR	OK	31.03.2023	AP 3Phase 3Wire				3073	1200/577/1-1-1	2.178	NA	Director/D	
B.3961	Central	SUB URBAN LUDHIANA	11kV	DS DIVN. RAIKOT	DS S/D LAKHA	D072F02	CHHINWAL KHURD	NON AMR	OK	31.03.2023	AP 3Phase 3Wire				34023	1200/577/1-1-1	2.511	NA	Director/D	
B.3962	Central	SUB URBAN LUDHIANA	11kV	DS DIVN. RAIKOT	DS S/D LAKHA	D072F04	Buraj kulr	NON AMR	OK	31.03.2023	AP 3Phase 3Wire				33999	1200/577/1-1-1	2.690	NA	Director/D	
B.3963	Central	SUB URBAN LUDHIANA	11kV	DS DIVN. RAIKOT	DS S/D LAKHA	D072F05	Naranghar Solian	AMR	OK	31.03.2023	AP 3Phase 3Wire				34034	1200/577/1-1-1	2.870	NA	Director/D	
B.3964	Central	SUB URBAN LUDHIANA	11kV	DS DIVN. RAIKOT	DS S/D LAKHA	D072F06	Diwana	AMR	OK	31.03.2023	Category 1				34020	1200/577/1-1-1	3.425	NA	Director/D	
B.3965	Central	SUB URBAN LUDHIANA	11kV	DS DIVN. RAIKOT	DS S/D LAKHA	D072F03	Gehlan	AMR	OK	31.03.2023	AP 3Phase 3Wire				3078	1200/577/1-1-1	4.898	NA	Director/D	
B.3966	Central	SUB URBAN LUDHIANA	11kV	DS DIVN. RAIKOT	DS S/D LAKHA	D072F07	Chandiana Sahib	AMR	OK	31.03.2023	Category 5-UPS				3079	1200/577/1-1-1	4.023	NA	Director/D	
B.3967	Central	SUB URBAN LUDHIANA	11kV	DS DIVN. RAIKOT	DS S/D LAKHA	D069F24	Dhwana New	AMR	OK	31.03.2023	AP 3Phase 3Wire				23577	1200/577/1-1-1	1.105	NA	Director/D	
B.3968	Central	SUB URBAN LUDHIANA	11kV	DS DIVN. RAIKOT	DS S/D LAKHA	D069F12	LAKHA(AP)	AMR	OK	31.03.2023	AP 3Phase 3Wire				9140925	1200/577/1-1-1	1.995	NA	Director/D	
B.3969	Central	SUB URBAN LUDHIANA	11kV	DS DIVN. RAIKOT	DS S/D LAKHA	D069F11	GEHAL	AMR	OK	31.03.2023	AP 3Phase 3Wire				8223319	1200/577/1-1-1	2.211	NA	Director/D	
B.3970	Central	SUB URBAN LUDHIANA	11kV	DS DIVN. RAIKOT	DS S/D LAKHA	D069F07	HATHUR	AMR	OK	31.03.2023	AP 3Phase 3Wire				8223318	1200/577/1-1-1	2.432	NA	Director/D	
B.3971	Central	SUB URBAN LUDHIANA	11kV	DS DIVN. RAIKOT	DS S/D LAKHA	D069F18	BURAJ KULARA	AMR	OK	31.03.2023	AP 3Phase 3Wire				9154319	1200/577/1-1-1	2.625	NA	Director/D	
B.3972	Central	SUB URBAN LUDHIANA	11kV	DS DIVN. RAIKOT	DS S/D LAKHA	D069F13	CHAKKAR NO. 2	AMR	OK	31.03.2023	AP 3Phase 3Wire				8223209	1200/577/1-1-1	2.627	NA	Director/D	
B.3973	Central	SUB URBAN LUDHIANA	11kV	DS DIVN. RAIKOT	DS S/D LAKHA	D069F16	CHHINWAL	AMR	OK	31.03.2023	AP 3Phase 3Wire				12479608	1200/577/1-1-1	2.763	NA	Director/D	
B.3974	Central	SUB URBAN LUDHIANA	11kV	DS DIVN. RAIKOT	DS S/D LAKHA	D069F03	MANUKE NO. 1	AMR	OK	31.03.2023	AP 3Phase 3Wire				8223317	1200/577/1-1-1	2.871	NA	Director/D	
B.3975	Central	SUB URBAN LUDHIANA	11kV	DS DIVN. RAIKOT	DS S/D LAKHA	D069F04	CHAKKAR NO. 1	AMR	OK	31.03.2023	AP 3Phase 3Wire				8223320	1200/577/1-1-1	3.139	NA	Director/D	
B.3976	Central	SUB URBAN LUDHIANA	11kV	DS DIVN. RAIKOT	DS S/D LAKHA	D069F01	GAGEWAL UPS	AMR	OK	31.03.2023	Category 5-UPS				2067104	1200/577/1-1-1	3.594	NA	Director/D	
B.3977	Central	SUB URBAN LUDHIANA	11kV	DS DIVN. RAIKOT	DS S/D LAKHA	D069F19	MANUKE NO.3	AMR	OK	31.03.2023	AP 3Phase 3Wire				10282980	1200/577/1-1-1	4.000	NA	Director/D	
B.3978	Central	SUB URBAN LUDHIANA	11kV	DS DIVN. RAIKOT	DS S/D LAKHA	D069F18	DIWANA	NON AMR	OK	31.03.2023	AP 3Phase 3Wire				8223481	1200/577/1-1-1	4.601	NA	Director/D	
B.3979	Central	SUB URBAN LUDHIANA	11kV	DS DIVN. RAIKOT	DS S/D LAKHA	D069F22	Chakkar No. 3	NON AMR	OK	31.03.2023	AP 3Phase 3Wire				23594	1200/577/1-1-1	4.966	NA	Director/D	
B.3980	Central	SUB URBAN LUDHIANA	11kV	DS DIVN. RAIKOT	DS S/D LAKHA	D069F23	CHHINWAL NEW	AMR	OK	31.03.2023	AP 3Phase 3Wire				36753	1200/577/1-1-1	5.042	NA	Director/D	
B.3981	Central	SUB URBAN LUDHIANA	11kV	DS DIVN. RAIKOT	DS S/D LAKHA	D069F17	MANUKE NO.2	AMR	OK	31.03.2023	AP 3Phase 3Wire				9534585	1200/577/1-1-1	5.094	NA	Director/D	
B.3982	Central	SUB URBAN LUDHIANA	11kV	DS DIVN. RAIKOT	DS S/D LAKHA	FL28D060	MANUKE URBAN	AMR	OK	31.03.2023	Category 5-UPS				12479607	1200/577/1-1-1	7.494	NA	Director/D	
B.3983	Central	SUB URBAN LUDHIANA	11kV	DS DIVN. RAIKOT	DS S/D LAKHA	D069F10	LAKHA(UPS)	AMR	OK	31.03.2023	Category 5-UPS				23114	1200/577/1-1-1	9.274	NA	Director/D	
B.3984	Central	SUB URBAN LUDHIANA	11kV	DS DIVN. RAIKOT	DS S/D LAKHA	D069F04	HATHUR(UPS)	NON AMR	OK	31.03.2023	Category 5-UPS				10282864	1200/577/1-1-1	10.986	NA	Director/D	
B.3985	Central	SUB URBAN LUDHIANA	11kV	DS DIVN. RAIKOT	DS S/D LAKHA	D024F14	GEHLAN NEW	NON AMR	OK	31.03.2023	AP 3Phase 3Wire				24292	900-450/577/1-1-1	0.000	NA	Director/D	
B.3986	Central	SUB URBAN LUDHIANA	11kV	DS DIVN. RAIKOT	DS S/D LAKHA	D024F13	GEHLAN OLD	AMR	OK	31.03.2023	AP 3Phase 3Wire				24292	900-450/577/1-1-1	4.028	NA	Director/D	
B.3987	Central	SUB URBAN LUDHIANA	11kV	DS DIVN. RAIKOT	DS S/D RAIKOT	D067F14	TALWANDI-AP	NON AMR	OK	31.03.2023	AP 3Phase 3Wire				10288350	1200-600/5	3.249	NA	Director/D	
B.3988	Central	SUB URBAN LUDHIANA	11kV	DS DIVN. RAIKOT	DS S/D RAIKOT	D067F11	MANJI SAHIB	NON AMR	OK	31.03.2023	AP 3Phase 3Wire				33429	900-450/577/1-1-1	4.161	NA	Director/D	
B.3989	Central	SUB URBAN LUDHIANA	11kV	DS DIVN. RAIKOT	DS S/D RAIKOT	D067F06	TALWANDI UPS	AMR	OK	31.03.2023	Category 5-UPS				9154157	900-450/577/1-1-1	4.074	NA	Director/D	
B.3990	Central	SUB URBAN LUDHIANA	11kV	DS DIVN. RAIKOT	DS S/D RAIKOT	D069F03	JOULHAN	AMR	OK	31.03.2023	AP 3Phase 3Wire				34045	1200-600/5	1.228	NA	Director/D	
B.3991	Central	SUB URBAN LUDHIANA	11kV	DS DIVN. RAIKOT	DS S/D RAIKOT	D069F07	KUTBA2	AMR	OK	31.03.2023	Category 5-UPS				5295650	900-450/577/1-1-1	1.024	NA	Director/D	
B.3992	Central	SUB URBAN LUDHIANA	11kV	DS DIVN. RAIKOT	DS S/D RAIKOT	D069F09	GOBINDGARH	AMR	OK	31.03.2023	AP 3Phase 3Wire				7336752	1200-600/5	2.719	NA	Director/D	
B.3993	Central	SUB URBAN LUDHIANA	11kV	DS DIVN. RAIKOT	DS S/D RAIKOT	D069F01	KUTBA1	AMR	OK	31.03.2023	AP 3Phase 3Wire				8222910	1200-600/5	2.725	NA	Director/D	
B.3994	Central	SUB URBAN LUDHIANA	11kV	DS DIVN. RAIKOT	DS S/D RAIKOT	D069F02	HANDEPUR	AMR	OK	31.03.2023	AP 3Phase 3Wire				3202987	1200-600/5	3.066	NA	Director/D	
B.3995	Central	SUB URBAN LUDHIANA	11kV	DS DIVN. RAIKOT	DS S/D RAIKOT	D069F11	DADAHRI	AMR	OK	31.03.2023	AP 3Phase 3Wire				7368819	900-450/577/1-1-1	3.412	NA	Director/D	
B.3996	Central	SUB URBAN LUDHIANA	11kV	DS DIVN. RAIKOT	DS S/D RAIKOT	D069F06	SEHBAPURA	AMR	OK	31.03.2023	AP 3Phase 3Wire				43182	900-450/577/1-1-1	3.972	NA	Director/D	
B.3997	Central	SUB URBAN LUDHIANA	11kV	DS DIVN. RAIKOT	DS S/D RAIKOT	D069F12	SULTAN KHA WALA	AMR	OK	31.03.2023	AP 3Phase 3Wire				10283038	1200-600/5	4.318	NA	Director/D	
B.3998	Central	SUB URBAN LUDHIANA	11kV	DS DIVN. RAIKOT	DS S/D RAIKOT	D059F30	Civil Hospital	AMR	OK	31.03.2023	Category 4				12479255	1200/577/1-1-1	0.265	NA	Director/D	
B.3999	Central	SUB URBAN LUDHIANA	11kV	DS DIVN. RAIKOT	DS S/D RAIKOT	D059F18	BURI HARI SINGH	AMR	OK	31.03.2023	Category 5-UPS				4262812	1200/577/1-1-1	1.050	NA	Director/D	
B.4000	Central	SUB URBAN LUDHIANA	11kV	DS DIVN. RAIKOT	DS S/D RAIKOT	D059F18	Kothi Multanpuria	AMR	OK	31.03.2023	AP 3Phase 3Wire				4155	1200/577/1-1-1	3.779	NA	Director/D	
B.4001	Central	SUB URBAN LUDHIANA	11kV	DS DIVN. RAIKOT	DS S/D RAIKOT	D059F25	Kothi Sobha singh	AMR	OK	31.03.2023	AP 3Phase 3Wire				12479484	1200/577/1-1-1	1.820	NA	Director/D	
B.4002	Central	SUB URBAN LUDHIANA	11kV	DS DIVN. RAIKOT	DS S/D RAIKOT	D059F15	DADHAUR	AMR	OK	31.03.2023	AP 3Phase 3Wire									

S.No	Zone	Circle	Voltage Level (kVA)	Division (kVA)	Sub-Division (kVA)	Feeder ID	Feeder Name	Feeder Metering Status (Metered/unmetered/AMR/AMI)	Status of Meter (Functional/Non-Functional)	Metering Date (Date of last actual meter reading/communication)	Feeder Type (Agr/Industrial/Mixed)	Status of Communication			Period from 01.04.2021 to 31.03.2022				Sales	Remarks (Source of data)
												% data received through automatically by feeder AMR/AMI	Number of hours when meter was unable to communicate in overall	Total Number of hours in the period	Meter S.No	CT/PT ratio	Import (kWh)	Export (kWh)		
B.4044	Central	SUB URBAN LUDHIANA	11kV	DS DIVN. RAIKOT	DS S/D ROOMI	D061F08	HANSKALAN	NON AMR	OK	31.03.2023	AP 3Phase 3Wire				8223790	900-450/5	2.255	NA	Director/D	
B.4045	Central	SUB URBAN LUDHIANA	11kV	DS DIVN. RAIKOT	DS S/D ROOMI	D061F16	Akhara AP	AMR	OK	31.03.2023	AP 3Phase 3Wire				2066919	1200-600/5	2.578	NA	Director/D	
B.4046	Central	SUB URBAN LUDHIANA	11kV	DS DIVN. RAIKOT	DS S/D ROOMI	D061F17	Kothie Prem SAR	AMR	OK	31.03.2023	AP 3Phase 3Wire				2068374	1200-600/5	2.742	NA	Director/D	
B.4047	Central	SUB URBAN LUDHIANA	11kV	DS DIVN. RAIKOT	DS S/D ROOMI	D061F07	KAMAL PURA	AMR	OK	31.03.2023	AP 3Phase 3Wire				8223789	900-450/5	3.238	NA	Director/D	
B.4048	Central	SUB URBAN LUDHIANA	11kV	DS DIVN. RAIKOT	DS S/D ROOMI	D061F101	RANDHIGARH	AMR	OK	31.03.2023	AP 3Phase 3Wire				12479676	900-450/5	3.694	NA	Director/D	
B.4049	Central	SUB URBAN LUDHIANA	11kV	DS DIVN. RAIKOT	DS S/D ROOMI	D061F120	11KV BHAMMIPURA AP	AMR	OK	31.03.2023	AP 3Phase 3Wire				73171269	900-450/5	3.802	NA	Director/D	
B.4050	Central	SUB URBAN LUDHIANA	11kV	DS DIVN. RAIKOT	DS S/D ROOMI	D061F02	CHAJEWA	AMR	OK	31.03.2023	AP 3Phase 3Wire				10288323	1200-600/5	3.943	NA	Director/D	
B.4051	Central	SUB URBAN LUDHIANA	11kV	DS DIVN. RAIKOT	DS S/D ROOMI	D061F11	CHEEMA	AMR	OK	31.03.2023	AP 3Phase 3Wire				2061458	900-450/5	4.018	NA	Director/D	
B.4052	Central	SUB URBAN LUDHIANA	11kV	DS DIVN. RAIKOT	DS S/D ROOMI	D061F06	ROOMI SUB URBAN	NON AMR	OK	31.03.2023	AP 3Phase 3Wire				2064384	900-450/5	4.305	NA	Director/D	
B.4053	Central	SUB URBAN LUDHIANA	11kV	DS DIVN. RAIKOT	DS S/D ROOMI	D061F12	BHAMMIPURA URBAN	AMR	OK	31.03.2023	Category 5 UPS				9154111	1200-600/5	5.465	NA	Director/D	
B.4054	Central	SUB URBAN LUDHIANA	11kV	DS DIVN. RAIKOT	DS S/D ROOMI	D061F121	11KV KAMALPURA UPS	NON AMR	OK	31.03.2023	Category 5 UPS				73171270	1200-600/5	7.021	NA	Director/D	
B.4055	Central	SUB URBAN LUDHIANA	11kV	DS DIVN. RAIKOT	DS S/D ROOMI	D061F04	ROOMI URBAN	AMR	OK	31.03.2023	Category 5 UPS				2047100	900-450/5	9.864	NA	Director/D	
B.4056	Central	SUB URBAN LUDHIANA	11kV	DS S/U DIVN. LALTON	KDS S/D LALTON KALAN	8051FL	Khandoor Road	NON AMR	OK	31.03.2023	AP 3Phase 3Wire				10288302	900-450/5	1.003	NA	Director/D	
B.4057	Central	SUB URBAN LUDHIANA	11kV	DS S/U DIVN. LALTON	KDS S/D LALTON KALAN	8051FL15	Joshan	AMR	OK	31.03.2023	AP 3Phase 3Wire				4186572	900-450/5	1.828	NA	Director/D	
B.4058	Central	SUB URBAN LUDHIANA	11kV	DS S/U DIVN. LALTON	KDS S/D LALTON KALAN	8051FL09	Chokhan	AMR	OK	31.03.2023	AP 3Phase 3Wire				12479288	900-450/5	1.885	NA	Director/D	
B.4059	Central	SUB URBAN LUDHIANA	11kV	DS S/U DIVN. LALTON	KDS S/D LALTON KALAN	8051FL11	Kheri	AMR	OK	31.03.2023	AP 3Phase 3Wire				15192330	900-450/5	2.504	NA	Director/D	
B.4060	Central	SUB URBAN LUDHIANA	11kV	DS S/U DIVN. LALTON	KDS S/D LALTON KALAN	8051FL16	MANSURAN	AMR	OK	31.03.2023	AP 3Phase 3Wire				9141167	900-450/5	2.633	NA	Director/D	
B.4061	Central	SUB URBAN LUDHIANA	11kV	DS S/U DIVN. LALTON	KDS S/D LALTON KALAN	8051FL	Mandir	AMR	OK	31.03.2023	Category 5 UPS				6679931	900-450/5	2.773	NA	Director/D	
B.4062	Central	SUB URBAN LUDHIANA	11kV	DS S/U DIVN. LALTON	KDS S/D LALTON KALAN	8051FL01	Saad	AMR	OK	31.03.2023	AP 3Phase 3Wire				4186560	900-450/5	2.817	NA	Director/D	
B.4063	Central	SUB URBAN LUDHIANA	11kV	DS S/U DIVN. LALTON	KDS S/D LALTON KALAN	8051FL02	Pajral	NON AMR	OK	31.03.2023	AP 3Phase 3Wire				9140972	900-450/5	2.866	NA	Director/D	
B.4064	Central	SUB URBAN LUDHIANA	11kV	DS S/U DIVN. LALTON	KDS S/D LALTON KALAN	8051FL03	Jhaneri	NON AMR	OK	31.03.2023	AP 3Phase 3Wire				11116819	900-450/5	3.373	NA	Director/D	
B.4065	Central	SUB URBAN LUDHIANA	11kV	DS S/U DIVN. LALTON	KDS S/D LALTON KALAN	8051FL06	Lalton	AMR	OK	31.03.2023	AP 3Phase 3Wire				11116944	900-450/5	3.842	NA	Director/D	
B.4066	Central	SUB URBAN LUDHIANA	11kV	DS S/U DIVN. LALTON	KDS S/D LALTON KALAN	8051FL10	New Pamal	AMR	OK	31.03.2023	Category 5 UPS				5295558	900-450/5	5.333	NA	Director/D	
B.4067	Central	SUB URBAN LUDHIANA	11kV	DS S/U DIVN. LALTON	KDS S/D LALTON KALAN	8051FL07	Thakkarwal	AMR	OK	31.03.2023	Category 1				4186560	900-450/5	8.018	NA	Director/D	
B.4068	Central	SUB URBAN LUDHIANA	11kV	DS S/U DIVN. LALTON	KDS S/D LALTON KALAN	8051FL14	Bolon (LIPS)	AMR	OK	31.03.2023	Category 5 UPS				10288308	900-450/5	8.393	NA	Director/D	
B.4069	Central	SUB URBAN LUDHIANA	11kV	DS S/U DIVN. LALTON	KDS S/D LALTON KALAN	8051FL08	Mid Land	AMR	OK	31.03.2023	Category 1				10288302	900-450/5	10.235	NA	Director/D	
B.4070	Central	SUB URBAN LUDHIANA	11kV	DS S/U DIVN. LALTON	KDS S/D LALTON KALAN	8051FL05	Industry	AMR	OK	31.03.2023	Category 1				4186562	900-450/5	12.800	NA	Director/D	
B.4071	Central	SUB URBAN LUDHIANA	11kV	DS S/U DIVN. LALTON	KDS S/D LALTON KALAN	D034FL06	Dad	AMR	OK	31.03.2023	AP 3Phase 3Wire				33738	1200-600/5	2.713	NA	Director/D	
B.4072	Central	SUB URBAN LUDHIANA	11kV	DS S/U DIVN. LALTON	KDS S/D LALTON KALAN	D034FL05	ROSE ENCLAVE	AMR	OK	31.03.2023	Category 1				2066094	1200-600/5	9.729	NA	Director/D	
B.4073	Central	SUB URBAN LUDHIANA	11kV	DS S/U DIVN. LALTON	KDS S/D LALTON KALAN	D034FL01	Palam Vihar	AMR	OK	31.03.2023	Category 1				33732	1200-600/5	13.417	NA	Director/D	
B.4074	Central	SUB URBAN LUDHIANA	11kV	DS S/U DIVN. LALTON	KDS S/D LALTON KALAN	D052FL15	Joshan (Narangwal)	Not available	OK	31.03.2023	AP 3Phase 3Wire				12548	900-450/577/1-1	2.279	NA	Director/D	
B.4075	Central	SUB URBAN LUDHIANA	11kV	DS S/U DIVN. LALTON	KDS S/D NARANGWAL	D052FL01	Nahar Export	AMR	OK	31.03.2023	Category 4				Not available	Not available	60.152	NA	Director/D	
B.4076	Central	SUB URBAN LUDHIANA	11kV	DS S/U DIVN. LALTON	KDS S/D NARANGWAL	D054FL11	Dangon	AMR	OK	31.03.2023	AP 3Phase 3Wire				2066560	1200-600/5	2.082	NA	Director/D	
B.4077	Central	SUB URBAN LUDHIANA	11kV	DS S/U DIVN. LALTON	KDS S/D NARANGWAL	D065FL24	JUDHAN	AMR	OK	31.03.2023	AP 3Phase 3Wire				4678	900-450/5	2.210	NA	Director/D	
B.4078	Central	SUB URBAN LUDHIANA	11kV	DS S/U DIVN. LALTON	KDS S/D NARANGWAL	D065FL25	Mehma Singh Wala	AMR	OK	31.03.2023	AP 3Phase 3Wire				5946	900-450/577/1-1	0.270	NA	Director/D	
B.4079	Central	SUB URBAN LUDHIANA	11kV	DS S/U DIVN. LALTON	KDS S/D NARANGWAL	D065FL24	Paola Bearings	AMR	OK	31.03.2023	Category 2				5939	900-450/577/1-1	0.362	NA	Director/D	
B.4080	Central	SUB URBAN LUDHIANA	11kV	DS S/U DIVN. LALTON	KDS S/D NARANGWAL	D052FL18	KSI	AMR	OK	31.03.2023	AP 3Phase 3Wire				9003338	900-450/577/1-1	2.076	NA	Director/D	
B.4081	Central	SUB URBAN LUDHIANA	11kV	DS S/U DIVN. LALTON	KDS S/D NARANGWAL	D052FL07	Kla Rajpur	AMR	OK	31.03.2023	AP 3Phase 3Wire				8223515	900-450/577/1-1	2.288	NA	Director/D	
B.4082	Central	SUB URBAN LUDHIANA	11kV	DS S/U DIVN. LALTON	KDS S/D NARANGWAL	D052FL21	DOLON	AMR	OK	31.03.2023	AP 3Phase 3Wire				73210578	900-450/577/1-1	2.318	NA	Director/D	
B.4083	Central	SUB URBAN LUDHIANA	11kV	DS S/U DIVN. LALTON	KDS S/D NARANGWAL	D052FL05	Gujarwal	AMR	OK	31.03.2023	AP 3Phase 3Wire				8223157	900-450/577/1-1	2.404	NA	Director/D	
B.4084	Central	SUB URBAN LUDHIANA	11kV	DS S/U DIVN. LALTON	KDS S/D NARANGWAL	D052FL04	Narangwal	AMR	OK	31.03.2023	AP 3Phase 3Wire				8223160	900-450/577/1-1	2.442	NA	Director/D	
B.4085	Central	SUB URBAN LUDHIANA	11kV	DS S/U DIVN. LALTON	KDS S/D NARANGWAL	D052FL17	MANJAWAL	AMR	OK	31.03.2023	AP 3Phase 3Wire				73200158	900-450/577/1-1	2.444	NA	Director/D	
B.4086	Central	SUB URBAN LUDHIANA	11kV	DS S/U DIVN. LALTON	KDS S/D NARANGWAL	D052FL19	DHAPAP	AMR	OK	31.03.2023	AP 3Phase 3Wire				9140945	900-450/577/1-1	2.597	NA	Director/D	
B.4087	Central	SUB URBAN LUDHIANA	11kV	DS S/U DIVN. LALTON	KDS S/D NARANGWAL	D052FL06	Chaminda	AMR	OK	31.03.2023	AP 3Phase 3Wire				8223158	900-450/577/1-1	2.673	NA	Director/D	
B.4088	Central	SUB URBAN LUDHIANA	11kV	DS S/U DIVN. LALTON	KDS S/D NARANGWAL	D052FL03	Phalewal	AMR	OK	31.03.2023	AP 3Phase 3Wire				8223156	900-450/577/1-1	2.763	NA	Director/D	
B.4089	Central	SUB URBAN LUDHIANA	11kV	DS S/U DIVN. LALTON	KDS S/D NARANGWAL	D052FL11	Link kalakah	AMR	OK	31.03.2023	AP 3Phase 3Wire				5280	900-450/577/1-1	2.796	NA	Director/D	
B.4090	Central	SUB URBAN LUDHIANA	11kV	DS S/U DIVN. LALTON	KDS S/D NARANGWAL	D052FL09	Jartauli	AMR	OK	31.03.2023	AP 3Phase 3Wire				2067287	900-450/577/1-1	2.933	NA	Director/D	
B.4091	Central	SUB URBAN LUDHIANA	11kV	DS S/U DIVN. LALTON	KDS S/D NARANGWAL	D052FL10	Kalana	AMR	OK	31.03.2023	AP 3Phase 3Wire				13479428	900-450/577/1-1	3.022	NA	Director/D	
B.4092	Central	SUB URBAN LUDHIANA	11kV	DS S/U DIVN. LALTON	KDS S/D NARANGWAL	D052FL12	SRABHA	AMR	OK	31.03.2023	AP 3Phase 3Wire				8421	900-450/577/1-1	3.136	NA	Director/D	
B.4093	Central	SUB URBAN LUDHIANA	11kV	DS S/U DIVN. LALTON	KDS S/D NARANGWAL	D052FL08	Lothgarh	AMR	OK	31.03.2023	AP 3Phase 3Wire				12479488	900-450/577/1-1	3.344	NA	Director/D	
B.4094	Central	SUB URBAN LUDHIANA	11kV	DS S/U DIVN. LALTON	KDS S/D NARANGWAL	D052FL02	Industry	NON AMR	OK	31.03.2023	Category 5 UPS				4262814	900-450/577/1-1	3.970	NA	Director/D	
B.4095	Central	SUB URBAN LUDHIANA	11kV	DS S/U DIVN. LALTON	KDS S/D NARANGWAL	D052FL13	MAURI	AMR	OK	31.03.2023	Category 5 UPS				34120	900-450/577/1-1	6.087	NA	Director/D	
B.4096	Central	SUB URBAN LUDHIANA	11kV	DS S/U DIVN. LALTON	KDS S/D NARANGWAL	D052FL23	SHAHPUR UPS	AMR	OK	31.03.2023	Category 5 UPS				73210599	900-450/577/1-1	6.631	NA	Director/D	
B.4097	Central	SUB URBAN LUDHIANA	11kV	DS S/U DIVN. LALTON	KDS S/D NARANGWAL	D052FL01	Jhan	AMR	OK	31.03.2023	Category 5 UPS				4262799	900-450/577/1-1	6.943	NA	Director/D	
B.4098	Central	SUB URBAN LUDHIANA	11kV	DS S/U DIVN. LALTON	KDS S/D NARANGWAL	D052FL14	SAVAN KALAN	NON AMR	OK	31.03.2023	Category 5 UPS				3637	900-450/577/1-1	10.386	NA	Director/D	
B.4099	Central	SUB URBAN LUDHIANA	11kV	DS S/U DIVN. LALTON	KDS S/D PAKHOWAL	D054FL08	Dhalian	AMR	OK	31.03.2023	AP 3Phase 3Wire				2066224	900-450/5	2.170	NA	Director/D	
B.4100	Central	SUB URBAN LUDHIANA	11kV	DS S/U DIVN. LALTON	KDS S/D PAKHOWAL	8054FL18	BARSOAN	AMR	OK	31.03.2023	AP 3Phase 3Wire				3168	1200-600/5	2.224	NA	Director/D	
B.4101	Central	SUB URBAN LUDHIANA	11kV	DS S/U DIVN. LALTON	KDS S/D PAKHOWAL	8054FL06	Leel	AMR	OK	31.03.2023	AP 3Phase 3Wire				2066612	900-450/577/1-1	2.354	NA	Director/D	
B.4102	Central	SUB URBAN LUDHIANA	11kV	DS S/U DIVN. LALTON	KDS S/D PAKHOWAL	8054FL14	Bronad (PKL)	AMR	OK	31.03.2023	AP 3Phase 3Wire				8223038	900-450/5	2.406	NA	Director/D	
B.4103	Central	SUB URBAN LUDHIANA	11kV	DS S/U DIVN. LALTON	KDS S/D PAKHOWAL	8054FL12	KALSIAN	AMR	OK	31.03.2023	AP 3Phase 3Wire				44959	900-450/577/1-1	2.502	NA	Director/D	
B.4104	Central	SUB URBAN LUDHIANA	11kV	DS S/U DIVN. LALTON	KDS S/D PAKHOWAL	8054FL15	RAIGARH	AMR	OK	31.03.2023	AP 3Phase 3Wire				3352	1200-600/5	2.504	NA	Director/D	
B.4105	Central	SUB URBAN LUDHIANA	11kV	DS S/U DIVN. LALTON	KDS S/D PAKHOWAL	8054FL04	Bhaini Darera	NON AMR	OK	31.03.2023	AP 3Phase 3Wire				3320	1200-600/5	2.518	NA	Director/D	
B.4106	Central	SUB URBAN LUDHIANA	11kV	DS S/U DIVN. LALTON	KDS S/D PAKHOWAL	8054FL16	Aandloo	AMR	OK	31.03.2023	AP 3Phase 3Wire			</						

S.No	Zone	Circle	Voltage Level (kVA)	Division (kVA)	Sub-Division (kVA)	Feeder ID	Feeder Name	Feeder Metering Status (Metered/unmetered/AMR/AMI)	Status of Meter (Functional/Non-functional)	Metering Date	Date of last actual meter reading/communication	Feeder Type (Agri./Industrial/Mixed)	Status of Communication			Period from 01.04.2021 to 31.03.2022				Sales	Remarks (Source of data)
													% data received through automatically if feeder AMR/AMI	Number of hours when meter was unable to communicate in overall	Total Number of hours in the period	Meter S.No	CT/Ratio	Import (kWh)	Export (kWh)		
B.4141	Central	SUB URBAN LUDHIANA	11KV	DS S/U DIVN. LALTON	DS S/D SARINH	D053FL07	Paper Mill	NON AMR	OK	31.03.2023		Category 5-UPS				2067077	1200/577/1-1-1	11,405	NA	Director/D	
B.4142	Central	SUB URBAN LUDHIANA	11KV	DS S/U DIVN. LALTON	DS S/D SARINH	D053FL10	Dehlon	NON AMR	OK	31.03.2023		Category 5-UPS				4180059	1200/577/1-1-1	13,152	NA	Director/D	
B.4143	Central	SUB URBAN LUDHIANA	11KV	DS S/U DIVN. LALTON	DS S/D SARINH	D053FL18	Rania	NON AMR	OK	31.03.2023		Category 5-UPS				7042933	900-450/577/1-1-1	13,477	NA	Director/D	
B.4144	Central	SUB URBAN LUDHIANA	11KV	DS S/U DIVN. LALTON	DS S/D SARINH	D053FL14	Bachchan Nagar	NON AMR	OK	31.03.2023		Category 1				2067341	900-450/577/1-1-1	16,153	NA	Director/D	
B.4145	Central	SUB URBAN LUDHIANA	11KV	DS S/U DIVN. LALTON	DS S/D SARINH	D053FL19	BULLARA ROAD	AMR	OK	31.03.2023		Category 1				1117052	900-450/577/1-1-1	18,089	NA	Director/D	
B.4146	Central	SUB URBAN LUDHIANA	11KV	DS S/U DIVN. LALTON	DS S/D SARINH	1130FL18	Padri	AMR	OK	31.03.2023		AP 3Phase 3Wire				1254789	400-200/5-5	1,489	NA	Director/D	
B.4147	Central	SUB URBAN LUDHIANA	11KV	DS S/U DIVN. LALTON	DS S/D SARINH	1130FL17	Shelarian Wala	AMR	OK	31.03.2023		Category 5-UPS				124579	400-200/5-5	2,776	NA	Director/D	
B.4148	North	HOSHARPUR	11KV	DS CITY DIVN. HSP	DS CITY S/D HSP	F7060731	KOTWALI BAZAR	AMR	OK	31.03.2023		Category 1				151956631	200-100/5-5	4,098	NA	Director/D	
B.4149	North	HOSHARPUR	11KV	DS CITY DIVN. HSP	DS CITY S/D HSP	F7060701	QUR MANDI	AMR	OK	31.03.2023		Category 1				151956631	200-100/5-5	6,563	NA	Director/D	
B.4150	North	HOSHARPUR	11KV	DS CITY DIVN. HSP	DS CITY S/D HSP	F705F005	COURT COMPLEX	AMR	OK	31.03.2023		Category 4				73101431	400-200/5-5	0,955	NA	Director/D	
B.4151	North	HOSHARPUR	11KV	DS CITY DIVN. HSP	DS CITY S/D HSP	F705F003	RED ROAD	AMR	OK	31.03.2023		Category 1				73101439	400-200/5-5	4,724	NA	Director/D	
B.4152	North	HOSHARPUR	11KV	DS CITY DIVN. HSP	DS CITY S/D HSP	D732FL09	11 KV Balrishan Road	AMR	OK	31.03.2023		Category 1				73185900	400-200/5-5	5,460	NA	Director/D	
B.4153	North	HOSHARPUR	11KV	DS CITY DIVN. HSP	DS CITY S/D HSP	F705FL01	GREEN VIEW PARK	AMR	OK	31.03.2023		Category 1				73194518	400-200/5-5	7,315	NA	Director/D	
B.4154	North	HOSHARPUR	11KV	DS CITY DIVN. HSP	DS CITY S/D HSP	F705FL02	LIC	AMR	OK	31.03.2023		Category 1				73185923	400-200/5-5	10,231	NA	Director/D	
B.4155	North	HOSHARPUR	11KV	DS CITY DIVN. HSP	DS CITY S/D HSP	D712FL08	Sulehri Road	AMR	OK	31.03.2023		Category 1				10283274	900-450/577/1-1-1	7,906	NA	Director/D	
B.4156	North	HOSHARPUR	11KV	DS CITY DIVN. HSP	DS CIVIL LINES S/D HSP	C703FL01	FATEGARH	AMR	OK	31.03.2023		Category 1				5295548	1200/577/1-1-1	9,768	NA	Director/D	
B.4157	North	HOSHARPUR	11KV	DS CITY DIVN. HSP	DS CIVIL LINES S/D HSP	D732FL10	D. C.ROAD	AMR	OK	31.03.2023		Category 1				4962	400-200/5-5	6,521	NA	Director/D	
B.4158	North	HOSHARPUR	11KV	DS CITY DIVN. HSP	DS CIVIL LINES S/D HSP	D712FL07	SHIVAM HOSPITAL	AMR	OK	31.03.2023		Category 1				12479544	900-450/577/1-1-1	1,213	NA	Director/D	
B.4159	North	HOSHARPUR	11KV	DS CITY DIVN. HSP	DS CIVIL LINES S/D HSP	D712FL06	SUNDER NAGAR	AMR	OK	31.03.2023		Category 1				7336940	900-450/577/1-1-1	7,928	NA	Director/D	
B.4160	North	HOSHARPUR	11KV	DS CITY DIVN. HSP	DS CIVIL LINES S/D HSP	D712FL04	MOUNT AVENUE	AMR	OK	31.03.2023		Category 1				6075557	900-450/577/1-1-1	9,323	NA	Director/D	
B.4161	North	HOSHARPUR	11KV	DS CITY DIVN. HSP	DS CIVIL LINES S/D HSP	D705FL13	11 KV Coca Cola	AMR	OK	31.03.2023		Category 5-UPS				12479372	900-450/577/1-1-1	0,000	NA	Director/D	
B.4162	North	HOSHARPUR	11KV	DS CITY DIVN. HSP	DS CIVIL LINES S/D HSP	D705FL10	SSC. UNIVERSITY	AMR	OK	31.03.2023		Category 4				3383	1200/577/1-1-1	0,475	NA	Director/D	
B.4163	North	HOSHARPUR	11KV	DS CITY DIVN. HSP	DS CIVIL LINES S/D HSP	D705FL09	PB. AGRO	AMR	OK	31.03.2023		Category 4				8223817	900-450/577/1-1-1	0,519	NA	Director/D	
B.4164	North	HOSHARPUR	11KV	DS CITY DIVN. HSP	DS CIVIL LINES S/D HSP	D705FL19	11 KV Jahankhan	AMR	OK	31.03.2023		Kandi Pure AP				9534371	1200/577/1-1-1	0,777	NA	Director/D	
B.4165	North	HOSHARPUR	11KV	DS CITY DIVN. HSP	DS CIVIL LINES S/D HSP	D705FL08	BAJWARA	AMR	OK	31.03.2023		Category 1				8223816	1200/577/1-1-1	4,057	NA	Director/D	
B.4166	North	HOSHARPUR	11KV	DS CITY DIVN. HSP	DS CIVIL LINES S/D HSP	D705FL14	KARWAR	AMR	OK	31.03.2023		Category 5-UPS				3842	1200/577/1-1-1	4,512	NA	Director/D	
B.4167	North	HOSHARPUR	11KV	DS CITY DIVN. HSP	DS CIVIL LINES S/D HSP	D705FL07	PRIC	AMR	OK	31.03.2023		Category 1				8223137	900-450/577/1-1-1	5,093	NA	Director/D	
B.4168	North	HOSHARPUR	11KV	DS CITY DIVN. HSP	DS CIVIL LINES S/D HSP	D705FL17	11 KV Narayan Nagar	AMR	OK	31.03.2023		Category 1				7042946	1200/577/1-1-1	5,932	NA	Director/D	
B.4169	North	HOSHARPUR	11KV	DS CITY DIVN. HSP	DS CIVIL LINES S/D HSP	D705FL12	Bassi Gulam Hussain	AMR	OK	31.03.2023		Kandi Mixed				12093576	900-450/577/1-1-1	6,783	NA	Director/D	
B.4170	North	HOSHARPUR	11KV	DS CITY DIVN. HSP	DS CIVIL LINES S/D HSP	D705FL06	SHIMLA PAHARI	AMR	OK	31.03.2023		Category 1				8223315	900-450/577/1-1-1	7,402	NA	Director/D	
B.4171	North	HOSHARPUR	11KV	DS CITY DIVN. HSP	DS CIVIL LINES S/D HSP	D705FL09	Service club	AMR	OK	31.03.2023		Category 1				12479421	1200/577/1-1-1	10,030	NA	Director/D	
B.4172	North	HOSHARPUR	11KV	DS CITY DIVN. HSP	DS CIVIL LINES S/D HSP	D705FL05	NARA DADA	AMR	OK	31.03.2023		Kandi Mixed				7336659	1200/577/1-1-1	10,803	NA	Director/D	
B.4173	North	HOSHARPUR	11KV	DS CITY DIVN. HSP	DS CIVIL LINES S/D HSP	D705FL03	CHAUHNI	AMR	OK	31.03.2023		Kandi Mixed				8223819	1200/577/1-1-1	12,755	NA	Director/D	
B.4174	North	HOSHARPUR	11KV	DS CITY DIVN. HSP	DS CIVIL LINES S/D HSP	D705FL02	ASLAMABAD	AMR	OK	31.03.2023		Category 1				8222428	900-450/577/1-1-1	14,061	NA	Director/D	
B.4175	North	HOSHARPUR	11KV	DS CITY DIVN. HSP	DS CIVIL LINES S/D HSP	D705FL04	JAHAN KHELAN	Not available	OK	31.03.2023		Kandi Mixed				Not available	Not available	2,783	NA	Director/D	
B.4176	North	HOSHARPUR	11KV	DS CITY DIVN. HSP	DS CIVIL LINES S/D HSP	D705FL18	11 KV Jahankhan	Not available	OK	31.03.2023		AP 3Phase 3Wire				Not available	Not available	5,822	NA	Director/D	
B.4177	North	HOSHARPUR	11KV	DS CITY DIVN. HSP	DS CIVIL LINES S/D HSP	C703FL05	MAHAJUR SPC MILL	NON AMR	OK	31.03.2023		Category 4				Not available	Not available	63,446	NA	Director/D	
B.4178	North	HOSHARPUR	11KV	DS CITY DIVN. HSP	DS MODEL TOWN S/D HSP	C703FL16	Incomeing Gowsbaha s/s	NON AMR	OK	31.03.2023		Category 1				5463628	1200/577/1-1-1	0,000	NA	Director/D	
B.4179	North	HOSHARPUR	11KV	DS CITY DIVN. HSP	DS MODEL TOWN S/D HSP	C703FL15	Civil Hospital	NON AMR	OK	31.03.2023		Category 4				6489152	600/577/1-1-1	1,224	NA	Director/D	
B.4180	North	HOSHARPUR	11KV	DS CITY DIVN. HSP	DS MODEL TOWN S/D HSP	C703FL09	Chetna Park	NON AMR	OK	31.03.2023		Kandi Mixed				4221161	600/577/1-1-1	2,062	NA	Director/D	
B.4181	North	HOSHARPUR	11KV	DS CITY DIVN. HSP	DS MODEL TOWN S/D HSP	C703FL06	Ghanta Ghar	NON AMR	OK	31.03.2023		Category 1				4187899	600/577/1-1-1	2,632	NA	Director/D	
B.4182	North	HOSHARPUR	11KV	DS CITY DIVN. HSP	DS MODEL TOWN S/D HSP	C703FL10	Model Town	NON AMR	OK	31.03.2023		Category 1				4221062	600/577/1-1-1	6,804	NA	Director/D	
B.4183	North	HOSHARPUR	11KV	DS CITY DIVN. HSP	DS MODEL TOWN S/D HSP	C703FL03	mini mandir	NON AMR	OK	31.03.2023		Category 1				4180042	1200/577/1-1-1	4,588	NA	Director/D	
B.4184	North	HOSHARPUR	11KV	DS CITY DIVN. HSP	DS MODEL TOWN S/D HSP	D711FTM2	ROSHANG GROUND	NON AMR	OK	31.03.2023		Category 1				44903	900-450/577/1-1-1	5,148	NA	Director/D	
B.4185	North	HOSHARPUR	11KV	DS CITY DIVN. HSP	DS MODEL TOWN S/D HSP	D711FTM1	RAM MANDIR	AMR	OK	31.03.2023		Category 1				15194743	900-450/577/1-1-1	5,977	NA	Director/D	
B.4186	North	HOSHARPUR	11KV	DS CITY DIVN. HSP	DS MODEL TOWN S/D HSP	C703FL13	Tagore Nagar	NON AMR	OK	31.03.2023		Category 1				44925	900-450/577/1-1-1	6,988	NA	Director/D	
B.4187	North	HOSHARPUR	11KV	DS CITY DIVN. HSP	DS MODEL TOWN S/D HSP	P0H9FR04	Lajwanti Stadium	AMR	OK	31.03.2023		Category 1				44902	900-450/577/1-1-1	7,996	NA	Director/D	
B.4188	North	HOSHARPUR	11KV	DS CITY DIVN. HSP	DS MODEL TOWN S/D HSP	D732FL03	Katpura	NON AMR	OK	31.03.2023		Category 1				151956631	200-100/5-5	5,076	NA	Director/D	
B.4189	North	HOSHARPUR	11KV	DS CITY DIVN. HSP	DS MODEL TOWN S/D HSP	D732FL04	Karwar	NON AMR	OK	31.03.2023		Category 1				151956631	200-100/5-5	6,094	NA	Director/D	
B.4190	North	HOSHARPUR	11KV	DS CITY DIVN. HSP	DS MODEL TOWN S/D HSP	C7E19	milk plant	NON AMR	OK	31.03.2023		Category 4				11117004	900-450/577/1-1-1	1,568	NA	Director/D	
B.4191	North	HOSHARPUR	11KV	DS CITY DIVN. HSP	DS MODEL TOWN S/D HSP	000new	Salwara	NON AMR	OK	31.03.2023		Category 1				10288300	900-450/577/1-1-1	7,789	NA	Director/D	
B.4192	North	HOSHARPUR	11KV	DS CITY DIVN. HSP	DS MODEL TOWN S/D HSP	000new	Barjarbag	AMR	OK	31.03.2023		Category 1				11051988	900-450/577/1-1-1	9,395	NA	Director/D	
B.4193	North	HOSHARPUR	11KV	DS CITY DIVN. HSP	DS S/D Janauri	D7H2FL08	11 KV Bassi Wazid	AMR	OK	31.03.2023		Kandi Pure AP				73132918	400-200/5-5	0,310	NA	Director/D	
B.4194	North	HOSHARPUR	11KV	DS CITY DIVN. HSP	DS S/D Janauri	D7H2FL07	11 KV Bassi Wazid	AMR	OK	31.03.2023		AP 3Phase 3Wire				73132918	400-200/5-5	4,067	NA	Director/D	
B.4195	North	HOSHARPUR	11KV	DS CITY DIVN. HSP	DS S/D Janauri	D7H2FL06	Lahur	AMR	OK	31.03.2023		Category 5-UPS				3848	400-200/5-5	2,368	NA	Director/D	
B.4196	North	HOSHARPUR	11KV	DS CITY DIVN. HSP	DS S/D Janauri	D7H2FL01	Janauri-2	AMR	OK	31.03.2023		Kandi Mixed				73132918	400-200/5-5	3,113	NA	Director/D	
B.4197	North	HOSHARPUR	11KV	DS CITY DIVN. HSP	DS S/D Janauri	D7H2FL05	11KV BHATOLIAN	AMR	OK	31.03.2023		Kandi Mixed									

S.No	Zone	Circle	Voltage Level (kVA)	Division (kVA)	Sub-Division (kVA)	Feeder ID	Feeder Name	Feeder Metering Status (Metered/unmetered/AMR/AM)	Status of Meter (Functional/Non-functional)	Metering Date	Date of last actual meter reading/communication	Feeder Type (Agr/Industrial/Mixed)	Status of Communication			Period from 01.04.2021 to 31.03.2022				Sales	Remarks (Source of data)
													% data received through automatically if feeder AMR/AM	Number of hours when meter was unable to communicate in period	Total Number of hours in the period	Meter S.No	CT/PT ratio	Import (kWh)	Export (kWh)		
B.4238	North	HOSHARPUR	11kV	DS DIVN. BHOGPUR	DS S/D CITY TANDA	C704FL15	SALLAN	AMR	OK	31.03.2023		Category 5-UPS	0	0	0	5137	900-450/577/1-1-1	8.752	NA	Director/D	
B.4239	North	HOSHARPUR	11kV	DS DIVN. BHOGPUR	DS S/D CITY TANDA	C704FL23	URMAR	AMR	OK	31.03.2023		Category 1	10283008	1200/577/1-1-1	8.883	NA	Director/D	NA	Director/D		
B.4240	North	HOSHARPUR	11kV	DS DIVN. BHOGPUR	DS S/D CITY TANDA	C704FL03	Tanda City	AMR	OK	31.03.2023		Category 1	2068258	1200/577/1-1-1	13.600	NA	Director/D	NA	Director/D		
B.4241	North	HOSHARPUR	11kV	DS DIVN. BHOGPUR	DS S/D CITY-1 BHOGPUR	C701FL20	MUMAMNDPUR	AMR	OK	31.03.2023		AP 3Phase 3Wire	12479732	1200/577/1-1-1	1.281	NA	Director/D	NA	Director/D		
B.4242	North	HOSHARPUR	11kV	DS DIVN. BHOGPUR	DS S/D CITY-1 BHOGPUR	C701FL10	GHUG	AMR	OK	31.03.2023		AP 3Phase 3Wire	8222576	1200/577/1-1-1	2.603	NA	Director/D	NA	Director/D		
B.4243	North	HOSHARPUR	11kV	DS DIVN. BHOGPUR	DS S/D CITY-1 BHOGPUR	C701FL06	PEPSI	AMR	OK	31.03.2023		AP 3Phase 3Wire	12479661	900-450/577/1-1-1	2.605	NA	Director/D	NA	Director/D		
B.4244	North	HOSHARPUR	11kV	DS DIVN. BHOGPUR	DS S/D CITY-1 BHOGPUR	C701FL01	BUTRAN	AMR	OK	31.03.2023		AP 3Phase 3Wire	8222574	900-450/577/1-1-1	2.741	NA	Director/D	NA	Director/D		
B.4245	North	HOSHARPUR	11kV	DS DIVN. BHOGPUR	DS S/D CITY-1 BHOGPUR	C701FL04	PACHARANGA	NON AMR	OK	31.03.2023		AP 3Phase 3Wire	12479785	900-450/577/1-1-1	2.942	NA	Director/D	NA	Director/D		
B.4246	North	HOSHARPUR	11kV	DS DIVN. BHOGPUR	DS S/D CITY-1 BHOGPUR	C701FL19	BHOGPUR NO 2	AMR	OK	31.03.2023		Category 1	52065715	900-450/577/1-1-1	5.922	NA	Director/D	NA	Director/D		
B.4247	North	HOSHARPUR	11kV	DS DIVN. BHOGPUR	DS S/D CITY-1 BHOGPUR	C701FL09	Suger mill	NON AMR	OK	31.03.2023		Category 2	12479748	1200/577/1-1-1	6.094	NA	Director/D	NA	Director/D		
B.4248	North	HOSHARPUR	11kV	DS DIVN. BHOGPUR	DS S/D CITY-1 BHOGPUR	C701FL03	Bhogpur	AMR	OK	31.03.2023		Category 1	5295570	1200/577/1-1-1	10.015	NA	Director/D	NA	Director/D		
B.4249	North	HOSHARPUR	11kV	DS DIVN. BHOGPUR	DS S/D CITY-1 BHOGPUR	C701FL12	DALLI shared feeder with s/divn	AMR	OK	31.03.2023		Category 5-UPS	12479471	1200/577/1-1-1	11.676	NA	Director/D	NA	Director/D		
B.4250	North	HOSHARPUR	11kV	DS DIVN. BHOGPUR	DS S/D CITY-1 BHOGPUR	D0628FL14	Bullowal Branch	AMR	OK	31.03.2023		AP 3Phase 3Wire	11117213	900-450/577/1-1-1	1.299	NA	Director/D	NA	Director/D		
B.4251	North	HOSHARPUR	11kV	DS DIVN. BHOGPUR	DS S/D CITY-1 BHOGPUR	T001FL01	GHUG	AMR	OK	31.03.2023		Category 1	23205	900-450/577/1-1-1	0.376	NA	Director/D	NA	Director/D		
B.4252	North	HOSHARPUR	11kV	DS DIVN. BHOGPUR	DS S/D CITY-1 BHOGPUR	T001FL04	Bhogpur	AMR	OK	31.03.2023		AP 3Phase 3Wire	23585	900-450/577/1-1-1	1.445	NA	Director/D	NA	Director/D		
B.4253	North	HOSHARPUR	11kV	DS DIVN. BHOGPUR	DS S/D CITY-1 BHOGPUR	T001FL03	BULLEY	AMR	OK	31.03.2023		AP 3Phase 3Wire	23206	900-450/577/1-1-1	1.656	NA	Director/D	NA	Director/D		
B.4254	North	HOSHARPUR	11kV	DS DIVN. BHOGPUR	DS S/D CITY-1 BHOGPUR	T001FL02	11KV BULLOWAL	AMR	OK	31.03.2023		AP 3Phase 3Wire	23209	900-450/577/1-1-1	1.772	NA	Director/D	NA	Director/D		
B.4255	North	HOSHARPUR	11kV	DS DIVN. BHOGPUR	DS S/D CITY-1 BHOGPUR	T0010000	11 KV Kurala 2	AMR	OK	31.03.2023		AP 3Phase 3Wire	4675	900-450/577/1-1-1	2.111	NA	Director/D	NA	Director/D		
B.4256	North	HOSHARPUR	11kV	DS DIVN. BHOGPUR	DS S/D CITY-1 BHOGPUR	T001FL06	BULLOWAL NO 2	NON AMR	OK	31.03.2023		Category 5-UPS	37699	900-450/577/1-1-1	2.979	NA	Director/D	NA	Director/D		
B.4257	North	HOSHARPUR	11kV	DS DIVN. BHOGPUR	DS S/D CITY-1 BHOGPUR	T001FL05	11KV SATOWALI	AMR	OK	31.03.2023		Category 5-UPS	0	900-450/577/1-1-1	4.572	NA	Director/D	NA	Director/D		
B.4258	North	HOSHARPUR	11kV	DS DIVN. BHOGPUR	DS S/D CITY-1 BHOGPUR	D062SFL01	CHAKRALA	AMR	OK	31.03.2023		AP 3Phase 3Wire	10777238	600/577/1-1-1	1.449	NA	Director/D	NA	Director/D		
B.4259	North	HOSHARPUR	11kV	DS DIVN. BHOGPUR	DS S/D CITY-1 BHOGPUR	D062S01	11 KV TALWADI BHEELAN	AMR	OK	31.03.2023		AP 3Phase 3Wire	1	600/577/1-1-1	1.933	NA	Director/D	NA	Director/D		
B.4260	North	HOSHARPUR	11kV	DS DIVN. BHOGPUR	DS S/D CITY-1 BHOGPUR	D062SFL09	AMAAKZI	AMR	OK	31.03.2023		AP 3Phase 3Wire	10098947	600/577/1-1-1	2.573	NA	Director/D	NA	Director/D		
B.4261	North	HOSHARPUR	11kV	DS DIVN. BHOGPUR	DS S/D CITY-1 BHOGPUR	D062SFL04	KHANKEJ	AMR	OK	31.03.2023		AP 3Phase 3Wire	8223860	600/577/1-1-1	2.822	NA	Director/D	NA	Director/D		
B.4262	North	HOSHARPUR	11kV	DS DIVN. BHOGPUR	DS S/D CITY-1 BHOGPUR	E701FL11	I J INTERNATIONAL	AMR	OK	31.03.2023		Category 3	2065811	600/577/1-1-1	0.240	NA	Director/D	NA	Director/D		
B.4263	North	HOSHARPUR	11kV	DS DIVN. BHOGPUR	DS S/D CITY-1 BHOGPUR	E701FL08	NIJAM DEENPUR	AMR	OK	31.03.2023		Category 5-UPS	8223290	600/577/1-1-1	1.762	NA	Director/D	NA	Director/D		
B.4264	North	HOSHARPUR	11kV	DS DIVN. BHOGPUR	DS S/D CITY-1 BHOGPUR	E701FL05	Kurala	AMR	OK	31.03.2023		AP 3Phase 3Wire	8223494	600/577/1-1-1	2.201	NA	Director/D	NA	Director/D		
B.4265	North	HOSHARPUR	11kV	DS DIVN. BHOGPUR	DS S/D CITY-1 BHOGPUR	E701FL19	Jatlabad	AMR	OK	31.03.2023		AP 3Phase 3Wire	8222591	900-450/577/1-1-1	2.278	NA	Director/D	NA	Director/D		
B.4266	North	HOSHARPUR	11kV	DS DIVN. BHOGPUR	DS S/D CITY-1 BHOGPUR	E701FL12	kandhalu guru	AMR	OK	31.03.2023		AP 3Phase 3Wire	8223495	600/577/1-1-1	2.280	NA	Director/D	NA	Director/D		
B.4267	North	HOSHARPUR	11kV	DS DIVN. BHOGPUR	DS S/D CITY-1 BHOGPUR	E723FL09	TALWANDI	AMR	OK	31.03.2023		AP 3Phase 3Wire	73185023	600/577/1-1-1	2.724	NA	Director/D	NA	Director/D		
B.4268	North	HOSHARPUR	11kV	DS DIVN. BHOGPUR	DS S/D CITY-1 BHOGPUR	E703FL07	KSHANPUR	NON AMR	OK	31.03.2023		AP 3Phase 3Wire	8223492	900-450/577/1-1-1	3.001	NA	Director/D	NA	Director/D		
B.4269	North	HOSHARPUR	11kV	DS DIVN. BHOGPUR	DS S/D CITY-1 BHOGPUR	E713FL01	SUDHANA	AMR	OK	31.03.2023		Category 5-UPS	9154090	900-450/577/1-1-1	3.105	NA	Director/D	NA	Director/D		
B.4270	North	HOSHARPUR	11kV	DS DIVN. BHOGPUR	DS S/D CITY-1 BHOGPUR	E701FL04	KINGRA	NON AMR	OK	31.03.2023		Category 5-UPS	8223493	600/577/1-1-1	3.150	NA	Director/D	NA	Director/D		
B.4271	North	HOSHARPUR	11kV	DS DIVN. BHOGPUR	DS S/D CITY-1 BHOGPUR	E701FL01	KALA BAKRA shared feeder	Not available	OK	31.03.2023		Category 5-UPS	2068904	600/577/1-1-1	5.918	NA	Director/D	NA	Director/D		
B.4272	North	HOSHARPUR	66kV	DS DIVN. BHOGPUR	DS S/D CITY-1 BHOGPUR	DTH400	I.J. International	AMR	OK	31.03.2023		Category 3	Not available	Not available	31.472	NA	Director/D	NA	Director/D		
B.4273	North	HOSHARPUR	11kV	DS DIVN. BHOGPUR	DS S/D CITY-2 BHOGPUR	C701FL11	RAJPUJ	AMR	OK	31.03.2023		AP 3Phase 3Wire	12479505	900-450/577/1-1-1	3.326	NA	Director/D	NA	Director/D		
B.4274	North	HOSHARPUR	11kV	DS DIVN. BHOGPUR	DS S/D CITY-2 BHOGPUR	C701FL07	KALUWAHAR	AMR	OK	31.03.2023		AP 3Phase 3Wire	8222595	1200/577/1-1-1	3.478	NA	Director/D	NA	Director/D		
B.4275	North	HOSHARPUR	11kV	DS DIVN. BHOGPUR	DS S/D CITY-2 BHOGPUR	C701FL16	KURESHIAN	AMR	OK	31.03.2023		AP 3Phase 3Wire	0	1200/577/1-1-1	3.755	NA	Director/D	NA	Director/D		
B.4276	North	HOSHARPUR	11kV	DS DIVN. BHOGPUR	DS S/D CITY-2 BHOGPUR	C701FL13	nagal	NON AMR	OK	31.03.2023		AP 3Phase 3Wire	8222571	900-450/577/1-1-1	4.333	NA	Director/D	NA	Director/D		
B.4277	North	HOSHARPUR	11kV	DS DIVN. BHOGPUR	DS S/D CITY-2 BHOGPUR	C701FL02	KHARLA	AMR	OK	31.03.2023		AP 3Phase 3Wire	8222573	1200/577/1-1-1	4.431	NA	Director/D	NA	Director/D		
B.4278	North	HOSHARPUR	11kV	DS DIVN. BHOGPUR	DS S/D CITY-2 BHOGPUR	C701FL15	LAROYA	NON AMR	OK	31.03.2023		Category 5-UPS	12479586	1200/577/1-1-1	5.604	NA	Director/D	NA	Director/D		
B.4279	North	HOSHARPUR	11kV	DS DIVN. BHOGPUR	DS S/D CITY-2 BHOGPUR	C701FL08	KHARDEHER	NON AMR	OK	31.03.2023		Category 5-UPS	5295566	1200/577/1-1-1	10.182	NA	Director/D	NA	Director/D		
B.4280	North	HOSHARPUR	11kV	DS DIVN. BHOGPUR	DS S/D CITY-2 BHOGPUR	C701FL04	SARLA	NON AMR	OK	31.03.2023		Category 1	0	900-450/577/1-1-1	3.778	NA	Director/D	NA	Director/D		
B.4281	North	HOSHARPUR	11kV	DS DIVN. BHOGPUR	DS S/D CITY-2 BHOGPUR	DTH4FL03	NAUKA	AMR	OK	31.03.2023		AP 3Phase 3Wire	0	900-450/577/1-1-1	1.734	NA	Director/D	NA	Director/D		
B.4282	North	HOSHARPUR	11kV	DS DIVN. BHOGPUR	DS S/D CITY-2 BHOGPUR	DTH4FL6	Mali nagal	AMR	OK	31.03.2023		AP 3Phase 3Wire	5420	900-450/577/1-1-1	1.803	NA	Director/D	NA	Director/D		
B.4283	North	HOSHARPUR	11kV	DS DIVN. BHOGPUR	DS S/D CITY-2 BHOGPUR	DTH4FL02	Nangal Feedan	NON AMR	OK	31.03.2023		AP 3Phase 3Wire	36871	900-450/577/1-1-1	2.057	NA	Director/D	NA	Director/D		
B.4284	North	HOSHARPUR	11kV	DS DIVN. BHOGPUR	DS S/D CITY-2 BHOGPUR	DTH4FL05	LOHARAN	AMR	OK	31.03.2023		AP 3Phase 3Wire	0	900-450/577/1-1-1	3.480	NA	Director/D	NA	Director/D		
B.4285	North	HOSHARPUR	11kV	DS DIVN. BHOGPUR	DS S/D CITY-2 BHOGPUR	DTH4FL09	Bhogpur	AMR	OK	31.03.2023		Category 5-UPS	0	900-450/577/1-1-1	6.028	NA	Director/D	NA	Director/D		
B.4286	North	HOSHARPUR	11kV	DS DIVN. BHOGPUR	DS S/D CITY-2 BHOGPUR	E703FL08	KASBA	AMR	OK	31.03.2023		AP 3Phase 3Wire	5343293	900-450/577/1-1-1	4.434	NA	Director/D	NA	Director/D		
B.4287	North	HOSHARPUR	11kV	DS DIVN. BHOGPUR	DS S/D CITY-2 BHOGPUR	E703FL02	Nandachaur	NON AMR	OK	31.03.2023		AP 3Phase 3Wire	7042887	900-450/577/1-1-1	2.993	NA	Director/D	NA	Director/D		
B.4288	North	HOSHARPUR	11kV	DS DIVN. BHOGPUR	DS S/D CITY-2 BHOGPUR	E703FL05	PAJODEUTA	AMR	OK	31.03.2023		Category 5-UPS	2068229	900-450/577/1-1-1	6.318	NA	Director/D	NA	Director/D		
B.4289	North	HOSHARPUR	11kV	DS DIVN. BHOGPUR	DS S/D CITY-2 BHOGPUR	E701FL03	Manakari	AMR	OK	31.03.2023		AP 3Phase 3Wire	8223495	600/577/1-1-1	1.496	NA	Director/D	NA	Director/D		
B.4290	North	HOSHARPUR	11kV	DS DIVN. BHOGPUR	DS S/D CITY-2 BHOGPUR	EFL01	Soosa	AMR	OK	31.03.2023		Category 1	12479688	900-450/577/1-1-1	1.529	NA	Director/D	NA	Director/D		
B.4291	North	HOSHARPUR	11kV	DS DIVN. BHOGPUR	DS S/D CITY-2 BHOGPUR	E713FL04	Mandpur	AMR	OK	31.03.2023		AP 3Phase 3Wire	0	900-450/577/1-1-1	3.778	NA	Director/D	NA	Director/D		
B.4292	North	HOSHARPUR	11kV	DS DIVN. BHOGPUR	DS S/D CITY-2 BHOGPUR	D0727P09	BEHRAM	AMR	OK	31.03.2023		AP 3Phase 3Wire	23362	900-450/577/1-1-1	1.965	NA	Director/D	NA	Director/D		
B.4293	North																				

S.No	Zone	Circle	Voltage Level (kVA)	Division (kVA)	Sub-Division (kVA)	Feeder ID	Feeder Name	Feeder Metering Status (Metered/unmetered/AMR/AMI)	Status of Meter (Functional/Non-functional)	Metering Date (Date of last actual meter reading/communication)	Feeder Type (Agri/Industrial/Mixed)	Status of Communication			Period from 01.04.2021 to 31.03.2022				Sales	Remarks (Source of data)
												% data received through automatically by feeder AMR/AMI	Number of hours when meter was unable to communicate in overall	Total Number of hours in the period	Meter S.No	CT/PT ratio	Import (kWh)	Export (kWh)		
B.4335	North	HOSHARPUR	11KV	DS DIVN. DASUYA	DS S/D CITY DASUYA	D701FL18	11 KV ARMY GROUND	NON AMR	OK	31.03.2023	Category 1				4894	900-450/577/1-1-1	8.525	NA	Director/D	
B.4336	North	HOSHARPUR	11KV	DS DIVN. DASUYA	DS S/D CITY DASUYA	D701FL13	KALYANPUR	NON AMR	OK	31.03.2023	Category 5-UPS				4187994	900-450/577/1-1-1	11.271	NA	Director/D	
B.4337	North	HOSHARPUR	11KV	DS DIVN. DASUYA	DS S/D CITY DASUYA	D701FL11	DASUYA	AMR	OK	31.03.2023	Category 1				0	900-450/577/1-1-1	18.578	NA	Director/D	
B.4338	North	HOSHARPUR	11KV	DS DIVN. DASUYA	DS S/D GARDIHWAL	D702FL02	DHUGGA	AMR	OK	31.03.2023	AP 3Phase 3Wire				9140867	900-450/577/1-1-1	2.066	NA	Director/D	
B.4339	North	HOSHARPUR	11KV	DS DIVN. DASUYA	DS S/D GARDIHWAL	D702FL11	TALWANDI	AMR	OK	31.03.2023	AP 3Phase 3Wire				3	900-450/577/1-1-1	2.579	NA	Director/D	
B.4340	North	HOSHARPUR	11KV	DS DIVN. DASUYA	DS S/D GARDIHWAL	D702FL09	BAGHA	AMR	OK	31.03.2023	AP 3Phase 3Wire				9140868	900-450/577/1-1-1	3.185	NA	Director/D	
B.4341	North	HOSHARPUR	11KV	DS DIVN. DASUYA	DS S/D GARDIHWAL	D702FL06	RUPDWAL	AMR	OK	31.03.2023	AP 3Phase 3Wire				12479801	900-450/577/1-1-1	3.549	NA	Director/D	
B.4342	North	HOSHARPUR	11KV	DS DIVN. DASUYA	DS S/D GARDIHWAL	D702FL13	Khalisa College Gardhwal	AMR	OK	31.03.2023	Category 1				3844	900-450/577/1-1-1	4.359	NA	Director/D	
B.4343	North	HOSHARPUR	11KV	DS DIVN. DASUYA	DS S/D GARDIHWAL	FL15D702	AROWAL	AMR	OK	31.03.2023	Category 1				9411029	900-450/577/1-1-1	4.726	NA	Director/D	
B.4344	North	HOSHARPUR	11KV	DS DIVN. DASUYA	DS S/D GARDIHWAL	D702FL06	CHACK NUR ALI	AMR	OK	31.03.2023	Category 5-UPS				3943	900-450/577/1-1-1	5.547	NA	Director/D	
B.4345	North	HOSHARPUR	11KV	DS DIVN. DASUYA	DS S/D GARDIHWAL	D702FL04	GARDIHWAL	NON AMR	OK	31.03.2023	Category 1				7035626	900-450/577/1-1-1	7.316	NA	Director/D	
B.4346	North	HOSHARPUR	11KV	DS DIVN. DASUYA	DS S/D GARDIHWAL	D702FL1D	Pandori Attwal	AMR	OK	31.03.2023	Kandi Mixed				23601	900-450/577/1-1-1	9.456	NA	Director/D	
B.4347	North	HOSHARPUR	11KV	DS DIVN. DASUYA	DS S/D GARDIHWAL	D702FL07	CHAK KHELA	AMR	OK	31.03.2023	Category 5-UPS				6489728	900-450/577/1-1-1	9.825	NA	Director/D	
B.4348	North	HOSHARPUR	11KV	DS DIVN. DASUYA	DS S/D GARDIHWAL	D702FL12	MAKOWAL	AMR	OK	31.03.2023	Kandi Mixed				3301	900-450/577/1-1-1	9.836	NA	Director/D	
B.4349	North	HOSHARPUR	11KV	DS DIVN. DASUYA	DS S/D GARDIHWAL	D702FL05	MASTWAL	NON AMR	OK	31.03.2023	Kandi Mixed				9679967	900-450/577/1-1-1	12.072	NA	Director/D	
B.4350	North	HOSHARPUR	11KV	DS DIVN. DASUYA	DS S/D GARDIHWAL	D710FL03	DAWAKHRI	NON AMR	OK	31.03.2023	AP 3Phase 3Wire				8222799	900-450/577/1-1-1	2.427	NA	Director/D	
B.4351	North	HOSHARPUR	11KV	DS DIVN. DASUYA	DS S/D GARDIHWAL	D710FL04	DHUGGA	NON AMR	OK	31.03.2023	AP 3Phase 3Wire				8222798	900-450/577/1-1-1	2.522	NA	Director/D	
B.4352	North	HOSHARPUR	11KV	DS DIVN. DASUYA	DS S/D GARDIHWAL	D710FL07	KHANPUR	Not available	OK	31.03.2023	Category 5-UPS				5342487	900-450/577/1-1-1	5.760	NA	Director/D	
B.4353	North	HOSHARPUR	11KV	DS DIVN. DASUYA	DS S/D GARDIHWAL	D702FL03	DHOOT KALAN	Not available	OK	31.03.2023	Kandi Mixed				Not available	Not available	5.036	NA	Director/D	
B.4354	North	HOSHARPUR	11KV	DS DIVN. DASUYA	DS S/D GARDIHWAL	D702FL01	SANSARPUR	Not available	OK	31.03.2023	Not available				Not available	Not available	5.962	NA	Director/D	
B.4355	North	HOSHARPUR	11KV	DS DIVN. DASUYA	DS S/D GARDIHWAL	D702FL08	MANGARH	NON AMR	OK	31.03.2023	Kandi Mixed				Not available	Not available	6.736	NA	Director/D	
B.4356	North	HOSHARPUR	11KV	DS DIVN. DASUYA	DS S/D GHOGHRA	NEW1FL02	SAGRA	NON AMR	OK	31.03.2023	Kandi Mixed				9155356	900-450/577/1-1-1	2.796	NA	Director/D	
B.4357	North	HOSHARPUR	11KV	DS DIVN. DASUYA	DS S/D GHOGHRA	NEW1FL01	GHOGRA	NON AMR	OK	31.03.2023	Kandi Mixed				9154105	900-450/577/1-1-1	6.753	NA	Director/D	
B.4358	North	HOSHARPUR	11KV	DS DIVN. DASUYA	DS S/D GHOGHRA	NEW1FL04	CHANNIYA	NON AMR	OK	31.03.2023	Kandi Mixed				9154106	900-450/577/1-1-1	6.849	NA	Director/D	
B.4359	North	HOSHARPUR	11KV	DS DIVN. DASUYA	DS S/D GHOGHRA	NEW1FL03	RANDORI	NON AMR	OK	31.03.2023	Kandi Mixed				9154017	900-450/577/1-1-1	8.940	NA	Director/D	
B.4360	North	HOSHARPUR	11KV	DS DIVN. DASUYA	DS S/D GHOGHRA	NEW1FL05	BAOLA	AMR	OK	31.03.2023	Kandi Mixed				9154141	900-450/577/1-1-1	9.007	NA	Director/D	
B.4361	North	HOSHARPUR	11KV	DS DIVN. DASUYA	DS S/D MAINI	D703FL02	RARA	AMR	OK	31.03.2023	AP 3Phase 3Wire				8223810	900-450/577/1-1-1	2.006	NA	Director/D	
B.4362	North	HOSHARPUR	11KV	DS DIVN. DASUYA	DS S/D MAINI	D703FL05	ALAMPUR	AMR	OK	31.03.2023	AP 3Phase 3Wire				8223809	900-450/577/1-1-1	2.259	NA	Director/D	
B.4363	North	HOSHARPUR	11KV	DS DIVN. DASUYA	DS S/D MAINI	D703FL01	NATHPUR	AMR	OK	31.03.2023	AP 3Phase 3Wire				8223808	900-450/577/1-1-1	2.537	NA	Director/D	
B.4364	North	HOSHARPUR	11KV	DS DIVN. DASUYA	DS S/D MAINI	D703FL03	JALALPUR	NON AMR	OK	31.03.2023	AP 3Phase 3Wire				8223807	900-450/577/1-1-1	2.548	NA	Director/D	
B.4365	North	HOSHARPUR	11KV	DS DIVN. DASUYA	DS S/D MAINI	D703FL04	GIZIAN	AMR	OK	31.03.2023	AP 3Phase 3Wire				2068992	900-450/577/1-1-1	2.676	NA	Director/D	
B.4366	North	HOSHARPUR	11KV	DS DIVN. DASUYA	DS S/D MAINI	D703FL06	MIANI	AMR	OK	31.03.2023	Category 5-UPS				8223726	900-450/577/1-1-1	6.553	NA	Director/D	
B.4367	North	HOSHARPUR	11KV	DS DIVN. DASUYA	DS S/D MAINI	D703FL08	BAINSAN	AMR	OK	31.03.2023	Category 5-UPS				2068600	900-450/577/1-1-1	6.604	NA	Director/D	
B.4368	North	HOSHARPUR	11KV	DS DIVN. DASUYA	DS S/D MAINI	D703FL09	Salempur	AMR	OK	31.03.2023	Category 5-UPS				6761943	900-450/577/1-1-1	8.401	NA	Director/D	
B.4369	North	HOSHARPUR	11KV	DS DIVN. DASUYA	DS S/D MAINI	D703FL07	KOTLA	AMR	OK	31.03.2023	Category 5-UPS				2068508	900-450/577/1-1-1	9.618	NA	Director/D	
B.4370	North	HOSHARPUR	11KV	DS DIVN. DASUYA	DS S/U S/D DASUYA	D701FL17	11 KV Banial Feeder	NON AMR	OK	31.03.2023	Category 5-UPS				3840	900-450/577/1-1-1	5.019	NA	Director/D	
B.4371	North	HOSHARPUR	11KV	DS DIVN. DASUYA	DS S/U S/D DASUYA	D701FL14	MAND PHANDER	AMR	OK	31.03.2023	Kandi Mixed				9140472	900-450/577/1-1-1	6.401	NA	Director/D	
B.4372	North	HOSHARPUR	11KV	DS DIVN. DASUYA	DS S/U S/D DASUYA	D701FL16	11KV MALLDIAL FEEDER	AMR	OK	31.03.2023	Category 5-UPS				3839	900-450/577/1-1-1	6.817	NA	Director/D	
B.4373	North	HOSHARPUR	11KV	DS DIVN. DASUYA	DS S/U S/D DASUYA	D701FL08	PANWAN	AMR	OK	31.03.2023	Kandi Mixed				12479375	900-450/577/1-1-1	8.122	NA	Director/D	
B.4374	North	HOSHARPUR	11KV	DS DIVN. DASUYA	DS S/U S/D DASUYA	D710FL01	RAIHAN	AMR	OK	31.03.2023	AP 3Phase 3Wire				8222800	900-450/577/1-1-1	2.082	NA	Director/D	
B.4375	North	HOSHARPUR	11KV	DS DIVN. DASUYA	DS S/U S/D DASUYA	D710FL02	BODAL	NON AMR	OK	31.03.2023	AP 3Phase 3Wire				8222796	900-450/577/1-1-1	2.853	NA	Director/D	
B.4376	North	HOSHARPUR	11KV	DS DIVN. DASUYA	DS S/U S/D DASUYA	D710FL09	AROWAL	Not available	OK	31.03.2023	Category 5-UPS				6761916	900-450/577/1-1-1	11.039	NA	Director/D	
B.4377	North	HOSHARPUR	11KV	DS DIVN. DASUYA	DS S/U S/D DASUYA	D701FL05	SHANPUR	Not available	OK	31.03.2023	Category 5-UPS				Not available	Not available	1.795	NA	Director/D	
B.4378	North	HOSHARPUR	11KV	DS DIVN. DASUYA	DS S/U S/D DASUYA	D701FL09	PASSI KANDI	Not available	OK	31.03.2023	Kandi Mixed				Not available	Not available	5.271	NA	Director/D	
B.4379	North	HOSHARPUR	11KV	DS DIVN. DASUYA	DS S/U S/D DASUYA	D701FL12	MIRPUR	AMR	OK	31.03.2023	Kandi Mixed				Not available	Not available	6.740	NA	Director/D	
B.4380	North	HOSHARPUR	11KV	DS DIVN. MAHILPUR	DS S/D BASSI KALAN	E709FL01	Harta	AMR	OK	31.03.2023	AP 3Phase 3Wire				12479387	900-450/577/1-1-1	4.657	NA	Director/D	
B.4381	North	HOSHARPUR	11KV	DS DIVN. MAHILPUR	DS S/D BASSI KALAN	E709FL05	Jallowal	NON AMR	OK	31.03.2023	Category 5-UPS				2068788	900-450/577/1-1-1	5.098	NA	Director/D	
B.4382	North	HOSHARPUR	11KV	DS DIVN. MAHILPUR	DS S/D BASSI KALAN	D715FL02	WADHWA	NON AMR	OK	31.03.2023	AP 3Phase 3Wire				10281204	900-450/577/1-1-1	3.566	NA	Director/D	
B.4383	North	HOSHARPUR	11KV	DS DIVN. MAHILPUR	DS S/D BASSI KALAN	D715FL03	PATTI ND-2	AMR	OK	31.03.2023	Kandi Mixed				10281305	900-450/577/1-1-1	5.567	NA	Director/D	
B.4384	North	HOSHARPUR	11KV	DS DIVN. MAHILPUR	DS S/D BASSI KALAN	D715FL22	JHUNDIGAN	AMR	OK	31.03.2023	Kandi Pure AP				37699	900-450/577/1-1-1	2.269	NA	Director/D	
B.4385	North	HOSHARPUR	11KV	DS DIVN. MAHILPUR	DS S/D BASSI KALAN	D715FL21	JANDOLI	AMR	OK	31.03.2023	Kandi Pure AP				37699	900-450/577/1-1-1	3.669	NA	Director/D	
B.4386	North	HOSHARPUR	11KV	DS DIVN. MAHILPUR	DS S/D BASSI KALAN	D715FL16	Sarangwal	AMR	OK	31.03.2023	Category 5-UPS				3851	900-450/577/1-1-1	3.804	NA	Director/D	
B.4387	North	HOSHARPUR	11KV	DS DIVN. MAHILPUR	DS S/D BASSI KALAN	D715FL15	BALASAR	AMR	OK	31.03.2023	Category 5-UPS				7194104	900-450/577/1-1-1	3.897	NA	Director/D	
B.4388	North	HOSHARPUR	11KV	DS DIVN. MAHILPUR	DS S/D BASSI KALAN	D715FL14	MARU MANGAL	AMR	OK	31.03.2023	Category 5-UPS				3853	900-450/577/1-1-1	3.243	NA	Director/D	
B.4389	North	HOSHARPUR	11KV	DS DIVN. MAHILPUR	DS S/D BASSI KALAN	D715FL23	SODASAR	AMR	OK	31.03.2023	Category 5-UPS				37699	900-450/577/1-1-1	4.426	NA	Director/D	
B.4390	North	HOSHARPUR	11KV	DS DIVN. MAHILPUR	DS S/D BASSI KALAN	D715FL1D	Naurangabad	AMR	OK	31.03.2023	Kandi Mixed				37699	900-450/577/1-1-1	4.478	NA	Director/D	
B.4391	North	HOSHARPUR	11KV	DS DIVN. MAHILPUR	DS S/D BASSI KALAN	D715FL11	BOHAN	AMR	OK	31.03.2023	Kandi Mixed				37699	900-450/577/1-1-1	4.635	NA	Director/D	
B.4392	North	HOSHARPUR	11KV	DS DIVN. MAHILPUR	DS S/D BASSI KALAN	D715FL19	MEHLANWALI	AMR	OK	31.03.2023	Kandi Pure AP				37699	900-450/577/1-1-1	5.123	NA</		

S.No	Zone	Circle	Voltage Level (kVA)	Division (kVA)	Sub-Division (kVA)	Feeder ID	Feeder Name	Feeder Metering Status (Metered/unmetered/AMR/AMI)	Status of Meter (Functional/Non-functional)	Metering Date	Date of last actual meter reading/communication	Feeder Type (Agr/Industrial/Mixed)	Status of Communication			Period from 01.04.2021 to 31.03.2022				Sales	Remarks (Source of data)
													% data received through automatically if feeder AMR/AMI	Number of hours when meter was unable to communicate in overall	Total Number of hours in the period	Meter S.No	CT/Ratio	Import (kU)	Export (kU)		
B.4432	North	HOSHARPUR	11KV	DS DIVN. MAHILPUR	DS S/D PALDI	E712FL13	RAMPUR	AMR	OK	31.03.2023		AP 3Phase 3Wire				12479404	900-450/577/1-1-1	2.868	NA	Director/D	
B.4433	North	HOSHARPUR	11KV	DS DIVN. MAHILPUR	DS S/D PALDI	E712FL12	NURPUR	AMR	OK	31.03.2023		AP 3Phase 3Wire				9154171	900-450/577/1-1-1	3.714	NA	Director/D	
B.4434	North	HOSHARPUR	11KV	DS DIVN. MAHILPUR	DS S/D PALDI	E712FL16	RHARDGUDI	AMR	OK	31.03.2023		Kandi Mixed				2066219	900-450/577/1-1-1	6.916	NA	Director/D	
B.4435	North	HOSHARPUR	11KV	DS DIVN. MAHILPUR	DS S/D PALDI	E712FL11	SIWNI	AMR	OK	31.03.2023		Category 5-UPS				12179413	900-450/577/1-1-1	8.833	NA	Director/D	
B.4436	North	HOSHARPUR	11KV	DS DIVN. MAHILPUR	DS S/D PALDI	E712FL07	Khusalpur	AMR	OK	31.03.2023		Category 5-UPS				2068475	900-450/577/1-1-1	8.845	NA	Director/D	
B.4437	North	HOSHARPUR	11KV	DS DIVN. MAHILPUR	DS S/D PALDI	E712FL05	Kot Fatuhi	Not available	OK	31.03.2023		Category 5-UPS				2068280	900-450/577/1-1-1	12.606	NA	Director/D	
B.4438	North	HOSHARPUR	11KV	DS DIVN. MAHILPUR	DS S/D PALDI	E709FL04	Lakshian	Not available	OK	31.03.2023		Kandi Mixed				Not available	Not available	1.831	NA	Director/D	
B.4439	North	HOSHARPUR	11KV	DS DIVN. MAHILPUR	DS S/D PALDI	E712FL14	RALPUR	Not available	OK	31.03.2023		Kandi Mixed				Not available	Not available	2.520	NA	Director/D	
B.4440	North	HOSHARPUR	11KV	DS DIVN. MAHILPUR	DS S/D PALDI	E712FL15	KALUPUR	Not available	OK	31.03.2023		Kandi Mixed				Not available	Not available	3.135	NA	Director/D	
B.4441	North	HOSHARPUR	11KV	DS DIVN. MAHILPUR	DS S/D PALDI	E712FL02	Nadigar	Not available	OK	31.03.2023		Kandi Mixed				Not available	Not available	4.144	NA	Director/D	
B.4442	North	HOSHARPUR	11KV	DS DIVN. MAHILPUR	DS S/D PALDI	E712FL09	Esapur	Not available	OK	31.03.2023		Kandi Mixed				Not available	Not available	4.490	NA	Director/D	
B.4443	North	HOSHARPUR	11KV	DS DIVN. MAHILPUR	DS S/D PALDI	E709FL08	LALPUR BHANA	Not available	OK	31.03.2023		Kandi Mixed				Not available	Not available	4.734	NA	Director/D	
B.4444	North	HOSHARPUR	11KV	DS DIVN. MAHILPUR	DS S/D PALDI	E712FL01	Dhada	AMR	OK	31.03.2023		Kandi Mixed				Not available	Not available	5.007	NA	Director/D	
B.4445	North	HOSHARPUR	11KV	DS DIVN. MAHILPUR	DS S/D SAILA KHURD	E702FL16	GUJARPUR	AMR	OK	31.03.2023		Kandi Mixed				0	900-450/577/1-1-1	7.978	NA	Director/D	
B.4446	North	HOSHARPUR	11KV	DS DIVN. MAHILPUR	DS S/D SAILA KHURD	E712FL04	JAISON	NON AMR	OK	31.03.2023		Kandi Mixed				10273740	900-450/577/1-1-1	5.965	NA	Director/D	
B.4447	North	HOSHARPUR	11KV	DS DIVN. MAHILPUR	DS S/D SAILA KHURD	E712FL03	RAILWAY STATION	NON AMR	OK	31.03.2023		Kandi Mixed				10273732	900-450/577/1-1-1	10.684	NA	Director/D	
B.4448	North	HOSHARPUR	11KV	DS DIVN. MAHILPUR	DS S/D SAILA KHURD	E712FL02	MEGHOWAL	NON AMR	OK	31.03.2023		Kandi Mixed				10273745	900-450/577/1-1-1	11.878	NA	Director/D	
B.4449	North	HOSHARPUR	11KV	DS DIVN. MAHILPUR	DS S/D SAILA KHURD	E712FL02	PADDI SURA SINGH	NON AMR	OK	31.03.2023		Kandi Mixed				7035647	900-450/577/1-1-1	4.325	NA	Director/D	
B.4450	North	HOSHARPUR	11KV	DS DIVN. MAHILPUR	DS S/D SAILA KHURD	E712FL08	PENSA	AMR	OK	31.03.2023		Kandi Mixed				9154146	900-450/577/1-1-1	6.156	NA	Director/D	
B.4451	North	HOSHARPUR	11KV	DS DIVN. MAHILPUR	DS S/D SAILA KHURD	E712FL05	SAILA CITY	AMR	OK	31.03.2023		Category 1				5437501	900-450/577/1-1-1	6.458	NA	Director/D	
B.4452	North	HOSHARPUR	11KV	DS DIVN. MAHILPUR	DS S/D SAILA KHURD	E712FL08	POSSI	NON AMR	OK	31.03.2023		Kandi Mixed				9154146	900-450/577/1-1-1	6.718	NA	Director/D	
B.4453	North	HOSHARPUR	11KV	DS DIVN. MAHILPUR	DS S/D SAILA KHURD	E712FL09	MAZARA DINGRAN	NON AMR	OK	31.03.2023		Kandi Mixed				11117314	900-450/577/1-1-1	8.316	NA	Director/D	
B.4454	North	HOSHARPUR	11KV	DS DIVN. MAHILPUR	DS S/D SAILA KHURD	E712FL07	JASSOWAL	NON AMR	OK	31.03.2023		Kandi Mixed				6489720	900-450/577/1-1-1	8.776	NA	Director/D	
B.4455	North	HOSHARPUR	11KV	DS DIVN. MAHILPUR	DS S/D SAILA KHURD	E712FL04	PAKHOWAL	Not available	OK	31.03.2023		Kandi Mixed				7030226	900-450/577/1-1-1	10.332	NA	Director/D	
B.4456	North	HOSHARPUR	6KV	DS DIVN. MAHILPUR	DS S/D SAILA KHURD	E712FL01	KUNTALUM PAPER LTD	NON AMR	OK	31.03.2023		Category 4				Not available	Not available	7.017	NA	Director/D	
B.4457	North	HOSHARPUR	11KV	DS DIVN. MUKERIAN	DS S/D BHANGALA	E706FL17	11 kv kati	NON AMR	OK	31.03.2023		Category 5-UPS				20682417	900-450/577/1-1-1	0.058	NA	Director/D	
B.4458	North	HOSHARPUR	11KV	DS DIVN. MUKERIAN	DS S/D BHANGALA	E706FL18	11 kv Aiyal sahib	AMR	OK	31.03.2023		Kandi Pure AP				13190549	900-450/577/1-1-1	0.165	NA	Director/D	
B.4459	North	HOSHARPUR	11KV	DS DIVN. MUKERIAN	DS S/D BHANGALA	E706FL15	Bhangali	AMR	OK	31.03.2023		Kandi Pure AP				2068343	900-450/577/1-1-1	0.178	NA	Director/D	
B.4460	North	HOSHARPUR	11KV	DS DIVN. MUKERIAN	DS S/D BHANGALA	E706FL16	11 KV Dhokalehra	AMR	OK	31.03.2023		Kandi Pure AP				6489705	900-450/577/1-1-1	0.469	NA	Director/D	
B.4461	North	HOSHARPUR	11KV	DS DIVN. MUKERIAN	DS S/D BHANGALA	E706FL05	Bathpur	AMR	OK	31.03.2023		AP 3Phase 3Wire				7336660	900-450/577/1-1-1	1.641	NA	Director/D	
B.4462	North	HOSHARPUR	11KV	DS DIVN. MUKERIAN	DS S/D BHANGALA	E706FL02	MANSUR	NON AMR	OK	31.03.2023		AP 3Phase 3Wire				6679925	900-450/577/1-1-1	1.684	NA	Director/D	
B.4463	North	HOSHARPUR	11KV	DS DIVN. MUKERIAN	DS S/D BHANGALA	E706FL13	Rajaur UPS	AMR	OK	31.03.2023		Category 5-UPS				2068343	900-450/577/1-1-1	3.925	NA	Director/D	
B.4464	North	HOSHARPUR	11KV	DS DIVN. MUKERIAN	DS S/D BHANGALA	E706FL10	11kv Jandwal UPS	AMR	OK	31.03.2023		Category 5-UPS				5117	900-450/577/1-1-1	4.467	NA	Director/D	
B.4465	North	HOSHARPUR	11KV	DS DIVN. MUKERIAN	DS S/D BHANGALA	E706FL12	11kv Bebbhmanj UPS	NON AMR	OK	31.03.2023		Category 5-UPS				5111	900-450/577/1-1-1	4.557	NA	Director/D	
B.4466	North	HOSHARPUR	11KV	DS DIVN. MUKERIAN	DS S/D BHANGALA	E706FL06	MANIPUR	AMR	OK	31.03.2023		Category 5-UPS				2068543	900-450/577/1-1-1	6.397	NA	Director/D	
B.4467	North	HOSHARPUR	11KV	DS DIVN. MUKERIAN	DS S/D BHANGALA	E706FL14	11kv Mhashubpur UPS	NON AMR	OK	31.03.2023		Category 5-UPS				73210398	900-450/577/1-1-1	7.007	NA	Director/D	
B.4468	North	HOSHARPUR	11KV	DS DIVN. MUKERIAN	DS S/D BHANGALA	E706FL07	PALAKI	AMR	OK	31.03.2023		Category 5-UPS				20682417	900-450/577/1-1-1	7.765	NA	Director/D	
B.4469	North	HOSHARPUR	11KV	DS DIVN. MUKERIAN	DS S/D BHANGALA	E706FL08	MAHANDPUR	AMR	OK	31.03.2023		AP 3Phase 3Wire				3921	900-450/577/1-1-1	0.853	NA	Director/D	
B.4470	North	HOSHARPUR	11KV	DS DIVN. MUKERIAN	DS S/D BHANGALA	E704FL07	11 kv Mahadpur	NON AMR	OK	31.03.2023		Kandi Pure AP				1619904643	900-450/577/1-1-1	0.041	NA	Director/D	
B.4471	North	HOSHARPUR	11KV	DS DIVN. MUKERIAN	DS S/D BHANGALA	E704FL06	11 kv Jhareran	AMR	OK	31.03.2023		Kandi Pure AP				16199340	900-450/577/1-1-1	0.078	NA	Director/D	
B.4472	North	HOSHARPUR	11KV	DS DIVN. MUKERIAN	DS S/D BHANGALA	E704FL05	11kv Chanpur UPS	AMR	OK	31.03.2023		Category 5-UPS				5117	900-450/577/1-1-1	3.709	NA	Director/D	
B.4473	North	HOSHARPUR	11KV	DS DIVN. MUKERIAN	DS S/D BHANGALA	E706FL38	NEISHA PATAN	Not available	OK	31.03.2023		AP 3Phase 3Wire				5342133	900-450/577/1-1-1	1.322	NA	Director/D	
B.4474	North	HOSHARPUR	11KV	DS DIVN. MUKERIAN	DS S/D BHANGALA	E704FL04	MANGALPUR	Not available	OK	31.03.2023		Kandi Mixed				Not available	Not available	1.334	NA	Director/D	
B.4475	North	HOSHARPUR	11KV	DS DIVN. MUKERIAN	DS S/D BHANGALA	E704FL03	JHAREAN	Not available	OK	31.03.2023		Kandi Mixed				Not available	Not available	0.884	NA	Director/D	
B.4476	North	HOSHARPUR	11KV	DS DIVN. MUKERIAN	DS S/D BHANGALA	E706FL07	ATYAL SAHIB	Not available	OK	31.03.2023		Kandi Mixed				Not available	Not available	1.028	NA	Director/D	
B.4477	North	HOSHARPUR	11KV	DS DIVN. MUKERIAN	DS S/D BHANGALA	E706FL03	BHANGALI	Not available	OK	31.03.2023		Kandi Mixed				Not available	Not available	1.134	NA	Director/D	
B.4478	North	HOSHARPUR	11KV	DS DIVN. MUKERIAN	DS S/D BHANGALA	E706FL01	KOTLI	Not available	OK	31.03.2023		Kandi Mixed				Not available	Not available	1.149	NA	Director/D	
B.4479	North	HOSHARPUR	11KV	DS DIVN. MUKERIAN	DS S/D BHANGALA	E706FL04	Dhokalehra	NON AMR	OK	31.03.2023		Kandi Mixed				Not available	Not available	2.468	NA	Director/D	
B.4480	North	HOSHARPUR	11KV	DS DIVN. MUKERIAN	DS S/D DATARPUR	E709FL24	SUKHAINPUR	NON AMR	OK	31.03.2023		Kandi Mixed				224	900-450/577/1-1-1	5.468	NA	Director/D	
B.4481	North	HOSHARPUR	11KV	DS DIVN. MUKERIAN	DS S/D DATARPUR	E709FL48	KAMHI DEVI	AMR	OK	31.03.2023		Kandi Mixed				7042891	900-450/577/1-1-1	5.860	NA	Director/D	
B.4482	North	HOSHARPUR	11KV	DS DIVN. MUKERIAN	DS S/D DATARPUR	E709FL05	DATARPUR	NON AMR	OK	31.03.2023		Kandi Mixed				4180066	900-450/577/1-1-1	10.842	NA	Director/D	
B.4483	North	HOSHARPUR	11KV	DS DIVN. MUKERIAN	DS S/D HAZIPUR	E704FL01	BUDHABAR	NON AMR	OK	31.03.2023		Kandi Mixed				16199524	900-450/577/1-1-1	3.141	NA	Director/D	
B.4484	North	HOSHARPUR	11KV	DS DIVN. MUKERIAN	DS S/D HAZIPUR	E704FL02	PANUPUR	NON AMR	OK	31.03.2023		Kandi Mixed				16199443	900-450/577/1-1-1	4.006	NA	Director/D	
B.4485	North	HOSHARPUR	11KV	DS DIVN. MUKERIAN	DS S/D HAZIPUR	E712FL16	KANGAL BHALAN	NON AMR	OK	31.03.2023		Kandi Mixed				10288376	900-450/577/1-1-1	4.602	NA	Director/D	
B.4486	North	HOSHARPUR	11KV	DS DIVN. MUKERIAN	DS S/D HAZIPUR	E707FL50	MPH NO. 384	NON AMR	OK	31.03.2023		Category 1				11117028	900-450/577/1-1-1	0.194	NA	Director/D	
B.4487	North	HOSHARPUR	11KV	DS DIVN. MUKERIAN	DS S/D HAZIPUR	E707FL57	dhade katwal	NON AMR	OK	31.03.2023		Kandi Mixed				0	900-450/577/1-1-1	2.035	NA	Director/D	
B.4488	North	HOSHARPUR	11KV	DS DIVN. MUKERIAN	DS S/D HAZIPUR	E707FL55	GERA	AMR	OK	31.03.2023		Kandi Mixed				4187890	900-450/577/1-1-1	2.176	NA	Director/D	
B.4489	North	HOSHARPUR	11KV	DS DIVN. MUKERIAN	DS S/D HAZIPUR	E707FL13	HANDHAWA UPS	AMR	OK	31.03.2023		Category 5-UPS				2022202	900-450/577/1-1-1	3.280	NA	Director/D	
B.4490	North	HOSHARPUR	11KV	DS DIVN. MUKERIAN	DS S/D HAZIPUR	E707FL15	SARANA	NON AMR	OK	31.03.2023		Category 5-UPS				310763084	900-450/577/1-1-1	3.406	NA	Director/D	
B.4491	North	HOSHARPUR	11KV	DS DIVN. MUKERIAN	DS S/D HAZIPUR	E707FL14	WAZIRAN	NON AMR	OK	31.03.2023		Category 5-UPS				742029	900-450/577/1-1-1	4.025	NA	Director/D	
B.4492	North	HOSHARPUR	11KV	DS DIVN. MUKERIAN	DS S/D HAZIPUR	E707FL52	SAWAR	NON AMR	OK	31.03.2023		Kandi Mixed				7336450	900-450/577/1-1-1	4.693	NA	Director/D	
B.4493	North	HOSHARPUR	11KV	DS DIVN. MUKERIAN	DS S/D HAZIPUR	E707FL51	khunda	AMR	OK	31.03.2023		Kandi Mixed				2068411	900-450/577/1-1-1	4.808	NA	Director/D	
B.4494	North	HOSHARPUR	11KV	DS DIVN. MUKERIAN	DS S/D HAZIPUR	E707FL10	HAJIPUR	NON AMR	OK	31.03.2023		Kandi Mixed				11114472	900-450/577/1-1-1	4.901	NA	Director/D	
B.4495	North	HOSHARPUR	11KV	DS DIVN. MUKERIAN	DS S/D HAZIPUR	E707FL06	KHAZIPUR	NON AMR	OK	31.03.2023		Kandi Mixed				4187928	900-450/577/1-1-1	8.039	NA	Director/D	
B.4496	North	HOSHARPUR	11KV	DS DIVN. MUK																	

S.No	Zone	Circle	Voltage Level (kVA)	Division (kVA)	Sub-Division (kVA)	Feeder ID	Feeder Name	Feeder Metering Status (Metered/unmetered/AMR/AMI)	Status of Meter (Functional/Non-functional)	Metering Date	Date of last actual meter reading/communication	Feeder Type (Agr/Industrial/Mixed)	Status of Communication			Period from 01.04.2021 to 31.03.2022				Sales	Remarks (Source of data)
													% data received through automatically by feeder AMR/AMI	Number of hours when meter was unable to communicate in overall	Total Number of hours in the period	Meter S.No	CT/Ratio	Import (kWh)	Export (kWh)		
B.4529	North	HOSHARPUR	11KV	DS DIVN. MUKERIAN	DS S/D TALWARA	D709FL42	SHAH NEHR	AMR	OK	31.03.2023		Category 1				2066484	900-450/577/1-1-1	0.049	NA	Director/D	
B.4530	North	HOSHARPUR	11KV	DS DIVN. MUKERIAN	DS S/D TALWARA	D709FL44	MPH1	AMR	OK	31.03.2023		Category 1			9154153	900-450/577/1-1-1	0.085	NA	Director/D		
B.4531	North	HOSHARPUR	11KV	DS DIVN. MUKERIAN	DS S/D TALWARA	D709FL47	NEHRUR	NON AMR	OK	31.03.2023		Kandi Mixed			3299	900-450/577/1-1-1	5.001	NA	Director/D		
B.4532	North	HOSHARPUR	11KV	DS DIVN. MUKERIAN	DS S/D TALWARA	D709FL41	SATHNAM	NON AMR	OK	31.03.2023		Kandi Mixed			7042920	900-450/577/1-1-1	6.632	NA	Director/D		
B.4533	North	HOSHARPUR	11KV	DS DIVN. MUKERIAN	DS S/D TALWARA	D709FL39	BHAMBOTAR	AMR	OK	31.03.2023		Kandi Mixed			7042922	900-450/577/1-1-1	7.557	NA	Director/D		
B.4534	North	HOSHARPUR	11KV	DS DIVN. MUKERIAN	DS S/D TALWARA	D709FL40	TALWARA	NON AMR	OK	31.03.2023		Kandi Mixed			4180070	900-450/577/1-1-1	7.600	NA	Director/D		
B.4535	North	HOSHARPUR	11KV	DS S/U DIVN. HSP	DS S/D ATTOWAL	D709FL05	M/S PUNJAB FORMULATION LTD.	AMR	OK	31.03.2023		Category 4			12479841	900-450/577/1-1-1	0.000	NA	Director/D		
B.4536	North	HOSHARPUR	11KV	DS S/U DIVN. HSP	DS S/D ATTOWAL	D714FL12	AHRANA KALAN AP	NON AMR	OK	31.03.2023		AP 3Phase 3Wire			5443	900-450/577/1-1-1	0.105	NA	Director/D		
B.4537	North	HOSHARPUR	11KV	DS S/U DIVN. HSP	DS S/D ATTOWAL	D709FL06	ATTOWAL	AMR	OK	31.03.2023		AP 3Phase 3Wire			11116993	900-450/577/1-1-1	1.736	NA	Director/D		
B.4538	North	HOSHARPUR	11KV	DS S/U DIVN. HSP	DS S/D ATTOWAL	D709FL02	RAIPUR	AMR	OK	31.03.2023		AP 3Phase 3Wire			2067507	900-450/577/1-1-1	2.614	NA	Director/D		
B.4539	North	HOSHARPUR	11KV	DS S/U DIVN. HSP	DS S/D ATTOWAL	D706FL11	SAHRI	AMR	OK	31.03.2023		AP 3Phase 3Wire			4686	900-450/577/1-1-1	3.099	NA	Director/D		
B.4540	North	HOSHARPUR	11KV	DS S/U DIVN. HSP	DS S/D ATTOWAL	D706FL08	BHATRANA	AMR	OK	31.03.2023		AP 3Phase 3Wire			6489150	900-450/577/1-1-1	3.475	NA	Director/D		
B.4541	North	HOSHARPUR	11KV	DS S/U DIVN. HSP	DS S/D ATTOWAL	D706FL01	MONA	AMR	OK	31.03.2023		AP 3Phase 3Wire			8223313	900-450/577/1-1-1	3.492	NA	Director/D		
B.4542	North	HOSHARPUR	11KV	DS S/U DIVN. HSP	DS S/D ATTOWAL	D706FL03	MEHMOWAL	AMR	OK	31.03.2023		AP 3Phase 3Wire			4179724	900-450/577/1-1-1	3.922	NA	Director/D		
B.4543	North	HOSHARPUR	11KV	DS S/U DIVN. HSP	DS S/D ATTOWAL	D706FL09	DUGAR	AMR	OK	31.03.2023		AP 3Phase 3Wire			8223312	900-450/577/1-1-1	4.216	NA	Director/D		
B.4544	North	HOSHARPUR	11KV	DS S/U DIVN. HSP	DS S/D ATTOWAL	D703FL10	Tajawal	NON AMR	OK	31.03.2023		Category 5-UPS			8223313	900-450/577/1-1-1	5.463	NA	Director/D		
B.4545	North	HOSHARPUR	11KV	DS S/U DIVN. HSP	DS S/D ATTOWAL	D706FL07	HARKOWAL	NON AMR	OK	31.03.2023		Category 1			6675939	900-450/577/1-1-1	5.615	NA	Director/D		
B.4546	North	HOSHARPUR	11KV	DS S/U DIVN. HSP	DS S/D ATTOWAL	D706FL06	MANA	AMR	OK	31.03.2023		Category 5-UPS			6740738	900-450/577/1-1-1	10.559	NA	Director/D		
B.4547	North	HOSHARPUR	11KV	DS S/U DIVN. HSP	DS S/D ATTOWAL	D706FL07	MUKHLANA	AMR	OK	31.03.2023		Category 5-UPS			8223312	900-450/577/1-1-1	10.684	NA	Director/D		
B.4548	North	HOSHARPUR	11KV	DS S/U DIVN. HSP	DS S/D ATTOWAL	D714FL11	11KV CHOKH WALA	AMR	OK	31.03.2023		AP 3Phase 3Wire			22222	900-450/577/1-1-1	1.463	NA	Director/D		
B.4549	North	HOSHARPUR	11KV	DS S/U DIVN. HSP	DS S/D ATTOWAL	D714FL05	BADLA	NON AMR	OK	31.03.2023		Category 1			9534488	900-450/577/1-1-1	1.940	NA	Director/D		
B.4550	North	HOSHARPUR	11KV	DS S/U DIVN. HSP	DS S/D ATTOWAL	D714FL01	HUKRAN	AMR	OK	31.03.2023		AP 3Phase 3Wire			10281324	900-450/577/1-1-1	2.739	NA	Director/D		
B.4551	North	HOSHARPUR	11KV	DS S/U DIVN. HSP	DS S/D ATTOWAL	D714FL06	Stempur	NON AMR	OK	31.03.2023		AP 3Phase 3Wire			33662	900-450/577/1-1-1	3.706	NA	Director/D		
B.4552	North	HOSHARPUR	11KV	DS S/U DIVN. HSP	DS S/D ATTOWAL	D714FL04	PANDORI KAD	AMR	OK	31.03.2023		AP 3Phase 3Wire			11069757	900-450/577/1-1-1	4.078	NA	Director/D		
B.4553	North	HOSHARPUR	11KV	DS S/U DIVN. HSP	DS S/D ATTOWAL	D717FL05	PURHARAN RURAL	AMR	OK	31.03.2023		Category 1			6676970	900-450/577/1-1-1	2.970	NA	Director/D		
B.4554	North	HOSHARPUR	11KV	DS S/U DIVN. HSP	DS S/D ATTOWAL	D717FL03	PURHARAN URBAN	NON AMR	OK	31.03.2023		Category 1			5295544	900-450/577/1-1-1	9.114	NA	Director/D		
B.4555	North	HOSHARPUR	11KV	DS S/U DIVN. HSP	DS S/D REHANA JATTAN	D704FL17	Amrit Dura Parts Simbli	AMR	OK	31.03.2023		Category 4			84	900-450/577/1-1-1	0.000	NA	Director/D		
B.4556	North	HOSHARPUR	11KV	DS S/U DIVN. HSP	DS S/D REHANA JATTAN	D704FL24	MEHTANA	NON AMR	OK	31.03.2023		AP 3Phase 3Wire			11117158	1200/577/1-1-1	1.542	NA	Director/D		
B.4557	North	HOSHARPUR	11KV	DS S/U DIVN. HSP	DS S/D REHANA JATTAN	D704FL19	PHUGLALA-2	NON AMR	OK	31.03.2023		AP 3Phase 3Wire			11114601	1200/577/1-1-1	1.750	NA	Director/D		
B.4558	North	HOSHARPUR	11KV	DS S/U DIVN. HSP	DS S/D REHANA JATTAN	D704FL13	PHUGLALA-1	NON AMR	OK	31.03.2023		AP 3Phase 3Wire			11114588	1200/577/1-1-1	2.320	NA	Director/D		
B.4559	North	HOSHARPUR	11KV	DS S/U DIVN. HSP	DS S/D REHANA JATTAN	D704FL10	MUSAPUR	NON AMR	OK	31.03.2023		AP 3Phase 3Wire			103	1200/577/1-1-1	2.915	NA	Director/D		
B.4560	North	HOSHARPUR	11KV	DS S/U DIVN. HSP	DS S/D REHANA JATTAN	D704FL20	LUTERA DOHALTA	NON AMR	OK	31.03.2023		Category 1			117	900-450/577/1-1-1	3.372	NA	Director/D		
B.4561	North	HOSHARPUR	11KV	DS S/U DIVN. HSP	DS S/D REHANA JATTAN	D704FL09	LUTERA	NON AMR	OK	31.03.2023		AP 3Phase 3Wire			72	900-450/577/1-1-1	3.453	NA	Director/D		
B.4562	North	HOSHARPUR	11KV	DS S/U DIVN. HSP	DS S/D REHANA JATTAN	D704FL11	SANGATPUR	NON AMR	OK	31.03.2023		AP 3Phase 3Wire			8222648	1200/577/1-1-1	3.745	NA	Director/D		
B.4563	North	HOSHARPUR	11KV	DS S/U DIVN. HSP	DS S/D REHANA JATTAN	D704FL16	UCHA BHABIANA	AMR	OK	31.03.2023		AP 3Phase 3Wire			90	900-450/577/1-1-1	3.909	NA	Director/D		
B.4564	North	HOSHARPUR	11KV	DS S/U DIVN. HSP	DS S/D REHANA JATTAN	D704FL27	11KV SUKHIT CORN PRODUCT	NON AMR	OK	31.03.2023		Category 4			3657	400-200/5-5	4.492	NA	Director/D		
B.4565	North	HOSHARPUR	11KV	DS S/U DIVN. HSP	DS S/D REHANA JATTAN	D704FL06	UCHA	AMR	OK	31.03.2023		AP 3Phase 3Wire			3681	900-450/577/1-1-1	5.262	NA	Director/D		
B.4566	North	HOSHARPUR	11KV	DS S/U DIVN. HSP	DS S/D REHANA JATTAN	D704FL26	SUKHIT MAGA FOOD-1	NON AMR	OK	31.03.2023		Category 2			3681	400-200/5-5	5.724	NA	Director/D		
B.4567	North	HOSHARPUR	11KV	DS S/U DIVN. HSP	DS S/D REHANA JATTAN	D704FL05	REHANA JATTAN-2	NON AMR	OK	31.03.2023		Category 5-UPS			11114571	1200/577/1-1-1	6.538	NA	Director/D		
B.4568	North	HOSHARPUR	11KV	DS S/U DIVN. HSP	DS S/D REHANA JATTAN	D704FL14	RAWAL PINDI	NON AMR	OK	31.03.2023		Category 5-UPS			11114567	1200/577/1-1-1	9.058	NA	Director/D		
B.4569	North	HOSHARPUR	11KV	DS S/U DIVN. HSP	DS S/D REHANA JATTAN	D704FL02	REHANA JATTAN-1	AMR	OK	31.03.2023		Category 5-UPS			4221205	900-450/577/1-1-1	11.182	NA	Director/D		
B.4570	North	HOSHARPUR	11KV	DS S/U DIVN. HSP	DS S/D REHANA JATTAN	D704FL23	PRETIA ENGG COMPONENTS	AMR	OK	31.03.2023		Category 5-UPS			3984	900-450/577/1-1-1	11.817	NA	Director/D		
B.4571	North	HOSHARPUR	11KV	DS S/U DIVN. HSP	DS S/D REHANA JATTAN	D704FL16	CHODHA	AMR	OK	31.03.2023		Category 5-UPS			10261290	900-450/577/1-1-1	2.025	NA	Director/D		
B.4572	North	HOSHARPUR	11KV	DS S/U DIVN. HSP	DS S/D REHANA JATTAN	D563FL12	DHANDORI	AMR	OK	31.03.2023		AP 3Phase 3Wire			774455	600/577/1-1-1	3.714	NA	Director/D		
B.4573	North	HOSHARPUR	11KV	DS S/U DIVN. HSP	DS S/D REHANA JATTAN	D561FL10	BOHANI	NON AMR	OK	31.03.2023		AP 3Phase 3Wire			2047049	600/577/1-1-1	3.577	NA	Director/D		
B.4574	North	HOSHARPUR	11KV	DS S/U DIVN. HSP	DS S/D REHANA JATTAN	D561FL08	NOLI	AMR	OK	31.03.2023		AP 3Phase 3Wire			9534489	600/577/1-1-1	4.504	NA	Director/D		
B.4575	North	HOSHARPUR	11KV	DS S/U DIVN. HSP	DS S/D REHANA JATTAN	D561FL15	SHROWAL	Not available	OK	31.03.2023		Category 5-UPS			6679885	600/577/1-1-1	5.836	NA	Director/D		
B.4576	North	HOSHARPUR	66KV	DS S/D DIVN. HSP	DS S/D REHANA JATTAN	D704FL22	GM Gulab Gerh Unit 2	Not available	OK	31.03.2023		Category 4			Not available	Not available	60.873	NA	Director/D		
B.4577	North	HOSHARPUR	66KV	DS S/D DIVN. HSP	DS S/D REHANA JATTAN	D704FL03	GM AXLE	AMR	OK	31.03.2023		Category 4			Not available	Not available	90.893	NA	Director/D		
B.4578	North	HOSHARPUR	11KV	DS S/U DIVN. HSP	DS S/D SHAM CHURASI	D728FL06	SEHOHWAL	AMR	OK	31.03.2023		AP 3Phase 3Wire			3880	900-450/577/1-1-1	1.846	NA	Director/D		
B.4579	North	HOSHARPUR	11KV	DS S/U DIVN. HSP	DS S/D SHAM CHURASI	D718FL11	KURANGNA	AMR	OK	31.03.2023		AP 3Phase 3Wire			4655	900-450/577/1-1-1	2.205	NA	Director/D		
B.4580	North	HOSHARPUR	11KV	DS S/U DIVN. HSP	DS S/D SHAM CHURASI	D707FL02	MEGHOWAL	AMR	OK	31.03.2023		AP 3Phase 3Wire			8223146	900-450/577/1-1-1	2.815	NA	Director/D		
B.4581	North	HOSHARPUR	11KV	DS S/U DIVN. HSP	DS S/D SHAM CHURASI	D707FL06	PELAN	AMR	OK	31.03.2023		Category 5-UPS			2047198	900-450/577/1-1-1	8.394	NA	Director/D		
B.4582	North	HOSHARPUR	11KV	DS S/U DIVN. HSP	DS S/D SHAM CHURASI	D728FL17	PANDORI RAJPUTTAN	AMR	OK	31.03.2023		AP 3Phase 3Wire			31.023	900-450/577/1-1-1	1.023	NA	Director/D		
B.4583	North	HOSHARPUR	11KV	DS S/U DIVN. HSP	DS S/D SHAM CHURASI	D708FL15	KOHA	AMR	OK	31.03.2023		AP 3Phase 3Wire			3578	900-450/577/1-1-1	1.285	NA	Director/D		
B.4584	North	HOSHARPUR	11KV	DS S/U DIVN. HSP	DS S/D SHAM CHURASI	D708FL02	PANDORI BHAWA	AMR	OK	31.03.2023		AP 3Phase 3Wire			9140789	900-450/577/1-1-1	2.156	NA	Director/D		
B.4585	North	HOSHARPUR	11KV	DS S/U DIVN. HSP	DS S/D SHAM CHURASI	D708FL11	BADALA MAHI	AMR	OK	31.03.2023		AP 3Phase 3Wire			12479718	900-450/577/1-1-1	2.445	NA	Director/D		
B.																					

S.No	Zone	Circle	Voltage Level (kVA)	Division (kVA)	Sub-Division (kVA)	Feeder ID	Feeder Name	Feeder Metering Status (Metered/unmetered/AMR/AM)	Status of Meter (Functional/Non-Functional)	Metering Date (Date of last actual meter reading/communication)	Feeder Type (Agr/Industrial/Mixed)	Status of Communication			Period from 01.04.2021 to 31.03.2022				Sales	Remarks (Source of data)
												% data received through automatically if feeder AMR/AM	Number of hours when meter was unable to communicate in period	Total Number of hours in the period	Meter S.No	CT/PT ratio	Import (MU)	Export (MU)		
B.4626	North	HOSHARPUR	33KV	DS S/U DIVN. HSP	DS S/U S/D HSP	C702FL13	USHA MARTIN	Not available	OK	31.03.2023	Category 4				Not available	Not available	16.978	NA	Director/D	
B.4627	North	HOSHARPUR	33KV	DS S/U DIVN. HSP	DS S/U S/D HSP	C702FL12	RELIANCE IND CHOHAL	Not available	OK	31.03.2023	Category 4				Not available	Not available	40.595	NA	Director/D	
B.4628	North	HOSHARPUR	33KV	DS S/U DIVN. HSP	DS S/U S/D HSP	C702C1	ICT LTD CHOHAL	Not available	OK	31.03.2023	Category 4				Not available	Not available	50.602	NA	Director/D	
B.4629	North	HOSHARPUR	66KV	DS S/U DIVN. HSP	DS S/U S/D HSP	C707FL09	ITI CHAK GUJAN	Not available	OK	31.03.2023	Category 1				Not available	Not available	52.213	NA	Director/D	
B.4630	North	JALANDHAR	11KV	DS Dvsn. Cantt. Jalandhar	DS S/D Tech-1 Cantt. Jalandhar	C553FL08	SG	NON AMR	OK	31.03.2023	Category 1				4530	900-450/5	2.243	NA	Director/D	
B.4631	North	JALANDHAR	11KV	DS Dvsn. Cantt. Jalandhar	DS S/D Tech-1 Cantt. Jalandhar	C554FL04	PIMS	NON AMR	OK	31.03.2023	Category 1				6679910	900-450/577/1-1	5.505	NA	Director/D	
B.4632	North	JALANDHAR	11KV	DS Dvsn. Cantt. Jalandhar	DS S/D Tech-1 Cantt. Jalandhar	C554FL02	JASWANT NAGAR	NON AMR	OK	31.03.2023	Category 1				5343273	900-450/577/1-1	7.427	NA	Director/D	
B.4633	North	JALANDHAR	11KV	DS Dvsn. Cantt. Jalandhar	DS S/D Tech-1 Cantt. Jalandhar	C554FL01	CHHOTI BARADARI	NON AMR	OK	31.03.2023	Category 1				6679905	900-450/577/1-1	8.750	NA	Director/D	
B.4634	North	JALANDHAR	11KV	DS Dvsn. Cantt. Jalandhar	DS S/D Tech-1 Cantt. Jalandhar	C553FL05	HIS	NON AMR	OK	31.03.2023	Category 1				73151041	900-450/5	11.824	NA	Director/D	
B.4635	North	JALANDHAR	11KV	DS Dvsn. Cantt. Jalandhar	DS S/D Tech-1 Cantt. Jalandhar	C553FL06	GOLDEN AVENUE	NON AMR	OK	31.03.2023	Category 1				4231149	1200/577/1-1	8.782	NA	Director/D	
B.4636	North	JALANDHAR	11KV	DS Dvsn. Cantt. Jalandhar	DS S/D Tech-1 Cantt. Jalandhar	8552FL02	BSF	NON AMR	OK	31.03.2023	Category 1				2066596	400-200/5	0.371	NA	Director/D	
B.4637	North	JALANDHAR	11KV	DS Dvsn. Cantt. Jalandhar	DS S/D Tech-1 Cantt. Jalandhar	00N1FL03	MIG	NON AMR	OK	31.03.2023	Category 1				526412	1200/577/1-1	7.019	NA	Director/D	
B.4638	North	JALANDHAR	11KV	DS Dvsn. Cantt. Jalandhar	DS S/D Tech-1 Cantt. Jalandhar	0559FL22	11 KV Cantt Mandi	NON AMR	OK	31.03.2023	Category 1				2556	900-450/5	4.101	NA	Director/D	
B.4639	North	JALANDHAR	11KV	DS Dvsn. Cantt. Jalandhar	DS S/D Tech-1 Cantt. Jalandhar	0559FL04	PAP	NON AMR	OK	31.03.2023	Category 1				15194750	1200-600/5	5.103	NA	Director/D	
B.4640	North	JALANDHAR	11KV	DS Dvsn. Cantt. Jalandhar	DS S/D Tech-1 Cantt. Jalandhar	0559FL07	CHURCH	NON AMR	OK	31.03.2023	Category 1				525322	1200-600/5	5.708	NA	Director/D	
B.4641	North	JALANDHAR	11KV	DS Dvsn. Cantt. Jalandhar	DS S/D Tech-1 Cantt. Jalandhar	0559FL01	GARHA	NON AMR	OK	31.03.2023	Category 1				15196561	1200-600/5	5.992	NA	Director/D	
B.4642	North	JALANDHAR	11KV	DS Dvsn. Cantt. Jalandhar	DS S/D Tech-1 Cantt. Jalandhar	0559FL21	11 KV Lal Kurti Feeder	NON AMR	OK	31.03.2023	Category 1				2552	900-450/5	7.120	NA	Director/D	
B.4643	North	JALANDHAR	11KV	DS Dvsn. Cantt. Jalandhar	DS S/D Tech-1 Cantt. Jalandhar	0559FL03	TU TOWER	AMR	OK	31.03.2023	Category 1				15194826	1200-600/5	8.800	NA	Director/D	
B.4644	North	JALANDHAR	11KV	DS Dvsn. Cantt. Jalandhar	DS S/D Rural Adampur, Jalandhar	0568FL16	BADALA	NON AMR	OK	31.03.2023	AP 3Phase 3Wire				4461	900-450/577/1-1	2.055	NA	Director/D	
B.4645	North	JALANDHAR	11KV	DS Dvsn. Cantt. Jalandhar	DS S/D Rural Adampur, Jalandhar	0568FL15	11KVMARVEED FEEDER	NON AMR	OK	31.03.2023	AP 3Phase 3Wire				15192383	600/577/1-1	1.197	NA	Director/D	
B.4646	North	JALANDHAR	11KV	DS Dvsn. Cantt. Jalandhar	DS S/D Rural Adampur, Jalandhar	0568FL12	YALU VIHAR	AMR	OK	31.03.2023	Category 4				8223831	600/577/1-1	1.851	NA	Director/D	
B.4647	North	JALANDHAR	11KV	DS Dvsn. Cantt. Jalandhar	DS S/D Rural Adampur, Jalandhar	0568FL04	DAROU KHURD	AMR	OK	31.03.2023	AP 3Phase 3Wire				8223446	600/577/1-1	1.963	NA	Director/D	
B.4648	North	JALANDHAR	11KV	DS Dvsn. Cantt. Jalandhar	DS S/D Rural Adampur, Jalandhar	0568FL08	DINGRIAN BADALA	AMR	OK	31.03.2023	AP 3Phase 3Wire				2067561	600/577/1-1	2.439	NA	Director/D	
B.4649	North	JALANDHAR	11KV	DS Dvsn. Cantt. Jalandhar	DS S/D Rural Adampur, Jalandhar	0568FL07	KAPOOR PIND	AMR	OK	31.03.2023	AP 3Phase 3Wire				2068559	600/577/1-1	2.933	NA	Director/D	
B.4650	North	JALANDHAR	11KV	DS Dvsn. Cantt. Jalandhar	DS S/D Rural Adampur, Jalandhar	0568FL03	CHULHARWAL	AMR	OK	31.03.2023	AP 3Phase 3Wire				2067475	600/577/1-1	3.324	NA	Director/D	
B.4651	North	JALANDHAR	11KV	DS Dvsn. Cantt. Jalandhar	DS S/D Rural Adampur, Jalandhar	0568FL02	HARIPUR	AMR	OK	31.03.2023	AP 3Phase 3Wire				2065641	600/577/1-1	3.457	NA	Director/D	
B.4652	North	JALANDHAR	11KV	DS Dvsn. Cantt. Jalandhar	DS S/D Rural Adampur, Jalandhar	0568FL01	KATHAR	AMR	OK	31.03.2023	AP 3Phase 3Wire				8223446	600/577/1-1	3.496	NA	Director/D	
B.4653	North	JALANDHAR	11KV	DS Dvsn. Cantt. Jalandhar	DS S/D Rural Adampur, Jalandhar	0568FL13	11KV UDESAN	AMR	OK	31.03.2023	Category 5-UPS				2066779	600/577/1-1	5.561	NA	Director/D	
B.4654	North	JALANDHAR	11KV	DS Dvsn. Cantt. Jalandhar	DS S/D Rural Adampur, Jalandhar	0568FL06	pasrdi	AMR	OK	31.03.2023	Category 4				2068343	600/577/1-1	5.767	NA	Director/D	
B.4655	North	JALANDHAR	11KV	DS Dvsn. Cantt. Jalandhar	DS S/D Rural Adampur, Jalandhar	0568FL09	chommon	AMR	OK	31.03.2023	Category 4				5342171	600/577/1-1	5.946	NA	Director/D	
B.4656	North	JALANDHAR	11KV	DS Dvsn. Cantt. Jalandhar	DS S/D Rural Adampur, Jalandhar	0568FL11	BAUWAL	NON AMR	OK	31.03.2023	Category 5-UPS				2067214	600/577/1-1	6.726	NA	Director/D	
B.4657	North	JALANDHAR	11KV	DS Dvsn. Cantt. Jalandhar	DS S/D Rural Adampur, Jalandhar	0568FL14	SEWANGI NAGAR	AMR	OK	31.03.2023	Category 1				4305	600/577/1-1	10.092	NA	Director/D	
B.4658	North	JALANDHAR	11KV	DS Dvsn. Cantt. Jalandhar	DS S/D Rural Adampur, Jalandhar	0568FL10	ADAMPUR	AMR	OK	31.03.2023	Category 1				5388129	600/577/1-1	11.988	NA	Director/D	
B.4659	North	JALANDHAR	11KV	DS Dvsn. Cantt. Jalandhar	DS S/D Rural Adampur, Jalandhar	0563FL17	11KV Airport	AMR	OK	31.03.2023	Category 4				15196550	400-200/5	0.110	NA	Director/D	
B.4660	North	JALANDHAR	11KV	DS Dvsn. Cantt. Jalandhar	DS S/D Rural Adampur, Jalandhar	0563FL15	11KV Daroli kalan	AMR	OK	31.03.2023	AP 3Phase 3Wire				777456	600/577/1-1	1.251	NA	Director/D	
B.4661	North	JALANDHAR	11KV	DS Dvsn. Cantt. Jalandhar	DS S/D Rural Adampur, Jalandhar	0563FL01	KANDOLA	NON AMR	OK	31.03.2023	AP 3Phase 3Wire				777657	600/577/1-1	1.467	NA	Director/D	
B.4662	North	JALANDHAR	11KV	DS Dvsn. Cantt. Jalandhar	DS S/D Rural Adampur, Jalandhar	0563FL05	ALAM FEEDER	AMR	OK	31.03.2023	AP 3Phase 3Wire				15196360	400-200/5	2.165	NA	Director/D	
B.4663	North	JALANDHAR	11KV	DS Dvsn. Cantt. Jalandhar	DS S/D Rural Adampur, Jalandhar	0563FL04	MANNO	NON AMR	OK	31.03.2023	AP 3Phase 3Wire				777848	600/577/1-1	2.272	NA	Director/D	
B.4664	North	JALANDHAR	11KV	DS Dvsn. Cantt. Jalandhar	DS S/D Rural Adampur, Jalandhar	0563FL02	JALPOT	NON AMR	OK	31.03.2023	AP 3Phase 3Wire				33414	400-200/5	2.848	NA	Director/D	
B.4665	North	JALANDHAR	11KV	DS Dvsn. Cantt. Jalandhar	DS S/D Rural Adampur, Jalandhar	0563FL14	11KVPadana	AMR	OK	31.03.2023	AP 3Phase 3Wire				33498	400-200/5	3.556	NA	Director/D	
B.4666	North	JALANDHAR	11KV	DS Dvsn. Cantt. Jalandhar	DS S/D Rural Adampur, Jalandhar	0563FL03	KALRA	NON AMR	OK	31.03.2023	Category 5-UPS				2047053	600/577/1-1	8.127	NA	Director/D	
B.4667	North	JALANDHAR	11KV	DS Dvsn. Cantt. Jalandhar	DS S/D Rural Adampur, Jalandhar	0563FL13	KHALA	AMR	OK	31.03.2023	Category 5-UPS				33499	400-200/5	9.240	NA	Director/D	
B.4668	North	JALANDHAR	11KV	DS Dvsn. Cantt. Jalandhar	DS S/D Rural Adampur, Jalandhar	0563FL04	NARHPUR	Not available	OK	31.03.2023	AP 3Phase 3Wire				2067568	600/577/1-1	3.235	NA	Director/D	
B.4669	North	JALANDHAR	66KV	DS Dvsn. Cantt. Jalandhar	DS S/D Rural Adampur, Jalandhar	0563C10	GE Air Force	AMR	OK	31.03.2023	Category 4				Not available	Not available	10.929	NA	Director/D	
B.4670	North	JALANDHAR	11KV	DS Dvsn. Cantt. Jalandhar	DS S/D Rural Cantt. Jalandhar	8551FL06	CRANEVAY	AMR	OK	31.03.2023	Category 1				11114496	900-450/577/1-1	0.024	NA	Director/D	
B.4671	North	JALANDHAR	11KV	DS Dvsn. Cantt. Jalandhar	DS S/D Rural Cantt. Jalandhar	8551FL22	11 KV udhampur	NON AMR	OK	31.03.2023	AP 3Phase 3Wire				3995	900-450/577/1-1	1.441	NA	Director/D	
B.4672	North	JALANDHAR	11KV	DS Dvsn. Cantt. Jalandhar	DS S/D Rural Cantt. Jalandhar	8551FL04	FOLRIWAL	AMR	OK	31.03.2023	AP 3Phase 3Wire				16199461	900-450/577/1-1	1.487	NA	Director/D	
B.4673	North	JALANDHAR	11KV	DS Dvsn. Cantt. Jalandhar	DS S/D Rural Cantt. Jalandhar	8551FL01	HANDVAL	AMR	OK	31.03.2023	AP 3Phase 3Wire				900-450/577/1-1	2.064	NA	Director/D		
B.4674	North	JALANDHAR	11KV	DS Dvsn. Cantt. Jalandhar	DS S/D Rural Cantt. Jalandhar	8551FL03	SANSARPUR	NON AMR	OK	31.03.2023	AP 3Phase 3Wire				11114551	900-450/577/1-1	1.027	NA	Director/D	
B.4675	North	JALANDHAR	11KV	DS Dvsn. Cantt. Jalandhar	DS S/D Rural Cantt. Jalandhar	8551FL15	Railway Station	AMR	OK	31.03.2023	AP 3Phase 3Wire				2068404	900-450/577/1-1	2.081	NA	Director/D	
B.4676	North	JALANDHAR	11KV	DS Dvsn. Cantt. Jalandhar	DS S/D Rural Cantt. Jalandhar	8551FL02	JAGRAL	AMR	OK	31.03.2023	AP 3Phase 3Wire				30241	900-450/577/1-1	2.475	NA	Director/D	
B.4677	North	JALANDHAR	11KV	DS Dvsn. Cantt. Jalandhar	DS S/D Rural Cantt. Jalandhar	8551FL12	bambwal 2	AMR	OK	31.03.2023	AP 3Phase 3Wire				11114560	900-450/577/1-1	2.583	NA	Director/D	
B.4678	North	JALANDHAR	11KV	DS Dvsn. Cantt. Jalandhar	DS S/D Rural Cantt. Jalandhar	8551FL07	HOUSING BOARD	AMR	OK	31.03.2023	Category 1				1111754	900-450/577/1-1	5.369	NA	Director/D	
B.4679	North	JALANDHAR	11KV	DS Dvsn. Cantt. Jalandhar	DS S/D Rural Cantt. Jalandhar	8551FL10	HOUSING BOARD	AMR	OK	31.03.2023	AP 3Phase 3Wire				2067211	900-450/577/1-1	3.754	NA	Director/D	
B.4680	North	JALANDHAR	11KV	DS Dvsn. Cantt. Jalandhar	DS S/D Rural Cantt. Jalandhar	8551FL09	DHANA	AMR	OK	31.03.2023	Category 5-UPS				7338807	900-450/577/1-1	6.939	NA	Director/D	
B.4681	North	JALANDHAR	11KV	DS Dvsn. Cantt. Jalandhar	DS S/D Rural Cantt. Jalandhar	8551FL08	JAMSHER	AMR	OK	31.03.2023	Category 5-UPS				2067025	900-450/577/1-1	11.196	NA	Director/D	
B.4682	North	JALANDHAR	11KV	DS Dvsn. Cantt. Jalandhar	DS S/D Rural Cantt. Jalandhar	8551FL11	BHODE SAPRAI	NON AMR	OK	31.03.202										

S.No	Zone	Circle	Voltage Level (kVA)	Division (kVA)	Sub-Division (kVA)	Feeder ID	Feeder Name	Feeder Metering Status (Metered/unmetered/AMR/AM)	Status of Meter (Functional/Non-functional)	Metering Date	Date of last actual meter working communication	Feeder Type (Agr/Industrial/Mixed)	Status of Communication			Period from 01.04.2021 to 31.03.2022				Sales	Remarks (Source of data)
													% data received through automatically if feeder AMR/AM	Number of hours when meter was unable to communicate in overall	Total Number of hours in the period	Meter S.No	CT/PT ratio	Import (kWh)	Export (kWh)		
B.4723	North	JALANDHAR	11KV	DS Dvsn. Cantt. Jalandhar	DS 5/D Tech-2 Suburban Cantt. Jalandhar	0564FL09	DRDO	NON AMR	OK	31.03.2023		Category 1				12527342	1200-600/5	2.579		NA	Director/D
B.4724	North	JALANDHAR	11KV	DS Dvsn. Cantt. Jalandhar	DS 5/D Tech-2 Suburban Cantt. Jalandhar	0564FL12	Karol bagh	AMR	OK	31.03.2023		Category 1				2563	600/577/1-1-1	6.611		NA	Director/D
B.4725	North	JALANDHAR	11KV	DS Dvsn. Cantt. Jalandhar	DS 5/D Tech-2 Suburban Cantt. Jalandhar	0564FL04	UNIVERSITY	AMR	OK	31.03.2023		Category 1				2047133	1200-600/5	11.751		NA	Director/D
B.4726	North	JALANDHAR	11KV	DS Dvsn. Cantt. Jalandhar	DS 5/D Tech-2 Suburban Cantt. Jalandhar	0564FL10	BASANT HILLS	NON AMR	OK	31.03.2023		Category 1				4813782	600/577/1-1-1	12.352		NA	Director/D
B.4727	North	JALANDHAR	11KV	DS Dvsn. Cantt. Jalandhar	DS 5/D Tech-2 Suburban Cantt. Jalandhar	0564FL11	EKTA MAGAR	AMR	OK	31.03.2023		Category 1				1956049	1200-600/5	14.319		NA	Director/D
B.4728	North	JALANDHAR	11KV	DS Dvsn. Cantt. Jalandhar	DS 5/D Tech-2 Suburban Cantt. Jalandhar	0564FL02	CHOGITTI	NON AMR	OK	31.03.2023		Category 1				6669371	600/577/1-1-1	15.700		NA	Director/D
B.4729	North	JALANDHAR	11KV	DS Dvsn. Cantt. Jalandhar	DS 5/D Tech-2 Suburban Cantt. Jalandhar	0564FL03	LADHAYWALI	AMR	OK	31.03.2023		Category 1				9154355	1200-600/5	17.100		NA	Director/D
B.4730	North	JALANDHAR	11KV	DS Dvsn. Cantt. Jalandhar	DS 5/D Tech-2 Suburban Cantt. Jalandhar	0564FH16	Talhan	AMR	OK	31.03.2023		AP 3Phase 3Wire				778053	600/577/1-1-1	2.200		NA	Director/D
B.4731	North	JALANDHAR	11KV	DS Dvsn. Cantt. Jalandhar	DS 5/D Tech-2 Suburban Cantt. Jalandhar	0564FL07	CHOKAN	AMR	OK	31.03.2023		AP 3Phase 3Wire				2067153	600/577/1-1-1	2.293		NA	Director/D
B.4732	North	JALANDHAR	11KV	DS Dvsn. Cantt. Jalandhar	DS 5/D Tech-2 Suburban Cantt. Jalandhar	0565FL01	BHAKHARANA	NON AMR	OK	31.03.2023		AP 3Phase 3Wire				9148085	600/577/1-1-1	2.387		NA	Director/D
B.4733	North	JALANDHAR	11KV	DS Dvsn. East. Jalandhar	DS 5/D Tech-3 Industrial Area, Jalandhar	0501FL01	SHANKAR	NON AMR	OK	31.03.2023		Category 2				11116900	1200/577/1-1-1	3.167		NA	Director/D
B.4734	North	JALANDHAR	11KV	DS Dvsn. East. Jalandhar	DS 5/D Tech-3 Industrial Area, Jalandhar	0503FL03	GURU NANAK	NON AMR	OK	31.03.2023		Category 2				11116807	1200/577/1-1-1	3.824		NA	Director/D
B.4735	North	JALANDHAR	11KV	DS Dvsn. East. Jalandhar	DS 5/D Tech-3 Industrial Area, Jalandhar	0503FL06	DRAIN	NON AMR	OK	31.03.2023		Category 2				11116901	1200/577/1-1-1	8.597		NA	Director/D
B.4736	North	JALANDHAR	11KV	DS Dvsn. East. Jalandhar	DS 5/D Tech-3 Industrial Area, Jalandhar	0503FL09	VIVEKANAND	NON AMR	OK	31.03.2023		Category 2				11117067	1200/577/1-1-1	8.878		NA	Director/D
B.4737	North	JALANDHAR	11KV	DS Dvsn. East. Jalandhar	DS 5/D Tech-3 Industrial Area, Jalandhar	1202FL02	TOWER	NON AMR	OK	31.03.2023		Category 2				11117000	1200/577/1-1-1	9.517		NA	Director/D
B.4738	North	JALANDHAR	11KV	DS Dvsn. East. Jalandhar	DS 5/D Tech-3 Industrial Area, Jalandhar	1322FL07	RAM VIHAR	NON AMR	OK	31.03.2023		Category 2				11116869	1200/577/1-1-1	9.775		NA	Director/D
B.4739	North	JALANDHAR	11KV	DS Dvsn. East. Jalandhar	DS 5/D Tech-3 Industrial Area, Jalandhar	1323FL10	SATYAM	NON AMR	OK	31.03.2023		Category 2				11116829	1200/577/1-1-1	9.901		NA	Director/D
B.4740	North	JALANDHAR	11KV	DS Dvsn. East. Jalandhar	DS 5/D Tech-3 Industrial Area, Jalandhar	1301FL08	RAJA GARDEN	NON AMR	OK	31.03.2023		Category 2				11116917	1200/577/1-1-1	10.157		NA	Director/D
B.4741	North	JALANDHAR	11KV	DS Dvsn. East. Jalandhar	DS 5/D Tech-3 Industrial Area, Jalandhar	0509FL05	BABA MANDIR 132KV FOCAL POINT	NON AMR	OK	31.03.2023		Category 2				11116728	1200/577/1-1-1	10.293		NA	Director/D
B.4742	North	JALANDHAR	11KV	DS Dvsn. East. Jalandhar	DS 5/D Tech-3 Industrial Area, Jalandhar	A003FL04	Balinderpur road	NON AMR	OK	31.03.2023		Category 2				11116915	1200/577/1-1-1	12.155		NA	Director/D
B.4743	North	JALANDHAR	11KV	DS Dvsn. East. Jalandhar	DS 5/D Tech-3 Industrial Area, Jalandhar	0534FL03	BALLAR	AMR	OK	31.03.2023		Category 5-UPS				9154204	1200/577/1-1-1	14.589		NA	Director/D
B.4744	North	JALANDHAR	11KV	DS Dvsn. East. Jalandhar	DS 5/D Tech-3 Industrial Area, Jalandhar	0573FL12	MOKHE	AMR	OK	31.03.2023		AP 3Phase 3Wire				5464	1200-600/5	1.428		NA	Director/D
B.4745	North	JALANDHAR	11KV	DS Dvsn. East. Jalandhar	DS 5/D Tech-3 Industrial Area, Jalandhar	0573FL10	NANDGA	AMR	OK	31.03.2023		Category 2				5477	1200-600/5	1.545		NA	Director/D
B.4746	North	JALANDHAR	11KV	DS Dvsn. East. Jalandhar	DS 5/D Tech-3 Industrial Area, Jalandhar	0573FL05	D BLOCK	AMR	OK	31.03.2023		Category 2				5510	1200-600/5	5.627		NA	Director/D
B.4747	North	JALANDHAR	11KV	DS Dvsn. East. Jalandhar	DS 5/D Tech-3 Industrial Area, Jalandhar	0573FL13	TUBEWELL CORPORATION	AMR	OK	31.03.2023		Category 2				5497	1200-600/5	5.633		NA	Director/D
B.4748	North	JALANDHAR	11KV	DS Dvsn. East. Jalandhar	DS 5/D Tech-3 Industrial Area, Jalandhar	0573FL07	CO-OP STORE	AMR	OK	31.03.2023		Category 2				5465	1200-600/5	7.395		NA	Director/D
B.4749	North	JALANDHAR	11KV	DS Dvsn. East. Jalandhar	DS 5/D Tech-3 Industrial Area, Jalandhar	0573FL01	SEED CORPORATION	AMR	OK	31.03.2023		Category 2				5471	1200-600/5	7.487		NA	Director/D
B.4750	North	JALANDHAR	11KV	DS Dvsn. East. Jalandhar	DS 5/D Tech-3 Industrial Area, Jalandhar	0573FL03	NEW SHANKAR	AMR	OK	31.03.2023		Category 2				5526	1200-600/5	9.033		NA	Director/D
B.4751	North	JALANDHAR	11KV	DS Dvsn. East. Jalandhar	DS 5/D Tech-3 Industrial Area, Jalandhar	0573FL11	NULCON	AMR	OK	31.03.2023		Category 2				5467	1200-600/5	9.622		NA	Director/D
B.4752	North	JALANDHAR	11KV	DS Dvsn. East. Jalandhar	DS 5/D Tech-3 Industrial Area, Jalandhar	0573FL02	PILOT	AMR	OK	31.03.2023		Category 2				5462	1200-600/5	9.707		NA	Director/D
B.4753	North	JALANDHAR	11KV	DS Dvsn. East. Jalandhar	DS 5/D Tech-3 Industrial Area, Jalandhar	0573FL08	BASANT	AMR	OK	31.03.2023		Category 2				5511	1200-600/5	10.451		NA	Director/D
B.4754	North	JALANDHAR	11KV	DS Dvsn. East. Jalandhar	DS 5/D Tech-3 Industrial Area, Jalandhar	0573FL04	PANIPUR	AMR	OK	31.03.2023		Category 2				5480	1200-600/5	11.855		NA	Director/D
B.4755	North	JALANDHAR	11KV	DS Dvsn. East. Jalandhar	DS 5/D Tech-3 Industrial Area, Jalandhar	0573FL06	GLOBE COLONY	AMR	OK	31.03.2023		Category 2				5527	1200-600/5	11.980		NA	Director/D
B.4756	North	JALANDHAR	11KV	DS Dvsn. East. Jalandhar	DS 5/D Tech-3 Industrial Area, Jalandhar	0573FL09	BEDI	NON AMR	OK	31.03.2023		Category 2				5513	1200-600/5	16.113		NA	Director/D
B.4757	North	JALANDHAR	11KV	DS Dvsn. East. Jalandhar	DS 5/D Tech-3 Industrial Area, Jalandhar	0552FL08	TRANSPORT NAGAR	NON AMR	OK	31.03.2023		Category 2				197956	1200/577/1-1-1	0.000		NA	Director/D
B.4758	North	JALANDHAR	11KV	DS Dvsn. East. Jalandhar	DS 5/D Tech-3 Industrial Area, Jalandhar	0552FL09	UTTAM	NON AMR	OK	31.03.2023		Category 2				197847	1200/577/1-1-1	0.000		NA	Director/D
B.4759	North	JALANDHAR	11KV	DS Dvsn. East. Jalandhar	DS 5/D Tech-3 Industrial Area, Jalandhar	0552FL16	SHIV MANDIR	NON AMR	OK	31.03.2023		Category 2				198054	1200/577/1-1-1	0.000		NA	Director/D
B.4760	North	JALANDHAR	11KV	DS Dvsn. East. Jalandhar	DS 5/D Tech-3 Industrial Area, Jalandhar	0552FL13	11 KV CANAL NO 2	AMR	OK	31.03.2023		Category 2				43229	1200/577/1-1-1	0.000		NA	Director/D
B.4761	North	JALANDHAR	11KV	DS Dvsn. East. Jalandhar	DS 5/D Tech-3 Industrial Area, Jalandhar	0552FL25	NEW FOCAL POINT	NON AMR	OK	31.03.2023		Category 2				43140	1200/577/1-1-1	0.000		NA	Director/D
B.4762	North	JALANDHAR	11KV	DS Dvsn. East. Jalandhar	DS 5/D Tech-3 Industrial Area, Jalandhar	0552FL04	RANDHAWA MASANDA	NON AMR	OK	31.03.2023		AP 3Phase 3Wire				197821	1200/577/1-1-1	2.316		NA	Director/D
B.4763	North	JALANDHAR	11KV	DS Dvsn. East. Jalandhar	DS 5/D Tech-3 Industrial Area, Jalandhar	0552FL21	SHEETAL MILL	NON AMR	OK	31.03.2023		Category 2				12093433	1200/577/1-1-1	4.066		NA	Director/D
B.4764	North	JALANDHAR	11KV	DS Dvsn. East. Jalandhar	DS 5/D Tech-3 Industrial Area, Jalandhar	0552FL29	SUN FLAG	NON AMR	OK	31.03.2023		Category 2				198036	1200/577/1-1-1	4.234		NA	Director/D
B.4765	North	JALANDHAR	11KV	DS Dvsn. East. Jalandhar	DS 5/D Tech-3 Industrial Area, Jalandhar	0552FL16	NEW KANBI	NON AMR	OK	31.03.2023		Category 2				16193935	1200/577/1-1-1	4.827		NA	Director/D
B.4766	North	JALANDHAR	11KV	DS Dvsn. East. Jalandhar	DS 5/D Tech-3 Industrial Area, Jalandhar	0552FL13	INDUSTRIAL-3	NON AMR	OK	31.03.2023		Category 2				198064	1200/577/1-1-1	7.061		NA	Director/D
B.4767	North	JALANDHAR	11KV	DS Dvsn. East. Jalandhar	DS 5/D Tech-3 Industrial Area, Jalandhar	0552FL20	JAGDAMBA FEEDER	NON AMR	OK	31.03.2023		Category 2				9153623	1200/577/1-1-1	7.168		NA	Director/D
B.4768	North	JALANDHAR	11KV	DS Dvsn. East. Jalandhar	DS 5/D Tech-3 Industrial Area, Jalandhar	0552FL13	WATER SUPPLY	NON AMR	OK	31.03.2023		Category 2				198061	1200/577/1-1-1	7.572		NA	Director/D
B.4769	North	JALANDHAR	11KV	DS Dvsn. East. Jalandhar	DS 5/D Tech-3 Industrial Area, Jalandhar	0552FL12	JUDOG NAGAR	NON AMR	OK	31.03.2023		Category 2				198077	1200/577/1-1-1	7.874		NA	Director/D
B.4770	North	JALANDHAR	11KV	DS Dvsn. East. Jalandhar	DS 5/D Tech-3 Industrial Area, Jalandhar	0552FL14	CANAL	AMR	OK	31.03.2023		Category 2				198052	1200/577/1-1-1	7.967		NA	Director/D
B.4771	North	JALANDHAR	11KV	DS Dvsn. East. Jalandhar	DS 5/D Tech-3 Industrial Area, Jalandhar	0552FL14	GURU AMAR DASS NAGAR	AMR	OK	31.03.2023		Category 2				9153623	1200/577/1-1-1	8.008		NA	Director/D
B.4772	North	JALANDHAR	11KV	DS Dvsn. East. Jalandhar	DS 5/D Tech-3 Industrial Area, Jalandhar	0552FL24	KALIA COLONY	AMR	OK	31.03.2023		Category 1				33692	1200/577/1-1-1	8.291		NA	Director/D
B.4773	North	JALANDHAR	11KV	DS Dvsn. East. Jalandhar	DS 5/D Tech-3 Industrial Area, Jalandhar	0552FL22	GADAI PUR - 2	NON AMR	OK	31.03.2023		Category 2				9154085	1200/577/1-1-1	8.770		NA	Director/D
B.4774	North	JALANDHAR	11KV	DS Dvsn. East. Jalandhar	DS 5/D Tech-3 Industrial Area, Jalandhar	0552FL05	DIC 2	NON AMR	OK	31.03.2023		Category 2				197960	1200/577/1-1-1	9.326		NA	Director/D
B.4775	North	JALANDHAR	11KV	DS Dvsn. East. Jalandhar	DS 5/D Tech-3 Industrial Area, Jalandhar	0552FL02	D.I.C. - 1	NON AMR	OK	31.03.2023		Category 2				197949	1200/577/1-1-1	10.545		NA	Director/D
B.4776	North	JALANDHAR	11KV	DS Dvsn. East. Jalandhar	DS 5/D Tech-3 Industrial Area, Jalandhar	0552FL06	BABA VISHAKARMA MANDIR	NON AMR	OK	31.03.2023		Category 2				198046	1200/577/1-1-1	11.647		NA	Director/D
B.4777	North	JALANDHAR	11KV	DS Dvsn. East. Jalandhar	DS 5/D Tech-3 Industrial Area, Jalandhar	0552FL19	B.S.N.L	NON AMR	OK	31.03.2023		Category 2				198040	1200/577/1-1-1	13.175		NA	Director/D
B.4778	North	JALANDHAR	11KV	DS Dvsn. East. Jalandhar	DS 5/D Tech-3 Industrial Area, Jalandhar	0552FL15	GLDAPUR	NON AMR	OK	31.03.2023		Category 2				11051978	1200/577/1-1-1	14.144		NA	Director/D
B.4779	North	JALANDHAR	11KV	DS Dvsn. East. Jalandhar	DS 5/D Tech-3 Industrial Area, Jalandhar	0552FL28	FAZIL PUR	AMR	OK	31.03.2023		Category 2				2703	1200/577/1-1-1	14.452		NA	Director/D
B.4780	North	JALANDHAR	11KV	DS Dvsn. East. Jalandhar	DS 5/D Tech-3 Industrial Area, Jalandhar	0552FL18	FOCAL POINT 2	AMR	OK	31.03.2023		Category 3				9153587	1200/577/1-1-1	14.536		NA	Director/D
B.4781	North	JALANDHAR	11KV	DS Dvsn. East. Jalandhar	DS 5/D Tech-3 Industrial Area, Jalandhar	0552FL01	INDUSTRIAL AREA 2	NON AMR	OK	31.03.2023		Category 2				9154011	1200/577/1-1-1	15.366		NA	Director/D
B.4782	North	JALANDHAR	11KV	DS Dvsn. East. Jalandhar	DS 5/D Tech-3 Industrial Area, Jalandhar	0552FL06	GURUDWARA SH														

S.No	Zone	Circle	Voltage Level (kVA)	Division (kVA)	Sub-Division (kVA)	Feeder ID	Feeder Name	Feeder Metering Status (Metered/unmetered/AMR/AM)	Status of Meter (Functional/Non-Functional)	Metering Date	Date of last actual meter working communication	Feeder Type (Agr/Industrial/Mixed)	Status of Communication			Period from 01.04.2021 to 31.03.2022				Sales	Remarks (Source of data)
													% data received through automatically if feeder AMR/AM	Number of hours when meter was unable to communicate in period	Total Number of hours in the period	Meter S.No	CT/PT ratio	Import (kWh)	Export (kWh)		
B.4820	North	JALANDHAR	11KV	DS Divn. East, Jalandhar	DS S/D Tech-1 Nehru Garden, Jalandhar	D5S1F126	Pruthi Hospital	AMR	OK	31.03.2023		Category 1				2068282	600/577/1-1-1	4.958	NA	Director/D	
B.4821	North	JALANDHAR	11KV	DS Divn. East, Jalandhar	DS S/D Tech-1 Nehru Garden, Jalandhar	D5S1F108	OLU ESTATE	AMR	OK	31.03.2023		Category 2				4189717	600/577/1-1-1	5.111	NA	Director/D	
B.4822	North	JALANDHAR	11KV	DS Divn. East, Jalandhar	DS S/D Tech-1 Nehru Garden, Jalandhar	D5S1F123	Hargobind Nagar	AMR	OK	31.03.2023		Category 2				11117394	600/577/1-1-1	6.092	NA	Director/D	
B.4823	North	JALANDHAR	11KV	DS Divn. East, Jalandhar	DS S/D Tech-1 Nehru Garden, Jalandhar	D5S1F113	NEW ESTATE	AMR	OK	31.03.2023		Category 2				2068601	600/577/1-1-1	6.288	NA	Director/D	
B.4824	North	JALANDHAR	11KV	DS Divn. East, Jalandhar	DS S/D Tech-1 Nehru Garden, Jalandhar	D5S1F131	11 KV NEW SHARP CHUCK	NON AMR	OK	31.03.2023		Category 2				5515	600/577/1-1-1	6.492	NA	Director/D	
B.4825	North	JALANDHAR	11KV	DS Divn. East, Jalandhar	DS S/D Tech-1 Nehru Garden, Jalandhar	D5S1F129	STATE BANK FEEDER	AMR	OK	31.03.2023		Category 2				17316268	600/577/1-1-1	7.794	NA	Director/D	
B.4826	North	JALANDHAR	11KV	DS Divn. East, Jalandhar	DS S/D Tech-1 Nehru Garden, Jalandhar	D5S1F111	KMV	AMR	OK	31.03.2023		Category 2				2067243	600/577/1-1-1	8.005	NA	Director/D	
B.4827	North	JALANDHAR	11KV	DS Divn. East, Jalandhar	DS S/D Tech-1 Nehru Garden, Jalandhar	D5S1F117	GALUSHALLA	AMR	OK	31.03.2023		Category 2				2068320	600/577/1-1-1	8.263	NA	Director/D	
B.4828	North	JALANDHAR	11KV	DS Divn. East, Jalandhar	DS S/D Tech-1 Nehru Garden, Jalandhar	D5S1F103	SAROOH NAGAR	AMR	OK	31.03.2023		Category 2				15190683	600/577/1-1-1	8.296	NA	Director/D	
B.4829	North	JALANDHAR	11KV	DS Divn. East, Jalandhar	DS S/D Tech-1 Nehru Garden, Jalandhar	D5S1F132	11 KV SHIV MANDIR	AMR	OK	31.03.2023		Category 2				5521	600/577/1-1-1	9.074	NA	Director/D	
B.4830	North	JALANDHAR	11KV	DS Divn. East, Jalandhar	DS S/D Tech-1 Nehru Garden, Jalandhar	D5S1F101	G.T.ROAD	AMR	OK	31.03.2023		Category 2				2066592	600/577/1-1-1	9.395	NA	Director/D	
B.4831	North	JALANDHAR	11KV	DS Divn. East, Jalandhar	DS S/D Tech-1 Nehru Garden, Jalandhar	D5S1F119	TRIBUNE	AMR	OK	31.03.2023		Category 2				5437515	600/577/1-1-1	10.611	NA	Director/D	
B.4832	North	JALANDHAR	11KV	DS Divn. East, Jalandhar	DS S/D Tech-1 Nehru Garden, Jalandhar	D5S1F127	Baba Deep Singh Nagar	AMR	OK	31.03.2023		Category 1				5342144	600/577/1-1-1	10.621	NA	Director/D	
B.4833	North	JALANDHAR	11KV	DS Divn. East, Jalandhar	DS S/D Tech-1 Nehru Garden, Jalandhar	D5S1F116	KALU MATA MANDIR	AMR	OK	31.03.2023		Category 2				12092503	600/577/1-1-1	10.912	NA	Director/D	
B.4834	North	JALANDHAR	11KV	DS Divn. East, Jalandhar	DS S/D Tech-1 Nehru Garden, Jalandhar	D5S1F118	REERU	AMR	OK	31.03.2023		Category 1				2066315	600/577/1-1-1	10.971	NA	Director/D	
B.4835	North	JALANDHAR	11KV	DS Divn. East, Jalandhar	DS S/D Tech-1 Nehru Garden, Jalandhar	D5S1F128	Hoshigarh Road	AMR	OK	31.03.2023		Category 1				2066570	600/577/1-1-1	11.069	NA	Director/D	
B.4836	North	JALANDHAR	11KV	DS Divn. East, Jalandhar	DS S/D Tech-1 Nehru Garden, Jalandhar	D5S1F121	Khalsa Road	AMR	OK	31.03.2023		Category 2				12093508	600/577/1-1-1	12.253	NA	Director/D	
B.4837	North	JALANDHAR	11KV	DS Divn. East, Jalandhar	DS S/D Tech-1 Nehru Garden, Jalandhar	D5S1F120	SHARP CHUCK	AMR	OK	31.03.2023		Category 2				12092468	600/577/1-1-1	12.414	NA	Director/D	
B.4838	North	JALANDHAR	11KV	DS Divn. East, Jalandhar	DS S/D Tech-1 Nehru Garden, Jalandhar	D5S1F110	KOTLA ROAD	NON AMR	OK	31.03.2023		Category 2				12093442	600/577/1-1-1	14.498	NA	Director/D	
B.4839	North	JALANDHAR	11KV	DS Divn. East, Jalandhar	DS S/D Tech-1 Nehru Garden, Jalandhar	D5S1F122	Chara Mandi	AMR	OK	31.03.2023		Category 2				12479720	600/577/1-1-1	15.265	NA	Director/D	
B.4840	North	JALANDHAR	11KV	DS Divn. East, Jalandhar	DS S/D Tech-1 Nehru Garden, Jalandhar	D5S1F112	CHAK HUSSIANA	AMR	OK	31.03.2023		Category 1				12025457	600/577/1-1-1	17.391	NA	Director/D	
B.4841	North	JALANDHAR	11KV	DS Divn. East, Jalandhar	DS S/D Tech-1 Nehru Garden, Jalandhar	D5S1F105	SODAL	AMR	OK	31.03.2023		Category 1				2066748	600/577/1-1-1	18.351	NA	Director/D	
B.4842	North	JALANDHAR	11KV	DS Divn. East, Jalandhar	DS S/D Tech-2 Nehru Garden, Jalandhar	C5S5F112	NEHRU GARDEN ROAD	AMR	OK	31.03.2023		Category 1				9153582	1200/577/1-1-1	15.291	NA	Director/D	
B.4843	North	JALANDHAR	11KV	DS Divn. East, Jalandhar	DS S/D Tech-2 Nehru Garden, Jalandhar	D5S6F113	URBAN ESTATE	NON AMR	OK	31.03.2023		Category 1				2067914	1200/577/1-1-1	1.964	NA	Director/D	
B.4844	North	JALANDHAR	11KV	DS Divn. East, Jalandhar	DS S/D Tech-2 Nehru Garden, Jalandhar	D5S6F121	Railway Road	AMR	OK	31.03.2023		Category 1				581752	900-450/577/1-1-1	4.335	NA	Director/D	
B.4845	North	JALANDHAR	11KV	DS Divn. East, Jalandhar	DS S/D Tech-2 Nehru Garden, Jalandhar	D5S6F119	INDIAN OIL	AMR	OK	31.03.2023		Category 3				660725	1200/577/1-1-1	4.873	NA	Director/D	
B.4846	North	JALANDHAR	11KV	DS Divn. East, Jalandhar	DS S/D Tech-2 Nehru Garden, Jalandhar	D5S6F106	DAKHOA	AMR	OK	31.03.2023		Category 1				6769901	600/577/1-1-1	5.501	NA	Director/D	
B.4847	North	JALANDHAR	11KV	DS Divn. East, Jalandhar	DS S/D Tech-2 Nehru Garden, Jalandhar	D5S6F114	DEFENCE COLONY	AMR	OK	31.03.2023		Category 1				7365888	600/577/1-1-1	6.082	NA	Director/D	
B.4848	North	JALANDHAR	11KV	DS Divn. East, Jalandhar	DS S/D Tech-2 Nehru Garden, Jalandhar	D5S6F110	GURU GOBIND SINGH AVENUE	AMR	OK	31.03.2023		Category 1				6607232	1200/577/1-1-1	9.030	NA	Director/D	
B.4849	North	JALANDHAR	11KV	DS Divn. East, Jalandhar	DS S/D Tech-2 Nehru Garden, Jalandhar	D5S6F102	CENTRAL MILL	AMR	OK	31.03.2023		Category 1				5437746	600/577/1-1-1	10.475	NA	Director/D	
B.4850	North	JALANDHAR	11KV	DS Divn. East, Jalandhar	DS S/D Tech-2 Nehru Garden, Jalandhar	D5S6F112	MANDI ROAD	AMR	OK	31.03.2023		Category 1				10262877	1200/577/1-1-1	11.332	NA	Director/D	
B.4851	North	JALANDHAR	11KV	DS Divn. East, Jalandhar	DS S/D Tech-2 Nehru Garden, Jalandhar	D5S6F109	ARJUN NAGAR	AMR	OK	31.03.2023		Category 1				2066878	600/577/1-1-1	14.883	NA	Director/D	
B.4852	North	JALANDHAR	11KV	DS Divn. East, Jalandhar	DS S/D Tech-2 Nehru Garden, Jalandhar	D5S6F108	BYE PASS	AMR	OK	31.03.2023		Category 1				2066916	1200/577/1-1-1	16.887	NA	Director/D	
B.4853	North	JALANDHAR	11KV	DS Divn. Model Town,	JDS S/D S/U Lambran,Jalandhar	D5S5F113	BASANT VIHAR	AMR	OK	31.03.2023		Category 1				2068154	1200-600/5	0.707	NA	Director/D	
B.4854	North	JALANDHAR	11KV	DS Divn. Model Town,	JDS S/D S/U Lambran,Jalandhar	D5S5F118	T. V. TOWER	NON AMR	OK	31.03.2023		Category 4				20671040	1200-600/5	0.883	NA	Director/D	
B.4855	North	JALANDHAR	11KV	DS Divn. Model Town,	JDS S/D S/U Lambran,Jalandhar	D5S5F115	MALKO	AMR	OK	31.03.2023		AP 3Phase 3Wire				73162804	1200-600/5	1.965	NA	Director/D	
B.4856	North	JALANDHAR	11KV	DS Divn. Model Town,	JDS S/D S/U Lambran,Jalandhar	D5S5F116	NANAKSAR	NON AMR	OK	31.03.2023		Category 2				12021161	1200-600/5	3.867	NA	Director/D	
B.4857	North	JALANDHAR	11KV	DS Divn. Model Town,	JDS S/D S/U Lambran,Jalandhar	D5S5F117	LOHANAR	NON AMR	OK	31.03.2023		AP 3Phase 3Wire				73162742	1200-600/5	2.471	NA	Director/D	
B.4858	North	JALANDHAR	11KV	DS Divn. Model Town,	JDS S/D S/U Lambran,Jalandhar	D5S5F107	CHITTI (R)	AMR	OK	31.03.2023		AP 3Phase 3Wire				73163090	1200-600/5	2.555	NA	Director/D	
B.4859	North	JALANDHAR	11KV	DS Divn. Model Town,	JDS S/D S/U Lambran,Jalandhar	D5S5F105	KHURLA KINGRA	NON AMR	OK	31.03.2023		Category 1				6761977	1200-600/5	2.816	NA	Director/D	
B.4860	North	JALANDHAR	11KV	DS Divn. Model Town,	JDS S/D S/U Lambran,Jalandhar	D5S5F101	KANG SABOO	NON AMR	OK	31.03.2023		AP 3Phase 3Wire				73163103	1200-600/5	2.889	NA	Director/D	
B.4861	North	JALANDHAR	11KV	DS Divn. Model Town,	JDS S/D S/U Lambran,Jalandhar	D5L1D555	LIDHPUR	NON AMR	OK	31.03.2023		AP 3Phase 3Wire				16198444	1200-600/5	2.995	NA	Director/D	
B.4862	North	JALANDHAR	11KV	DS Divn. Model Town,	JDS S/D S/U Lambran,Jalandhar	D5S5F112	NIL	AMR	OK	31.03.2023		AP 3Phase 3Wire				73163100	1200-600/5	3.188	NA	Director/D	
B.4863	North	JALANDHAR	11KV	DS Divn. Model Town,	JDS S/D S/U Lambran,Jalandhar	D5S5F114	GADDO WALI	AMR	OK	31.03.2023		Category 5-U/PS				6484009	1200-600/5	4.427	NA	Director/D	
B.4864	North	JALANDHAR	11KV	DS Divn. Model Town,	JDS S/D S/U Lambran,Jalandhar	D5S5F103	MAAN NAGAR	AMR	OK	31.03.2023		Category 1				2068226	1200-600/5	5.170	NA	Director/D	
B.4865	North	JALANDHAR	11KV	DS Divn. Model Town,	JDS S/D S/U Lambran,Jalandhar	D5S5F119	LAMBRA	AMR	OK	31.03.2023		Category 5-U/PS				2067886	1200-600/5	6.276	NA	Director/D	
B.4866	North	JALANDHAR	11KV	DS Divn. Model Town,	JDS S/D S/U Lambran,Jalandhar	D5S5F109	TOWER ENCLAVE	NON AMR	OK	31.03.2023		Category 1				14167939	1200-600/5	6.884	NA	Director/D	
B.4867	North	JALANDHAR	11KV	DS Divn. Model Town,	JDS S/D S/U Lambran,Jalandhar	D5S5F121	BAJANLAN	AMR	OK	31.03.2023		Category 5-U/PS				12024441	1200-600/5	7.028	NA	Director/D	
B.4868	North	JALANDHAR	11KV	DS Divn. Model Town,	JDS S/D S/U Lambran,Jalandhar	D5S5F104	GILL COLONY	NON AMR	OK	31.03.2023		Category 5-U/PS				4231032	1200-600/5	13.706	NA	Director/D	
B.4869	North	JALANDHAR	11KV	DS Divn. Model Town,	JDS S/D S/U Lambran,Jalandhar	D5S7F110	BOMBAY NAGAR	AMR	OK	31.03.2023		Category 1				7336813	1200/577/1-1-1	9.346	NA	Director/D	
B.4870	North	JALANDHAR	11KV	DS Divn. Model Town,	JDS S/D S/U Lambran,Jalandhar	D5S7F112	DEOL NAGAR	AMR	OK	31.03.2023		Category 1				33693	1200/577/1-1-1	12.187	NA	Director/D	
B.4871	North	JALANDHAR	11KV	DS Divn. Model Town,	JDS S/D S/U Lambran,Jalandhar	D5S8F115	CHAK YENDAL	AMR	OK	31.03.2023		Category 4				43194	600/577/1-1-1	0.373	NA	Director/D	
B.4872	North	JALANDHAR	11KV	DS Divn. Model Town,	JDS S/D S/U Lambran,Jalandhar	D5S8F123	KALIANPUR	AMR	OK	31.03.2023		AP 3Phase 3Wire				1009770	600/577/1-1-1	1.721	NA	Director/D	
B.4873	North	JALANDHAR	11KV	DS Divn. Model Town,	JDS S/D S/U Lambran,Jalandhar	D5S8F120	RAJANPUR	AMR	OK	31.03.2023		AP 3Phase 3Wire				534298	900-450/577/1-1-1	2.841	NA	Director/D	
B.4874	North	JALANDHAR	11KV	DS Divn. Model Town,	JDS S/D S/U Lambran,Jalandhar	D5S8F101	RASULPUR	AMR	OK	31.03.2023		AP 3Phase 3Wire				34110	900-450/577/1-1-1	2.391	NA	Director/D	
B.4875	North	JALANDHAR	11KV	DS Divn. Model Town,	JDS S/D S/U Lambran,Jalandhar	D5S8F116	KHUN-KHUN	AMR	OK	31.03.2023		AP 3Phase 3Wire				2068350	600/577/1-1-1	2.562	NA	Director/D	
B.4876	North	JALANDHAR	11KV	DS Divn. Model Town,	JDS S/D S/U Lambran,Jalandhar	D5S8F105	CHITTI (U)	AMR	OK	31.03.2023		Category 5-U/PS				9154443	900-450/577/1-1-1	2.947	NA	Director/D	
B.4877	North	JALANDHAR	11KV	DS Divn. Model Town,	JDS S/D S/U Lambran,Jalandhar	D5S8F103	SEHAM	AMR	OK	31.03.2023		AP 3Phase 3Wire				11116716	600/577/1-1-1	2.987	NA	Director/D	
B.4878	North	JALANDHAR	11KV	DS Divn. Model Town,	JDS S/D S/U Lambran,Jalandhar	D5S8F106	RAMPUR	AMR	OK	31.03.2023		AP 3Phase 3Wire				3166975	600/577/1-1-1	3.025	NA	Director/D	
B.4879	North	JALANDHAR	11KV	DS Divn. Model Town,	JDS S/D S/U Lambran,Jalandhar	D5S8F109	SINGHA BARANI	AMR	OK	31.03.2023		AP 3Phase 3Wire				2068438	600/577/1-1-1	3.209	NA	Director/D	
B.4880	North	JALANDHAR	11KV	DS Divn. Model Town,	JDS S/D S/U Lambran,Jalandhar	D5S8F114	HUSSANPUR	AMR	OK	31.03.2023		Category 5-U/PS				8223030	600/577/1-1-1	3.254	NA	Director/D	
B.4881	North	JALANDHAR	11KV	DS Divn. Model Town,	JDS S/D S/U Lambran,Jalandhar	D5S8F121	LADHEWALI	AMR	OK	31.03.2023											

S.No	Zone	Circle	Voltage Level (kVA)	Division (kVA)	Sub-Division (kVA)	Feeder ID	Feeder Name	Feeder Metering Status (Metered/unmetered/AMR/AMI)	Status of Meter (Functional/Non-Functional)	Metering Date (Date of last actual meter working/communication)	Feeder Type (Agr/Industrial/Mixed)	Status of Communication			Period from 01.04.2021 to 31.03.2022		Sales	Remarks (Source of data)	
												% data received through automatically if feeder AMR/AMI	Number of hours when meter was unable to communicate in period	Total Number of hours in the period	Meter S.No	CT/PT ratio			Import (kWh)
B.4917	North	JALANDHAR	11kV	DS Divn. Model Town,	DS S/D Tech-2 Model Town, Jalandhar	D555FL09	COLD STORE	AMR	OK	31.03.2023	Category 1				2067722	1200-600/5	6.467	NA	Director/D
B.4918	North	JALANDHAR	11kV	DS Divn. Model Town,	DS S/D Tech-2 Model Town, Jalandhar	D555FL08	NAGAL PURDAL	AMR	OK	31.03.2023	Category 5-UPS				686419	1200-600/5	10.779	NA	Director/D
B.4919	North	JALANDHAR	11kV	DS Divn. Model Town,	DS S/D Tech-2 Model Town, Jalandhar	D555FL05	CHEEMA NAGAR	NON AMR	OK	31.03.2023	Category 1				30260	900-450/577/1-1	6.373	NA	Director/D
B.4920	North	JALANDHAR	11kV	DS Divn. Model Town,	DS S/D Tech-2 Model Town, Jalandhar	D555FL04	11 KV Curd Mail	NON AMR	OK	31.03.2023	Category 1				526498	1200/577/1-1	2.493	NA	Director/D
B.4921	North	JALANDHAR	11kV	DS Divn. Model Town,	DS S/D Tech-2 Model Town, Jalandhar	D555FL02	11KV Royal Residency	NON AMR	OK	31.03.2023	Category 1				526432	1200/577/1-1	3.687	NA	Director/D
B.4922	North	JALANDHAR	11kV	DS Divn. Model Town,	DS S/D Tech-2 Model Town, Jalandhar	D555FL05	MOTA SINGH NAGAR	AMR	OK	31.03.2023	Category 1				583735	1200/577/1-1	5.383	NA	Director/D
B.4923	North	JALANDHAR	11kV	DS Divn. Model Town,	DS S/D Tech-2 Model Town, Jalandhar	D555FL08	11 KV Jalandhar Height-1	AMR	OK	31.03.2023	Category 1				526400	1200/577/1-1	5.774	NA	Director/D
B.4924	North	JALANDHAR	11kV	DS Divn. Model Town,	DS S/D Tech-2 Model Town, Jalandhar	D555FL09	11 KV Garden Colony	NON AMR	OK	31.03.2023	Category 1				526419	1200/577/1-1	6.870	NA	Director/D
B.4925	North	JALANDHAR	11kV	DS Divn. Model Town,	DS S/D Tech-2 Model Town, Jalandhar	D555FL07	11KV Minipur Feeder	NON AMR	OK	31.03.2023	Category 1				526411	1200/577/1-1	13.075	NA	Director/D
B.4926	North	JALANDHAR	11kV	DS Divn. Model Town,	DS S/D Tech-2 Model Town, Jalandhar	D555FL01	11KV Baba Makhan Shah Lubana	NON AMR	OK	31.03.2023	Category 1				16199605	1200/577/1-1	13.300	NA	Director/D
B.4927	North	JALANDHAR	11kV	DS Divn. Model Town,	DS S/D Tech-2 Model Town, Jalandhar	D555FL11	11KV Third Hospiat	NON AMR	OK	31.03.2023	Category 1				23233	1200/577/1-1	0.000	NA	Director/D
B.4928	North	JALANDHAR	11kV	DS Divn. Model Town,	DS S/D Tech-2 Model Town, Jalandhar	D555FL18	Sudhama Vihar	NON AMR	OK	31.03.2023	Category 1				23428	1200/577/1-1	4.007	NA	Director/D
B.4929	North	JALANDHAR	11kV	DS Divn. Model Town,	DS S/D Tech-2 Model Town, Jalandhar	D555FL11	MODEL TOWN	NON AMR	OK	31.03.2023	Category 1				33693	1200/577/1-1	5.118	NA	Director/D
B.4930	North	JALANDHAR	11kV	DS Divn. Model Town,	DS S/D Tech-2 Model Town, Jalandhar	D555FL08	11KV S A S NAGAR	NON AMR	OK	31.03.2023	Category 1				33694	1200/577/1-1	8.398	NA	Director/D
B.4931	North	JALANDHAR	11kV	DS Divn. Model Town,	DS S/D Tech-2 Model Town, Jalandhar	D555FL07	11KV CTR NAGAR	AMR	OK	31.03.2023	Category 1				33695	1200/577/1-1	9.964	NA	Director/D
B.4932	North	JALANDHAR	11kV	DS Divn. Model Town,	DS S/D Tech-3 Abadpura, Jalandhar	C555FL08	LAPAT NAGAR	AMR	OK	31.03.2023	Category 1				9154033	1200/577/1-1	4.951	NA	Director/D
B.4933	North	JALANDHAR	11kV	DS Divn. Model Town,	DS S/D Tech-3 Abadpura, Jalandhar	C555FL14	UDHAM SINGH NAGAR	NON AMR	OK	31.03.2023	Category 1				9153590	1200/577/1-1	12.905	NA	Director/D
B.4934	North	JALANDHAR	11kV	DS Divn. Model Town,	DS S/D Tech-3 Abadpura, Jalandhar	C555FL14	Dushara Ground	NON AMR	OK	31.03.2023	Category 1				983754	1200/577/1-1	2.266	NA	Director/D
B.4935	North	JALANDHAR	11kV	DS Divn. Model Town,	DS S/D Tech-3 Abadpura, Jalandhar	D555FL04	BHARO CAMP	NON AMR	OK	31.03.2023	Category 1				7336865	1200/577/1-1	7.162	NA	Director/D
B.4936	North	JALANDHAR	11kV	DS Divn. Model Town,	DS S/D Tech-3 Abadpura, Jalandhar	D555FL15	Visharma Mandir	NON AMR	OK	31.03.2023	Category 1				733696	1200/577/1-1	8.331	NA	Director/D
B.4937	North	JALANDHAR	11kV	DS Divn. Model Town,	DS S/D Tech-3 Abadpura, Jalandhar	D555FL05	NAXODER ROAD	NON AMR	OK	31.03.2023	Category 1				7341749	1200/577/1-1	8.947	NA	Director/D
B.4938	North	JALANDHAR	11kV	DS Divn. Model Town,	DS S/D Tech-3 Abadpura, Jalandhar	D555FL16	Ravidas Bhavan	NON AMR	OK	31.03.2023	Category 1				33716	1200/577/1-1	10.036	NA	Director/D
B.4939	North	JALANDHAR	11kV	DS Divn. Model Town,	DS S/D Tech-3 Abadpura, Jalandhar	D555FL03	RAPUT NAGAR	NON AMR	OK	31.03.2023	Category 2				7336844	1200/577/1-1	10.674	NA	Director/D
B.4940	North	JALANDHAR	11kV	DS Divn. Model Town,	DS S/D Tech-3 Abadpura, Jalandhar	D555FL01	MODEL HOUSE	NON AMR	OK	31.03.2023	Category 1				7336826	1200/577/1-1	12.687	NA	Director/D
B.4941	North	JALANDHAR	11kV	DS Divn. Model Town,	DS S/D Tech-3 Abadpura, Jalandhar	D555FL06	PRUTHI	NON AMR	OK	31.03.2023	Category 4				5342498	1200-600/5	0.583	NA	Director/D
B.4942	North	JALANDHAR	11kV	DS Divn. Model Town,	DS S/D Tech-3 Abadpura, Jalandhar	D555FL05	LINK ROAD	AMR	OK	31.03.2023	Category 2				6207233	1200-600/5	6.874	NA	Director/D
B.4943	North	JALANDHAR	11kV	DS Divn. Model Town,	DS S/D Tech-4 Bastian, Jalandhar	C607FL06	CHAMARA	AMR	OK	31.03.2023	AP Phase 3Wire				111117012	1200/577/1-1	2.002	NA	Director/D
B.4944	North	JALANDHAR	11kV	DS Divn. Model Town,	DS S/D Tech-4 Bastian, Jalandhar	C607FL13	Firoz	NON AMR	OK	31.03.2023	AP Phase 3Wire				1	1200/577/1-1	2.264	NA	Director/D
B.4945	North	JALANDHAR	11kV	DS Divn. Model Town,	DS S/D Tech-4 Bastian, Jalandhar	D011FL03	MARKETER	NON AMR	OK	31.03.2023	Category 2				526417	1200-600/5	6.981	NA	Director/D
B.4946	North	JALANDHAR	11kV	DS Divn. Model Town,	DS S/D Tech-4 Bastian, Jalandhar	D011FL01	11KV BASTI GUJAN	NON AMR	OK	31.03.2023	Category 1				526411	1200-600/5	10.454	NA	Director/D
B.4947	North	JALANDHAR	11kV	DS Divn. Model Town,	DS S/D Tech-4 Bastian, Jalandhar	D011FL02	JUKKA ESTATE	NON AMR	OK	31.03.2023	Category 1				526409	1200-800/5	10.823	NA	Director/D
B.4948	North	JALANDHAR	11kV	DS Divn. Model Town,	DS S/D Tech-4 Bastian, Jalandhar	D011FL05	11 KV GROVER COLONY	NON AMR	OK	31.03.2023	Category 1				526401	1200-600/5	10.852	NA	Director/D
B.4949	North	JALANDHAR	11kV	DS Divn. Model Town,	DS S/D Tech-4 Bastian, Jalandhar	D011FL04	BASTI DANDS/MANDA	NON AMR	OK	31.03.2023	Category 1				526407	1200-600/5	11.134	NA	Director/D
B.4950	North	JALANDHAR	11kV	DS Divn. Model Town,	DS S/D Tech-4 Bastian, Jalandhar	D017D711	PERFECT BELTING	NON AMR	OK	31.03.2023	Category 4				525507	1200-600/5	2.211	NA	Director/D
B.4951	North	JALANDHAR	11kV	DS Divn. Model Town,	DS S/D Tech-4 Bastian, Jalandhar	D017FL05	RAGHU EXPORT	AMR	OK	31.03.2023	Category 2				525506	1200-600/5	4.980	NA	Director/D
B.4952	North	JALANDHAR	11kV	DS Divn. Model Town,	DS S/D Tech-4 Bastian, Jalandhar	F1360712	Gupta Feeder	NON AMR	OK	31.03.2023	Category 2				5500	1200-600/5	6.233	NA	Director/D
B.4953	North	JALANDHAR	11kV	DS Divn. Model Town,	DS S/D Tech-4 Bastian, Jalandhar	D017FL03	NEW WARYANA COMPLEX NO. 1	AMR	OK	31.03.2023	Category 2				5502	1200-600/5	6.963	NA	Director/D
B.4954	North	JALANDHAR	11kV	DS Divn. Model Town,	DS S/D Tech-4 Bastian, Jalandhar	D017FL12	DOABA FEEDER	AMR	OK	31.03.2023	Category 2				5502	1200-600/5	6.963	NA	Director/D
B.4955	North	JALANDHAR	11kV	DS Divn. Model Town,	DS S/D Tech-4 Bastian, Jalandhar	D017FL11	KARTAR VALVES	NON AMR	OK	31.03.2023	Category 2				5519	1200-600/5	9.427	NA	Director/D
B.4956	North	JALANDHAR	11kV	DS Divn. Model Town,	DS S/D Tech-4 Bastian, Jalandhar	D017FL08	Mahajan Feeder	AMR	OK	31.03.2023	Category 2				525518	1200-600/5	9.561	NA	Director/D
B.4957	North	JALANDHAR	11kV	DS Divn. Model Town,	DS S/D Tech-4 Bastian, Jalandhar	D017FL10	11KV JUNEJA FORGING	NON AMR	OK	31.03.2023	Category 2				5524	1200-600/5	11.808	NA	Director/D
B.4958	North	JALANDHAR	11kV	DS Divn. Model Town,	DS S/D Tech-4 Bastian, Jalandhar	D555FL16	BASTI SHIKH	NON AMR	OK	31.03.2023	Category 1				33013	1200-800/5	6.158	NA	Director/D
B.4959	North	JALANDHAR	11kV	DS Divn. Model Town,	DS S/D Tech-4 Bastian, Jalandhar	D555FL11	Sanjali Sohail	NON AMR	OK	31.03.2023	AP Phase 3Wire				15199572	1200/577/1-1	15.347	NA	Director/D
B.4960	North	JALANDHAR	11kV	DS Divn. Model Town,	DS S/D Tech-4 Bastian, Jalandhar	D555FL16	JALANDHAR KUNI	AMR	OK	31.03.2023	Category 1				2067393	1200/577/1-1	4.499	NA	Director/D
B.4961	North	JALANDHAR	11kV	DS Divn. Model Town,	DS S/D Tech-4 Bastian, Jalandhar	D555FL09	KAPURTHALA ROAD	NON AMR	OK	31.03.2023	Category 2				9154291	1200/577/1-1	5.277	NA	Director/D
B.4962	North	JALANDHAR	11kV	DS Divn. Model Town,	DS S/D Tech-4 Bastian, Jalandhar	D555FL18	GAUJUR	NON AMR	OK	31.03.2023	Category 5-UPS				16199538	1200/577/1-1	6.131	NA	Director/D
B.4963	North	JALANDHAR	11kV	DS Divn. Model Town,	DS S/D Tech-4 Bastian, Jalandhar	D555FL02	SUTLAI	NON AMR	OK	31.03.2023	Category 2				10282783	1200/577/1-1	6.181	NA	Director/D
B.4964	North	JALANDHAR	11kV	DS Divn. Model Town,	DS S/D Tech-4 Bastian, Jalandhar	D555FL14	12 KAMAR	NON AMR	OK	31.03.2023	Category 1				2654768	1200/577/1-1	8.006	NA	Director/D
B.4965	North	JALANDHAR	11kV	DS Divn. Model Town,	DS S/D Tech-4 Bastian, Jalandhar	D555FL19	NEEL KAMAL	NON AMR	OK	31.03.2023	Category 1				2065925	1200/577/1-1	12.238	NA	Director/D
B.4966	North	JALANDHAR	11kV	DS Divn. Model Town,	DS S/D Tech-4 Bastian, Jalandhar	D555FL04	FRIEND	NON AMR	OK	31.03.2023	Category 2				9154207	1200/577/1-1	13.564	NA	Director/D
B.4967	North	JALANDHAR	11kV	DS Divn. Model Town,	DS S/D Tech-4 Bastian, Jalandhar	D555FL07	VIDESH SANCHAR	AMR	OK	31.03.2023	Category 1				13190527	1200/577/1-1	14.410	NA	Director/D
B.4968	North	JALANDHAR	11kV	DS Divn. Model Town,	DS S/D Tech-4 Bastian, Jalandhar	D555FL14	WARYANA COMPLEX NO. 2	AMR	OK	31.03.2023	Category 2				2067377	1200/577/1-1	14.850	NA	Director/D
B.4969	North	JALANDHAR	11kV	DS Divn. Model Town,	DS S/D Tech-4 Bastian, Jalandhar	D555FL10	BASTI BAWA KHEL	NON AMR	OK	31.03.2023	Category 1				2067125	1200/577/1-1	15.245	NA	Director/D
B.4970	North	JALANDHAR	11kV	DS Divn. Model Town,	DS S/D Tech-4 Bastian, Jalandhar	D555FL06	CANAL	NON AMR	OK	31.03.2023	Category 1				13190513	1200/577/1-1	15.347	NA	Director/D
B.4971	North	JALANDHAR	11kV	DS Divn. Model Town,	DS S/D Tech-4 Bastian, Jalandhar	D555FL02	BASTI NDH (NEW)	Not available	OK	31.03.2023	Category 1				4221069	1200-600/5	11.519	NA	Director/D
B.4972	North	JALANDHAR	11kV	DS Divn. Model Town,	DS S/D Tech-4 Bastian, Jalandhar	D555FL20	Juneja Iron	AMR	OK	31.03.2023	Category 2				Not available	Not available	3.072	NA	Director/D
B.4973	North	JALANDHAR	11kV	DS DIVN. PHAGWARA	DS S/D Tech unit-1 City, Phagwara	C551FL03	STARICH MILL	AMR	OK	31.03.2023	Category 1				7336455	1200/577/1-1	1.237	NA	Director/D
B.4974	North																		

S.No	Zone	Circle	Voltage (kVA)	Division (kVA)	Sub-Division (kVA)	Feeder ID	Feeder Name	Feeder Metering Status (Metered/unmetered/AMR/AMI)	Status of Meter (Functional/Non-functional)	Metering Date	Date of last actual meter working communication	Feeder Type (Agr/Industrial/Mixed)	Status of Communication		Total Number of hours in the period	Period from 01.04.2021 to 31.03.2022				Sales	Remarks (Source of data)
													% data received through automatically if feeder AMR/AMI	Number of hours when meter was unable to communicate in period		Meter S.No	CT/Ratio	Import (kU)	Export (kU)		
B.5014	North	JALANDHAR	11KV	DS DIVN. PHAGWARA	DS S/D Tech Unit-2 Suburban, Phagwara	E553F04	LNK FEEDER	AMR	OK	31.03.2023		Category 1			11116975	900-450/5	11964		NA	Director/D	
B.5015	North	JALANDHAR	11KV	DS DIVN. PHAGWARA	DS S/D Tech Unit-2 Suburban, Phagwara	E553F03	KLARWARA GATE	AMR	OK	31.03.2023		Category 1			4187126	900-450/577/1-1	12608		NA	Director/D	
B.5016	North	JALANDHAR	11KV	DS DIVN. PHAGWARA	DS S/D Tech Unit-2 Suburban, Phagwara	E670F08	PANDORI	NON AMR	OK	31.03.2023		AP 3Phase 3Wire			16194333	1200-600/5	2,252		NA	Director/D	
B.5017	North	JALANDHAR	11KV	DS DIVN. PHAGWARA	DS S/D Tech Unit-2 Suburban, Phagwara	E670F10	AKOLAAMI	NON AMR	OK	31.03.2023		AP 3Phase 3Wire			1200-600/5	2,344		NA	Director/D		
B.5018	North	JALANDHAR	11KV	DS DIVN. PHAGWARA	DS S/D Rural CHEHERU, Phagwara	E55312	SIKRI	AMR	OK	31.03.2023		AP 3Phase 3Wire			1452	900-450/577/1-1	1,649		NA	Director/D	
B.5019	North	JALANDHAR	11KV	DS DIVN. PHAGWARA	DS S/D Rural CHEHERU, Phagwara	E553F07	KHAJURALA	AMR	OK	31.03.2023		AP 3Phase 3Wire			8223225	1200/577/1-1	1,888		NA	Director/D	
B.5020	North	JALANDHAR	11KV	DS DIVN. PHAGWARA	DS S/D Rural CHEHERU, Phagwara	E553F09	JAGPAL PUR	AMR	OK	31.03.2023		AP 3Phase 3Wire			8223209	900-450/577/1-1	2,020		NA	Director/D	
B.5021	North	JALANDHAR	11KV	DS DIVN. PHAGWARA	DS S/D Rural CHEHERU, Phagwara	E553F10	Madhopur	AMR	OK	31.03.2023		AP 3Phase 3Wire			1111741	900-450/577/1-1	2,237		NA	Director/D	
B.5022	North	JALANDHAR	11KV	DS DIVN. PHAGWARA	DS S/D Rural CHEHERU, Phagwara	E553F05	RANI PUR	AMR	OK	31.03.2023		AP 3Phase 3Wire			8223030	1200/577/1-1	2,366		NA	Director/D	
B.5023	North	JALANDHAR	11KV	DS DIVN. PHAGWARA	DS S/D Rural CHEHERU, Phagwara	E553F03	MAHERU FEEDER	AMR	OK	31.03.2023		AP 3Phase 3Wire			5437735	1200/577/1-1	2,383		NA	Director/D	
B.5024	North	JALANDHAR	11KV	DS DIVN. PHAGWARA	DS S/D Rural CHEHERU, Phagwara	E553F04	RAM SAR	AMR	OK	31.03.2023		AP 3Phase 3Wire			8223221	1200/577/1-1	2,410		NA	Director/D	
B.5025	North	JALANDHAR	11KV	DS DIVN. PHAGWARA	DS S/D Rural CHEHERU, Phagwara	E553F02	CHEHERU	AMR	OK	31.03.2023		AP 3Phase 3Wire			8223026	900-450/577/1-1	2,798		NA	Director/D	
B.5026	North	JALANDHAR	11KV	DS DIVN. PHAGWARA	DS S/D Rural CHEHERU, Phagwara	E553F01	THIRD WIRE	NON AMR	OK	31.03.2023		Category 5-UPS			2066254	1200/577/1-1	2,873		NA	Director/D	
B.5027	North	JALANDHAR	11KV	DS DIVN. PHAGWARA	DS S/D Rural CHEHERU, Phagwara	E553F11	SEMI	AMR	OK	31.03.2023		Category 5-UPS			23261	900-450/577/1-1	3,331		NA	Director/D	
B.5028	North	JALANDHAR	11KV	DS DIVN. PHAGWARA	DS S/D Rural CHEHERU, Phagwara	E553F08	LOVELY	AMR	OK	31.03.2023		Category 5-UPS			2066298	900-450/577/1-1	4,944		NA	Director/D	
B.5029	North	JALANDHAR	11KV	DS DIVN. PHAGWARA	DS S/D Rural CHEHERU, Phagwara	E553F06	BONE MILL	NON AMR	OK	31.03.2023		Category 1			8223029	900-450/577/1-1	5,247		NA	Director/D	
B.5030	North	JALANDHAR	11KV	DS DIVN. PHAGWARA	DS S/D Rural CHEHERU, Phagwara	E553F13	MANDI	Not available	OK	31.03.2023		Category 5-UPS			11117141	1200/577/1-1	6,993		NA	Director/D	
B.5031	North	JALANDHAR	66KV	DS DIVN. PHAGWARA	DS S/D Rural CHEHERU, Phagwara	O562C03	lovely	NON AMR	OK	31.03.2023		Category 4			Not available	Not available	21,762		NA	Director/D	
B.5032	North	JALANDHAR	11KV	DS DIVN. PHAGWARA	DS S/D Rural PANCHHTA, Phagwara	D704F12	NARUR	NON AMR	OK	31.03.2023		AP 3Phase 3Wire			100	1200/577/1-1	1,133		NA	Director/D	
B.5033	North	JALANDHAR	11KV	DS DIVN. PHAGWARA	DS S/D Rural PANCHHTA, Phagwara	D704F07	SAINI	AMR	OK	31.03.2023		AP 3Phase 3Wire			11117330	1200/577/1-1	2,094		NA	Director/D	
B.5034	North	JALANDHAR	11KV	DS DIVN. PHAGWARA	DS S/D Rural PANCHHTA, Phagwara	D704F01	NASARABAD	NON AMR	OK	31.03.2023		Category 5-UPS			11114577	1200/577/1-1	2,453		NA	Director/D	
B.5035	North	JALANDHAR	11KV	DS DIVN. PHAGWARA	DS S/D Rural PANCHHTA, Phagwara	D709F02	DIHANA	AMR	OK	31.03.2023		AP 3Phase 3Wire			8223052	900-450/577/1-1	3,030		NA	Director/D	
B.5036	North	JALANDHAR	11KV	DS DIVN. PHAGWARA	DS S/D Rural PANCHHTA, Phagwara	D670F06	Wahid	AMR	OK	31.03.2023		Category 5-UPS			43125	1200-600/5	2,455		NA	Director/D	
B.5037	North	JALANDHAR	11KV	DS DIVN. PHAGWARA	DS S/D Rural PANCHHTA, Phagwara	D670F05	Nadalon	AMR	OK	31.03.2023		AP 3Phase 3Wire			43186	1200-600/5	2,587		NA	Director/D	
B.5038	North	JALANDHAR	11KV	DS DIVN. PHAGWARA	DS S/D Rural PANCHHTA, Phagwara	F712F04	RAJALI	NON AMR	OK	31.03.2023		Kandi Mixed			2064223	900-450/577/1-1	4,611		NA	Director/D	
B.5039	North	JALANDHAR	11KV	DS DIVN. PHAGWARA	DS S/D Rural PANCHHTA, Phagwara	O566F13	Behalpur	AMR	OK	31.03.2023		AP 3Phase 3Wire			12479852	900-450/5	1,901		NA	Director/D	
B.5040	North	JALANDHAR	11KV	DS DIVN. PHAGWARA	DS S/D Rural PANCHHTA, Phagwara	O566F14	RANDHIGARH	NON AMR	OK	31.03.2023		AP 3Phase 3Wire			5277	1200/577/1-1	2,110		NA	Director/D	
B.5041	North	JALANDHAR	11KV	DS DIVN. PHAGWARA	DS S/D Rural PANCHHTA, Phagwara	O566F11	TOODER PUR	AMR	OK	31.03.2023		AP 3Phase 3Wire			2068330	900-450/5	2,179		NA	Director/D	
B.5042	North	JALANDHAR	11KV	DS DIVN. PHAGWARA	DS S/D Rural PANCHHTA, Phagwara	O566F12	malikpur	AMR	OK	31.03.2023		AP 3Phase 3Wire			12093579	1200/577/1-1	2,380		NA	Director/D	
B.5043	North	JALANDHAR	11KV	DS DIVN. PHAGWARA	DS S/D Rural PANCHHTA, Phagwara	O566F08	WALDI	AMR	OK	31.03.2023		AP 3Phase 3Wire			2066551	900-450/5	2,425		NA	Director/D	
B.5044	North	JALANDHAR	11KV	DS DIVN. PHAGWARA	DS S/D Rural PANCHHTA, Phagwara	O566F05	JALWERA	AMR	OK	31.03.2023		AP 3Phase 3Wire			800-450/5	2,844		NA	Director/D		
B.5045	North	JALANDHAR	11KV	DS DIVN. PHAGWARA	DS S/D Rural PANCHHTA, Phagwara	O566F09	panshata RURAL	AMR	OK	31.03.2023		AP 3Phase 3Wire			2099	1200/577/1-1	3,133		NA	Director/D	
B.5046	North	JALANDHAR	11KV	DS DIVN. PHAGWARA	DS S/D Rural PANCHHTA, Phagwara	O566F10	BAGANA	NON AMR	OK	31.03.2023		AP 3Phase 3Wire			8222699	900-450/5	3,227		NA	Director/D	
B.5047	North	JALANDHAR	11KV	DS DIVN. PHAGWARA	DS S/D Rural PANCHHTA, Phagwara	O566F07	panshata urban	AMR	OK	31.03.2023		Category 1			2067225	900-450/5	3,572		NA	Director/D	
B.5048	North	JALANDHAR	11KV	DS DIVN. PHAGWARA	DS S/D Rural PANCHHTA, Phagwara	O566F04	BADDON	NON AMR	OK	31.03.2023		Kandi Mixed			822853	1200/577/1-1	7,947		NA	Director/D	
B.5049	North	JALANDHAR	11KV	DS DIVN. PHAGWARA	DS S/D Rural PANCHHTA, Phagwara	O566F06	BHUNGARNI	AMR	OK	31.03.2023		Category 5-UPS			8223670	900-450/5	8,489		NA	Director/D	
B.5050	North	JALANDHAR	11KV	DS DIVN. PHAGWARA	DS S/D Tech. Unit-3 Hadliabad, Phagwara	E553F10	11kv interlinking s/s sugar ml	NON AMR	OK	31.03.2023		Category 1			2065630	900-450/577/1-1	17,585		NA	Director/D	
B.5051	North	JALANDHAR	11KV	DS DIVN. PHAGWARA	DS S/D Tech. Unit-3 Hadliabad, Phagwara	E553F20	Bhansoli Road	NON AMR	OK	31.03.2023		Category 1			7042954	900-450/5	6,174		NA	Director/D	
B.5052	North	JALANDHAR	11KV	DS DIVN. PHAGWARA	DS S/D Tech. Unit-3 Hadliabad, Phagwara	0712F18	NEW LAKHANPUL	NON AMR	OK	31.03.2023		Category 1			16194326	900-450/577/1-1	2,382		NA	Director/D	
B.5053	North	JALANDHAR	11KV	DS DIVN. PHAGWARA	DS S/D Tech. Unit-3 Hadliabad, Phagwara	0712F20	BANDALA ROAD	NON AMR	OK	31.03.2023		AP 3Phase 3Wire			16194371	900-450/577/1-1	2,638		NA	Director/D	
B.5054	North	JALANDHAR	11KV	DS DIVN. PHAGWARA	DS S/D Tech. Unit-3 Hadliabad, Phagwara	0712F19	NEW DHAM PIND	AMR	OK	31.03.2023		AP 3Phase 3Wire			16194347	900-450/577/1-1	2,726		NA	Director/D	
B.5055	North	JALANDHAR	11KV	DS DIVN. PHAGWARA	DS S/D Tech. Unit-3 Hadliabad, Phagwara	0712F23	Phagwara Road	NON AMR	OK	31.03.2023		AP 3Phase 3Wire			9685	900-450/577/1-1	2,773		NA	Director/D	
B.5056	North	JALANDHAR	11KV	DS DIVN. PHAGWARA	DS S/D Tech. Unit-3 Hadliabad, Phagwara	0712F17	NEW SARHAI FEEDER	AMR	OK	31.03.2023		Category 1			16194336	900-450/577/1-1	2,853		NA	Director/D	
B.5057	North	JALANDHAR	11KV	DS DIVN. PHAGWARA	DS S/D Tech. Unit-3 Hadliabad, Phagwara	O562F24	11 KV LAW GATE FEEDER	AMR	OK	31.03.2023		Category 5-UPS			35746	1200-600/5	0,123		NA	Director/D	
B.5058	North	JALANDHAR	11KV	DS DIVN. PHAGWARA	DS S/D Tech. Unit-3 Hadliabad, Phagwara	O562F02	SARHAI	AMR	OK	31.03.2023		AP 3Phase 3Wire			11052035	1200-600/5	0,442		NA	Director/D	
B.5059	North	JALANDHAR	11KV	DS DIVN. PHAGWARA	DS S/D Tech. Unit-3 Hadliabad, Phagwara	O562F11	NATHWAL	NON AMR	OK	31.03.2023		AP 3Phase 3Wire			777873	1200-600/5	1,503		NA	Director/D	
B.5060	North	JALANDHAR	11KV	DS DIVN. PHAGWARA	DS S/D Tech. Unit-3 Hadliabad, Phagwara	O562F01	lica pind	AMR	OK	31.03.2023		AP 3Phase 3Wire			9534521	1200-600/5	1,680		NA	Director/D	
B.5061	North	JALANDHAR	11KV	DS DIVN. PHAGWARA	DS S/D Tech. Unit-3 Hadliabad, Phagwara	O562F16	11KV MIRAPUR FEEDER	AMR	OK	31.03.2023		AP 3Phase 3Wire			1206334	1200-600/5	1,823		NA	Director/D	
B.5062	North	JALANDHAR	11KV	DS DIVN. PHAGWARA	DS S/D Tech. Unit-3 Hadliabad, Phagwara	O562F09	DARVESH PIND	AMR	OK	31.03.2023		AP 3Phase 3Wire			2066366	1200-600/5	1,855		NA	Director/D	
B.5063	North	JALANDHAR	11KV	DS DIVN. PHAGWARA	DS S/D Tech. Unit-3 Hadliabad, Phagwara	O562F03	DHANI PIND	AMR	OK	31.03.2023		AP 3Phase 3Wire			8223768	900-450/5	2,029		NA	Director/D	
B.5064	North	JALANDHAR	11KV	DS DIVN. PHAGWARA	DS S/D Tech. Unit-3 Hadliabad, Phagwara	O562F08	HARDO FRALA	AMR	OK	31.03.2023		AP 3Phase 3Wire			8223769	900-450/5	2,441		NA	Director/D	
B.5065	North	JALANDHAR	11KV	DS DIVN. PHAGWARA	DS S/D Tech. Unit-3 Hadliabad, Phagwara	O562F06	SALARPUR	NON AMR	OK	31.03.2023		AP 3Phase 3Wire			8223770	1200-600/5	2,560		NA	Director/D	
B.5066	North	JALANDHAR	11KV	DS DIVN. PHAGWARA	DS S/D Tech. Unit-3 Hadliabad, Phagwara	O562F12	11KV RIAPUR	AMR	OK	31.03.2023		AP 3Phase 3Wire			10288306	1200-600/5	2,562		NA	Director/D	
B.5067	North	JALANDHAR	11KV	DS DIVN. PHAGWARA	DS S/D Tech. Unit-3 Hadliabad, Phagwara	O562F07	NEW SARHAI FEEDER	NON AMR	OK	31.03.2023		AP 3Phase 3Wire			16194336	900-450/5	2,570		NA	Director/D	
B.5068	North	JALANDHAR	11KV	DS DIVN. PHAGWARA	DS S/D Tech. Unit-3 Hadliabad, Phagwara	O562F07	DADUVAL	NON AMR	OK	31.03.2023		AP 3Phase 3Wire			8223766						

S.No	Zone	Circle	Voltage Level (kVA)	Division (kVA)	Sub-Division (kVA)	Feeder ID	Feeder Name	Feeder Metering Status (Metered/unmetered/AMR/AMI)	Status of Meter (Functional/Non-Functional)	Metering Date (Date of last actual meter reading/communication)	Feeder Type (Agri/Industrial/Mixed)	Status of Communication			Period from 01.04.2021 to 31.03.2022				Sales	Remarks (Source of data)
												% data received through automatically if feeder AMR/AMI	Number of hours when meter was unable to communicate in overall	Total Number of hours in the period	Meter S.No	CT/PT ratio	Import (kWh)	Export (kWh)		
B.5111	North	JALANDHAR	11KV	DS Divn. West. Jalandhar	DS S/D Tech-2 Maqsudan, Jalandhar	D553FL03	Gopal Nagar	NON AMR	OK	31.03.2023	Category 1				33668	600/577/1-1-1	12.543	NA	Director/D	
B.5112	North	JALANDHAR	11KV	DS Divn. West. Jalandhar	DS S/D Tech-2 Maqsudan, Jalandhar	D553FL02	BASTI DANSHMANDA	NON AMR	OK	31.03.2023	Category 1				36860	600/577/1-1-1	14.997	NA	Director/D	
B.5113	North	JALANDHAR	11KV	DS Divn. West. Jalandhar	DS S/D Tech-2 Maqsudan, Jalandhar	D567FL07	TACORE HOSPITAL	NON AMR	OK	31.03.2023	Category 4				24336	Not installed	3.683	NA	Director/D	
B.5114	North	JALANDHAR	11KV	DS Divn. West. Jalandhar	DS S/D Tech-2 Maqsudan, Jalandhar	D567FL10	11KV SANGAT SINGH NAGAR	NON AMR	OK	31.03.2023	Category 1				24336	Not installed	7.028	NA	Director/D	
B.5115	North	JALANDHAR	11KV	DS Divn. West. Jalandhar	DS S/D Tech-2 Maqsudan, Jalandhar	D567FL11	11KV GRAM MARKET	NON AMR	OK	31.03.2023	Category 1				24339	Not installed	10.024	NA	Director/D	
B.5116	North	JALANDHAR	11KV	DS Divn. West. Jalandhar	DS S/D Tech-3 MAI HIRAN GATE, JALANDHAR	D567FL15	Jalavay Vihar	NON AMR	OK	31.03.2023	Category 1				33715	Not installed	0.334	NA	Director/D	
B.5117	North	JALANDHAR	11KV	DS Divn. West. Jalandhar	DS S/D Tech-3 MAI HIRAN GATE, JALANDHAR	D567FL06	Chok Sudan	NON AMR	OK	31.03.2023	Category 1				24392	1200/577/1-1-1	3.040	NA	Director/D	
B.5118	North	JALANDHAR	11KV	DS Divn. West. Jalandhar	DS S/D Tech-3 MAI HIRAN GATE, JALANDHAR	D567FL13	11KV GANDHI CAMP	NON AMR	OK	31.03.2023	Category 1				24288	Not installed	4.507	NA	Director/D	
B.5119	North	JALANDHAR	11KV	DS Divn. West. Jalandhar	DS S/D Tech-3 MAI HIRAN GATE, JALANDHAR	D567FL02	Shita Mandir	NON AMR	OK	31.03.2023	Category 1				24390	1200/577/1-1-1	4.738	NA	Director/D	
B.5120	North	JALANDHAR	11KV	DS Divn. West. Jalandhar	DS S/D Tech-3 MAI HIRAN GATE, JALANDHAR	D567FL05	GAZI GULLA	NON AMR	OK	31.03.2023	Category 1				24335	1200/577/1-1-1	5.908	NA	Director/D	
B.5121	North	JALANDHAR	11KV	DS Divn. West. Jalandhar	DS S/D Tech-3 MAI HIRAN GATE, JALANDHAR	D567FL14	11KV MAI HIRAN GATE	NON AMR	OK	31.03.2023	Category 1				24269	Not installed	8.325	NA	Director/D	
B.5122	North	JALANDHAR	11KV	DS Divn. West. Jalandhar	DS S/D Tech-3 MAI HIRAN GATE, JALANDHAR	D567FL16	ATTARI BAZAAR	NON AMR	OK	31.03.2023	Category 1				7314191	Not installed	8.521	NA	Director/D	
B.5123	North	JALANDHAR	11KV	DS Divn. West. Jalandhar	DS S/D Tech-3 MAI HIRAN GATE, JALANDHAR	D567FL12	11KV CHANDAN NAGAR	NON AMR	OK	31.03.2023	Category 1				24389	1200/577/1-1-1	13.547	NA	Director/D	
B.5124	North	JALANDHAR	11KV	DS Divn. West. Jalandhar	DS S/D Tech-3 MAI HIRAN GATE, JALANDHAR	D567FL20	11KV LAXMI PURA	NON AMR	OK	31.03.2023	Category 1				383769	600/577/1-1-1	8.104	NA	Director/D	
B.5125	North	JALANDHAR	11KV	DS Divn. West. Jalandhar	DS S/D Tech-3 MAI HIRAN GATE, JALANDHAR	D567FL01	ROON HOSHARPUR	NON AMR	OK	31.03.2023	Category 1				10282818	600-500/577/1-1-1	12.387	NA	Director/D	
B.5126	North	JALANDHAR	11KV	DS Divn. West. Jalandhar	DS S/D Tech-3 MAI HIRAN GATE, JALANDHAR	D553FL04	RAJ TALAB	AMR	OK	31.03.2023	Category 1				4221143	600/577/1-1-1	5.154	NA	Director/D	
B.5127	North	JALANDHAR	11KV	DS Divn. West. Jalandhar	DS S/D Tech-4 Patel Chowk, Jalandhar	0713FL18	SANT RUBBER	AMR	OK	31.03.2023	Category 2				6257	1200-600/5	0.034	NA	Director/D	
B.5128	North	JALANDHAR	11KV	DS Divn. West. Jalandhar	DS S/D Tech-4 Patel Chowk, Jalandhar	0713FL17	PUNJAB RAI CHAMRA UDYO	NON AMR	OK	31.03.2023	Category 4				5514	1200-600/5	0.132	NA	Director/D	
B.5129	North	JALANDHAR	11KV	DS Divn. West. Jalandhar	DS S/D Tech-4 Patel Chowk, Jalandhar	0713FL09	Hellian	NON AMR	OK	31.03.2023	AP 3Phase 3Wire				2536	1200-600/5	1.197	NA	Director/D	
B.5130	North	JALANDHAR	11KV	DS Divn. West. Jalandhar	DS S/D Tech-4 Patel Chowk, Jalandhar	0713FL27	JAINDEERA TOOLS	NON AMR	OK	31.03.2023	Category 2				525518	1200-600/5	1.915	NA	Director/D	
B.5131	North	JALANDHAR	11KV	DS Divn. West. Jalandhar	DS S/D Tech-4 Patel Chowk, Jalandhar	0713FL03	TREATMENT PLD NO. 1	NON AMR	OK	31.03.2023	Category 1				525515	1200-600/5	5.389	NA	Director/D	
B.5132	North	JALANDHAR	11KV	DS Divn. West. Jalandhar	DS S/D Tech-4 Patel Chowk, Jalandhar	0713FL01	DRY LATHER COMPLEX	NON AMR	OK	31.03.2023	Category 2				525509	1200-600/5	10.030	NA	Director/D	
B.5133	North	JALANDHAR	11KV	DS Divn. West. Jalandhar	DS S/D Tech-4 Patel Chowk, Jalandhar	0713FL06	FLAIR INTERNATIONAL	NON AMR	OK	31.03.2023	Category 2				525519	1200-600/5	12.524	NA	Director/D	
B.5134	North	JALANDHAR	11KV	DS Divn. West. Jalandhar	DS S/D Tech-4 Patel Chowk, Jalandhar	D553FL12	TALWARA	NON AMR	OK	31.03.2023	AP 3Phase 3Wire				33426	1200/577/1-1-1	2.493	NA	Director/D	
B.5135	North	JALANDHAR	11KV	DS Divn. West. Jalandhar	DS S/D Tech-4 Patel Chowk, Jalandhar	D553FL18	Mand	NON AMR	OK	31.03.2023	AP 3Phase 3Wire				4189557	600/577/1-1-1	3.255	NA	Director/D	
B.5136	North	JALANDHAR	11KV	DS Divn. West. Jalandhar	DS S/D Tech-4 Patel Chowk, Jalandhar	D553FL19	BAJAJ NAO (OLD)	NON AMR	OK	31.03.2023	Category 1				191978	600/577/1-1-1	4.261	NA	Director/D	
B.5137	North	JALANDHAR	11KV	DS Divn. West. Jalandhar	DS S/D Tech-4 Patel Chowk, Jalandhar	D553FL18	Heru per	NON AMR	OK	31.03.2023	Category 5-UPS				2067261	600/577/1-1-1	7.766	NA	Director/D	
B.5138	North	JALANDHAR	11KV	DS Divn. West. Jalandhar	DS S/D Tech-4 Patel Chowk, Jalandhar	D567FL08	JOSHI HOSPITAL	NON AMR	OK	31.03.2023	Category 1				24337	1200/577/1-1-1	2.456	NA	Director/D	
B.5139	North	JALANDHAR	11KV	DS Divn. West. Jalandhar	DS S/D Tech-4 Patel Chowk, Jalandhar	D567FL09	HARNAM DASS PURA	NON AMR	OK	31.03.2023	Category 1				24393	1200/577/1-1-1	5.171	NA	Director/D	
B.5140	North	JALANDHAR	11KV	DS Divn. West. Jalandhar	DS S/D Tech-4 Patel Chowk, Jalandhar	D567FL04	SARWATI VIHAR	NON AMR	OK	31.03.2023	Category 1				24396	Not installed	8.597	NA	Director/D	
B.5141	North	JALANDHAR	11KV	DS Divn. West. Jalandhar	DS S/D Tech-4 Patel Chowk, Jalandhar	D567FL03	NAZ	NON AMR	OK	31.03.2023	Category 1				24295	Not installed	9.424	NA	Director/D	
B.5142	North	JALANDHAR	11KV	DS Divn. West. Jalandhar	DS S/D Tech-4 Patel Chowk, Jalandhar	D567FL02	MG G.N	NON AMR	OK	31.03.2023	Category 1				24336	1200/577/1-1-1	12.053	NA	Director/D	
B.5143	North	JALANDHAR	11KV	DS Divn. West. Jalandhar	DS S/D Tech-4 Patel Chowk, Jalandhar	D554FL1	JANSON INDUSTRIES	NON AMR	OK	31.03.2023	Category 2				9154263	1200/577/1-1-1	0.403	NA	Director/D	
B.5144	North	JALANDHAR	11KV	DS Divn. West. Jalandhar	DS S/D Tech-4 Patel Chowk, Jalandhar	0713FL10	METRO MILK	NON AMR	OK	31.03.2023	Category 4				5503	1200/577/1-1-1	3.001	NA	Director/D	
B.5145	North	JALANDHAR	11KV	DS Divn. West. Jalandhar	DS S/D Tech-4 Patel Chowk, Jalandhar	FL22D554	GANDA NALA	AMR	OK	31.03.2023	Category 1				24332	1200/577/1-1-1	3.057	NA	Director/D	
B.5146	North	JALANDHAR	11KV	DS Divn. West. Jalandhar	DS S/D Tech-4 Patel Chowk, Jalandhar	D554FL03	SURGICAL COMPLEX	NON AMR	OK	31.03.2023	Category 2				2067789	1200/577/1-1-1	4.936	NA	Director/D	
B.5147	North	JALANDHAR	11KV	DS Divn. West. Jalandhar	DS S/D Tech-4 Patel Chowk, Jalandhar	D554FL21	TREATMENT NO.2	NON AMR	OK	31.03.2023	Category 2				16499568	1200/577/1-1-1	7.176	NA	Director/D	
B.5148	North	JALANDHAR	11KV	DS Divn. West. Jalandhar	DS S/D Tech-4 Patel Chowk, Jalandhar	D554FL23	SPORTS COLLEGE	NON AMR	OK	31.03.2023	Category 1				33688	1200/577/1-1-1	7.356	NA	Director/D	
B.5149	North	JALANDHAR	11KV	DS Divn. West. Jalandhar	DS S/D Tech-4 Patel Chowk, Jalandhar	D554FL22	RAJA GARDEN	AMR	OK	31.03.2023	Category 1				33704	1200/577/1-1-1	7.515	NA	Director/D	
B.5150	North	JALANDHAR	11KV	DS Divn. West. Jalandhar	DS S/D Tech-4 Patel Chowk, Jalandhar	D554FL25	NIVIA SPORTS	NON AMR	OK	31.03.2023	Category 2				16199586	1200/577/1-1-1	9.717	NA	Director/D	
B.5151	North	JALANDHAR	11KV	DS Divn. West. Jalandhar	DS S/D Tech-4 Patel Chowk, Jalandhar	D554FL15	BASTI PER DAD	NON AMR	OK	31.03.2023	Category 1				16199493	1200/577/1-1-1	10.910	NA	Director/D	
B.5152	North	JALANDHAR	11KV	DS Divn. West. Jalandhar	DS S/D Tech-4 Patel Chowk, Jalandhar	D554FL13	BASTI MITHU	NON AMR	OK	31.03.2023	Category 1				16199494	1200/577/1-1-1	12.038	NA	Director/D	
B.5153	North	JALANDHAR	11KV	DS Divn. West. Jalandhar	DS S/D Tech-4 Patel Chowk, Jalandhar	D554FL01	NATIONAL	AMR	OK	31.03.2023	Category 2				13194068	1200/577/1-1-1	16.838	NA	Director/D	
B.5154	North	JALANDHAR	11KV	DS Divn. West. Jalandhar	DS S/D Tech-4 Patel Chowk, Jalandhar	D554FL05	LEATHER COMPLEX	NON AMR	OK	31.03.2023	Category 2				2068743	1200/577/1-1-1	18.182	NA	Director/D	
B.5155	North	JALANDHAR	11KV	DS Divn. West. Jalandhar	DS S/D Tech-4 Patel Chowk, Jalandhar	D556FL08	T.V.CENTER	NON AMR	OK	31.03.2023	Category 4				2068350	1200-600/5	0.706	NA	Director/D	
B.5156	North	JALANDHAR	11KV	DS Divn. West. Jalandhar	DS S/D Tech-4 Patel Chowk, Jalandhar	D556FL07	ADARSH NAGAR	NON AMR	OK	31.03.2023	Category 1				5437712	1200-600/5	4.466	NA	Director/D	
B.5157	North	JALANDHAR	11KV	DS Divn. West. Jalandhar	DS S/D Tech-4 Patel Chowk, Jalandhar	D556FL03	SHAKTI NAGAR	AMR	OK	31.03.2023	Category 1				5295586	1200-600/5	8.746	NA	Director/D	
B.5158	North	KAPURTHALA	11KV	DS CITY DIVN. KAPURTHALA	DS S/D CITY-1 KAPURTHALA	C601FL24	KRISHNA	AMR	OK	31.03.2023	Category 1				8228386	1200/577/1-1-1	0.029	NA	Director/D	
B.5159	North	KAPURTHALA	11KV	DS CITY DIVN. KAPURTHALA	DS S/D CITY-1 KAPURTHALA	C601FL13	NATHU CHAHAL	AMR	OK	31.03.2023	AP 3Phase 3Wire				8228388	600/577/1-1-1	1.307	NA	Director/D	
B.5160	North	KAPURTHALA	11KV	DS CITY DIVN. KAPURTHALA	DS S/D CITY-1 KAPURTHALA	C601FL22	11KV Brindrap AP	AMR	OK	31.03.2023	AP 3Phase 3Wire				1	900-450/577/1-1-1	5.696	NA	Director/D	
B.5161	North	KAPURTHALA	11KV	DS CITY DIVN. KAPURTHALA	DS S/D CITY-1 KAPURTHALA	C601FL08	URBAN SHEKHUPUR	AMR	OK	31.03.2023	Category 1				9141101	1200/577/1-1-1	7.100	NA	Director/D	
B.5162	North	KAPURTHALA	11KV	DS CITY DIVN. KAPURTHALA	DS S/D CITY-1 KAPURTHALA	C601FL07	ANAND AGGARWAL	AMR	OK	31.03.2023	Category 1				2067463	1200/577/1-1-1	7.472	NA	Director/D	
B.5163	North	KAPURTHALA	11KV	DS CITY DIVN. KAPURTHALA	DS S/D CITY-1 KAPURTHALA	C601FL23	11KV MAIL TECH	AMR	OK	31.03.2023	Category 2				1	900-450/577/1-1-1	9.468	NA	Director/D	
B.5164	North	KAPURTHALA	11KV	DS CITY DIVN. KAPURTHALA	DS S/D CITY-1 KAPURTHALA	C601FL05	FACTORY AREA	AMR	OK	31.03.2023	Category 1				7030212	1200/577/1-1-1	10.077	NA	Director/D	
B.5165	North	KAPURTHALA	11KV	DS CITY DIVN. KAPURTHALA	DS S/D CITY-1 KAPURTHALA	C601FL18	Katu Chawk	AMR	OK	31.03.2023	Category 2				1	1200/577/1-1-1	11.015	NA	Director/D	
B.5166	North	KAPURTHALA	11KV	DS CITY DIVN. KAPURTHALA	DS S/D CITY-1 KAPURTHALA	C601FL10	URBAN MARKFED	NON AMR	OK	31.03.2023	Category 1				1008948	1200/577/1-1-1	11.824	NA	Director/D	
B.5167	North	KAPURTHALA	11KV	DS CITY DIVN. KAPURTHALA	DS S/D CITY-1 KAPURTHALA	C601FL19	Purani Dana mandi	AMR	OK	31.03.2023	Category 1				2066223	1200/577/1-1-1	12.857	NA	Director/D	
B.5168	North	KAPURTHALA	11KV	DS CITY DIVN. KAPURTHALA	DS S/D CITY-1 KAPURTHALA	C601FL16	Sangrua	AMR	OK	31.03.2023	Category 1				2	1200/577/1-1-1	14.081	NA	Director/D	
B.5169	North	KAPURTHALA	11KV	DS CITY DIVN. KAPURTHALA	DS S/D CITY-1 KAPURTHALA	C601FL18	BHARNDIPUR	AMR	OK	31.03.2023	AP 3Phase 3Wire				65984	1200-600/5	1.476	NA	Director/D	
B.5170	North	KAPURTHALA	11KV	DS CITY DIVN. KAPURTHALA	DS S/D CITY-1 KAPURTHALA	D567FL15	SADHWAL	NON AMR	OK	31.03.2023	AP 3Phase 3Wire				11051983	1200-600/5	7.752	NA	Director/D	
B.5171	North	KAPURTHALA	11KV	DS CITY DIVN. KAPURTHALA	DS S/D CITY-1 KAPURTHALA	E620FL01	MAJADPUR	AMR	OK	31.03.2023	AP 3Phase 3Wire				7336758	900-450/5	1.777	NA	Director/D	
B.5172	North	KAPURTHALA	11KV	DS CITY DIVN. KAPURTHALA	DS S/D CITY-1 KAPURTHALA	E620FL10	Bhagwanpur	AMR	OK	31.03.2023	Category 5-UPS				PVV01700	900-450/5	3.866	NA	Director/D	
B.5173	North	KAPURTHALA	11KV	DS CITY DIVN. KAPURTHALA	DS S/D CITY-1 KAPURTHALA	E622FL15	S/STN TF Nangal Naryan garh	NON AMR	OK	31.03.2023										

S.No	Zone	Circle	Voltage Level (kVA)	Division (kVA)	Sub-Division (kVA)	Feeder ID	Feeder Name	Feeder Metering Status (Metered/unmetered/AMR/AM)	Status of Meter (Functional/Non-functional)	Metering Date (Date of last actual meter reading/communication)	Feeder Type (Agr/Industrial/Mixed)	Status of Communication			Period from 01.04.2021 to 31.03.2022				Sales	Remarks (Source of data)
												% Data received through automatically if feeder AMR/AM	Number of hours when meter was unable to communicate in week	Total Number of hours in the period	Meter S.No	CT/PT ratio	Import (kWh)	Export (kWh)		
B.5208	North	KAPURTHALA	11KV	DS CITY DIVN. KAPURTH	DS/0 CITY-1 SULTANPUR	D619FL02	SHERPUR DONA	NON AMR	OK	31.03.2023	AP 3Phase 3Wire				9544720	900-450/5	1,797	NA	Director/D	
B.5209	North	KAPURTHALA	11KV	DS CITY DIVN. KAPURTH	DS/0 CITY-1 SULTANPUR	D619FL11	ALLA DITTA	NON AMR	OK	31.03.2023	AP 3Phase 3Wire				33571	900-450/5	1,855	NA	Director/D	
B.5210	North	KAPURTHALA	11KV	DS CITY DIVN. KAPURTH	DS/0 CITY-1 SULTANPUR	D619FL07	LAKHTANWAL	NON AMR	OK	31.03.2023	AP 3Phase 3Wire				33571	900-450/5	2,073	NA	Director/D	
B.5211	North	KAPURTHALA	11KV	DS CITY DIVN. KAPURTH	DS/0 CITY-1 SULTANPUR	D619FL04	MOTI KAWALA	NON AMR	OK	31.03.2023	AP 3Phase 3Wire				8222413	900-450/5	2,243	NA	Director/D	
B.5212	North	KAPURTHALA	11KV	DS CITY DIVN. KAPURTH	DS/0 CITY-1 SULTANPUR	D619FL09	RAJ WAL	AMR	OK	31.03.2023	AP 3Phase 3Wire				2066887	900-450/5	2,298	NA	Director/D	
B.5213	North	KAPURTHALA	11KV	DS CITY DIVN. KAPURTH	DS/0 CITY-1 SULTANPUR	D619FL10	KULLAR	AMR	OK	31.03.2023	AP 3Phase 3Wire				8222659	900-450/5	2,302	NA	Director/D	
B.5214	North	KAPURTHALA	11KV	DS CITY DIVN. KAPURTH	DS/0 CITY-1 SULTANPUR	D619FL03	NARANGPUR	AMR	OK	31.03.2023	AP 3Phase 3Wire				2066499	900-450/5	2,519	NA	Director/D	
B.5215	North	KAPURTHALA	11KV	DS CITY DIVN. KAPURTH	DS/0 CITY-1 SULTANPUR	E607FL15	Kotia Heran	AMR	OK	31.03.2023	Category 5-UPS				V0197961	900-450/5	2,687	NA	Director/D	
B.5216	North	KAPURTHALA	11KV	DS CITY DIVN. KAPURTH	DS/0 CITY-1 SULTANPUR	D619FL18	11 KV CHACHO WAL	AMR	OK	31.03.2023	Category 5-UPS				PVV04978	900-450/5	8,661	NA	Director/D	
B.5217	North	KAPURTHALA	11KV	DS CITY DIVN. KAPURTH	DS/0 CITY-1 SULTANPUR	D619FL13	JPS KAMALPUR	AMR	OK	31.03.2023	Category 5-UPS				8222413	900-450/5	9,082	NA	Director/D	
B.5218	North	KAPURTHALA	11KV	DS CITY DIVN. KAPURTH	DS/0 CITY-2 SULTANPUR	B601FL10	GAZIPUR	NON AMR	OK	31.03.2023	AP 3Phase 3Wire				8223269	1200-600/5	0,878	NA	Director/D	
B.5219	North	KAPURTHALA	11KV	DS CITY DIVN. KAPURTH	DS/0 CITY-2 SULTANPUR	B601FL11	SAWAAL	AMR	OK	31.03.2023	AP 3Phase 3Wire				9154290	900-450/5	1,515	NA	Director/D	
B.5220	North	KAPURTHALA	11KV	DS CITY DIVN. KAPURTH	DS/0 CITY-2 SULTANPUR	B601FL12	HARNAMPUR	AMR	OK	31.03.2023	AP 3Phase 3Wire				9154263	1200-600/5	1,765	NA	Director/D	
B.5221	North	KAPURTHALA	11KV	DS CITY DIVN. KAPURTH	DS/0 CITY-2 SULTANPUR	B601FL13	JPS SHALPUR	NON AMR	OK	31.03.2023	Category 5-UPS				9534494	1200-600/5	3,635	NA	Director/D	
B.5222	North	KAPURTHALA	11KV	DS CITY DIVN. KAPURTH	DS/0 CITY-2 SULTANPUR	D617FL05	URBAN Pandori Jagr	NON AMR	OK	31.03.2023	Category 1				9534561	1200/577/1-1	0,584	NA	Director/D	
B.5223	North	KAPURTHALA	11KV	DS CITY DIVN. KAPURTH	DS/0 CITY-2 SULTANPUR	D617FL02	KHURDA	AMR	OK	31.03.2023	AP 3Phase 3Wire				9534547	1200/577/1-1	1,347	NA	Director/D	
B.5224	North	KAPURTHALA	11KV	DS CITY DIVN. KAPURTH	DS/0 CITY-2 SULTANPUR	D617FL14	SANGRA	NON AMR	OK	31.03.2023	AP 3Phase 3Wire				0	1200/577/1-1	1,553	NA	Director/D	
B.5225	North	KAPURTHALA	11KV	DS CITY DIVN. KAPURTH	DS/0 CITY-2 SULTANPUR	D617FL04	MIRZAPUR	NON AMR	OK	31.03.2023	AP 3Phase 3Wire				9534522	1200/577/1-1	1,762	NA	Director/D	
B.5226	North	KAPURTHALA	11KV	DS CITY DIVN. KAPURTH	DS/0 CITY-2 SULTANPUR	D617FL01	PARAMJITPUR PANDORI	AMR	OK	31.03.2023	AP 3Phase 3Wire				9534502	1200/577/1-1	1,855	NA	Director/D	
B.5227	North	KAPURTHALA	11KV	DS CITY DIVN. KAPURTH	DS/0 CITY-2 SULTANPUR	D617FL15	Mahmawal	AMR	OK	31.03.2023	Category 5-UPS				PVV03551	1200/577/1-1	5,584	NA	Director/D	
B.5228	North	KAPURTHALA	11KV	DS CITY DIVN. KAPURTH	DS/0 CITY-2 SULTANPUR	D617FL03	JPS PITTHORAL	NON AMR	OK	31.03.2023	Category 5-UPS				9154383	1200/577/1-1	8,669	NA	Director/D	
B.5229	North	KAPURTHALA	11KV	DS CITY DIVN. KAPURTH	DS/0 CITY-2 SULTANPUR	D613FL01	PARAMJIT PUR	AMR	OK	31.03.2023	AP 3Phase 3Wire				2067238	1200-600/5	1,743	NA	Director/D	
B.5230	North	KAPURTHALA	11KV	DS CITY DIVN. KAPURTH	DS/0 CITY-2 SULTANPUR	D613FL05	NOOR PUR	AMR	OK	31.03.2023	AP 3Phase 3Wire				2066770	1200-600/5	1,862	NA	Director/D	
B.5231	North	KAPURTHALA	11KV	DS CITY DIVN. KAPURTH	DS/0 CITY-2 SULTANPUR	D613FL13	NABIPUR	AMR	OK	31.03.2023	AP 3Phase 3Wire				9140791	1200/577/1-1	1,361	NA	Director/D	
B.5232	North	KAPURTHALA	11KV	DS CITY DIVN. KAPURTH	DS/0 CITY-2 SULTANPUR	D613FL12	BHARO ANA	AMR	OK	31.03.2023	AP 3Phase 3Wire				8223240	1200/577/1-1	1,479	NA	Director/D	
B.5233	North	KAPURTHALA	11KV	DS CITY DIVN. KAPURTH	DS/0 CITY-2 SULTANPUR	E609FL06	LAT WALA	AMR	OK	31.03.2023	AP 3Phase 3Wire				2068584	1200/577/1-1	1,576	NA	Director/D	
B.5234	North	KAPURTHALA	11KV	DS CITY DIVN. KAPURTH	DS/0 CITY-2 SULTANPUR	D613FL02	BUSSOVAL	AMR	OK	31.03.2023	AP 3Phase 3Wire				2068829	1200/577/1-1	1,593	NA	Director/D	
B.5235	North	KAPURTHALA	11KV	DS CITY DIVN. KAPURTH	DS/0 CITY-2 SULTANPUR	D613FL09	SARDALAPUR	AMR	OK	31.03.2023	AP 3Phase 3Wire				8222547	1200/577/1-1	1,644	NA	Director/D	
B.5236	North	KAPURTHALA	11KV	DS CITY DIVN. KAPURTH	DS/0 CITY-2 SULTANPUR	D613FL15	SAROOP WALL	AMR	OK	31.03.2023	AP 3Phase 3Wire				PVV04321	1200/577/1-1	1,858	NA	Director/D	
B.5237	North	KAPURTHALA	11KV	DS CITY DIVN. KAPURTH	DS/0 CITY-2 SULTANPUR	D613FL05	KARIPUR	AMR	OK	31.03.2023	AP 3Phase 3Wire				8223681	1200/577/1-1	1,903	NA	Director/D	
B.5238	North	KAPURTHALA	11KV	DS CITY DIVN. KAPURTH	DS/0 CITY-2 SULTANPUR	D613FL11	KAMME	AMR	OK	31.03.2023	AP 3Phase 3Wire				8223197	1200/577/1-1	1,993	NA	Director/D	
B.5239	North	KAPURTHALA	11KV	DS CITY DIVN. KAPURTH	DS/0 CITY-2 SULTANPUR	E609FL06	JAMBOWAL	AMR	OK	31.03.2023	AP 3Phase 3Wire				8223682	1200/577/1-1	2,006	NA	Director/D	
B.5240	North	KAPURTHALA	11KV	DS CITY DIVN. KAPURTH	DS/0 CITY-2 SULTANPUR	D613FL03	SHAHWALA	AMR	OK	31.03.2023	AP 3Phase 3Wire				2068794	1200/577/1-1	2,028	NA	Director/D	
B.5241	North	KAPURTHALA	11KV	DS CITY DIVN. KAPURTH	DS/0 CITY-2 SULTANPUR	E609FL14	Alluwal	AMR	OK	31.03.2023	AP 3Phase 3Wire				0077726	1200/577/1-1	2,094	NA	Director/D	
B.5242	North	KAPURTHALA	11KV	DS CITY DIVN. KAPURTH	DS/0 CITY-2 SULTANPUR	D613FL04	CHANAN WINDI	AMR	OK	31.03.2023	AP 3Phase 3Wire				8222548	1200/577/1-1	2,188	NA	Director/D	
B.5243	North	KAPURTHALA	11KV	DS CITY DIVN. KAPURTH	DS/0 CITY-2 SULTANPUR	D613FL07	GIDDAN PINDI	NON AMR	OK	31.03.2023	AP 3Phase 3Wire				8223250	1200/577/1-1	2,217	NA	Director/D	
B.5244	North	KAPURTHALA	11KV	DS CITY DIVN. KAPURTH	DS/0 CITY-2 SULTANPUR	E609FL01	JPS SATARGARH	AMR	OK	31.03.2023	Category 5-UPS				8662581	1200/577/1-1	6,045	NA	Director/D	
B.5245	North	KAPURTHALA	11KV	DS CITY DIVN. KAPURTH	DS/0 CITY-2 SULTANPUR	D613FL17	JPS MEER PUR	AMR	OK	31.03.2023	Category 5-UPS				PVV04358	1200/577/1-1	6,103	NA	Director/D	
B.5246	North	KAPURTHALA	11KV	DS CITY DIVN. KAPURTH	DS/0 CITY-2 SULTANPUR	E609FL10	JPS LOOHWAL	AMR	OK	31.03.2023	Category 5-UPS				2046468	1200/577/1-1	7,630	NA	Director/D	
B.5247	North	KAPURTHALA	11KV	DS CITY DIVN. KAPURTH	DS/0 CITY-2 SULTANPUR	D613FL16	JPS Shergur Sadha	AMR	OK	31.03.2023	Category 5-UPS				15193810	1200/577/1-1	8,972	NA	Director/D	
B.5248	North	KAPURTHALA	11KV	DS CITY DIVN. KAPURTH	DS/0 KALA SINGIANA	E603FL08	BANWALPUR	AMR	OK	31.03.2023	AP 3Phase 3Wire				00777378	900-450/577/1-1	1,165	NA	Director/D	
B.5249	North	KAPURTHALA	11KV	DS CITY DIVN. KAPURTH	DS/0 KALA SINGIANA	E603FL03	UGGI	AMR	OK	31.03.2023	AP 3Phase 3Wire				00779158	900-450/577/1-1	1,393	NA	Director/D	
B.5250	North	KAPURTHALA	11KV	DS CITY DIVN. KAPURTH	DS/0 KALA SINGIANA	D634FL14	Nashayalli	AMR	OK	31.03.2023	AP 3Phase 3Wire				8223675	900-450/577/1-1	1,851	NA	Director/D	
B.5251	North	KAPURTHALA	11KV	DS CITY DIVN. KAPURTH	DS/0 KALA SINGIANA	E603FL05	BALER KHANPUR	AMR	OK	31.03.2023	AP 3Phase 3Wire				8223675	900-450/577/1-1	1,936	NA	Director/D	
B.5252	North	KAPURTHALA	11KV	DS CITY DIVN. KAPURTH	DS/0 KALA SINGIANA	E603FL17	Rahimpur	AMR	OK	31.03.2023	AP 3Phase 3Wire				PVV03362	900-450/577/1-1	1,960	NA	Director/D	
B.5253	North	KAPURTHALA	11KV	DS CITY DIVN. KAPURTH	DS/0 KALA SINGIANA	E603FL11	SMLEPUR	AMR	OK	31.03.2023	AP 3Phase 3Wire				00777381	900-450/577/1-1	2,249	NA	Director/D	
B.5254	North	KAPURTHALA	11KV	DS CITY DIVN. KAPURTH	DS/0 KALA SINGIANA	E603FL12	KOHALA AP	AMR	OK	31.03.2023	AP 3Phase 3Wire				39037	900-450/577/1-1	2,362	NA	Director/D	
B.5255	North	KAPURTHALA	11KV	DS CITY DIVN. KAPURTH	DS/0 KALA SINGIANA	D634FL07	NILGAR	NON AMR	OK	31.03.2023	AP 3Phase 3Wire				PVV01669	900-450/577/1-1	2,423	NA	Director/D	
B.5256	North	KAPURTHALA	11KV	DS CITY DIVN. KAPURTH	DS/0 KALA SINGIANA	E603FL10	SANDHI CHATHA	AMR	OK	31.03.2023	AP 3Phase 3Wire				8223680	900-450/577/1-1	2,625	NA	Director/D	
B.5257	North	KAPURTHALA	11KV	DS CITY DIVN. KAPURTH	DS/0 KALA SINGIANA	D634FL13	Tami Sahib	AMR	OK	31.03.2023	AP 3Phase 3Wire				10281266	900-450/577/1-1	2,645	NA	Director/D	
B.5258	North	KAPURTHALA	11KV	DS CITY DIVN. KAPURTH	DS/0 KALA SINGIANA	E603FL04	SUNNERWAL	AMR	OK	31.03.2023	AP 3Phase 3Wire				10281266	900-450/577/1-1	2,821	NA	Director/D	
B.5259	North	KAPURTHALA	11KV	DS CITY DIVN. KAPURTH	DS/0 KALA SINGIANA	E603FL06	ATHOLA	NON AMR	OK	31.03.2023	AP 3Phase 3Wire				00777318	900-450/577/1-1	3,269	NA	Director/D	
B.5260	North	KAPURTHALA	11KV	DS CITY DIVN. KAPURTH	DS/0 KALA SINGIANA	E603FL07	JPS KOHALA	AMR	OK	31.03.2023	Category 5-UPS				2047134	900-450/577/1-1	3,398	NA	Director/D	
B.5261	North	KAPURTHALA	11KV	DS CITY DIVN. KAPURTH	DS/0 KALA SINGIANA	E603FL03	NARAYANPUR	AMR	OK	31.03.2023	AP 3Phase 3Wire				8223675	900-450/577/1-1	3,415	NA	Director/D	
B.5262	North	KAPURTHALA	11KV	DS CITY DIVN. KAPURTH	DS/0 KALA SINGIANA	D634FL16	NAWA PIND	AMR	OK	31.03.2023	AP 3Phase 3Wire				8223673	900-450/577/1-1	4,648	NA	Director/D	
B.5263	North	KAPURTHALA	11KV	DS CITY DIVN. KAPURTH	DS/0 KALA SINGIANA	E603FL15	Jallowal	NON AMR	OK	31.03.2023	Category 1				73162922	900-450/577/1-1	5,111	NA	Director/D	
B.5264	North	KAPURTHALA	11KV	DS CITY DIVN. KAPURTH	DS/0 KALA SINGIANA	E603FL01	URBAN KALA SANGHAN	AMR	OK	31.03.2023	Category 1				1114529	900-450/577/1-1	7,682	NA	Director/D	
B.5265	North	KAPURTHALA	11KV	DS CITY DIVN. KAPURTH	DS/0 KALA SINGIANA	D615FL17	SHAHPUR	AMR	OK	31.03.2023	AP 3Phase 3Wire				73170562	1200-600/5	2,048	NA	Director/D	
B.5266	North	KAPURTHALA	11KV	DS CITY DIVN. KAPURTH	DS/0 KALA SINGIANA	D615FL03	KADHI KHROSPUR	AMR	OK	31.03.2023	AP 3Phase 3Wire				8223711	900-450/577/1-1	2,361	NA	Director/D	
B.5267	North	KAPURTHALA	11KV	DS CITY DIVN. KAPURTH	DS/0 KALA SINGIANA	D615FL08	BAHDAL	NON AMR	OK	31.03.2023	AP 3Phase 3Wire				00777379	1200-600/5	2,682	NA	Director/D	
B.5268	North	KAPURTHALA	11KV	DS CITY DIVN. KAPURTH	DS/0 KALA SINGIANA	E602FL09	BHETA AP	AMR	OK	31.03.2023	AP 3Phase 3Wire				11117026	900-450/577/1-1	1,468	NA	Director/D	
B.5269	North	KAPURTHALA	11KV	DS CITY DIVN. KAPURTH	DS/0 KALA SINGIANA	D622FL01	Desarpur Branch	AMR	OK	31.03.2023	AP 3Phase 3Wire				8223688	900-450/577/1-1	1,553	NA	Director/D	
B.5270	North	KAPURTHALA	11KV	DS CITY DIVN. KAPURTH	DS/0 KALA SINGIANA	E602FL04	KHANOWAL	AMR	OK	31.03.2023	AP 3Phase 3Wire				8223688	900-450/577/1-1	1,678	NA	Director/D	
B.5271	North	KAPURTHALA																		

S.No	Zone	Circle	Voltage Level (kVA)	Division (kVA)	Sub-Division (kVA)	Feeder ID	Feeder Name	Feeder Metering Status (Metered/unmetered/AMR/AMI)	Status of Meter (Functional/Non-Functional)	Metering Date (Date of last actual meter reading/communication)	Feeder Type (Agr/Industrial/Mixed)	Status of Communication			Period from 01.04.2021 to 31.03.2022			Sales	Remarks (Source of data)
												% data received through automatically if feeder AMR/AMI	Number of hours when meter was unable to communicate in overall	Total Number of hours in the period	Meter S.No	CT/PT ratio	Import (kWh)		
B.5305	North	KAPURTHALA	11kV	DS CITY DIVN. KAPURTH	DS S/D KHERA MANDIR	D615FL01	UPS KHUSORUPUR	AMR	OK	31.03.2023	Category 5-UPS				6675540	900-450/577/1-1-1	5.985	NA	Director/D
B.5306	North	KAPURTHALA	11kV	DS CITY DIVN. KAPURTH	DS S/D KHERA MANDIR	D615FL13	UPS KULLAR	AMR	OK	31.03.2023	Category 5-UPS				65637VG	1200/600/5	6.441	NA	Director/D
B.5307	North	KAPURTHALA	11kV	DS CITY DIVN. KAPURTH	DS S/D KHERA MANDIR	D645FL02	Togbarwal	AMR	OK	31.03.2023	AP 3Phase 3Wire				1	900-450/577/1-1-1	0.439	NA	Director/D
B.5308	North	KAPURTHALA	11kV	DS CITY DIVN. KAPURTH	DS S/D KHERA MANDIR	D645FL03	Be Sahib	AMR	OK	31.03.2023	AP 3Phase 3Wire				PV003091	900-450/577/1-1-1	1.250	NA	Director/D
B.5309	North	KAPURTHALA	11kV	DS CITY DIVN. KAPURTH	DS S/D KHERA MANDIR	D645FL07	BHANDALANGA	AMR	OK	31.03.2023	AP 3Phase 3Wire				1	900-450/577/1-1-1	1.629	NA	Director/D
B.5310	North	KAPURTHALA	11kV	DS CITY DIVN. KAPURTH	DS S/D KHERA MANDIR	D645FL04	GARHGANA SAHIB	AMR	OK	31.03.2023	AP 3Phase 3Wire				1	900-450/577/1-1-1	2.270	NA	Director/D
B.5311	North	KAPURTHALA	11kV	DS CITY DIVN. KAPURTH	DS S/D KHERA MANDIR	D645FL08	GOBINDGARH	AMR	OK	31.03.2023	AP 3Phase 3Wire				1	900-450/577/1-1-1	2.382	NA	Director/D
B.5312	North	KAPURTHALA	11kV	DS CITY DIVN. KAPURTH	DS S/D KHERA MANDIR	D645FL05	Thigil	AMR	OK	31.03.2023	AP 3Phase 3Wire				PV003138	900-450/577/1-1-1	2.427	NA	Director/D
B.5313	North	KAPURTHALA	11kV	DS CITY DIVN. KAPURTH	DS S/D KHERA MANDIR	D645FL01	Sidhwan Dona	AMR	OK	31.03.2023	Category 1				PV003091	900-450/577/1-1-1	4.078	NA	Director/D
B.5314	North	KAPURTHALA	11kV	DS CITY DIVN. KAPURTH	DS S/D KHERA MANDIR	D645FL06	UPS Syala	AMR	OK	31.03.2023	Category 5-UPS				PV004288	900-450/577/1-1-1	6.026	NA	Director/D
B.5315	North	KAPURTHALA	11kV	DS CITY DIVN. KAPURTH	DS S/D KHERA MANDIR	E608FL10	SIYALA	AMR	OK	31.03.2023	AP 3Phase 3Wire				8222657	900-450/5	2.039	NA	Director/D
B.5316	North	KAPURTHALA	11kV	DS CITY DIVN. NAKODAR	S/D LOHIAN	E620FL01	Kotli Kambaj	AMR	OK	31.03.2023	AP 3Phase 3Wire				X0777241	1200/577/1-1-1	1.902	NA	Director/D
B.5317	North	KAPURTHALA	11kV	DS CITY DIVN. NAKODAR	S/D LOHIAN	E608FL03	KANG KHURD	NON AMR	OK	31.03.2023	AP 3Phase 3Wire				X0777499	1200/577/1-1-1	2.042	NA	Director/D
B.5318	North	KAPURTHALA	11kV	DS CITY DIVN. NAKODAR	S/D LOHIAN	D609FL10	PHULL	AMR	OK	31.03.2023	AP 3Phase 3Wire				2068385	300-150/5	0.982	NA	Director/D
B.5319	North	KAPURTHALA	11kV	DS CITY DIVN. NAKODAR	S/D LOHIAN	D609FL03	TURNA	AMR	OK	31.03.2023	AP 3Phase 3Wire				9140675	200-100/5-5	1.466	NA	Director/D
B.5320	North	KAPURTHALA	11kV	DS CITY DIVN. NAKODAR	S/D LOHIAN	D609FL04	KANG	AMR	OK	31.03.2023	AP 3Phase 3Wire				X0777239	200-100/5-5	1.572	NA	Director/D
B.5321	North	KAPURTHALA	11kV	DS CITY DIVN. NAKODAR	S/D LOHIAN	D609FL11	RAWAL	AMR	OK	31.03.2023	AP 3Phase 3Wire				9154065	200-100/5-5	1.681	NA	Director/D
B.5322	North	KAPURTHALA	11kV	DS CITY DIVN. NAKODAR	S/D LOHIAN	D609FL07	NASIRPUR	AMR	OK	31.03.2023	AP 3Phase 3Wire				8223856	200-100/5-5	1.819	NA	Director/D
B.5323	North	KAPURTHALA	11kV	DS CITY DIVN. NAKODAR	S/D LOHIAN	D609FL02	SIDHPUR	AMR	OK	31.03.2023	AP 3Phase 3Wire				8223240	300-150/5	1.949	NA	Director/D
B.5324	North	KAPURTHALA	11kV	DS CITY DIVN. NAKODAR	S/D LOHIAN	D609FL05	TADHPUR	AMR	OK	31.03.2023	AP 3Phase 3Wire				1	200-100/5-5	2.191	NA	Director/D
B.5325	North	KAPURTHALA	11kV	DS CITY DIVN. NAKODAR	S/D LOHIAN	D609FL01	BADI	AMR	OK	31.03.2023	AP 3Phase 3Wire				8223417	300-150/5	2.252	NA	Director/D
B.5326	North	KAPURTHALA	11kV	DS CITY DIVN. NAKODAR	S/D LOHIAN	D609FL15	Guru Nanak colony	AMR	OK	31.03.2023	Category 1				9154065	300-150/5	3.030	NA	Director/D
B.5327	North	KAPURTHALA	11kV	DS CITY DIVN. NAKODAR	S/D LOHIAN	D609FL12	Baull Sahib	AMR	OK	31.03.2023	Category 1				9140675	300-150/5	3.951	NA	Director/D
B.5328	North	KAPURTHALA	11kV	DS CITY DIVN. NAKODAR	S/D LOHIAN	D609FL16	Shahjahanpur	AMR	OK	31.03.2023	Category 5-UPS				11060906	300-150/5	5.316	NA	Director/D
B.5329	North	KAPURTHALA	11kV	DS CITY DIVN. NAKODAR	S/D LOHIAN	D609FL09	UPS DALLA	AMR	OK	31.03.2023	Category 5-UPS				11051963	300-150/5	5.833	NA	Director/D
B.5330	North	KAPURTHALA	11kV	DS CITY DIVN. NAKODAR	S/D LOHIAN	D609FL06	UPS NAL	NON AMR	OK	31.03.2023	Category 5-UPS				9154119	200-100/5-5	7.190	NA	Director/D
B.5331	North	KAPURTHALA	11kV	DS CITY DIVN. NAKODAR	S/D LOHIAN	D609FL08	URBAN LOHIAN	NON AMR	OK	31.03.2023	Category 1				11060906	200-100/5-5	11.663	NA	Director/D
B.5332	North	KAPURTHALA	11kV	DS CITY DIVN. NAKODAR	S/D LOHIAN	D610FL01	URBAN MEHRAWALA	AMR	OK	31.03.2023	Category 1				9544708	1200-600/5	0.864	NA	Director/D
B.5333	North	KAPURTHALA	11kV	DS CITY DIVN. NAKODAR	S/D LOHIAN	D610FL07	JAMSHER	AMR	OK	31.03.2023	AP 3Phase 3Wire				9140894	1200-600/5	1.197	NA	Director/D
B.5334	North	KAPURTHALA	11kV	DS CITY DIVN. NAKODAR	S/D LOHIAN	D610FL06	MANDALA	AMR	OK	31.03.2023	AP 3Phase 3Wire				9140895	1200-600/5	1.361	NA	Director/D
B.5335	North	KAPURTHALA	11kV	DS CITY DIVN. NAKODAR	S/D LOHIAN	D610FL04	MUNDI CHOLLIAN	AMR	OK	31.03.2023	AP 3Phase 3Wire				9140641	1200-800/5	1.483	NA	Director/D
B.5336	North	KAPURTHALA	11kV	DS CITY DIVN. NAKODAR	S/D LOHIAN	D610FL03	RHAISEWAL	AMR	OK	31.03.2023	AP 3Phase 3Wire				8223055	1200-600/5	1.599	NA	Director/D
B.5337	North	KAPURTHALA	11kV	DS CITY DIVN. NAKODAR	S/D LOHIAN	D610FL16	mandi kaku	AMR	OK	31.03.2023	AP 3Phase 3Wire				PV004278	1200-600/5	1.580	NA	Director/D
B.5338	North	KAPURTHALA	11kV	DS CITY DIVN. NAKODAR	S/D LOHIAN	D610FL02	JANIA	NON AMR	OK	31.03.2023	AP 3Phase 3Wire				8223051	1200-600/5	1.587	NA	Director/D
B.5339	North	KAPURTHALA	11kV	DS CITY DIVN. NAKODAR	S/D LOHIAN	D610FL12	Gatta Mundi Kasso	AMR	OK	31.03.2023	AP 3Phase 3Wire				12527333	1200-600/5	1.842	NA	Director/D
B.5340	North	KAPURTHALA	11kV	DS CITY DIVN. NAKODAR	S/D LOHIAN	D610FL13	RAWAL	AMR	OK	31.03.2023	AP 3Phase 3Wire				13190569	1200-600/5	1.848	NA	Director/D
B.5341	North	KAPURTHALA	11kV	DS CITY DIVN. NAKODAR	S/D LOHIAN	D610FL05	JALPUR KHURD	AMR	OK	31.03.2023	AP 3Phase 3Wire				9140801	1200-600/5	2.246	NA	Director/D
B.5342	North	KAPURTHALA	11kV	DS CITY DIVN. NAKODAR	S/D LOHIAN	D610FL14	UPS KOTHA	NON AMR	OK	31.03.2023	Category 5-UPS				43177	1200-600/5	2.464	NA	Director/D
B.5343	North	KAPURTHALA	11kV	DS CITY DIVN. NAKODAR	S/D LOHIAN	D610FL09	UPS CHAK WADALA	AMR	OK	31.03.2023	Category 5-UPS				2068616	1200-600/5	7.178	NA	Director/D
B.5344	North	KAPURTHALA	11kV	DS CITY DIVN. NAKODAR	S/D MALSIAN	D602FL07	Bagpur	AMR	OK	31.03.2023	AP 3Phase 3Wire				15193770	900-450/577/1-1-1	0.375	NA	Director/D
B.5345	North	KAPURTHALA	11kV	DS CITY DIVN. NAKODAR	S/D MALSIAN	D602FL06	Bhodpur	AMR	OK	31.03.2023	AP 3Phase 3Wire				15192344	900-450/577/1-1-1	1.873	NA	Director/D
B.5346	North	KAPURTHALA	11kV	DS CITY DIVN. NAKODAR	S/D MALSIAN	D602FL03	Buller	AMR	OK	31.03.2023	AP 3Phase 3Wire				X0777500	900-450/577/1-1-1	1.887	NA	Director/D
B.5347	North	KAPURTHALA	11kV	DS CITY DIVN. NAKODAR	S/D MALSIAN	D602FL11	Rawan Killa	AMR	OK	31.03.2023	AP 3Phase 3Wire				13190490	900-450/577/1-1-1	1.929	NA	Director/D
B.5348	North	KAPURTHALA	11kV	DS CITY DIVN. NAKODAR	S/D MALSIAN	D641FL02	Khanpur	AMR	OK	31.03.2023	AP 3Phase 3Wire				15192342	900-450/577/1-1-1	1.667	NA	Director/D
B.5349	North	KAPURTHALA	11kV	DS CITY DIVN. NAKODAR	S/D MALSIAN	D641FL05	Saharwal	AMR	OK	31.03.2023	AP 3Phase 3Wire				1	900-450/577/1-1-1	1.933	NA	Director/D
B.5350	North	KAPURTHALA	11kV	DS CITY DIVN. NAKODAR	S/D MALSIAN	D641FL06	Hunda Feeder	AMR	OK	31.03.2023	AP 3Phase 3Wire				1	900-450/577/1-1-1	2.273	NA	Director/D
B.5351	North	KAPURTHALA	11kV	DS CITY DIVN. NAKODAR	S/D MALSIAN	D641FL04	Gill	AMR	OK	31.03.2023	AP 3Phase 3Wire				1	900-450/577/1-1-1	2.388	NA	Director/D
B.5352	North	KAPURTHALA	11kV	DS CITY DIVN. NAKODAR	S/D MALSIAN	D641FL03	Bhawalah	AMR	OK	31.03.2023	AP 3Phase 3Wire				1	900-450/577/1-1-1	2.408	NA	Director/D
B.5353	North	KAPURTHALA	11kV	DS CITY DIVN. NAKODAR	S/D MALSIAN	D641FL01	UPS Seowal	AMR	OK	31.03.2023	Category 5-UPS				15192299	900-450/577/1-1-1	6.154	NA	Director/D
B.5354	North	KAPURTHALA	11kV	DS CITY DIVN. NAKODAR	S/D MALSIAN	D620FL12	Makhi	AMR	OK	31.03.2023	AP 3Phase 3Wire				Y0198074	1200/577/1-1-1	0.793	NA	Director/D
B.5355	North	KAPURTHALA	11kV	DS CITY DIVN. NAKODAR	S/D MALSIAN	D603FL11	UPS KACHI SARAI KHAS	AMR	OK	31.03.2023	Category 5-UPS				2067723	900-450/5	1.331	NA	Director/D
B.5356	North	KAPURTHALA	11kV	DS CITY DIVN. NAKODAR	S/D MALSIAN	D603FL06	Chawinda	AMR	OK	31.03.2023	AP 3Phase 3Wire				9154246	1200-600/5	1.459	NA	Director/D
B.5357	North	KAPURTHALA	11kV	DS CITY DIVN. NAKODAR	S/D MALSIAN	D603FL08	Gill	AMR	OK	31.03.2023	AP 3Phase 3Wire				11117270	900-450/5	1.468	NA	Director/D
B.5358	North	KAPURTHALA	11kV	DS CITY DIVN. NAKODAR	S/D MALSIAN	D603FL07	Bagpur	AMR	OK	31.03.2023	AP 3Phase 3Wire				91544117	1200-600/5	1.540	NA	Director/D
B.5359	North	KAPURTHALA	11kV	DS CITY DIVN. NAKODAR	S/D MALSIAN	D603FL14	Industrial Feeder	NON AMR	OK	31.03.2023	Category 2				1	1200-600/5	1.657	NA	Director/D
B.5360	North	KAPURTHALA	11kV	DS CITY DIVN. NAKODAR	S/D MALSIAN	D603FL15	Eswal	NON AMR	OK	31.03.2023	AP 3Phase 3Wire				9957991	900-450/5	1.919	NA	Director/D
B.5361	North	KAPURTHALA	11kV	DS CITY DIVN. NAKODAR	S/D MALSIAN	D603FL10	Darbar Paper Mill	AMR	OK	31.03.2023	Category 4				12491941	1200-600/5	2.221	NA	Director/D
B.5362	North	KAPURTHALA	11kV	DS CITY DIVN. NAKODAR	S/D MALSIAN	D603FL04	Kotli Gagan	NON AMR	OK	31.03.2023	AP 3Phase 3Wire				11117139	900-450/5	2.270	NA	Director/D
B.5363	North	KAPURTHALA	11kV	DS CITY DIVN. NAKODAR	S/D MALSIAN	D603FL13	Rajpur Station	AMR	OK	31.03.2023	AP 3Phase 3Wire				9186106	1200-600/5	2.280	NA	Director/D
B.5364	North	KAPURTHALA	11kV	DS CITY DIVN. NAKODAR	S/D MALSIAN	D603FL16	UPS MALLIWAL	AMR	OK	31.03.2023	Category 5-UPS				1	900-450/577/1-1-1	2.301	NA	Director/D
B.5365	North	KAPURTHALA	11kV	DS CITY DIVN. NAKODAR	S/D MALSIAN	D603FL01	Kangna	AMR	OK	31.03.2023	AP 3Phase 3Wire				11117313	900-450/5	2.356	NA	Director/D
B.5366	North	KAPURTHALA	11kV	DS CITY DIVN. NAKODAR	S/D MALSIAN	D603FL05	nawalpur	AMR	OK	31.03.2023	AP 3Phase 3Wire				11117147	900-450/5	2.540	NA	Director/D
B.5367	North	KAPURTHALA	11kV	DS CITY DIVN. NAKODAR	S/D MALSIAN	D603FL09	UPS Kotli	AMR	OK	31.03.2023	Category 5-UPS				9154358	900-450/5	3.965	NA	Director/D
B.5368	North	KAPURTHALA	11kV	DS CITY DIVN. NAKODAR	S/D MALSIAN	D603FL02	URBAN Malisain	NON AMR	OK	31.03.2023	Category 1				9153619	1200-800/5	5.347	NA	Director/D
B.5369	North	KAPURTHALA	11kV	DS CITY DIVN. NAKODAR	S/D MALSIAN	D603FL08	Shahjahanpur	AMR	OK	31.03.2023	AP 3Phase 3Wire				2066564	900-450/			

S.No	Zone	Circle	Voltage Level (kVA)	Division (kVA)	Sub-Division (kVA)	Feeder ID	Feeder Name	Feeder Metering Status (Metered/unmetered/AM/AMR)	Status of Meter (Functional/Non-Functional)	Metering Date (Date of last actual meter reading/communication)	Feeder Type (Agr/Industrial/Mixed)	Status of Communication			Period from 01.04.2021 to 31.03.2022				Sales	Remarks (Source of data)
												% Data received through automatically if feeder AMR/AM	Number of hours when meter was unable to communicate in week	Total Number of hours in the period	Meter S.No	CT/PT ratio	Import (kWh)	Export (kWh)		
B.5402	North	KAPURTHALA	11KV	DS CITY DIVN. NAKODAR	S/D MEHATPUR	D605F102	Ramuwal	AMR	OK	31.03.2023	AP 3Phase 3Wire				8223756	1200/577/1-1-1	5.087	NA	Director/D	
B.5403	North	KAPURTHALA	11KV	DS CITY DIVN. NAKODAR	S/D MEHATPUR	D605F112	Mohena	AMR	OK	31.03.2023	AP 3Phase 3Wire				8223760	900-450/577/1-1-1	5.179	NA	Director/D	
B.5404	North	KAPURTHALA	11KV	DS CITY DIVN. NAKODAR	S/D MEHATPUR	D605F106	URBAN Mehatpur	AMR	OK	31.03.2023	Category 1				7338445	900-450/577/1-1-1	6.762	NA	Director/D	
B.5405	North	KAPURTHALA	11KV	DS CITY DIVN. NAKODAR	S/D MEHATPUR	D605F116	Industrial Area	NON AMR	OK	31.03.2023	Category 1				1300777/1-1-1		8.583	NA	Director/D	
B.5406	North	KAPURTHALA	11KV	DS CITY DIVN. NAKODAR	S/D MEHATPUR	D605F109	UPS Aitani	NON AMR	OK	31.03.2023	Category 5-UPS				11117322	900-450/577/1-1-1	11.648	NA	Director/D	
B.5407	North	KAPURTHALA	11KV	DS CITY DIVN. NAKODAR	S/D MEHATPUR	D614F104	URBAN Mersampur	AMR	OK	31.03.2023	Category 1				10281291	900-450/577/1-1-1	0.818	NA	Director/D	
B.5408	North	KAPURTHALA	11KV	DS CITY DIVN. NAKODAR	S/D MEHATPUR	D614F109	Rajpur	AMR	OK	31.03.2023	AP 3Phase 3Wire				8223278	900-450/577/1-1-1	1.513	NA	Director/D	
B.5409	North	KAPURTHALA	11KV	DS CITY DIVN. NAKODAR	S/D MEHATPUR	D614F102	Bangul Raian	AMR	OK	31.03.2023	AP 3Phase 3Wire				8223279	900-450/577/1-1-1	1.866	NA	Director/D	
B.5410	North	KAPURTHALA	11KV	DS CITY DIVN. NAKODAR	S/D MEHATPUR	D614F111	Channa	AMR	OK	31.03.2023	AP 3Phase 3Wire				1	900-450/577/1-1-1	1.907	NA	Director/D	
B.5411	North	KAPURTHALA	11KV	DS CITY DIVN. NAKODAR	S/D MEHATPUR	D614F101	Yehran	AMR	OK	31.03.2023	AP 3Phase 3Wire				9141123	900-450/577/1-1-1	2.377	NA	Director/D	
B.5412	North	KAPURTHALA	11KV	DS CITY DIVN. NAKODAR	S/D MEHATPUR	D614F105	Aitani	AMR	OK	31.03.2023	AP 3Phase 3Wire				9141122	900-450/577/1-1-1	2.381	NA	Director/D	
B.5413	North	KAPURTHALA	11KV	DS CITY DIVN. NAKODAR	S/D MEHATPUR	D614F112	Gorsian Peeran	AMR	OK	31.03.2023	AP 3Phase 3Wire				1	900-450/577/1-1-1	2.399	NA	Director/D	
B.5414	North	KAPURTHALA	11KV	DS CITY DIVN. NAKODAR	S/D MEHATPUR	D614F106	Awan Khata	AMR	OK	31.03.2023	AP 3Phase 3Wire				9141124	900-450/577/1-1-1	2.534	NA	Director/D	
B.5415	North	KAPURTHALA	11KV	DS CITY DIVN. NAKODAR	S/D MEHATPUR	D614F107	Madeypur	NON AMR	OK	31.03.2023	AP 3Phase 3Wire				9140968	900-450/577/1-1-1	2.562	NA	Director/D	
B.5416	North	KAPURTHALA	11KV	DS CITY DIVN. NAKODAR	S/D MEHATPUR	D614F108	UPS Kaimwala	NON AMR	OK	31.03.2023	Category 5-UPS				6607224	900-450/577/1-1-1	7.993	NA	Director/D	
B.5417	North	KAPURTHALA	11KV	DS CITY DIVN. NAKODAR	S/D MEHATPUR	D605F101	UPS TANDA AURA	AMR	OK	31.03.2023	Category 5-UPS				10282920	900-450/577/1-1-1	8.057	NA	Director/D	
B.5418	North	KAPURTHALA	11KV	DS CITY DIVN. NAKODAR	S/D MEHATPUR	D642F104	AITANI BET	AMR	OK	31.03.2023	AP 3Phase 3Wire				16194314	1200/577/1-1-1	1.221	NA	Director/D	
B.5419	North	KAPURTHALA	11KV	DS CITY DIVN. NAKODAR	S/D MEHATPUR	D642F105	11 KV Janta Nagar	AMR	OK	31.03.2023	Category 5-UPS				1	1200/577/1-1-1	3.193	NA	Director/D	
B.5420	North	KAPURTHALA	11KV	DS CITY DIVN. NAKODAR	S/D MEHATPUR	D607F108	Khurafur	AMR	OK	31.03.2023	AP 3Phase 3Wire				BP9094377	900-450/577/1-1-1	1.785	NA	Director/D	
B.5421	North	KAPURTHALA	11KV	DS CITY DIVN. NAKODAR	S/D MEHATPUR	D607F114	Luhgirth	AMR	OK	31.03.2023	AP 3Phase 3Wire				37523	900-450/577/1-1-1	2.291	NA	Director/D	
B.5422	North	KAPURTHALA	11KV	DS CITY DIVN. NAKODAR	S/D PARIJAN	D607F102	MES	AMR	OK	31.03.2023	Category 1				37572	900-450/577/1-1-1	0.111	NA	Director/D	
B.5423	North	KAPURTHALA	11KV	DS CITY DIVN. NAKODAR	S/D PARIJAN	D607F114	DHARMWAL	AMR	OK	31.03.2023	AP 3Phase 3Wire				73194763	900-450/577/1-1-1	1.353	NA	Director/D	
B.5424	North	KAPURTHALA	11KV	DS CITY DIVN. NAKODAR	S/D PARIJAN	D607F111	UDHOWAL	AMR	OK	31.03.2023	UD HOWAL				73161722	900-450/577/1-1-1	1.367	NA	Director/D	
B.5425	North	KAPURTHALA	11KV	DS CITY DIVN. NAKODAR	S/D PARIJAN	D607F109	SANDA	AMR	OK	31.03.2023	AP 3Phase 3Wire				139585	900-450/577/1-1-1	1.538	NA	Director/D	
B.5426	North	KAPURTHALA	11KV	DS CITY DIVN. NAKODAR	S/D PARIJAN	D607F113	BUREWAL	AMR	OK	31.03.2023	AP 3Phase 3Wire				73161712	900-450/577/1-1-1	1.738	NA	Director/D	
B.5427	North	KAPURTHALA	11KV	DS CITY DIVN. NAKODAR	S/D PARIJAN	D607F115	Gehran	AMR	OK	31.03.2023	AP 3Phase 3Wire				73192256	900-450/577/1-1-1	1.758	NA	Director/D	
B.5428	North	KAPURTHALA	11KV	DS CITY DIVN. NAKODAR	S/D PARIJAN	D607F110	URBAN Parjjan Kalan	AMR	OK	31.03.2023	Category 1				73130048	900-450/577/1-1-1	2.027	NA	Director/D	
B.5429	North	KAPURTHALA	11KV	DS CITY DIVN. NAKODAR	S/D PARIJAN	D607F101	Bulanda	AMR	OK	31.03.2023	AP 3Phase 3Wire				21001/6/31	900-450/577/1-1-1	2.033	NA	Director/D	
B.5430	North	KAPURTHALA	11KV	DS CITY DIVN. NAKODAR	S/D PARIJAN	D607F103	Raunta	AMR	OK	31.03.2023	AP 3Phase 3Wire				BP9094386	900-450/577/1-1-1	2.037	NA	Director/D	
B.5431	North	KAPURTHALA	11KV	DS CITY DIVN. NAKODAR	S/D PARIJAN	D607F105	Danewal	AMR	OK	31.03.2023	AP 3Phase 3Wire				45514	900-450/577/1-1-1	2.118	NA	Director/D	
B.5432	North	KAPURTHALA	11KV	DS CITY DIVN. NAKODAR	S/D PARIJAN	D607F106	AKBARPUR	AMR	OK	31.03.2023	AP 3Phase 3Wire				45999	900-450/577/1-1-1	2.288	NA	Director/D	
B.5433	North	KAPURTHALA	11KV	DS CITY DIVN. NAKODAR	S/D PARIJAN	D607F116	Bulandpur	AMR	OK	31.03.2023	Category 5-UPS				73194941	900-450/577/1-1-1	3.126	NA	Director/D	
B.5434	North	KAPURTHALA	11KV	DS CITY DIVN. NAKODAR	S/D PARIJAN	D607F107	UPS Sohail Jagir	AMR	OK	31.03.2023	Category 5-UPS				45986	900-450/577/1-1-1	6.399	NA	Director/D	
B.5435	North	KAPURTHALA	11KV	DS CITY DIVN. NAKODAR	S/D PARIJAN	D607F104	UPS Dhuggar	AMR	OK	31.03.2023	Category 1				310770010/B/18	900-450/577/1-1-1	9.563	NA	Director/D	
B.5436	North	KAPURTHALA	11KV	DS CITY DIVN. NAKODAR	S/D SHAHKOT	D607F102	Saikhpur	AMR	OK	31.03.2023	AP 3Phase 3Wire				9140418	900-450/577/1-1-1	1.502	NA	Director/D	
B.5437	North	KAPURTHALA	11KV	DS CITY DIVN. NAKODAR	S/D SHAHKOT	D607F110	Talwani Sanghera	AMR	OK	31.03.2023	AP 3Phase 3Wire				10282869	900-450/577/1-1-1	2.461	NA	Director/D	
B.5438	North	KAPURTHALA	11KV	DS CITY DIVN. NAKODAR	S/D SHAHKOT	L1110607	Raj Khata tandwani	AMR	OK	31.03.2023	Category 5-UPS				10282868	900-450/577/1-1-1	3.915	NA	Director/D	
B.5439	North	KAPURTHALA	11KV	DS CITY DIVN. NAKODAR	S/D SHAHKOT	D620F114	Ghana	AMR	OK	31.03.2023	AP 3Phase 3Wire				PV003897	1200/577/1-1-1	0.060	NA	Director/D	
B.5440	North	KAPURTHALA	11KV	DS CITY DIVN. NAKODAR	S/D SHAHKOT	D620F116	Ismaelgar	NON AMR	OK	31.03.2023	AP 3Phase 3Wire				PV003898	1200/577/1-1-1	0.437	NA	Director/D	
B.5441	North	KAPURTHALA	11KV	DS CITY DIVN. NAKODAR	S/D SHAHKOT	E608F111	UPS Pipli	AMR	OK	31.03.2023	Category 5-UPS				742808	1200/577/1-1-1	0.547	NA	Director/D	
B.5442	North	KAPURTHALA	11KV	DS CITY DIVN. NAKODAR	S/D SHAHKOT	E608F101	MOHRWAL	AMR	OK	31.03.2023	AP 3Phase 3Wire				8223519	1200/577/1-1-1	0.658	NA	Director/D	
B.5443	North	KAPURTHALA	11KV	DS CITY DIVN. NAKODAR	S/D SHAHKOT	D620F115	Hevra	AMR	OK	31.03.2023	AP 3Phase 3Wire				PV003941	1200/577/1-1-1	0.979	NA	Director/D	
B.5444	North	KAPURTHALA	11KV	DS CITY DIVN. NAKODAR	S/D SHAHKOT	E608F105	Hevra	AMR	OK	31.03.2023	AP 3Phase 3Wire				9140783	1200/577/1-1-1	1.943	NA	Director/D	
B.5445	North	KAPURTHALA	11KV	DS CITY DIVN. NAKODAR	S/D SHAHKOT	D620F111	Fatehgar Bhagwan	AMR	OK	31.03.2023	AP 3Phase 3Wire				9140784	1200/577/1-1-1	1.089	NA	Director/D	
B.5446	North	KAPURTHALA	11KV	DS CITY DIVN. NAKODAR	S/D SHAHKOT	E608F106	Miani	AMR	OK	31.03.2023	Category 3Wire				9140785	1200/577/1-1-1	1.676	NA	Director/D	
B.5447	North	KAPURTHALA	11KV	DS CITY DIVN. NAKODAR	S/D SHAHKOT	E608F107	CHAK GADAUPUR	AMR	OK	31.03.2023	AP 3Phase 3Wire				8223227	1200/577/1-1-1	1.791	NA	Director/D	
B.5448	North	KAPURTHALA	11KV	DS CITY DIVN. NAKODAR	S/D SHAHKOT	E608F120	Raewal	AMR	OK	31.03.2023	AP 3Phase 3Wire				9140781	1200/577/1-1-1	1.998	NA	Director/D	
B.5449	North	KAPURTHALA	11KV	DS CITY DIVN. NAKODAR	S/D SHAHKOT	E608F108	Raewal	AMR	OK	31.03.2023	AP 3Phase 3Wire				82077885	1200/577/1-1-1	2.028	NA	Director/D	
B.5450	North	KAPURTHALA	11KV	DS CITY DIVN. NAKODAR	S/D SHAHKOT	D620F113	UPS Poonia	NON AMR	OK	31.03.2023	Category 5-UPS				PV004254	1200/577/1-1-1	3.197	NA	Director/D	
B.5451	North	KAPURTHALA	11KV	DS CITY DIVN. NAKODAR	S/D SHAHKOT	E608F108	UPS Nawa Pind Akalan	AMR	OK	31.03.2023	Category 5-UPS				7042921	1200/577/1-1-1	6.556	NA	Director/D	
B.5452	North	KAPURTHALA	11KV	DS CITY DIVN. NAKODAR	S/D SHAHKOT	D616F110	Pato Khurd	AMR	OK	31.03.2023	AP 3Phase 3Wire				15194706	900-450/577/1-1-1	0.581	NA	Director/D	
B.5453	North	KAPURTHALA	11KV	DS CITY DIVN. NAKODAR	S/D SHAHKOT	D616F103	Miyawal	AMR	OK	31.03.2023	AP 3Phase 3Wire				7336473	1200-600/5	1.019	NA	Director/D	
B.5454	North	KAPURTHALA	11KV	DS CITY DIVN. NAKODAR	S/D SHAHKOT	D616F111	TINDWAL	AMR	OK	31.03.2023	AP 3Phase 3Wire				1	900-450/577/1-1-1	1.120	NA	Director/D	
B.5455	North	KAPURTHALA	11KV	DS CITY DIVN. NAKODAR	S/D SHAHKOT	D616F111	Hevra	AMR	OK	31.03.2023	AP 3Phase 3Wire				1	900-450/577/1-1-1	1.368	NA	Director/D	
B.5456	North	KAPURTHALA	11KV	DS CITY DIVN. NAKODAR	S/D SHAHKOT	D616F107	Talwandi Bostan	AMR	OK	31.03.2023	AP 3Phase 3Wire				15193851	1200-600/5	1.448	NA	Director/D	
B.5457	North	KAPURTHALA	11KV	DS CITY DIVN. NAKODAR	S/D SHAHKOT	D616F106	Rame	NON AMR	OK	31.03.2023	AP 3Phase 3Wire				8077502	1200-600/5	1.552	NA	Director/D	
B.5458	North	KAPURTHALA	11KV	DS CITY DIVN. NAKODAR	S/D SHAHKOT	D616F101	UPS Kohar Khurd	AMR	OK	31.03.2023	Category 5-UPS				7424110	1200-600/5	1.669	NA	Director/D	

S.No	Zone	Circle	Voltage Level (kVA)	Division (kVA)	Sub-Division (kVA)	Feeder ID	Feeder Name	Feeder Metering Status (Metered/unmetered/AMR/AMI)	Status of Meter (Functional/Non-Functional)	Metering Date (Date of last actual meter reading/communication)	Feeder Type (Agr/Industrial/Mixed)	Status of Communication			Period from 01.04.2021 to 31.03.2022				Sales	Remarks (Source of data)
												% data received through automatically if feeder AMR/AMI	Number of hours when meter was unable to communicate in week	Total Number of hours in the period	Meter S.No	CT/PT ratio	Import (kWh)	Export (kWh)		
B.5499	North	KAPURTHALA	11KV	DS DIVN. KARTARPUR	DS S/D BHOLOTH	0626FL11	METLA	AMR	OK	31.03.2023	Category 5-UPS				7030224	900-450/577/1-1-1	0.000	NA	Director/D	
B.5500	North	KAPURTHALA	11KV	DS DIVN. KARTARPUR	DS S/D BHOLOTH	0626FL08	BAAGWANPUR	AMR	OK	31.03.2023	AP 3Phase 3Wire				2047137	900-450/577/1-1-1	1.433	NA	Director/D	
B.5501	North	KAPURTHALA	11KV	DS DIVN. KARTARPUR	DS S/D BHOLOTH	0626FL06	KAUPUR	AMR	OK	31.03.2023	AP 3Phase 3Wire				8223531	900-450/577/1-1-1	1.583	NA	Director/D	
B.5502	North	KAPURTHALA	11KV	DS DIVN. KARTARPUR	DS S/D BHOLOTH	0626FL14	SALAKATPUR	AMR	OK	31.03.2023	Category 1				8223384	900-450/577/1-1-1	1.643	NA	Director/D	
B.5503	North	KAPURTHALA	11KV	DS DIVN. KARTARPUR	DS S/D BHOLOTH	0626FL12	JOGINDER NAGAR	AMR	OK	31.03.2023	AP 3Phase 3Wire				X0777240	900-450/577/1-1-1	1.686	NA	Director/D	
B.5504	North	KAPURTHALA	11KV	DS DIVN. KARTARPUR	DS S/D BHOLOTH	0626FL04	KHASSAN	AMR	OK	31.03.2023	AP 3Phase 3Wire				8223533	900-450/577/1-1-1	1.855	NA	Director/D	
B.5505	North	KAPURTHALA	11KV	DS DIVN. KARTARPUR	DS S/D BHOLOTH	0626FL13	RAUPUTAN	AMR	OK	31.03.2023	AP 3Phase 3Wire				10282723	900-450/577/1-1-1	1.902	NA	Director/D	
B.5506	North	KAPURTHALA	11KV	DS DIVN. KARTARPUR	DS S/D BHOLOTH	0626FL02	BAJAI	AMR	OK	31.03.2023	AP 3Phase 3Wire				8223535	900-450/577/1-1-1	2.181	NA	Director/D	
B.5507	North	KAPURTHALA	11KV	DS DIVN. KARTARPUR	DS S/D BHOLOTH	0626FL07	RANGABN	AMR	OK	31.03.2023	AP 3Phase 3Wire				8223384	900-450/577/1-1-1	2.205	NA	Director/D	
B.5508	North	KAPURTHALA	11KV	DS DIVN. KARTARPUR	DS S/D BHOLOTH	0626FL09	LITAN	AMR	OK	31.03.2023	AP 3Phase 3Wire				9154114	900-450/577/1-1-1	2.303	NA	Director/D	
B.5509	North	KAPURTHALA	11KV	DS DIVN. KARTARPUR	DS S/D BHOLOTH	0626FL01	BHATNURA BHOLOTH	NON AMR	OK	31.03.2023	AP 3Phase 3Wire				2994134	900-450/577/1-1-1	2.362	NA	Director/D	
B.5510	North	KAPURTHALA	11KV	DS DIVN. KARTARPUR	DS S/D BHOLOTH	0626FL03	UPS METLA	NON AMR	OK	31.03.2023	Category 5-UPS				7030224	900-450/577/1-1-1	7.385	NA	Director/D	
B.5511	North	KAPURTHALA	11KV	DS DIVN. KARTARPUR	DS S/D BHOLOTH	0626FL05	CAT-1 BHOLOTH	NON AMR	OK	31.03.2023	Category 1				11117301	900-450/577/1-1-1	7.717	NA	Director/D	
B.5512	North	KAPURTHALA	11KV	DS DIVN. KARTARPUR	DS S/D BHOLOTH	0626FL10	UPS PANDORI	NON AMR	OK	31.03.2023	Category 5-UPS				11117378	900-450/577/1-1-1	8.033	NA	Director/D	
B.5513	North	KAPURTHALA	11KV	DS DIVN. KARTARPUR	DS S/D BHOLOTH	0626FL04	CAT-1 BHATNURA	AMR	OK	31.03.2023	Category 1				8223063	900-450/577/1-1-1	9.975	NA	Director/D	
B.5514	North	KAPURTHALA	11KV	DS DIVN. KARTARPUR	DS S/D BHOLOTH	0626FL15	BOPARAI AP	AMR	OK	31.03.2023	AP 3Phase 3Wire				900-450/577/1-1-1	2.048	NA	Director/D		
B.5515	North	KAPURTHALA	11KV	DS DIVN. KARTARPUR	DS S/D BHOLOTH	0626FL02	BHATNURA BAJAI	AMR	OK	31.03.2023	AP 3Phase 3Wire				8223208	900-450/577/1-1-1	2.102	NA	Director/D	
B.5516	North	KAPURTHALA	11KV	DS DIVN. KARTARPUR	DS S/D BHOLOTH	0626FL01	JAID	NON AMR	OK	31.03.2023	AP 3Phase 3Wire				8223206	900-450/577/1-1-1	2.195	NA	Director/D	
B.5517	North	KAPURTHALA	11KV	DS DIVN. KARTARPUR	DS S/D BHOLOTH	0626FL03	UPS BAJAI	NON AMR	OK	31.03.2023	Category 5-UPS				4221077	900-450/577/1-1-1	7.151	NA	Director/D	
B.5518	North	KAPURTHALA	11KV	DS DIVN. KARTARPUR	DS S/D CITY-1 KARTARPUR	8603FL15	Nangal Manohar	AMR	OK	31.03.2023	Category 1				669553	1200/577/1-1-1	1.406	NA	Director/D	
B.5519	North	KAPURTHALA	11KV	DS DIVN. KARTARPUR	DS S/D CITY-1 KARTARPUR	C602FL14	Pali	AMR	OK	31.03.2023	AP 3Phase 3Wire				9140838	1200/577/1-1-1	2.457	NA	Director/D	
B.5520	North	KAPURTHALA	11KV	DS DIVN. KARTARPUR	DS S/D CITY-1 KARTARPUR	C602FL04	Khusropur	NON AMR	OK	31.03.2023	AP 3Phase 3Wire				8222978	1200/577/1-1-1	4.430	NA	Director/D	
B.5521	North	KAPURTHALA	11KV	DS DIVN. KARTARPUR	DS S/D CITY-1 KARTARPUR	8603FL21	Jang-E-azadi Kartarpur	NON AMR	OK	31.03.2023	Category 1				116747	1200/577/1-1-1	5.533	NA	Director/D	
B.5522	North	KAPURTHALA	11KV	DS DIVN. KARTARPUR	DS S/D CITY-1 KARTARPUR	8603FL14	Arva Nagar	NON AMR	OK	31.03.2023	Category 1				11051967	1200/577/1-1-1	8.250	NA	Director/D	
B.5523	North	KAPURTHALA	11KV	DS DIVN. KARTARPUR	DS S/D CITY-1 KARTARPUR	C602FL13	Fateh Jala	NON AMR	OK	31.03.2023	Category 5-UPS				6489885	1200/577/1-1-1	9.403	NA	Director/D	
B.5524	North	KAPURTHALA	11KV	DS DIVN. KARTARPUR	DS S/D CITY-1 KARTARPUR	C602FL09	Cit Kartarpur	NON AMR	OK	31.03.2023	Category 1				6761090	1200/577/1-1-1	10.144	NA	Director/D	
B.5525	North	KAPURTHALA	11KV	DS DIVN. KARTARPUR	DS S/D CITY-1 KARTARPUR	C602FL10	Furniture Bajar	AMR	OK	31.03.2023	Category 1				6486580	1200/577/1-1-1	12.121	NA	Director/D	
B.5526	North	KAPURTHALA	11KV	DS DIVN. KARTARPUR	DS S/D CITY-1 KARTARPUR	0626FL16	Naharpur	AMR	OK	31.03.2023	AP 3Phase 3Wire				9544724	900-450/577/1-1-1	0.866	NA	Director/D	
B.5527	North	KAPURTHALA	11KV	DS DIVN. KARTARPUR	DS S/D CITY-1 KARTARPUR	0626FL02	Brahmpur	AMR	OK	31.03.2023	AP 3Phase 3Wire				11116954	900-450/577/1-1-1	1.447	NA	Director/D	
B.5528	North	KAPURTHALA	11KV	DS DIVN. KARTARPUR	DS S/D CITY-1 KARTARPUR	E604FL07	Fasalpur	AMR	OK	31.03.2023	AP 3Phase 3Wire				11116954	900-450/577/1-1-1	1.567	NA	Director/D	
B.5529	North	KAPURTHALA	11KV	DS DIVN. KARTARPUR	DS S/D CITY-1 KARTARPUR	E604FL08	Kot Kraz Khan	AMR	OK	31.03.2023	AP 3Phase 3Wire				15198623	900-450/577/1-1-1	2.180	NA	Director/D	
B.5530	North	KAPURTHALA	11KV	DS DIVN. KARTARPUR	DS S/D CITY-1 KARTARPUR	E604FL09	Bhoshampur	AMR	OK	31.03.2023	AP 3Phase 3Wire				2066944	900-450/577/1-1-1	2.272	NA	Director/D	
B.5531	North	KAPURTHALA	11KV	DS DIVN. KARTARPUR	DS S/D CITY-1 KARTARPUR	E604FL13	G. J. Agro	NON AMR	OK	31.03.2023	Category 1				9544724	900-450/577/1-1-1	5.583	NA	Director/D	
B.5532	North	KAPURTHALA	11KV	DS DIVN. KARTARPUR	DS S/D CITY-1 KARTARPUR	E604FL12	Pattar Kalan	NON AMR	OK	31.03.2023	Category 5-UPS				11116794	900-450/577/1-1-1	8.010	NA	Director/D	
B.5533	North	KAPURTHALA	11KV	DS DIVN. KARTARPUR	DS S/D CITY-1 KARTARPUR	8603FL00	FATEH JALAL	NON AMR	OK	31.03.2023	Category 5-UPS				6489885	1200/577/1-1-1	0.000	NA	Director/D	
B.5534	North	KAPURTHALA	11KV	DS DIVN. KARTARPUR	DS S/D CITY-2 KARTARPUR	8603FL16	UPS Ambgarh	AMR	OK	31.03.2023	Category 5-UPS				9154166	1200/577/1-1-1	0.732	NA	Director/D	
B.5535	North	KAPURTHALA	11KV	DS DIVN. KARTARPUR	DS S/D CITY-2 KARTARPUR	8603FL07	Budhpur	AMR	OK	31.03.2023	AP 3Phase 3Wire				8222978	1200/577/1-1-1	1.576	NA	Director/D	
B.5536	North	KAPURTHALA	11KV	DS DIVN. KARTARPUR	DS S/D CITY-2 KARTARPUR	8603FL02	Mustafapur	AMR	OK	31.03.2023	AP 3Phase 3Wire				9140838	1200/577/1-1-1	2.040	NA	Director/D	
B.5537	North	KAPURTHALA	11KV	DS DIVN. KARTARPUR	DS S/D CITY-2 KARTARPUR	8603FL02	Lidhran	NON AMR	OK	31.03.2023	AP 3Phase 3Wire				8222977	1200/577/1-1-1	2.040	NA	Director/D	
B.5538	North	KAPURTHALA	11KV	DS DIVN. KARTARPUR	DS S/D CITY-2 KARTARPUR	8603FL19	Jalla Singh	AMR	OK	31.03.2023	AP 3Phase 3Wire				116747	1200/577/1-1-1	2.174	NA	Director/D	
B.5539	North	KAPURTHALA	11KV	DS DIVN. KARTARPUR	DS S/D CITY-2 KARTARPUR	8603FL01	Srai Khaz	AMR	OK	31.03.2023	AP 3Phase 3Wire				9140835	1200/577/1-1-1	2.252	NA	Director/D	
B.5540	North	KAPURTHALA	11KV	DS DIVN. KARTARPUR	DS S/D CITY-2 KARTARPUR	8603FL17	Nandampur	AMR	OK	31.03.2023	AP 3Phase 3Wire				1077894	1200/577/1-1-1	2.461	NA	Director/D	
B.5541	North	KAPURTHALA	11KV	DS DIVN. KARTARPUR	DS S/D CITY-2 KARTARPUR	8603FL18	Bhujalpur	AMR	OK	31.03.2023	AP 3Phase 3Wire				9140838	1200/577/1-1-1	2.478	NA	Director/D	
B.5542	North	KAPURTHALA	11KV	DS DIVN. KARTARPUR	DS S/D CITY-2 KARTARPUR	8603FL03	Kartarpur	NON AMR	OK	31.03.2023	AP 3Phase 3Wire				8222980	1200/577/1-1-1	2.880	NA	Director/D	
B.5543	North	KAPURTHALA	11KV	DS DIVN. KARTARPUR	DS S/D CITY-2 KARTARPUR	8603FL09	R. E. C	NON AMR	OK	31.03.2023	Category 2				6489721	1200/577/1-1-1	4.639	NA	Director/D	
B.5544	North	KAPURTHALA	11KV	DS DIVN. KARTARPUR	DS S/D CITY-2 KARTARPUR	8603FL15	URBAN Bye Pass	NON AMR	OK	31.03.2023	Category 1				6740916	1200/577/1-1-1	8.224	NA	Director/D	
B.5545	North	KAPURTHALA	11KV	DS DIVN. KARTARPUR	DS S/D CITY-2 KARTARPUR	8603FL11	UPS Kahlwan	AMR	OK	31.03.2023	Category 5-UPS				6740919	1200/577/1-1-1	10.220	NA	Director/D	
B.5546	North	KAPURTHALA	11KV	DS DIVN. KARTARPUR	DS S/D CITY-2 KARTARPUR	0626FL08	URBAN Suraj Nussli	NON AMR	OK	31.03.2023	Category 1				8222780	1200/577/1-1-1	13.767	NA	Director/D	
B.5547	North	KAPURTHALA	11KV	DS DIVN. KARTARPUR	DS S/D CITY-2 KARTARPUR	0626FL13	SATN TF Mustafapur	AMR	OK	31.03.2023	Substation Transformer				10281236	600/577/1-1-1	0.000	NA	Director/D	
B.5548	North	KAPURTHALA	11KV	DS DIVN. KARTARPUR	DS S/D CITY-2 KARTARPUR	0626FL08	Naugajia	AMR	OK	31.03.2023	AP 3Phase 3Wire				8222425	600/577/1-1-1	1.824	NA	Director/D	
B.5549	North	KAPURTHALA	11KV	DS DIVN. KARTARPUR	DS S/D CITY-2 KARTARPUR	0626FL12	BARA PIND	AMR	OK	31.03.2023	AP 3Phase 3Wire				1	600/577/1-1-1	1.868	NA	Director/D	
B.5550	North	KAPURTHALA	11KV	DS DIVN. KARTARPUR	DS S/D CITY-2 KARTARPUR	0626FL11	Shivdaspur	AMR	OK	31.03.2023	AP 3Phase 3Wire				10281236	600/577/1-1-1	2.113	NA	Director/D	
B.5551	North	KAPURTHALA	11KV	DS DIVN. KARTARPUR	DS S/D CITY-2 KARTARPUR	0626FL02	Duggi	AMR	OK	31.03.2023	AP 3Phase 3Wire				8223319	600/577/1-1-1	2.216	NA	Director/D	
B.5552	North	KAPURTHALA	11KV	DS DIVN. KARTARPUR	DS S/D CITY-2 KARTARPUR	0626FL06	Maje ki	AMR	OK	31.03.2023	AP 3Phase 3Wire				8223069	600/577/1-1-1	2.285	NA	Director/D	
B.5553	North	KAPURTHALA	11KV	DS DIVN. KARTARPUR	DS S/D CITY-2 KARTARPUR	0626FL03	Rajab	AMR	OK	31.03.2023	AP 3Phase 3Wire				8222804	600/577/1-1-1	2.636	NA	Director/D	
B.5554	North	KAPURTHALA	11KV	DS DIVN. KARTARPUR	DS S/D CITY-2 KARTARPUR	0626FL07	UPS Rahimpur	AMR	OK	31.03.2023	Category 5-UPS				2068578	600/577/1-1-1	4.140	NA	Director/D	
B.5555	North																			

S.No	Zone	Circle	Voltage Level (kVA)	Division (kVA)	Sub-Division (kVA)	Feeder ID	Feeder Name	Feeder Metering Status (Metered/unmetered/AMR/AMI)	Status of Meter (Functional/Non-Functional)	Metering Date (Date of last actual meter reading/communication)	Feeder Type (Agr/Industrial/Mixed)	Status of Communication			Period from 01.04.2021 to 31.03.2022			Sales	Remarks (Source of data)
												% data received through automatically if feeder AMR/AMI	Number of hours when meter was unable to communicate in overall	Total Number of hours in the period	Meter S.No	CT/PT ratio	Import (kWh)		
B.5596	North	KAPURTHALA	11KV	DS S/U DIVN. KAPURTHA DS S/D DHILWAN		C604FL01	BHULLAR	NON AMR	OK	31.03.2023	AP 3Phase 3Wire				8223823	1200-600/5	1.087	NA	Director/D
B.5597	North	KAPURTHALA	11KV	DS S/U DIVN. KAPURTHA DS S/D DHILWAN		C604FL11	JANUHA	AMR	OK	31.03.2023	AP 3Phase 3Wire				66234	900-450/577/1-1	1.775	NA	Director/D
B.5598	North	KAPURTHALA	11KV	DS S/U DIVN. KAPURTHA DS S/D DHILWAN		C604FL28	NURPUR	AMR	OK	31.03.2023	AP 3Phase 3Wire				6669381	1200-600/5	2.157	NA	Director/D
B.5599	North	KAPURTHALA	11KV	DS S/U DIVN. KAPURTHA DS S/D DHILWAN		C604FL02	HABIB PUR	AMR	OK	31.03.2023	AP 3Phase 3Wire				8223824	1200-600/5	2.218	NA	Director/D
B.5600	North	KAPURTHALA	11KV	DS S/U DIVN. KAPURTHA DS S/D DHILWAN		C604FL03	BUTALA	AMR	OK	31.03.2023	AP 3Phase 3Wire				8223825	1200-600/5	2.306	NA	Director/D
B.5601	North	KAPURTHALA	11KV	DS S/U DIVN. KAPURTHA DS S/D DHILWAN		C604FL07	RAMIDI	AMR	OK	31.03.2023	AP 3Phase 3Wire				8223822	1200-600/5	2.547	NA	Director/D
B.5602	North	KAPURTHALA	11KV	DS S/U DIVN. KAPURTHA DS S/D DHILWAN		C604FL04	DHARWAL	NON AMR	OK	31.03.2023	AP 3Phase 3Wire				8333821	1200-600/5	2.716	NA	Director/D
B.5603	North	KAPURTHALA	11KV	DS S/U DIVN. KAPURTHA DS S/D DHILWAN		C604FL10	UPS BHANDAL	NON AMR	OK	31.03.2023	Category 5-UPS				2065900	900-450/577/1-1	7.823	NA	Director/D
B.5604	North	KAPURTHALA	11KV	DS S/U DIVN. KAPURTHA DS S/D DHILWAN		C604FL06	URBAN DHILWAN	NON AMR	OK	31.03.2023	Category 1				2068861	1200-600/5	10.315	NA	Director/D
B.5605	North	KAPURTHALA	11KV	DS S/U DIVN. KAPURTHA DS S/D DHILWAN		C604FL09	UPS HOTHIAN	AMR	OK	31.03.2023	Category 5-UPS				2068814	900-450/577/1-1	10.428	NA	Director/D
B.5606	North	KAPURTHALA	11KV	DS S/U DIVN. KAPURTHA DS S/D DHILWAN		E618FL07	Jhal thirkwal	AMR	OK	31.03.2023	AP 3Phase 3Wire				V0197953	900-450/577/1-1	1.133	NA	Director/D
B.5607	North	KAPURTHALA	11KV	DS S/U DIVN. KAPURTHA DS S/D DHILWAN		E618FL02	BUODUWAL	AMR	OK	31.03.2023	AP 3Phase 3Wire				33463	900-450/577/1-1	1.712	NA	Director/D
B.5608	North	KAPURTHALA	11KV	DS S/U DIVN. KAPURTHA DS S/D DHILWAN		D631FL03	JATIKE	AMR	OK	31.03.2023	AP 3Phase 3Wire				8222619	900-450/577/1-1	1.716	NA	Director/D
B.5609	North	KAPURTHALA	11KV	DS S/U DIVN. KAPURTHA DS S/D DHILWAN		D631FL05	PADEVE	AMR	OK	31.03.2023	AP 3Phase 3Wire				8222391	900-450/577/1-1	2.727	NA	Director/D
B.5610	North	KAPURTHALA	11KV	DS S/U DIVN. KAPURTHA DS S/D DHILWAN		D631FL08	Biji Nangal	NON AMR	OK	31.03.2023	Category 5-UPS				1636	900-450/577/1-1	4.312	NA	Director/D
B.5611	North	KAPURTHALA	11KV	DS S/U DIVN. KAPURTHA DS S/D DHILWAN		E618FL01	UPS KHUKHRAN	AMR	OK	31.03.2023	Category 5-UPS				910228	900-450/577/1-1	8.193	NA	Director/D
B.5612	North	KAPURTHALA	11KV	DS S/U DIVN. KAPURTHA DS S/D DHILWAN		D630FL02	himant Nagar	NON AMR	OK	31.03.2023	AP 3Phase 3Wire				8222617	900-450/577/1-1	1.823	NA	Director/D
B.5613	North	KAPURTHALA	11KV	DS S/U DIVN. KAPURTHA DS S/D NADALA		E618FL10	Sub Station	AMR	OK	31.03.2023	Substation Transformer				6702582	1200-600/5	0.000	NA	Director/D
B.5614	North	KAPURTHALA	11KV	DS S/U DIVN. KAPURTHA DS S/D NADALA		E618FL12	Khalve	AMR	OK	31.03.2023	AP 3Phase 3Wire				1	900-450/577/1-1	1.415	NA	Director/D
B.5615	North	KAPURTHALA	11KV	DS S/U DIVN. KAPURTHA DS S/D NADALA		E618FL05	HASSUWAL	AMR	OK	31.03.2023	AP 3Phase 3Wire				11117282	900-450/577/1-1	1.623	NA	Director/D
B.5616	North	KAPURTHALA	11KV	DS S/U DIVN. KAPURTHA DS S/D NADALA		E618FL06	TALWANDI	AMR	OK	31.03.2023	AP 3Phase 3Wire				9154378	1200-600/5	1.716	NA	Director/D
B.5617	North	KAPURTHALA	11KV	DS S/U DIVN. KAPURTHA DS S/D NADALA		E618FL03	BHAKUWAL	NON AMR	OK	31.03.2023	AP 3Phase 3Wire				X077630	1200-600/5	1.805	NA	Director/D
B.5618	North	KAPURTHALA	11KV	DS S/U DIVN. KAPURTHA DS S/D NADALA		E618FL-1	daudpur	AMR	OK	31.03.2023	AP 3Phase 3Wire				5388158	1200-600/5	1.891	NA	Director/D
B.5619	North	KAPURTHALA	11KV	DS S/U DIVN. KAPURTHA DS S/D NADALA		E618FL07	PASSIWAAL	NON AMR	OK	31.03.2023	AP 3Phase 3Wire				9154474	900-450/577/1-1	2.025	NA	Director/D
B.5620	North	KAPURTHALA	11KV	DS S/U DIVN. KAPURTHA DS S/D NADALA		E618FL02	JUG	AMR	OK	31.03.2023	AP 3Phase 3Wire				11117290	1200-600/5	2.100	NA	Director/D
B.5621	North	KAPURTHALA	11KV	DS S/U DIVN. KAPURTHA DS S/D NADALA		E618FL01	DALLA	AMR	OK	31.03.2023	AP 3Phase 3Wire				X077812	1200-600/5	2.137	NA	Director/D
B.5622	North	KAPURTHALA	11KV	DS S/U DIVN. KAPURTHA DS S/D NADALA		E618FL11	MAND UPS	NON AMR	OK	31.03.2023	Category 5-UPS				1	900-450/577/1-1	5.778	NA	Director/D
B.5623	North	KAPURTHALA	11KV	DS S/U DIVN. KAPURTHA DS S/D NADALA		E618FL09	UPS MODEL TOWN	AMR	OK	31.03.2023	Category 5-UPS				7336846	1200-600/5	9.011	NA	Director/D
B.5624	North	KAPURTHALA	11KV	DS S/U DIVN. KAPURTHA DS S/D NADALA		E618FL06	UPS IBBRAHIMWAL	NON AMR	OK	31.03.2023	Category 5-UPS				5388158	900-450/577/1-1	10.468	NA	Director/D
B.5625	North	KAPURTHALA	11KV	DS S/U DIVN. KAPURTHA DS S/D NADALA		E618FL04	URBAN NADALA	AMR	OK	31.03.2023	Category 1				11117119	1200-600/5	10.489	NA	Director/D
B.5626	North	KAPURTHALA	11KV	DS S/U DIVN. KAPURTHA DS S/D TIBBA		D631FL03	BISHPUR	AMR	OK	31.03.2023	AP 3Phase 3Wire				52194882	1200-800/5	1.256	NA	Director/D
B.5627	North	KAPURTHALA	11KV	DS S/U DIVN. KAPURTHA DS S/D TIBBA		D631FL02	RHIZARPUR	AMR	OK	31.03.2023	AP 3Phase 3Wire				2066023	900-450/577/1-1	1.902	NA	Director/D
B.5628	North	KAPURTHALA	11KV	DS S/U DIVN. KAPURTHA DS S/D TIBBA		D631FL06	SHIVDAL	AMR	OK	31.03.2023	AP 3Phase 3Wire				2067478	1200-600/5	2.042	NA	Director/D
B.5629	North	KAPURTHALA	11KV	DS S/U DIVN. KAPURTHA DS S/D TIBBA		D631FL07	Tur	NON AMR	OK	31.03.2023	AP 3Phase 3Wire				1	1200-600/5	2.129	NA	Director/D
B.5630	North	KAPURTHALA	11KV	DS S/U DIVN. KAPURTHA DS S/D TIBBA		D631FL04	URBAN TALWANDI	AMR	OK	31.03.2023	Category 1				1	1200-600/5	9.941	NA	Director/D
B.5631	North	KAPURTHALA	11KV	DS S/U DIVN. KAPURTHA DS S/D TIBBA		D638FL11	AMARKOT	AMR	OK	31.03.2023	AP 3Phase 3Wire				36814	Not installed	1.054	NA	Director/D
B.5632	North	KAPURTHALA	11KV	DS S/U DIVN. KAPURTHA DS S/D TIBBA		D638FL06	KALU	AMR	OK	31.03.2023	AP 3Phase 3Wire				8222368	Not installed	1.545	NA	Director/D
B.5633	North	KAPURTHALA	11KV	DS S/U DIVN. KAPURTHA DS S/D TIBBA		D638FL02	ROCKPUR	AMR	OK	31.03.2023	AP 3Phase 3Wire				8222707	Not installed	1.629	NA	Director/D
B.5634	North	KAPURTHALA	11KV	DS S/U DIVN. KAPURTHA DS S/D TIBBA		D638FL09	DAMDAMA SAHIB	AMR	OK	31.03.2023	AP 3Phase 3Wire				34058	Not installed	1.645	NA	Director/D
B.5635	North	KAPURTHALA	11KV	DS S/U DIVN. KAPURTHA DS S/D TIBBA		D638FL05	SAIDPUR	AMR	OK	31.03.2023	AP 3Phase 3Wire				8222366	Not installed	1.716	NA	Director/D
B.5636	North	KAPURTHALA	11KV	DS S/U DIVN. KAPURTHA DS S/D TIBBA		D638FL08	KAINA	AMR	OK	31.03.2023	AP 3Phase 3Wire				8222710	Not installed	1.853	NA	Director/D
B.5637	North	KAPURTHALA	11KV	DS S/U DIVN. KAPURTHA DS S/D TIBBA		D638FL04	MUND	NON AMR	OK	31.03.2023	AP 3Phase 3Wire				8222326	Not installed	1.906	NA	Director/D
B.5638	North	KAPURTHALA	11KV	DS S/U DIVN. KAPURTHA DS S/D TIBBA		D638FL01	MANGALPUR	NON AMR	OK	31.03.2023	AP 3Phase 3Wire				8222709	Not installed	2.102	NA	Director/D
B.5639	North	KAPURTHALA	11KV	DS S/U DIVN. KAPURTHA DS S/D TIBBA		E608FL03	URBAN TIBBA	NON AMR	OK	31.03.2023	Category 1				2068610	Not installed	5.951	NA	Director/D
B.5640	North	KAPURTHALA	11KV	DS S/U DIVN. KAPURTHA DS S/D TIBBA		E608FL10	UPS SUIOKALIA	NON AMR	OK	31.03.2023	Category 5-UPS				7035649	Not installed	7.256	NA	Director/D
B.5641	North	KAPURTHALA	11KV	DS S/U DIVN. KAPURTHA DS S/D TIBBA		E608FL07	UPS MITRA	AMR	OK	31.03.2023	Category 5-UPS				8223674	Not installed	8.328	NA	Director/D
B.5642	North	KAPURTHALA	11KV	DS S/U DIVN. KAPURTHA DS S/D UCHHA		D638FL01	Purana Kollianwal	NON AMR	OK	31.03.2023	AP 3Phase 3Wire				24354	900-450/5	0.456	NA	Director/D
B.5643	North	KAPURTHALA	11KV	DS S/U DIVN. KAPURTHA DS S/D UCHHA		E608FL02	DABILUAN	NON AMR	OK	31.03.2023	Category 5-UPS				8223368	900-450/5	1.023	NA	Director/D
B.5644	North	KAPURTHALA	11KV	DS S/U DIVN. KAPURTHA DS S/D UCHHA		E608FL05	DARIEWAL	AMR	OK	31.03.2023	AP 3Phase 3Wire				7336884	900-450/5	1.345	NA	Director/D
B.5645	North	KAPURTHALA	11KV	DS S/U DIVN. KAPURTHA DS S/D UCHHA		E608FL03	KHERA	AMR	OK	31.03.2023	AP 3Phase 3Wire				8222618	900-450/577/1-1	1.876	NA	Director/D
B.5646	North	KAPURTHALA	11KV	DS S/U DIVN. KAPURTHA DS S/D UCHHA		D630FL01	KISHAN SINGH WALA	AMR	OK	31.03.2023	AP 3Phase 3Wire				8222616	900-450/577/1-1	2.022	NA	Director/D
B.5647	North	KAPURTHALA	11KV	DS S/U DIVN. KAPURTHA DS S/D UCHHA		E608FL07	Baghuana	AMR	OK	31.03.2023	AP 3Phase 3Wire				1	900-450/577/1-1	2.562	NA	Director/D
B.5648	North	KAPURTHALA	11KV	DS S/U DIVN. KAPURTHA DS S/D UCHHA		E608FL04	UPS SURHPUR	AMR	OK	31.03.2023	Category 5-UPS				1959877	900-450/577/1-1	5.741	NA	Director/D
B.5649	North	KAPURTHALA	11KV	DS S/U DIVN. KAPURTHA DS S/D UCHHA		D638FL10	SHAHNOUR	AMR	OK	31.03.2023	AP 3Phase 3Wire				8222433	900-450/577/1-1	1.302	NA	Director/D
B.5650	North	KAPURTHALA	11KV	DS S/U DIVN. KAPURTHA DS S/D UCHHA		D638FL09	SIKHDOLA	AMR	OK	31.03.2023	AP 3Phase 3Wire				1	900-450/577/1-1	1.090	NA	Director/D
B.5651	North	KAPURTHALA	11KV	DS S/U DIVN. KAPURTHA DS S/D UCHHA		E608FL06	MEHMEDWAL	AMR	OK	31.03.2023	AP 3Phase 3Wire				8223410	900-450/577/1-1	1.525	NA	Director/D
B.5652	North	KAPURTHALA	11KV	DS S/U DIVN. KAPURTHA DS S/D UCHHA		E608FL08	GOPH PUR	AMR	OK	31.03.2023	AP 3Phase 3Wire				8223091	900-450/577/1-1	1.593	NA	Director/D
B.5653	North	KAPURTHALA	11KV	DS S/U DIVN. KAPURTHA DS S/D UCHHA		E608FL01	UCHA	AMR	OK	31.03.2023	AP 3Phase 3Wire				9141111	900-450/577/1-1	1.632	NA	Director/D
B.5654	North	KAPURTHALA	11KV	DS S/U DIVN. KAPURTHA DS S/D UCHHA		D638FL02	RATLA	AMR	OK	31.03.2023	AP 3Phase 3Wire				8223355	900-450/577/1-1	1.806	NA	Director/D
B.5655	North	KAPURTHALA	11KV	DS S/U DIVN. KAPURTHA DS S/D UCHHA		E608FL09	RAJEWAL	AMR	OK	31.03.2023	AP 3Phase 3Wire				8222433	900-450/577/1-1	1.817	NA	Director/D
B.5656	North	KAPURTHALA	11KV	DS S/U DIVN. KAPURTHA DS S/D UCHHA		E608FL03	KHIRANWALI	NON AMR	OK	31.03.2023	AP 3Phase 3Wire				8222424	900-450/577/1-1	1.912	NA	Director/D
B.5657	North	KAPURTHALA	11KV	DS S/U DIVN. KAPURTHA DS S/D UCHHA		E608FL04	URBAN FATTUHINGA	NON AMR	OK	31.03.2023	Category 1				2068801	900-450/577/1-1	4.383	NA	Director/D
B.5658	North	KAPURTHALA	11KV	DS S/U DIVN. KAPURTHA DS S/D UCHHA		E608FL10	UPS NANAKPUR	NON AMR	OK	31.03.2023	Category 5-UPS				2068885	900-450/577/1-1	10.682	NA	Director/D
B.5659	North	KAPURTHALA	11KV	DS S/U DIVN. KAPURTHA DS S/D UCHHA		E608FL07	UPS GURSAR	AMR	OK	31.03.2023	Category 5-UPS				2068308	900-450/577/1-1	12.530	NA	Director/D
B.5660	North	KAPURTHALA	11KV	DS S/U DIVN. KAPURTHA DS S/S/D KAPURTHALA		C601FL15	URBAN FED	AMR	OK	31.03.2023	Category 2								

S.No	Zone	Circle	Voltage Level (kVA)	Division (kVA)	Sub-Division (kVA)	Feeder ID	Feeder Name	Feeder Metering Status (Metered/unmetered/AM/AMR)	Status of Meter (Functional/Non-Functional)	Metering Date	Date of last actual meter reading/communication	Feeder Type (Agr./Industrial/Mixed)	Status of Communication			Period from 01.04.2021 to 31.03.2022				Sales	Remarks (Source of data)
													% data received through automatically if feeder AMR/AM	Number of hours when meter was unable to communicate in overall	Total Number of hours in the period	Meter S.No	CT/PT ratio	Import (kWh)	Export (kWh)		
B.5693	North	KAPURTHALA	11KV	DS S/U DIVN. NAKODAR	DS S/D BILGA	C060FL14	UPS Saidowal	AMR	OK	31.03.2023		Category 5-UPS				11116880	900-450/577/1-1-1	6.361	NA	Director/D	
B.5694	North	KAPURTHALA	11KV	DS S/U DIVN. NAKODAR	DS S/D BILGA	D039FL14	Kandola	AMR	OK	31.03.2023		AP 3Phase 3Wire				10077784	900-450/577/1-1-1	0.000	NA	Director/D	
B.5695	North	KAPURTHALA	11KV	DS S/U DIVN. NAKODAR	DS S/D BILGA	E013FL18	Chauhanpur	AMR	OK	31.03.2023		AP 3Phase 3Wire				10224918	900-450/577/1-1-1	1.101	NA	Director/D	
B.5696	North	KAPURTHALA	11KV	DS S/U DIVN. NAKODAR	DS S/D BILGA	D039FL08	Shekhpur	NON AMR	OK	31.03.2023		AP 3Phase 3Wire				12479418	900-450/577/1-1-1	1.321	NA	Director/D	
B.5697	North	KAPURTHALA	11KV	DS S/U DIVN. NAKODAR	DS S/D BILGA	D039FL13	Lidhar Kalan	AMR	OK	31.03.2023		AP 3Phase 3Wire				9546679	900-450/577/1-1-1	1.412	NA	Director/D	
B.5698	North	KAPURTHALA	11KV	DS S/U DIVN. NAKODAR	DS S/D BILGA	E013FL11	Bhullara	AMR	OK	31.03.2023		AP 3Phase 3Wire				10077783	900-450/577/1-1-1	2.165	NA	Director/D	
B.5699	North	KAPURTHALA	11KV	DS S/U DIVN. NAKODAR	DS S/D BILGA	D039FL04	Puawadara	AMR	OK	31.03.2023		AP 3Phase 3Wire				2066806	900-450/577/1-1-1	2.193	NA	Director/D	
B.5700	North	KAPURTHALA	11KV	DS S/U DIVN. NAKODAR	DS S/D BILGA	D039FL15	Khela	AMR	OK	31.03.2023		AP 3Phase 3Wire				10288402	900-450/577/1-1-1	2.292	NA	Director/D	
B.5701	North	KAPURTHALA	11KV	DS S/U DIVN. NAKODAR	DS S/D BILGA	E013FL03	Maa Sahib	AMR	OK	31.03.2023		AP 3Phase 3Wire				2067010	900-450/577/1-1-1	2.408	NA	Director/D	
B.5702	North	KAPURTHALA	11KV	DS S/U DIVN. NAKODAR	DS S/D BILGA	D039FL02	Thamanwal	NON AMR	OK	31.03.2023		AP 3Phase 3Wire				9154005	900-450/577/1-1-1	2.481	NA	Director/D	
B.5703	North	KAPURTHALA	11KV	DS S/U DIVN. NAKODAR	DS S/D BILGA	E013FL06	Gumta	AMR	OK	31.03.2023		AP 3Phase 3Wire				10282991	900-450/577/1-1-1	2.604	NA	Director/D	
B.5704	North	KAPURTHALA	11KV	DS S/U DIVN. NAKODAR	DS S/D BILGA	D039FL07	Paraburpa	AMR	OK	31.03.2023		AP 3Phase 3Wire				2067271	900-450/577/1-1-1	3.701	NA	Director/D	
B.5705	North	KAPURTHALA	11KV	DS S/U DIVN. NAKODAR	DS S/D BILGA	E013FL10	NAGRA	AMR	OK	31.03.2023		AP 3Phase 3Wire				10077784	900-450/577/1-1-1	4.689	NA	Director/D	
B.5706	North	KAPURTHALA	11KV	DS S/U DIVN. NAKODAR	DS S/D BILGA	E013FL13	Taggar	NON AMR	OK	31.03.2023		AP 3Phase 3Wire				10077885	900-450/577/1-1-1	4.786	NA	Director/D	
B.5707	North	KAPURTHALA	11KV	DS S/U DIVN. NAKODAR	DS S/D BILGA	E013FL09	UPS Sangwal Bet	AMR	OK	31.03.2023		Category 5-UPS				10281323	900-450/577/1-1-1	6.056	NA	Director/D	
B.5708	North	KAPURTHALA	11KV	DS S/U DIVN. NAKODAR	DS S/D BILGA	D039FL12	UPS Aulia	NON AMR	OK	31.03.2023		Category 5-UPS				6489734	900-450/577/1-1-1	6.560	NA	Director/D	
B.5709	North	KAPURTHALA	11KV	DS S/U DIVN. NAKODAR	DS S/D BILGA	E013FL05	UPS Paraburpa	NON AMR	OK	31.03.2023		Category 5-UPS				10282942	900-450/577/1-1-1	9.665	NA	Director/D	
B.5710	North	KAPURTHALA	11KV	DS S/U DIVN. NAKODAR	DS S/D BILGA	E013FL01	URBAN Bilga	AMR	OK	31.03.2023		Category 1				10281316	900-450/577/1-1-1	9.950	NA	Director/D	
B.5711	North	KAPURTHALA	11KV	DS S/U DIVN. NAKODAR	DS S/D BILGA	D069FL13	Shekhu Pur	AMR	OK	31.03.2023		AP 3Phase 3Wire				34107	900-450/577/1-1-1	2.496	NA	Director/D	
B.5712	North	KAPURTHALA	11KV	DS S/U DIVN. NAKODAR	DS S/D BILGA	E013FL09	SANDARA	NON AMR	OK	31.03.2023		AP 3Phase 3Wire				2066213	900-450/577/1-1-1	2.076	NA	Director/D	
B.5713	North	KAPURTHALA	11KV	DS S/U DIVN. NAKODAR	DS S/D CITY NAKODAR	C030FL11	Court Complex	AMR	OK	31.03.2023		Category 1				9140935	1200-600/5	0.182	NA	Director/D	
B.5714	North	KAPURTHALA	11KV	DS S/U DIVN. NAKODAR	DS S/D CITY NAKODAR	C030FL15	Elahawal	AMR	OK	31.03.2023		AP 3Phase 3Wire				8222723	1200-600/5	2.278	NA	Director/D	
B.5715	North	KAPURTHALA	11KV	DS S/U DIVN. NAKODAR	DS S/D CITY NAKODAR	C030FL09	Pandori	AMR	OK	31.03.2023		AP 3Phase 3Wire				9140932	1200-600/5	2.816	NA	Director/D	
B.5716	North	KAPURTHALA	11KV	DS S/U DIVN. NAKODAR	DS S/D CITY NAKODAR	C030FL18	Tai	AMR	OK	31.03.2023		Category 1				1	1200-600/5	5.607	NA	Director/D	
B.5717	North	KAPURTHALA	11KV	DS S/U DIVN. NAKODAR	DS S/D CITY NAKODAR	C030FL17	Nawi Abad	NON AMR	OK	31.03.2023		Category 1				1	1200-600/5	8.068	NA	Director/D	
B.5718	North	KAPURTHALA	11KV	DS S/U DIVN. NAKODAR	DS S/D CITY NAKODAR	C030FL13	URBAN Dana mandi	NON AMR	OK	31.03.2023		Category 1				8223791	1200-600/5	8.595	NA	Director/D	
B.5719	North	KAPURTHALA	11KV	DS S/U DIVN. NAKODAR	DS S/D CITY NAKODAR	C030FL10	URBAN Civil Hospital	NON AMR	OK	31.03.2023		Category 1				9140871	1200-600/5	10.726	NA	Director/D	
B.5720	North	KAPURTHALA	11KV	DS S/U DIVN. NAKODAR	DS S/D CITY NAKODAR	C030FL05	URBAN Khadar Bhandar	NON AMR	OK	31.03.2023		Category 1				8223794	1200-600/5	11.727	NA	Director/D	
B.5721	North	KAPURTHALA	11KV	DS S/U DIVN. NAKODAR	DS S/D CITY NAKODAR	C030FL14	URBAN Dhakni Gate	AMR	OK	31.03.2023		Category 1				6749925	1200-600/5	12.018	NA	Director/D	
B.5722	North	KAPURTHALA	11KV	DS S/U DIVN. NAKODAR	DS S/D CITY NAKODAR	D069FL09	11KV Billi Chaharni UPS	AMR	OK	31.03.2023		Category 5-UPS				10282874	900-450/577/1-1-1	2.637	NA	Director/D	
B.5723	North	KAPURTHALA	11KV	DS S/U DIVN. NAKODAR	DS S/D CITY NAKODAR	D069FL04	Khuripur	AMR	OK	31.03.2023		AP 3Phase 3Wire				9140917	900-450/577/1-1-1	2.683	NA	Director/D	
B.5724	North	KAPURTHALA	11KV	DS S/U DIVN. NAKODAR	DS S/D CITY NAKODAR	D069FL05	Nawa sind jattan	AMR	OK	31.03.2023		AP 3Phase 3Wire				2067281	900-450/577/1-1-1	4.202	NA	Director/D	
B.5725	North	KAPURTHALA	11KV	DS S/U DIVN. NAKODAR	DS S/D MALLIAN	D069FL05	Nikhi Talwandi	AMR	OK	31.03.2023		AP 3Phase 3Wire				9141211	900-450/577/1-1-1	2.047	NA	Director/D	
B.5726	North	KAPURTHALA	11KV	DS S/U DIVN. NAKODAR	DS S/D MALLIAN	D069FL25	UPS HERAN	AMR	OK	31.03.2023		Category 5-UPS				7336866	900-450/577/1-1-1	2.117	NA	Director/D	
B.5727	North	KAPURTHALA	11KV	DS S/U DIVN. NAKODAR	DS S/D MALLIAN	B060FL07	Heran	AMR	OK	31.03.2023		AP 3Phase 3Wire				9140614	900-450/577/1-1-1	2.992	NA	Director/D	
B.5728	North	KAPURTHALA	11KV	DS S/U DIVN. NAKODAR	DS S/D MALLIAN	D067FL18	BALNAU	NON AMR	OK	31.03.2023		AP 3Phase 3Wire				1	900-450/577/1-1-1	2.299	NA	Director/D	
B.5729	North	KAPURTHALA	11KV	DS S/U DIVN. NAKODAR	DS S/D MALLIAN	D061FL06	BALNAU	AMR	OK	31.03.2023		AP 3Phase 3Wire				11069296	900-450/577/1-1-1	2.127	NA	Director/D	
B.5730	North	KAPURTHALA	11KV	DS S/U DIVN. NAKODAR	DS S/D MALLIAN	D013FL16	Fatehpur	AMR	OK	31.03.2023		AP 3Phase 3Wire				2068322	900-450/577/1-1-1	2.598	NA	Director/D	
B.5731	North	KAPURTHALA	11KV	DS S/U DIVN. NAKODAR	DS S/D MALLIAN	D068FL11	Balkona	NON AMR	OK	31.03.2023		AP 3Phase 3Wire				6675535	900-450/577/1-1-1	0.824	NA	Director/D	
B.5732	North	KAPURTHALA	11KV	DS S/U DIVN. NAKODAR	DS S/D MALLIAN	D068FL17	Jahangir	AMR	OK	31.03.2023		AP 3Phase 3Wire				7030140	900-450/577/1-1-1	1.504	NA	Director/D	
B.5733	North	KAPURTHALA	11KV	DS S/U DIVN. NAKODAR	DS S/D MALLIAN	D068FL05	Talwandi Bharo	AMR	OK	31.03.2023		AP 3Phase 3Wire				9141900	1200/577/1-1-1	1.941	NA	Director/D	
B.5734	North	KAPURTHALA	11KV	DS S/U DIVN. NAKODAR	DS S/D MALLIAN	D068FL13	GILL	AMR	OK	31.03.2023		AP 3Phase 3Wire				2069599	1200/577/1-1-1	1.989	NA	Director/D	
B.5735	North	KAPURTHALA	11KV	DS S/U DIVN. NAKODAR	DS S/D MALLIAN	D068FL01	Bhira	AMR	OK	31.03.2023		AP 3Phase 3Wire				10277396	1200/577/1-1-1	2.079	NA	Director/D	
B.5736	North	KAPURTHALA	11KV	DS S/U DIVN. NAKODAR	DS S/D MALLIAN	D068FL04	Mubarakpur	AMR	OK	31.03.2023		AP 3Phase 3Wire				10077845	1200/577/1-1-1	2.092	NA	Director/D	
B.5737	North	KAPURTHALA	11KV	DS S/U DIVN. NAKODAR	DS S/D MALLIAN	D068FL20	VEVI	AMR	OK	31.03.2023		AP 3Phase 3Wire				1	900-450/577/1-1-1	2.230	NA	Director/D	
B.5738	North	KAPURTHALA	11KV	DS S/U DIVN. NAKODAR	DS S/D MALLIAN	D068FL06	Tut Kala	NON AMR	OK	31.03.2023		AP 3Phase 3Wire				10077546	900-450/577/1-1-1	2.904	NA	Director/D	
B.5739	North	KAPURTHALA	11KV	DS S/U DIVN. NAKODAR	DS S/D MALLIAN	D068FL07	UPS KANG SAHIB RAI	NON AMR	OK	31.03.2023		Category 5-UPS				2066801	1200/577/1-1-1	4.616	NA	Director/D	
B.5740	North	KAPURTHALA	11KV	DS S/U DIVN. NAKODAR	DS S/D MALLIAN	D069FL12	URBAN DIALA ROAD	AMR	OK	31.03.2023		Category 5-UPS				7030560	900-450/577/1-1-1	8.016	NA	Director/D	
B.5741	North	KAPURTHALA	11KV	DS S/U DIVN. NAKODAR	DS S/D NURMAHAL	D069FL08	URBAN TALWAN ROAD	AMR	OK	31.03.2023		Category 5-UPS				9140773	900-450/577/1-1-1	6.991	NA	Director/D	
B.5742	North	KAPURTHALA	11KV	DS S/U DIVN. NAKODAR	DS S/D NURMAHAL	C060FL16	Uppal Jagir	AMR	OK	31.03.2023		AP 3Phase 3Wire				11114593	900-450/577/1-1-1	1.282	NA	Director/D	
B.5743	North	KAPURTHALA	11KV	DS S/U DIVN. NAKODAR	DS S/D NURMAHAL	B060FL18	Urban Divya Jyoti Jagati	AMR	OK	31.03.2023		Category 1				0	900-450/577/1-1-1	1.592	NA	Director/D	
B.5744	North	KAPURTHALA	11KV	DS S/U DIVN. NAKODAR	DS S/D NURMAHAL	C060FL13	Harid Seikh	AMR	OK	31.03.2023		AP 3Phase 3Wire				11116739	900-450/577/1-1-1	2.538	NA	Director/D	
B.5745	North	KAPURTHALA	11KV	DS S/U DIVN. NAKODAR	DS S/D NURMAHAL	C060FL06	Samsabad	AMR	OK	31.03.2023		AP 3Phase 3Wire				11116782	900-450/577/1-1-1	2.641	NA	Director/D	
B.5746	North	KAPURTHALA	11KV	DS S/U DIVN. NAKODAR	DS S/D NURMAHAL	C060FL03	Rampur	AMR	OK	31.03.2023		AP 3Phase 3Wire				11116973	900-450/577/1-1-1	3.016	NA	Director/D	
B.5747	North	KAPURTHALA	11KV	DS S/U DIVN. NAKODAR	DS S/D NURMAHAL	C060FL02	Rampur	AMR	OK	31.03.2023		AP 3Phase 3Wire				FDW00016	900-450/577/1-1-1	3.079	NA	Director/D	

S.No	Zone	Circle	Voltage (kVA)	Division (kVA)	Sub-Division (kVA)	Feeder ID	Feeder Name	Feeder Metering Status (Metered/unmetered/AM/AMR)	Status of Meter (Functional/Non-functional)	Metering Date (Date of last actual meter reading/communication)	Feeder Type (Agr/Industrial/Mixed)	Status of Communication			Period from 01.04.2021 to 31.03.2022			Sales	Remarks (Source of data)
												% Data received through automatically if feeder AMR/AMI	Number of hours when meter was unable to communicate in overall	Total Number of hours in the period	Meter S.No	CT/PT ratio	Import (kU)		
B.5790	North	KAPURTHALA	11KV	DS S/U DIVN. NAKODAR	DS S/D SHANKAR	D066FL17	DHERRIAN	AMR	OK	31.03.2023	AP 3Phase 3Wire			15193771	1200/577/1-1-1	1.758	NA	Director/D	
B.5791	North	KAPURTHALA	11KV	DS S/U DIVN. NAKODAR	DS S/D SHANKAR	D066FL05	Baluha	AMR	OK	31.03.2023	AP 3Phase 3Wire			9154417	900-450/577/1-1-1	1.772	NA	Director/D	
B.5792	North	KAPURTHALA	11KV	DS S/U DIVN. NAKODAR	DS S/D SHANKAR	D066FL08	Peerpur	AMR	OK	31.03.2023	AP 3Phase 3Wire			98834246	1200/577/1-1-1	1.939	NA	Director/D	
B.5793	North	KAPURTHALA	11KV	DS S/U DIVN. NAKODAR	DS S/D SHANKAR	D066FL13	JAGRAI ROAD	AMR	OK	31.03.2023	AP 3Phase 3Wire			98823792	900-450/577/1-1-1	1.954	NA	Director/D	
B.5794	North	KAPURTHALA	11KV	DS S/U DIVN. NAKODAR	DS S/D SHANKAR	D066FL07	Bopara	AMR	OK	31.03.2023	AP 3Phase 3Wire			9154374	1200/577/1-1-1	2.093	NA	Director/D	
B.5795	North	KAPURTHALA	11KV	DS S/U DIVN. NAKODAR	DS S/D SHANKAR	D066FL16	Tibba	AMR	OK	31.03.2023	AP 3Phase 3Wire			10281290	1200/577/1-1-1	2.200	NA	Director/D	
B.5796	North	KAPURTHALA	11KV	DS S/U DIVN. NAKODAR	DS S/D SHANKAR	D066FL02	Shankar	AMR	OK	31.03.2023	AP 3Phase 3Wire			8222903	900-450/577/1-1-1	2.290	NA	Director/D	
B.5797	North	KAPURTHALA	11KV	DS S/U DIVN. NAKODAR	DS S/D SHANKAR	D066FL14	GURRHA	AMR	OK	31.03.2023	AP 3Phase 3Wire			2046981	1200/577/1-1-1	2.510	NA	Director/D	
B.5798	North	KAPURTHALA	11KV	DS S/U DIVN. NAKODAR	DS S/D SHANKAR	D066FL09	Chaman	NON AMR	OK	31.03.2023	AP 3Phase 3Wire			33642	1200/577/1-1-1	2.821	NA	Director/D	
B.5799	North	KAPURTHALA	11KV	DS S/U DIVN. NAKODAR	DS S/D SHANKAR	D066FL11	Panjel	AMR	OK	31.03.2023	AP 3Phase 3Wire			23775	1200/577/1-1-1	2.865	NA	Director/D	
B.5800	North	KAPURTHALA	11KV	DS S/U DIVN. NAKODAR	DS S/D SHANKAR	D066FL06	Vendal	AMR	OK	31.03.2023	AP 3Phase 3Wire			9154430	1200/577/1-1-1	3.224	NA	Director/D	
B.5801	North	KAPURTHALA	11KV	DS S/U DIVN. NAKODAR	DS S/D SHANKAR	D066FL15	UPS Shelter Wala	AMR	OK	31.03.2023	Category 5-UPS			12093550	900-450/577/1-1-1	3.398	NA	Director/D	
B.5802	North	KAPURTHALA	11KV	DS S/U DIVN. NAKODAR	DS S/D SHANKAR	D0660019	CHANNIA UPS	NON AMR	OK	31.03.2023	Category 5-UPS			16198452	1200/577/1-1-1	5.509	NA	Director/D	
B.5803	North	KAPURTHALA	11KV	DS S/U DIVN. NAKODAR	DS S/D SHANKAR	D066FL01	URBAN Shankar	NON AMR	OK	31.03.2023	Category 1			5463595	900-450/577/1-1-1	5.528	NA	Director/D	
B.5804	North	KAPURTHALA	11KV	DS S/U DIVN. NAKODAR	DS S/D SHANKAR	D066FL12	UPS Saurth	AMR	OK	31.03.2023	Category 5-UPS			7338804	1200/577/1-1-1	8.122	NA	Director/D	
B.5805	North	KAPURTHALA	11KV	DS S/U DIVN. NAKODAR	DS S/U S/D NAKODAR	FL20C603	LITRAN	AMR	OK	31.03.2023	AP 3Phase 3Wire			8222722	1200-600/5	0.000	NA	Director/D	
B.5806	North	KAPURTHALA	11KV	DS S/U DIVN. NAKODAR	DS S/U S/D NAKODAR	C603FL04	Rangra	AMR	OK	31.03.2023	AP 3Phase 3Wire			9140931	1200-600/5	1.956	NA	Director/D	
B.5807	North	KAPURTHALA	11KV	DS S/U DIVN. NAKODAR	DS S/U S/D NAKODAR	C603FL02	Mipur	NON AMR	OK	31.03.2023	AP 3Phase 3Wire			9140934	1200-600/5	2.074	NA	Director/D	
B.5808	North	KAPURTHALA	11KV	DS S/U DIVN. NAKODAR	DS S/U S/D NAKODAR	C603FL12	Heran	AMR	OK	31.03.2023	AP 3Phase 3Wire			1	1200-600/5	2.240	NA	Director/D	
B.5809	North	KAPURTHALA	11KV	DS S/U DIVN. NAKODAR	DS S/U S/D NAKODAR	C603FL07	Sidhuwan	AMR	OK	31.03.2023	AP 3Phase 3Wire			9140933	1200-600/5	2.333	NA	Director/D	
B.5810	North	KAPURTHALA	11KV	DS S/U DIVN. NAKODAR	DS S/U S/D NAKODAR	C603FL01	GANDHARAN	AMR	OK	31.03.2023	AP 3Phase 3Wire			10282845	1200-600/5	2.485	NA	Director/D	
B.5811	North	KAPURTHALA	11KV	DS S/U DIVN. NAKODAR	DS S/U S/D NAKODAR	C603FL08	Sanghe Khalka	NON AMR	OK	31.03.2023	AP 3Phase 3Wire			8223734	1200-600/5	2.857	NA	Director/D	
B.5812	North	KAPURTHALA	11KV	DS S/U DIVN. NAKODAR	DS S/U S/D NAKODAR	C603FL03	Gohir	AMR	OK	31.03.2023	AP 3Phase 3Wire			9140872	1200-600/5	2.925	NA	Director/D	
B.5813	North	KAPURTHALA	11KV	DS S/U DIVN. NAKODAR	DS S/U S/D NAKODAR	C603FL16	Navan Pind	AMR	OK	31.03.2023	AP 3Phase 3Wire			8222722	1200-600/5	2.960	NA	Director/D	
B.5814	North	KAPURTHALA	11KV	DS S/U DIVN. NAKODAR	DS S/U S/D NAKODAR	C603FL23	Mahuwal	NON AMR	OK	31.03.2023	Category 5-UPS			9140872	1200-600/5	3.861	NA	Director/D	
B.5815	North	KAPURTHALA	11KV	DS S/U DIVN. NAKODAR	DS S/U S/D NAKODAR	C603FL05	UPS Main	AMR	OK	31.03.2023	Category 5-UPS			8223795	1200-600/5	10.711	NA	Director/D	
B.5816	North	KAPURTHALA	11KV	DS S/U DIVN. NAKODAR	DS S/U S/D NAKODAR	8602FL19	11 KV Sidhpapur	AMR	OK	31.03.2023	AP 3Phase 3Wire			2	900-450/577/1-1-1	2.015	NA	Director/D	
B.5817	North	KAPURTHALA	11KV	DS S/U DIVN. NAKODAR	DS S/U S/D NAKODAR	8602FL03	Hussianpur	AMR	OK	31.03.2023	AP 3Phase 3Wire			9140612	900-450/577/1-1-1	2.253	NA	Director/D	
B.5818	North	KAPURTHALA	11KV	DS S/U DIVN. NAKODAR	DS S/U S/D NAKODAR	8602FL01	Kotia Janga	AMR	OK	31.03.2023	AP 3Phase 3Wire			9140613	900-450/577/1-1-1	2.432	NA	Director/D	
B.5819	North	KAPURTHALA	11KV	DS S/U DIVN. NAKODAR	DS S/U S/D NAKODAR	8602FL02	Madha	AMR	OK	31.03.2023	AP 3Phase 3Wire			9140611	900-450/577/1-1-1	2.555	NA	Director/D	
B.5820	North	KAPURTHALA	11KV	DS S/U DIVN. NAKODAR	DS S/U S/D NAKODAR	8602FL20	Nagal Jwara	NON AMR	OK	31.03.2023	AP 3Phase 3Wire			7338866	900-450/577/1-1-1	2.875	NA	Director/D	
B.5821	North	KAPURTHALA	11KV	DS S/U DIVN. NAKODAR	DS S/U S/D NAKODAR	8602FL06	UPS Kotia Janga	AMR	OK	31.03.2023	Category 5-UPS			2365413	900-450/577/1-1-1	8.109	NA	Director/D	
B.5822	North	KAPURTHALA	11KV	DS S/U DIVN. NAKODAR	DS S/U S/D NAKODAR	8602FL15	ALEWALI SHEHRI	AMR	OK	31.03.2023	Category 1			8223228	900-450/577/1-1-1	0.993	NA	Director/D	
B.5823	North	KAPURTHALA	11KV	DS S/U DIVN. NAKODAR	DS S/U S/D NAKODAR	8602FL01	Gandra	AMR	OK	31.03.2023	AP 3Phase 3Wire			15193769	900-450/577/1-1-1	2.169	NA	Director/D	
B.5824	North	KAPURTHALA	11KV	DS S/U DIVN. NAKODAR	DS S/U S/D NAKODAR	D066FL08	Noorpur	AMR	OK	31.03.2023	AP 3Phase 3Wire			8223228	900-450/577/1-1-1	2.983	NA	Director/D	
B.5825	North	KAPURTHALA	11KV	DS S/U DIVN. NAKODAR	DS S/U S/D NAKODAR	D066FL14	UPS Sohail Khurd	AMR	OK	31.03.2023	Category 5-UPS			34435	900-450/577/1-1-1	5.674	NA	Director/D	
B.5826	North	KAPURTHALA	11KV	DS S/U DIVN. NAKODAR	DS S/U S/D NAKODAR	D066FL11	UPS Saurth	AMR	OK	31.03.2023	Category 5-UPS			9140530	900-450/577/1-1-1	6.235	NA	Director/D	
B.5827	North	KAPURTHALA	11KV	DS S/U DIVN. NAKODAR	DS S/U S/D NAKODAR	D04247	NAMAPIND	AMR	OK	31.03.2023	AP 3Phase 3Wire			16198447	1200/577/1-1-1	1.998	NA	Director/D	
B.5828	North	KAPURTHALA	11KV	DS S/U DIVN. NAKODAR	DS S/U S/D NAKODAR	064226	BIR PIND	AMR	OK	31.03.2023	AP 3Phase 3Wire			16194429	1200/577/1-1-1	3.000	NA	Director/D	
B.5829	North	KAPURTHALA	11KV	DS S/U DIVN. NAKODAR	DS S/U S/D NAKODAR	D066FL21	DARGABAD	AMR	OK	31.03.2023	AP 3Phase 3Wire			1	1200/577/1-1-1	1.418	NA	Director/D	
B.5830	North	KAPURTHALA	11KV	DS S/U DIVN. NAKODAR	DS S/U S/D NAKODAR	D066FL14	Kotia	AMR	OK	31.03.2023	AP 3Phase 3Wire			98836922	1200/577/1-1-1	2.293	NA	Director/D	
B.5831	North	KAPURTHALA	11KV	DS S/U DIVN. NAKODAR	DS S/U S/D NAKODAR	D066FL10	Paalpur	Not available	OK	31.03.2023	AP 3Phase 3Wire			4221029	1200/577/1-1-1	2.775	NA	Director/D	
B.5832	North	KAPURTHALA	6KV	DS S/U DIVN. NAKODAR	DS S/U S/D NAKODAR	D066FL12	Jashir Paper Mill	NON AMR	OK	31.03.2023	Category 4			Not available	Not available	18.122	NA	Director/D	
B.5833	North	NAWANSHAHR	11KV	DS DIVN. BANGA	DS S/D BEHRAM NO 1	D059FL16	11 KV DHAK	AMR	OK	31.03.2023	AP 3Phase 3Wire			12527359	900-450/5	1.560	NA	Director/D	
B.5834	North	NAWANSHAHR	11KV	DS DIVN. BANGA	DS S/D BEHRAM NO 1	D059FL09	Pharala	AMR	OK	31.03.2023	AP 3Phase 3Wire			9141132	900-450/5	1.772	NA	Director/D	
B.5835	North	NAWANSHAHR	11KV	DS DIVN. BANGA	DS S/D BEHRAM NO 1	D059FL10	Sandhwan	AMR	OK	31.03.2023	AP 3Phase 3Wire			8222875	900-450/5	2.149	NA	Director/D	
B.5836	North	NAWANSHAHR	11KV	DS DIVN. BANGA	DS S/D BEHRAM NO 1	D059FL08	Bisla	AMR	OK	31.03.2023	AP 3Phase 3Wire			4187897	900-450/5	2.604	NA	Director/D	
B.5837	North	NAWANSHAHR	11KV	DS DIVN. BANGA	DS S/D BEHRAM NO 1	D059FL06	Bahliana	AMR	OK	31.03.2023	AP 3Phase 3Wire			2066722	1200-600/5	2.002	NA	Director/D	
B.5838	North	NAWANSHAHR	11KV	DS DIVN. BANGA	DS S/D BEHRAM NO 1	D059FL07	City Behram	AMR	OK	31.03.2023	Category 1			6607243	1200-600/5	2.895	NA	Director/D	
B.5839	North	NAWANSHAHR	11KV	DS DIVN. BANGA	DS S/D BEHRAM NO 1	D059FL13	UPS-2	AMR	OK	31.03.2023	Category 5-UPS			10281294	1200-600/5	3.495	NA	Director/D	
B.5840	North	NAWANSHAHR	11KV	DS DIVN. BANGA	DS S/D BEHRAM NO 1	D059FL11	UPS-1	NON AMR	OK	31.03.2023	Category 5-UPS			12479411	900-450/5	4.266	NA	Director/D	
B.5841	North	NAWANSHAHR	11KV	DS DIVN. BANGA	DS S/D BEHRAM NO 1	D068FL06	11 KV Blakipur city	NON AMR	OK	31.03.2023	Category 1			12092467	900-450/5	0.774	NA	Director/D	
B.5842	North	NAWANSHAHR	11KV	DS DIVN. BANGA	DS S/D BEHRAM NO 1	D068FL03	11 KV Charan	NON AMR	OK	31.03.2023	AP 3Phase 3Wire			12092449	900-450/5	1.489	NA	Director/D	
B.5843	North	NAWANSHAHR	11KV	DS DIVN. BANGA	DS S/D BEHRAM NO 1	D068FL07	11 KV Charan	NON AMR	OK	31.03.2023	AP 3Phase 3Wire			12092489	900-450/5	1.547	NA	Director/D	
B.5844	North	NAWANSHAHR	11KV	DS DIVN. BANGA	DS S/D BEHRAM NO 1	D068FL10	JHANDERA	NON AMR	OK	31.03.2023	AP 3Phase 3Wire			3089	900-450/5	1.730	NA	Director/D	
B.5845	North	NAWANSHAHR	11KV	DS DIVN. BANGA	DS S/D BEHRAM NO 1	D068FL04	11 KV Mankan	NON AMR	OK	31.03.2023	AP 3Phase 3Wire			12092462	900-450/5	1.877	NA	Director/D	
B.5846	North	NAWANSHAHR	11KV	DS DIVN. BANGA	DS S/D BEHRAM NO 1	D068FL05	11 KV LUPS	AMR	OK	31.03.2023	Category 5-UPS			12092469	900-450/5	4.982	NA	Director/D	
B.5847	North	NAWANSHAHR	11KV	DS DIVN. BANGA	DS S/D BEHRAM NO 1	D067FL01	Manak City	AMR	OK	31.03.2023	Category 1			34440	1200-600/5	0.752	NA	Director/D	
B.5848	North	NAWANSHAHR	11KV	DS DIVN. BANGA	DS S/D BEHRAM NO 1	D067FL11	BHIMAN PUR	AMR	OK	31.03.2023	AP 3Phase 3Wire			73163719	1200-600/5	1.965	NA	Director/D	
B.5849	North	NAWANSHAHR	11KV	DS DIVN. BANGA	DS S/D BEHRAM NO 1	D067FL09	11 KV GHUMMANA	AMR	OK	31.03.2023	AP 3Phase 3Wire			16194372	1200-600/5	2.142	NA	Director/D	
B.5850	North	NAWANSHAHR	11KV	DS DIVN. BANGA	DS S/D BEHRAM NO 1	D067FL03	Deengian	AMR	OK	31.03.2023	AP 3Phase 3Wire			36926	1200-600/5	2.253	NA	Director/D	
B.5851	North	NAWANSHAHR	11KV	DS DIVN. BANGA	DS S/D BEHRAM NO 1	D067FL02	UPS Mangat	AMR	OK	31.03.2023	Category 5-UPS			36919	1200-600/5	4.440	NA	Director/D	
B.5852	North	NAWANSHAHR	11KV	DS DIVN. BANGA	DS S/D BEHRAM NO 2	D059FL21	BHARO MAJARA	AMR	OK	31.03.2023	AP 3Phase 3Wire			4547	900-450/5	1.510	NA	Director/D	
B.5853	North	NAWANSHAHR	11KV	DS DIVN. BANGA	DS S/D BEHRAM NO 2	D059FL19	11 KV MUNJANA	AMR	OK	31.03.2023	AP 3Phase 3Wire			33640	1200-600/5	1.730	NA	Director/D	
B.5854	North	NAWANSHAHR	11KV	DS DIVN. BANGA	DS S/D BEHRAM NO 2	D059FL18	11 KV CHAK GURU	AMR	OK	31.03.2023	AP 3Phase 3Wire			33322	900-450/5	1.953	NA		

S.No	Zone	Circle	Voltage Level (kVA)	Division (kVA)	Sub-Division (kVA)	Feeder ID	Feeder Name	Feeder Metering Status (Metered/unmetered/AMR/AMI)	Status of Meter (Functional/Non-Functional)	Metering Date	Date of last actual meter reading/communication	Feeder Type (Agr./Industrial/Mixed)	Status of Communication			Period from 01.04.2021 to 31.03.2022				Sales	Remarks (Source of data)
													% Data received through automatically if feeder AMR/AMI	Number of hours when meter was unable to communicate in week	Total Number of hours in the period	Meter S.No	CT/PT ratio	Import (kWh)	Export (kWh)		
B.5887	North	NAWANSHAH	11kV	DS DIVN. BANGA	DS S/D MUKANDPUR	D660FL13	Shukran	AMR	OK	31.03.2023		AP 3Phase 3Wire				12479583	900-450/5	2.705	NA	Director/D	
B.5888	North	NAWANSHAH	11kV	DS DIVN. BANGA	DS S/D MUKANDPUR	D660FL01	Khankhana	AMR	OK	31.03.2023		AP 3Phase 3Wire				9154308	900-450/5	2.760	NA	Director/D	
B.5889	North	NAWANSHAH	11kV	DS DIVN. BANGA	DS S/D MUKANDPUR	D660FL15	CHAHAK KALAN	NON AMR	OK	31.03.2023		AP 3Phase 3Wire				34070	900-450/5	2.775	NA	Director/D	
B.5890	North	NAWANSHAH	11kV	DS DIVN. BANGA	DS S/D MUKANDPUR	D660FL11	JAGATPUR	AMR	OK	31.03.2023		AP 3Phase 3Wire				9154063	1200-600/5	2.992	NA	Director/D	
B.5891	North	NAWANSHAH	11kV	DS DIVN. BANGA	DS S/D MUKANDPUR	D660FL17	KARNANA	AMR	OK	31.03.2023		AP 3Phase 3Wire				4078	900-450/5	2.997	NA	Director/D	
B.5892	North	NAWANSHAH	11kV	DS DIVN. BANGA	DS S/D MUKANDPUR	D660FL07	Retainda	NON AMR	OK	31.03.2023		AP 3Phase 3Wire				7042951	1200-600/5	3.475	NA	Director/D	
B.5893	North	NAWANSHAH	11kV	DS DIVN. BANGA	DS S/D MUKANDPUR	D660FL02	Mukandpur	AMR	OK	31.03.2023		Category 1				9154136	1200-600/5	4.116	NA	Director/D	
B.5894	North	NAWANSHAH	11kV	DS DIVN. BANGA	DS S/D MUKANDPUR	D660FL10	UJS No.3	NON AMR	OK	31.03.2023		Category 5-U/PS				9534363	1200-600/5	10.841	NA	Director/D	
B.5895	North	NAWANSHAH	11kV	DS DIVN. BANGA	DS S/D MUKANDPUR	D660FL08	UJS No.1	AMR	OK	31.03.2023		Category 5-U/PS				9534442	900-450/5	11.963	NA	Director/D	
B.5896	North	NAWANSHAH	11kV	DS DIVN. BANGA	DS S/D MUKANDPUR	D660FL09	UJS No. 2	NON AMR	OK	31.03.2023		Category 5-U/PS				9154392	1200-600/5	12.486	NA	Director/D	
B.5897	North	NAWANSHAH	11kV	DS DIVN. BANGA	DS S/U S/D BANGA	C652FL15	Solar Plant Khatkar Kalan	AMR	OK	31.03.2023		Category 5-U/PS				11117051	Not installed	1.356	NA	Director/D	
B.5898	North	NAWANSHAH	11kV	DS DIVN. BANGA	DS S/U S/D BANGA	C652FL11	SALLAN	AMR	OK	31.03.2023		AP 3Phase 3Wire				10273758	Not installed	1.621	NA	Director/D	
B.5899	North	NAWANSHAH	11kV	DS DIVN. BANGA	DS S/U S/D BANGA	C652FL07	Mahil Gehlan	AMR	OK	31.03.2023		AP 3Phase 3Wire				8222872	Not installed	2.654	NA	Director/D	
B.5900	North	NAWANSHAH	11kV	DS DIVN. BANGA	DS S/U S/D BANGA	C652FL08	Gobindpur	AMR	OK	31.03.2023		AP 3Phase 3Wire				8223528	Not installed	2.722	NA	Director/D	
B.5901	North	NAWANSHAH	11kV	DS DIVN. BANGA	DS S/U S/D BANGA	C652FL10	Naur	AMR	OK	31.03.2023		AP 3Phase 3Wire				8223470	Not installed	2.807	NA	Director/D	
B.5902	North	NAWANSHAH	11kV	DS DIVN. BANGA	DS S/U S/D BANGA	C652FL12	Ladhana Ucha	AMR	OK	31.03.2023		AP 3Phase 3Wire				45197	Not installed	2.891	NA	Director/D	
B.5903	North	NAWANSHAH	11kV	DS DIVN. BANGA	DS S/U S/D BANGA	C652FL05	Pashawa	AMR	OK	31.03.2023		AP 3Phase 3Wire				2068607	Not installed	3.172	NA	Director/D	
B.5904	North	NAWANSHAH	11kV	DS DIVN. BANGA	DS S/U S/D BANGA	C652FL06	Kahna	AMR	OK	31.03.2023		AP 3Phase 3Wire				8223468	Not installed	4.463	NA	Director/D	
B.5905	North	NAWANSHAH	11kV	DS DIVN. BANGA	DS S/U S/D BANGA	C652FL18	UJS No. 3	AMR	OK	31.03.2023		Category 5-U/PS				9154337	Not installed	6.067	NA	Director/D	
B.5906	North	NAWANSHAH	11kV	DS DIVN. BANGA	DS S/U S/D BANGA	C652FL23	11 KV UJS JHIKKA	NON AMR	OK	31.03.2023		Category 5-U/PS				15194799	Not installed	7.295	NA	Director/D	
B.5907	North	NAWANSHAH	11kV	DS DIVN. BANGA	DS S/U S/D BANGA	C652FL09	UJS No. 1	NON AMR	OK	31.03.2023		Category 5-U/PS				10281223	Not installed	12.258	NA	Director/D	
B.5908	North	NAWANSHAH	11kV	DS DIVN. BANGA	DS S/U S/D BANGA	D668FL01	Ladian	NON AMR	OK	31.03.2023		AP 3Phase 3Wire				12092461	900-450/5	2.043	NA	Director/D	
B.5909	North	NAWANSHAH	11kV	DS DIVN. BANGA	DS S/U S/D BANGA	D668FL02	Jandialia	AMR	OK	31.03.2023		AP 3Phase 3Wire				13190505	900-450/5	2.107	NA	Director/D	
B.5910	North	NAWANSHAH	11kV	DS DIVN. BANGA	DS S/U S/D BANGA	D666FL05	Sulion	AMR	OK	31.03.2023		AP 3Phase 3Wire				11116903	900-450/5	3.408	NA	Director/D	
B.5911	North	NAWANSHAH	11kV	DS DIVN. BANGA	DS S/U S/D BANGA	D665FL08	11 KV UJS BHOURA	AMR	OK	31.03.2023		Category 5-U/PS				15194828	900-450/577/1-1	3.515	NA	Director/D	
B.5912	North	NAWANSHAH	11kV	DS DIVN. GARHSHANKAR	S/D CITY GARHSHANKAR	D655FL10	BAJALA	AMR	OK	31.03.2023		Category 5-U/PS				3755	600-5/77/1-1	4.585	NA	Director/D	
B.5913	North	NAWANSHAH	11kV	DS DIVN. GARHSHANKAR	S/D CITY GARHSHANKAR	D655FL13	CHAIHRA	AMR	OK	31.03.2023		Kandi Pure AP				10282941	900-450/5	2.116	NA	Director/D	
B.5914	North	NAWANSHAH	11kV	DS DIVN. GARHSHANKAR	S/D CITY GARHSHANKAR	D655FL12	CIVIL HOSPITAL GARHSHANKAR	AMR	OK	31.03.2023		Category 1				37035	1200-600/5	0.197	NA	Director/D	
B.5915	North	NAWANSHAH	11kV	DS DIVN. GARHSHANKAR	S/D CITY GARHSHANKAR	D655FL16	TEHSIL COMPLEX CSR	AMR	OK	31.03.2023		Category 1				43241	900-450/5	1.725	NA	Director/D	
B.5916	North	NAWANSHAH	11kV	DS DIVN. GARHSHANKAR	S/D CITY GARHSHANKAR	D655FL17	Dagham	NON AMR	OK	31.03.2023		Kandi Pure AP				2066918	1200-600/5	4.033	NA	Director/D	
B.5917	North	NAWANSHAH	11kV	DS DIVN. GARHSHANKAR	S/D CITY GARHSHANKAR	D655FL07	BRAHMI PUR	AMR	OK	31.03.2023		Kandi Mixed				11117315	900-450/5	4.292	NA	Director/D	
B.5918	North	NAWANSHAH	11kV	DS DIVN. GARHSHANKAR	S/D CITY GARHSHANKAR	D655FL14	SHANDEPUR	NON AMR	OK	31.03.2023		Category 5-U/PS				3757	1200-600/5	6.045	NA	Director/D	
B.5919	North	NAWANSHAH	11kV	DS DIVN. GARHSHANKAR	S/D CITY GARHSHANKAR	D655FL04	PANAM	NON AMR	OK	31.03.2023		Kandi Mixed				11117248	900-450/5	6.237	NA	Director/D	
B.5920	North	NAWANSHAH	11kV	DS DIVN. GARHSHANKAR	S/D CITY GARHSHANKAR	D655FL10	CITY GARHSHANKAR-2	AMR	OK	31.03.2023		Category 1				11117188	1200-600/5	8.307	NA	Director/D	
B.5921	North	NAWANSHAH	11kV	DS DIVN. GARHSHANKAR	S/D CITY GARHSHANKAR	D655FL06	CITY GARHSHANKAR	Not available	OK	31.03.2023		Category 1				2068291	900-450/5	10.904	NA	Director/D	
B.5922	North	NAWANSHAH	11kV	DS DIVN. GARHSHANKAR	S/D CITY GARHSHANKAR	D655FL07	CHAUHRA	Not available	OK	31.03.2023		Kandi Mixed				Not available	Not available	1.203	NA	Director/D	
B.5923	North	NAWANSHAH	11kV	DS DIVN. GARHSHANKAR	S/D CITY GARHSHANKAR	D655FL08	DAGHAM	Not available	OK	31.03.2023		Kandi Mixed				Not available	Not available	2.267	NA	Director/D	
B.5924	North	NAWANSHAH	11kV	DS DIVN. GARHSHANKAR	S/D CITY-1 BALACHAUR	D655FL17	CIVIL HOSPITAL BALACHAUR	AMR	OK	31.03.2023		Category 1				15570	900-450/577/1-1	0.192	NA	Director/D	
B.5925	North	NAWANSHAH	11kV	DS DIVN. GARHSHANKAR	S/D CITY-1 BALACHAUR	D655FL21	MEHATPUR OLADANI	AMR	OK	31.03.2023		Kandi Pure AP				73185978	900-450/577/1-1	1.122	NA	Director/D	
B.5926	North	NAWANSHAH	11kV	DS DIVN. GARHSHANKAR	S/D CITY-1 BALACHAUR	D655FL10	SULOJWAL	NON AMR	OK	31.03.2023		AP 3Phase 3Wire				2068435	900-450/577/1-1	1.231	NA	Director/D	
B.5927	North	NAWANSHAH	11kV	DS DIVN. GARHSHANKAR	S/D CITY-1 BALACHAUR	D655FL23	BHARTHALA (GAHOON)	AMR	OK	31.03.2023		Kandi Pure AP				12093440	1200-600/5	1.714	NA	Director/D	
B.5928	North	NAWANSHAH	11kV	DS DIVN. GARHSHANKAR	S/D CITY-1 BALACHAUR	D655FL04	KANGNA	NON AMR	OK	31.03.2023		AP 3Phase 3Wire				23230	1200-600/5	1.816	NA	Director/D	
B.5929	North	NAWANSHAH	11kV	DS DIVN. GARHSHANKAR	S/D CITY-1 BALACHAUR	D655FL20	JALACHAUR	AMR	OK	31.03.2023		Kandi Pure AP				12093921	1200-600/5	4.531	NA	Director/D	
B.5930	North	NAWANSHAH	11kV	DS DIVN. GARHSHANKAR	S/D CITY-1 BALACHAUR	D655FL15	TEHSIL COMPLEX	AMR	OK	31.03.2023		Category 1				16198500	1200-600/5	5.177	NA	Director/D	
B.5931	North	NAWANSHAH	11kV	DS DIVN. GARHSHANKAR	S/D CITY-1 BALACHAUR	D655FL13	CITY BALACHAUR NO-2	AMR	OK	31.03.2023		Category 1				12093559	900-450/577/1-1	5.599	NA	Director/D	
B.5932	North	NAWANSHAH	11kV	DS DIVN. GARHSHANKAR	S/D CITY-1 BALACHAUR	D655FL18	MEHATPUR	AMR	OK	31.03.2023		Category 5-U/PS				3847	1200-600/5	5.931	NA	Director/D	
B.5933	North	NAWANSHAH	11kV	DS DIVN. GARHSHANKAR	S/D CITY-1 BALACHAUR	D655FL11	RAM NAGAR	NON AMR	OK	31.03.2023		Category 5-U/PS				12093994	900-450/577/1-1	5.999	NA	Director/D	
B.5934	North	NAWANSHAH	11kV	DS DIVN. GARHSHANKAR	S/D CITY-1 BALACHAUR	D655FL05	CHAUHRA	AMR	OK	31.03.2023		Kandi Mixed				12093544	900-450/5	6.066	NA	Director/D	
B.5935	North	NAWANSHAH	11kV	DS DIVN. GARHSHANKAR	S/D CITY-1 BALACHAUR	D655FL07	BALACHAUR	NON AMR	OK	31.03.2023		Category 1				2068336	900-450/577/1-1	11.239	NA	Director/D	
B.5936	North	NAWANSHAH	11kV	DS DIVN. GARHSHANKAR	S/D CITY-1 BALACHAUR	D657FL07	KARAWAR	AMR	OK	31.03.2023		Category 1				7042981	900-450/5	0.707	NA	Director/D	
B.5937	North	NAWANSHAH	11kV	DS DIVN. GARHSHANKAR	S/D CITY-1 BALACHAUR	D657FL12	RAKAR DHAHAN	NON AMR	OK	31.03.2023		Category 5-U/PS				3756	900-450/5	2.473	NA	Director/D	
B.5938	North	NAWANSHAH	11kV	DS DIVN. GARHSHANKAR	S/D CITY-1 BALACHAUR	D657FL13	JANPUR	AMR	OK	31.03.2023		Category 5-U/PS				6669542	900-450/5	3.133	NA	Director/D	
B.5939	North	NAWANSHAH	11kV	DS DIVN. GARHSHANKAR	S/D CITY-1 BALACHAUR	D657FL11	SHIBDA, MAJARA	AMR	OK	31.03.2023		Kandi Mixed				73151939	900-450/5	3.385	NA	Director/D	
B.5940	North	NAWANSHAH	11kV	DS DIVN. GARHSHANKAR	S/D CITY-1 BALACHAUR	D657FL09	MASARI	AMR	OK	31.03.2023		Kandi Mixed				2067769	900-450/5	4.436	NA	Director/D	
B.5941	North	NAWANSHAH	11kV	DS DIVN. GARHSHANKAR	S/D CITY-1 BALACHAUR	D657FL01	JADALI	AMR	OK	31.03.2023		Kandi Mixed				2067692	900-450/5	4.363	NA	Director/D	
B.5942	North	NAWANSHAH	11kV	DS DIVN. GARHSHANKAR	S/D CITY-1 BALACHAUR	D657FL03	KALUGARH	AMR	OK	31.03.2023		Kandi Mixed				2068493	900-450/5	6.454	NA	Director/D	
B.5943	North	NAWANSHAH	11kV	DS DIVN. GARHSHANKAR	S/D CITY-1 BALACHAUR	D657FL06	SARIBA	Not available	OK	31.03.2023		Kandi Mixed				2068192	900-450/5	6.619	NA	Director/D	
B.5944	North	NAWANSHAH	11kV	DS DIVN. GARHSHANKAR	S/D CITY-1 BALACHAUR	D655FL16	MEHATPUR OLADANI	Not available	OK	31.03.2023		Kandi Mixed				Not available	Not available	0.541	NA	Director/D	
B.5945	North	NAWANSHAH	11kV	DS DIVN. GARHSHANKAR	S/D CITY-1 BALACHAUR	D655FL03	BHARTHALA (GAHOON)	Not available	OK	31.03.2023		Kandi Mixed				Not available	Not available	0.923	NA	Director/D	
B.5946	North	NAWANSHAH	11kV	DS DIVN. GARHSHANKAR	S/D CITY-1 BALACHAUR	D657FL02	JANPUR	Not available	OK	31.03.2023		Kandi Mixed				Not available	Not available	1.453	NA	Director/D	
B.5947	North	NAWANSHAH	11kV	DS DIVN. GARHSHANKAR	S/D CITY-1 BALACHAUR	D655FL02	GARHI	AMR	OK	31.03.2023		Kandi Mixed				Not available	Not available	1.560	NA	Director/D	
B.5948	North	NAWANSHAH	11kV	DS DIVN. GARHSHANKAR	S/D CITY-2 BALACHAUR	C256FL11	TONSA	AMR	OK	31.03.2023		Kandi Mixed				6740912	Not installed	2.626	NA	Director/D	
B.5949	North	NAWANSHAH	11kV	DS DIVN. GARHSHANKAR	S/D CITY-2 BALACHAUR	C256FL18	BANNAH	AMR	OK	31.03.2023		Category 5-U/PS				2067868	Not installed	11.551	NA	Director/D	
B.5950	North	NAWANSHAH	11kV	DS DIVN. GARHSHANKAR	S/D CITY-2 BALACHAUR	D655FL22	LOHAT	AMR	OK	31.03.2023		Kandi Pure AP				16198500	900-450/577/1-1	1.647	NA	Director/D	
B.5951	North	NAWANSHAH	11kV	DS DIVN. GARHSHANKAR	S																

S.No	Zone	Circle	Voltage Level (kVA)	Division (kVA)	Sub-Division (kVA)	Feeder ID	Feeder Name	Feeder Metering Status (Metered/unmetered/AMR/AM)	Status of Meter (Functional/Non-Functional)	Metering Date	Date of last actual meter reading/communication	Feeder Type (Agr/Industrial/Mixed)	Status of Communication			Period from 01.04.2021 to 31.03.2022				Sales	Remarks (Source of data)
													% data received through automatically if feeder AMR/AM	Number of hours when meter was unable to communicate in overall	Total Number of hours in the period	Meter S.No	CT/PT ratio	Import (kWh)	Export (kWh)		
B.5984	North	NAWANSHAHAR	11KV	DS DIVN. GARISHANKAR	S/D SAROYA	D656FL07	DAYALAN	NON AMR	OK	31.03.2023		Kandi Mixed				9154459	900-450/5	8.320	NA	Director/D	
B.5985	North	NAWANSHAHAR	11KV	DS DIVN. GARISHANKAR	S/D SAROYA	D656FL04	MALEVAL	Not available	OK	31.03.2023		Kandi Mixed				9154036	900-450/5	14.821	NA	Director/D	
B.5986	North	NAWANSHAHAR	11KV	DS DIVN. GARISHANKAR	S/D SAROYA	D656FL02	SAMMUNDRA	Not available	OK	31.03.2023		Kandi Mixed				Not available	Not available	3.426	NA	Director/D	
B.5987	North	NAWANSHAHAR	11KV	DS DIVN. GARISHANKAR	S/D SAROYA	D656FL09	KUNAI	AMR	OK	31.03.2023		Kandi Mixed				1028835	900-450/577/1-1	4.893	NA	Director/D	
B.5988	North	NAWANSHAHAR	11KV	DS DIVN. GARISHANKAR	S/U S/D GARISHANKAR	D665FL10	MOLA WAHDIPUR	AMR	OK	31.03.2023		Category 1				1028835	900-450/577/1-1	1.187	NA	Director/D	
B.5989	North	NAWANSHAHAR	11KV	DS DIVN. GARISHANKAR	S/U S/D GARISHANKAR	D665FL12	BAJAJPUR	AMR	OK	31.03.2023		Kandi Pure AP				3041	900-450/577/1-1	2.029	NA	Director/D	
B.5990	North	NAWANSHAHAR	11KV	DS DIVN. GARISHANKAR	S/U S/D GARISHANKAR	D665FL11	BEDASERON	AMR	OK	31.03.2023		Kandi Pure AP				3232	900-450/577/1-1	2.196	NA	Director/D	
B.5991	North	NAWANSHAHAR	11KV	DS DIVN. GARISHANKAR	S/U S/D GARISHANKAR	D665FL06	FATEHPUR KHURD	AMR	OK	31.03.2023		Kandi Mixed				12093582	900-450/5	3.483	NA	Director/D	
B.5992	North	NAWANSHAHAR	11KV	DS DIVN. GARISHANKAR	S/U S/D GARISHANKAR	D665FL10	MALGARH	AMR	OK	31.03.2023		Category 5-UPS				3753	900-450/577/1-1	3.965	NA	Director/D	
B.5993	North	NAWANSHAHAR	11KV	DS DIVN. GARISHANKAR	S/U S/D GARISHANKAR	D665FL09	LALLAN	AMR	OK	31.03.2023		Category 5-UPS				3752	900-450/577/1-1	4.610	NA	Director/D	
B.5994	North	NAWANSHAHAR	11KV	DS DIVN. GARISHANKAR	S/U S/D GARISHANKAR	D665FL02	RAIPUR GUJRAN	NON AMR	OK	31.03.2023		Kandi Mixed				12093575	900-450/5	4.728	NA	Director/D	
B.5995	North	NAWANSHAHAR	11KV	DS DIVN. GARISHANKAR	S/U S/D GARISHANKAR	D665FL03	CHAHALPUR	AMR	OK	31.03.2023		Kandi Mixed				10282866	900-450/5	5.906	NA	Director/D	
B.5996	North	NAWANSHAHAR	11KV	DS DIVN. GARISHANKAR	S/U S/D GARISHANKAR	D655FL13	BHAJJAL	AMR	OK	31.03.2023		Kandi Mixed				15194757	1200-600/5	3.623	NA	Director/D	
B.5997	North	NAWANSHAHAR	11KV	DS DIVN. GARISHANKAR	S/U S/D GARISHANKAR	D655FL11	BIHAMPUR	NON AMR	OK	31.03.2023		Kandi Mixed				11117319	1200-600/5	6.068	NA	Director/D	
B.5998	North	NAWANSHAHAR	11KV	DS DIVN. GARISHANKAR	S/U S/D GARISHANKAR	D655FL09	SHAMPUR	AMR	OK	31.03.2023		Kandi Mixed				2067138	1200-600/5	6.341	NA	Director/D	
B.5999	North	NAWANSHAHAR	11KV	DS DIVN. GARISHANKAR	S/U S/D GARISHANKAR	D655FL15	DUGRI	AMR	OK	31.03.2023		Category 5-UPS				3754	1200-600/5	6.966	NA	Director/D	
B.6000	North	NAWANSHAHAR	11KV	DS DIVN. GARISHANKAR	S/U S/D GARISHANKAR	D655FL05	SADHOVAL	NON AMR	OK	31.03.2023		Kandi Mixed				11117264	1200-600/5	9.960	NA	Director/D	
B.6001	North	NAWANSHAHAR	11KV	DS DIVN. GARISHANKAR	S/U S/D GARISHANKAR	D671FL01	KITNA	NON AMR	OK	31.03.2023		Kandi Mixed				7336800	900-450/577/1-1	9.137	NA	Director/D	
B.6002	North	NAWANSHAHAR	11KV	DS DIVN. GARISHANKAR	S/U S/D GARISHANKAR	D718FL03	HAZIPUR	AMR	OK	31.03.2023		Kandi Mixed				7035657	900-450/577/1-1	11.291	NA	Director/D	
B.6003	North	NAWANSHAHAR	11KV	DS DIVN. GARISHANKAR	SUB OFFICE BINEVAL	D571FL06	DALLEVAL URBAN	AMR	OK	31.03.2023		Category 1				15103869	900-450/5	1.374	NA	Director/D	
B.6004	North	NAWANSHAHAR	11KV	DS DIVN. GARISHANKAR	SUB OFFICE BINEVAL	D671FL05	BHAWANIPUR	AMR	OK	31.03.2023		Kandi Mixed				43171	900-450/5	4.796	NA	Director/D	
B.6005	North	NAWANSHAHAR	11KV	DS DIVN. GARISHANKAR	SUB OFFICE BINEVAL	D671FL04	ACHALPUR	AMR	OK	31.03.2023		Kandi Mixed				43181	900-450/5	5.992	NA	Director/D	
B.6006	North	NAWANSHAHAR	11KV	DS DIVN. GARISHANKAR	SUB OFFICE BINEVAL	D671FL03	PANDORI	AMR	OK	31.03.2023		Kandi Mixed				43131	900-450/5	6.478	NA	Director/D	
B.6007	North	NAWANSHAHAR	11KV	DS DIVN. GARISHANKAR	SUB OFFICE BINEVAL	D671FL02	JHUNGI	NON AMR	OK	31.03.2023		Kandi Mixed				43212	900-450/5	7.568	NA	Director/D	
B.6008	North	NAWANSHAHAR	11KV	DS DIVN. GARISHANKAR	SUB OFFICE BINEVAL	D655FL06	BINEVAL	AMR	OK	31.03.2023		Kandi Mixed				9154253	900-450/5	2.078	NA	Director/D	
B.6009	North	NAWANSHAHAR	11KV	DS DIVN. GORAYA	S/D APRA	D666FL06	Gan	AMR	OK	31.03.2023		AP 3Phase 3Wire				4187916	900-450/5	1.917	NA	Director/D	
B.6010	North	NAWANSHAHAR	11KV	DS DIVN. GORAYA	S/D APRA	D666FL08	Lasara	AMR	OK	31.03.2023		AP 3Phase 3Wire				8222702	900-450/5	2.156	NA	Director/D	
B.6011	North	NAWANSHAHAR	11KV	DS DIVN. GORAYA	S/D APRA	D666FL10	Khanpur	AMR	OK	31.03.2023		AP 3Phase 3Wire				7336687	900-450/5	2.636	NA	Director/D	
B.6012	North	NAWANSHAHAR	11KV	DS DIVN. GORAYA	S/D APRA	D666FL01	Chokan	AMR	OK	31.03.2023		AP 3Phase 3Wire				8222701	900-450/5	2.748	NA	Director/D	
B.6013	North	NAWANSHAHAR	11KV	DS DIVN. GORAYA	S/D APRA	D666FL02	Nagar	AMR	OK	31.03.2023		AP 3Phase 3Wire				8222704	900-450/5	3.024	NA	Director/D	
B.6014	North	NAWANSHAHAR	11KV	DS DIVN. GORAYA	S/D APRA	D666FL09	Dyal pur	AMR	OK	31.03.2023		AP 3Phase 3Wire				8222705	900-450/5	3.084	NA	Director/D	
B.6015	North	NAWANSHAHAR	11KV	DS DIVN. GORAYA	S/D APRA	D666FL11	Cheema Khurd	AMR	OK	31.03.2023		AP 3Phase 3Wire				6761928	900-450/5	3.125	NA	Director/D	
B.6016	North	NAWANSHAHAR	11KV	DS DIVN. GORAYA	S/D APRA	D666FL04	Samrai	NON AMR	OK	31.03.2023		AP 3Phase 3Wire				5437717	900-450/5	3.384	NA	Director/D	
B.6017	North	NAWANSHAHAR	11KV	DS DIVN. GORAYA	S/D APRA	D666FL07	Urban Pattern	AMR	OK	31.03.2023		Category 5-UPS				9154222	900-450/5	9.411	NA	Director/D	
B.6018	North	NAWANSHAHAR	11KV	DS DIVN. GORAYA	S/D APRA	D666FL03	Agra	AMR	OK	31.03.2023		Category 1				9140688	900-450/5	13.428	NA	Director/D	
B.6019	North	NAWANSHAHAR	11KV	DS DIVN. GORAYA	S/D APRA	D666FL07	Bansian Dhak	NON AMR	OK	31.03.2023		Category 1				12479648	900-450/5	0.576	NA	Director/D	
B.6020	North	NAWANSHAHAR	11KV	DS DIVN. GORAYA	S/D APRA	D666FL08	Bhansinghpur	AMR	OK	31.03.2023		AP 3Phase 3Wire				12062452	900-450/5	1.465	NA	Director/D	
B.6021	North	NAWANSHAHAR	11KV	DS DIVN. GORAYA	S/D APRA	D666FL06	Thala	AMR	OK	31.03.2023		AP 3Phase 3Wire				9534531	900-450/5	2.122	NA	Director/D	
B.6022	North	NAWANSHAHAR	11KV	DS DIVN. GORAYA	S/D APRA	D666FL10	Ashahor AP	AMR	OK	31.03.2023		AP 3Phase 3Wire				3917	900-450/5	2.130	NA	Director/D	
B.6023	North	NAWANSHAHAR	11KV	DS DIVN. GORAYA	S/D APRA	D666FL05	Salkiana	AMR	OK	31.03.2023		AP 3Phase 3Wire				12479798	900-450/5	2.755	NA	Director/D	
B.6024	North	NAWANSHAHAR	11KV	DS DIVN. GORAYA	S/D APRA	D666FL01	Kadiana	AMR	OK	31.03.2023		AP 3Phase 3Wire				2066540	900-450/5	2.912	NA	Director/D	
B.6025	North	NAWANSHAHAR	11KV	DS DIVN. GORAYA	S/D APRA	D666FL02	Puri	AMR	OK	31.03.2023		AP 3Phase 3Wire				8222584	900-450/5	3.336	NA	Director/D	
B.6026	North	NAWANSHAHAR	11KV	DS DIVN. GORAYA	S/D APRA	D666FL11	11KV UPS RAIPUR ARRIYAN	AMR	OK	31.03.2023		Category 5-UPS				4191	900-450/5	12.822	NA	Director/D	
B.6027	North	NAWANSHAHAR	11KV	DS DIVN. GORAYA	S/D APRA	D666FL04	Urban Pattern	NON AMR	OK	31.03.2023		Category 5-UPS				12092487	900-450/5	5.527	NA	Director/D	
B.6028	North	NAWANSHAHAR	11KV	DS DIVN. GORAYA	S/D APRA	D666FL09	UPS Katalpan	AMR	OK	31.03.2023		Category 5-UPS				12092483	900-450/5	8.488	NA	Director/D	
B.6029	North	NAWANSHAHAR	11KV	DS DIVN. GORAYA	S/D CITY GORAYA	B651FL05	AIR-2	AMR	OK	31.03.2023		Category 4				6669393	Not installed	0.911	NA	Director/D	
B.6030	North	NAWANSHAHAR	11KV	DS DIVN. GORAYA	S/D CITY GORAYA	B651FL12	AIR-1	AMR	OK	31.03.2023		Category 4				6669354	Not installed	1.072	NA	Director/D	
B.6031	North	NAWANSHAHAR	11KV	DS DIVN. GORAYA	S/D CITY GORAYA	B651FL14	Nawan Pind	AMR	OK	31.03.2023		AP 3Phase 3Wire				8228370	Not installed	3.266	NA	Director/D	
B.6032	North	NAWANSHAHAR	11KV	DS DIVN. GORAYA	S/D CITY GORAYA	B651FL21	Mansarpur AP	NON AMR	OK	31.03.2023		AP 3Phase 3Wire				8441	Not installed	2.117	NA	Director/D	
B.6033	North	NAWANSHAHAR	11KV	DS DIVN. GORAYA	S/D CITY GORAYA	B651FL18	ATI	NON AMR	OK	31.03.2023		AP 3Phase 3Wire				10281229	Not installed	2.337	NA	Director/D	
B.6034	North	NAWANSHAHAR	11KV	DS DIVN. GORAYA	S/D CITY GORAYA	B651FL17	Amrit Industry	NON AMR	OK	31.03.2023		Category 4				10273764	Not installed	3.711	NA	Director/D	
B.6035	North	NAWANSHAHAR	11KV	DS DIVN. GORAYA	S/D CITY GORAYA	B651FL04	City-2	NON AMR	OK	31.03.2023		Category 1				5343322	Not installed	10.421	NA	Director/D	
B.6036	North	NAWANSHAHAR	11KV	DS DIVN. GORAYA	S/D CITY GORAYA	B651FL13	C.T. Road	NON AMR	OK	31.03.2023		Category 1				6486574	Not installed	11.536	NA	Director/D	
B.6037	North	NAWANSHAHAR	11KV	DS DIVN. GORAYA	S/D CITY GORAYA	B651FL08	City-1	NON AMR	OK	31.03.2023		Category 1				6486575	Not installed	11.822	NA	Director/D	
B.6038	North	NAWANSHAHAR	11KV	DS DIVN. GORAYA	S/D CITY GORAYA	D666FL11	Dosanjh Khurd	AMR	OK	31.03.2023		Category 5-UPS				23421	900-450/5	1.162	NA	Director/D	
B.6039	North	NAWANSHAHAR	11KV	DS DIVN. GORAYA	S/D CITY GORAYA	D666FL04	Kutewal	AMR	OK	31.03.2023		AP 3Phase 3Wire				2994165	Not installed	2.038	NA	Director/D	
B.6040	North	NAWANSHAHAR	11KV	DS DIVN. GORAYA	S/D PHILLAUR	C653FL04	Tehng	AMR	OK	31.03.2023		AP 3Phase 3Wire				9154031	Not installed	0.000	NA	Director/D	
B.6041	North	NAWANSHAHAR	11KV	DS DIVN. GORAYA	S/D PHILLAUR	C653FL12	Court Complex	AMR	OK	31.03.2023		Category 4				9534424	900-450/577/1-1	0.234	NA	Director/D	
B.6042	North	NAWANSHAHAR	11KV	DS DIVN. GORAYA	S/D PHILLAUR	C653FL16	Rasulp														

S.No	Zone	Circle	Voltage (kVA)	Division (kVA)	Sub-Division (kVA)	Feeder ID	Feeder Name	Feeder Metering Status (Metered/unmetered/AMR/AMI)	Status of Meter (Functional/Non-Functional)	Metering Date (Date of last actual meter reading/communication)	Feeder Type (Agr/Industrial/Mixed)	Status of Communication			Period from 01.04.2021 to 31.03.2022				Sales	Remarks (Source of data)
												% data received through automatically by feeder AMR/AMI	Number of hours when meter was unable to communicate in overall	Total Number of hours in the period	Meter S.No	CT/PT ratio	Import (kU)	Export (kU)		
B.6081	North	NAWANSHAH	11KV	DS DIVN. GORAYA	DS S/D RURKA KALAN	D663FL01	Paala	AMR	OK	31.03.2023	AP 3Phase 3Wire				13190520	900-450/5	2,898	NA	Director/D	
B.6082	North	NAWANSHAH	11KV	DS DIVN. GORAYA	DS S/D RURKA KALAN	D663FL06	Roopwadi	NON AMR	OK	31.03.2023	AP 3Phase 3Wire				91541133	900-450/5	2,915	NA	Director/D	
B.6083	North	NAWANSHAH	11KV	DS DIVN. GORAYA	DS S/D RURKA KALAN	D663FL15	NARGA	AMR	OK	31.03.2023	AP 3Phase 3Wire				11116956	900-450/5	2,915	NA	Director/D	
B.6084	North	NAWANSHAH	11KV	DS DIVN. GORAYA	DS S/D RURKA KALAN	D663FL13	Dheensur	AMR	OK	31.03.2023	AP 3Phase 3Wire				3134559	900-450/5	2,977	NA	Director/D	
B.6085	North	NAWANSHAH	11KV	DS DIVN. GORAYA	DS S/D RURKA KALAN	D663FL07	Sing Dhesan	NON AMR	OK	31.03.2023	AP 3Phase 3Wire				8223833	900-450/5	3,128	NA	Director/D	
B.6086	North	NAWANSHAH	11KV	DS DIVN. GORAYA	DS S/D RURKA KALAN	D663FL17	DHANDA	AMR	OK	31.03.2023	AP 3Phase 3Wire				11117324	900-450/5	3,133	NA	Director/D	
B.6087	North	NAWANSHAH	11KV	DS DIVN. GORAYA	DS S/D RURKA KALAN	D663FL02	Rurki	AMR	OK	31.03.2023	AP 3Phase 3Wire				2994163	900-450/5	3,162	NA	Director/D	
B.6088	North	NAWANSHAH	11KV	DS DIVN. GORAYA	DS S/D RURKA KALAN	D663FL04	Kahna Dhesan	AMR	OK	31.03.2023	Category 1				9141175	900-450/5	3,279	NA	Director/D	
B.6089	North	NAWANSHAH	11KV	DS DIVN. GORAYA	DS S/D RURKA KALAN	D663FL05	Randhwa	AMR	OK	31.03.2023	Category 5-U/PS				13190548	900-450/5	6,064	NA	Director/D	
B.6090	North	NAWANSHAH	11KV	DS DIVN. GORAYA	DS S/D RURKA KALAN	D663FL18	Dandwadi	NON AMR	OK	31.03.2023	Category 5-U/PS				37084	900-450/5	6,130	NA	Director/D	
B.6091	North	NAWANSHAH	11KV	DS DIVN. GORAYA	DS S/D RURKA KALAN	D663FL10	Rurka Kalan	Not available	OK	31.03.2023	Category 1				9153607	900-450/5	6,596	NA	Director/D	
B.6092	North	NAWANSHAH	66KV	DS DIVN. GORAYA	DS S/D RURKA KALAN	D664DL01	GMA Udyog Ltd (66 KV)	AMR	OK	31.03.2023	Category 4				Not available	Not available	4,512	NA	Director/D	
B.6093	North	NAWANSHAH	11KV	DS DIVN. GORAYA	DS S/U S/D GORAYA	8651FL10	Paddi jagir	AMR	OK	31.03.2023	AP 3Phase 3Wire				8223738	Not installed	1,947	NA	Director/D	
B.6094	North	NAWANSHAH	11KV	DS DIVN. GORAYA	DS S/U S/D GORAYA	8651FL01	Chadhari	AMR	OK	31.03.2023	AP 3Phase 3Wire				8223739	Not installed	2,246	NA	Director/D	
B.6095	North	NAWANSHAH	11KV	DS DIVN. GORAYA	DS S/U S/D GORAYA	8651FL16	Dhuleta	AMR	OK	31.03.2023	AP 3Phase 3Wire				8223640	Not installed	2,687	NA	Director/D	
B.6096	North	NAWANSHAH	11KV	DS DIVN. GORAYA	DS S/U S/D GORAYA	8651FL09	Johal	AMR	OK	31.03.2023	AP 3Phase 3Wire				8223736	Not installed	2,853	NA	Director/D	
B.6097	North	NAWANSHAH	11KV	DS DIVN. GORAYA	DS S/U S/D GORAYA	8651FL20	Lallan	AMR	OK	31.03.2023	AP 3Phase 3Wire				34006	Not installed	2,878	NA	Director/D	
B.6098	North	NAWANSHAH	11KV	DS DIVN. GORAYA	DS S/U S/D GORAYA	8651FL06	Mahal	AMR	OK	31.03.2023	AP 3Phase 3Wire				8223885	Not installed	3,513	NA	Director/D	
B.6099	North	NAWANSHAH	11KV	DS DIVN. GORAYA	DS S/U S/D GORAYA	8651FL14	Rajpura	NON AMR	OK	31.03.2023	AP 3Phase 3Wire				8223737	Not installed	3,598	NA	Director/D	
B.6100	North	NAWANSHAH	11KV	DS DIVN. GORAYA	DS S/U S/D GORAYA	8651FL15	Phigwara road	AMR	OK	31.03.2023	Category 5-U/PS				4187161	Not installed	6,623	NA	Director/D	
B.6101	North	NAWANSHAH	11KV	DS DIVN. GORAYA	DS S/U S/D GORAYA	8651FL02	Chit Thothar	AMR	OK	31.03.2023	AP 3Phase 3Wire				6740724	Not installed	9,717	NA	Director/D	
B.6102	North	NAWANSHAH	11KV	DS DIVN. GORAYA	DS S/U S/D GORAYA	8651FL19	Mauli	AMR	OK	31.03.2023	Category 1				36837	Not installed	10,236	NA	Director/D	
B.6103	North	NAWANSHAH	11KV	DS DIVN. GORAYA	DS S/U S/D GORAYA	8651FL07	Bara Pind	AMR	OK	31.03.2023	Category 1				6486572	Not installed	15,516	NA	Director/D	
B.6104	North	NAWANSHAH	11KV	DS DIVN. GORAYA	DS S/U S/D GORAYA	D662FL13	Tibbi AP	AMR	OK	31.03.2023	AP 3Phase 3Wire				5499	900-450/5	1,438	NA	Director/D	
B.6105	North	NAWANSHAH	11KV	DS DIVN. GORAYA	DS S/U S/D GORAYA	D662FL05	GMA Jamalpur	AMR	OK	31.03.2023	Category 4				12479543	900-450/5	19,088	NA	Director/D	
B.6106	North	NAWANSHAH	11KV	DS DIVN. GORAYA	DS S/U S/D GORAYA	D663FL13	Chit Thothar	AMR	OK	31.03.2023	AP 3Phase 3Wire				24364	900-450/5	2,976	NA	Director/D	
B.6107	North	NAWANSHAH	11KV	DS DIVN. GORAYA	DS S/U S/D GORAYA	D663FL08	Gurka	AMR	OK	31.03.2023	AP 3Phase 3Wire				2068392	900-450/5	3,412	NA	Director/D	
B.6108	North	NAWANSHAH	11KV	DS DIVN. GORAYA	SUB OFFICE DOSANJH KALAN	D662FL12	Dosanjh AP	AMR	OK	31.03.2023	AP 3Phase 3Wire				73211266	900-450/5	1,350	NA	Director/D	
B.6109	North	NAWANSHAH	11KV	DS DIVN. GORAYA	SUB OFFICE DOSANJH KALAN	D662FL02	Nano majara	AMR	OK	31.03.2023	AP 3Phase 3Wire				7336402	900-450/5	1,858	NA	Director/D	
B.6110	North	NAWANSHAH	11KV	DS DIVN. GORAYA	SUB OFFICE DOSANJH KALAN	D662FL04	VIRK	AMR	OK	31.03.2023	AP 3Phase 3Wire				8222852	900-450/5	1,864	NA	Director/D	
B.6111	North	NAWANSHAH	11KV	DS DIVN. GORAYA	SUB OFFICE DOSANJH KALAN	D662FL11	Lajo Mijara AP	AMR	OK	31.03.2023	AP 3Phase 3Wire				7311287	900-450/5	2,016	NA	Director/D	
B.6112	North	NAWANSHAH	11KV	DS DIVN. GORAYA	SUB OFFICE DOSANJH KALAN	D662FL03	Gurha	AMR	OK	31.03.2023	AP 3Phase 3Wire				8141106	900-450/5	2,485	NA	Director/D	
B.6113	North	NAWANSHAH	11KV	DS DIVN. GORAYA	SUB OFFICE DOSANJH KALAN	D662FL08	Meera Pur	AMR	OK	31.03.2023	AP 3Phase 3Wire				5341629	900-450/5	2,568	NA	Director/D	
B.6114	North	NAWANSHAH	11KV	DS DIVN. GORAYA	SUB OFFICE DOSANJH KALAN	D662FL06	Kotli	AMR	OK	31.03.2023	AP 3Phase 3Wire				7030200	900-450/5	2,778	NA	Director/D	
B.6115	North	NAWANSHAH	11KV	DS DIVN. GORAYA	SUB OFFICE DOSANJH KALAN	D662FL07	Chakdesraj	AMR	OK	31.03.2023	AP 3Phase 3Wire				2047162	900-450/5	2,822	NA	Director/D	
B.6116	North	NAWANSHAH	11KV	DS DIVN. GORAYA	SUB OFFICE DOSANJH KALAN	D662FL09	Urban Pattern UPS	NON AMR	OK	31.03.2023	Category 5-U/PS				2066474	900-450/5	6,060	NA	Director/D	
B.6117	North	NAWANSHAH	11KV	DS DIVN. GORAYA	SUB OFFICE DOSANJH KALAN	D662FL01	Dusanj UPS	AMR	OK	31.03.2023	Category 5-U/PS				2068466	900-450/5	11,043	NA	Director/D	
B.6118	North	NAWANSHAH	11KV	DS DIVN. NAWANSHAH	DS S/D AUR	D663FL07	PANDRAWAL	AMR	OK	31.03.2023	AP 3Phase 3Wire				8222693	900-450/577/1-1	1,822	NA	Director/D	
B.6119	North	NAWANSHAH	11KV	DS DIVN. NAWANSHAH	DS S/D AUR	D663FL18	Fambra	NON AMR	OK	31.03.2023	AP 3Phase 3Wire				11117138	900-450/577/1-1	1,881	NA	Director/D	
B.6120	North	NAWANSHAH	11KV	DS DIVN. NAWANSHAH	DS S/D AUR	D652FL14	SAHLON	AMR	OK	31.03.2023	AP 3Phase 3Wire				11116766	900-450/577/1-1	2,319	NA	Director/D	
B.6121	North	NAWANSHAH	11KV	DS DIVN. NAWANSHAH	DS S/D AUR	D652FL13	METHRAMPUR	AMR	OK	31.03.2023	AP 3Phase 3Wire				778120	900-450/577/1-1	2,455	NA	Director/D	
B.6122	North	NAWANSHAH	11KV	DS DIVN. NAWANSHAH	DS S/D AUR	D663FL02	MIRPUR LA AKHA	AMR	OK	31.03.2023	AP 3Phase 3Wire				8222867	900-450/577/1-1	2,709	NA	Director/D	
B.6123	North	NAWANSHAH	11KV	DS DIVN. NAWANSHAH	DS S/D AUR	D663FL15	AMR	OK	31.03.2023	AP 3Phase 3Wire				8222691	900-450/577/1-1	2,769	NA	Director/D		
B.6124	North	NAWANSHAH	11KV	DS DIVN. NAWANSHAH	DS S/D AUR	D663FL03	GARCHA	AMR	OK	31.03.2023	AP 3Phase 3Wire				1117223	900-450/577/1-1	2,779	NA	Director/D	
B.6125	North	NAWANSHAH	11KV	DS DIVN. NAWANSHAH	DS S/D AUR	D663FL09	TALPUR	AMR	OK	31.03.2023	AP 3Phase 3Wire				8222692	900-450/577/1-1	2,969	NA	Director/D	
B.6126	North	NAWANSHAH	11KV	DS DIVN. NAWANSHAH	DS S/D AUR	D663FL16	CHAKDANA	AMR	OK	31.03.2023	AP 3Phase 3Wire				6607652	900-450/577/1-1	3,208	NA	Director/D	
B.6127	North	NAWANSHAH	11KV	DS DIVN. NAWANSHAH	DS S/D AUR	D663FL20	BURATFALDAS	NON AMR	OK	31.03.2023	Category 5-U/PS				599812	900-450/577/1-1	4,678	NA	Director/D	
B.6128	North	NAWANSHAH	11KV	DS DIVN. NAWANSHAH	DS S/D AUR	D663FL08	KOHPUR	AMR	OK	31.03.2023	Category 5-U/PS				12479757	900-450/577/1-1	6,064	NA	Director/D	
B.6129	North	NAWANSHAH	11KV	DS DIVN. NAWANSHAH	DS S/D AUR	D652D652	AUR	NON AMR	OK	31.03.2023	Category 1				1247839	900-450/577/1-1	5,091	NA	Director/D	
B.6130	North	NAWANSHAH	11KV	DS DIVN. NAWANSHAH	DS S/D AUR	D652FL11	KHOJA	NON AMR	OK	31.03.2023	Category 5-U/PS				5388157	900-450/577/1-1	6,044	NA	Director/D	
B.6131	North	NAWANSHAH	11KV	DS DIVN. NAWANSHAH	DS S/D AUR	D652FL17	MALPUR	AMR	OK	31.03.2023	Category 5-U/PS				11117123	900-450/577/1-1	7,558	NA	Director/D	
B.6132	North	NAWANSHAH	11KV	DS DIVN. NAWANSHAH	DS S/D CITY NAWANSHAH	C651FL09	FOCAL POINT	AMR	OK	31.03.2023	Category 1				6669374	1200-600/5	0,043	NA	Director/D	
B.6133	North	NAWANSHAH	11KV	DS DIVN. NAWANSHAH	DS S/D CITY NAWANSHAH	C651FL07	SUGER MILL	AMR	OK	31.03.2023	Category 2				2068003	1200-600/5	0,048	NA	Director/D	
B.6134	North	NAWANSHAH	11KV	DS DIVN. NAWANSHAH	DS S/D CITY NAWANSHAH	C651FL13	Chandigarh Road	AMR	OK	31.03.2023	Category 1				1217472	1200-600/5	10,494	NA	Director/D	
B.6135	North	NAWANSHAH	11KV	DS DIVN. NAWANSHAH	DS S/D CITY NAWANSHAH	C651FL02	CITY 11	AMR	OK	31.03.2023	Category 1				2047139	1200-600/5	13,511	NA	Director/D	
B.6136	North	NAWANSHAH	11KV	DS DIVN. NAWANSHAH	DS S/D CITY NAWANSHAH	D673FL06	11 KV Civil Hospital	AMR	OK	31.03.2023	Category 4				2515	400-200/5	0,577	NA	Director/D	
B.6137	North	NAWANSHAH	11KV	DS DIVN. NAWANSHAH	DS S/D CITY NAWANSHAH	D673FL14	Barnala Gate	AMR	OK	31.03.2023	Category 1				2545	400-200/5	3,605	NA	Director/D	
B.6138	North	NAWANSHAH	11KV	DS DIVN. NAWANSHAH	DS S/D CITY NAWANSHAH	D673FL13	Saloh Road	AMR	OK	31.03.2023	Category 1				2531	400-200/5	4,289	NA	Director/D	
B.6139	North	NAWANSHAH	11KV	DS DIVN. NAWANSHAH	DS S/D CITY NAWANSHAH	D673FL08	11 KV Begam Pur	AMR	OK											

S.No	Zone	Circle	Voltage (kVA)	Division (kVA)	Sub-Division (kVA)	Feeder ID	Feeder Name	Feeder Metering Status (Metered/unmetered/AMR/AMI)	Status of Meter (Functional/Non-Functional)	Metering Date (Date of last actual meter reading/communication)	Feeder Type (Agr/Industrial/Mixed)	Status of Communication			Period from 01.04.2021 to 31.03.2022				Sales	Remarks (Source of data)
												% data received through automatically if feeder AMR/AMI	Number of hours when meter was unable to communicate in week	Total Number of hours in the period	Meter S.No	CT/PT ratio	Import (kWh)	Export (kWh)		
B.6178	North	NAWANSHAHR	11KV	DS DIVN. NAWANSHAHR	DS S/D RAHON	0633FL10	SEL FACTORY	AMR	OK	31.03.2023	Category 4				2068523	900-450/5	15.053	NA	Director/D	
B.6179	North	NAWANSHAHR	11KV	DS DIVN. NAWANSHAHR	DS S/U S/D NAWANSHAHR	C653FL17	11KV AMARGARH	AMR	OK	31.03.2023	AP 3Phase 3Wire				6740743	1200-600/5	0.639	NA	Director/D	
B.6180	North	NAWANSHAHR	11KV	DS DIVN. NAWANSHAHR	DS S/U S/D NAWANSHAHR	C653FL16	11KV ALUPUR	AMR	OK	31.03.2023	AP 3Phase 3Wire				6761899	1200-600/5	2.022	NA	Director/D	
B.6181	North	NAWANSHAHR	11KV	DS DIVN. NAWANSHAHR	DS S/U S/D NAWANSHAHR	C653FL15	11KV MEHONDIPUR	AMR	OK	31.03.2023	AP 3Phase 3Wire				6251365	1200-600/5	2.025	NA	Director/D	
B.6182	North	NAWANSHAHR	11KV	DS DIVN. NAWANSHAHR	DS S/U S/D NAWANSHAHR	C653FL04	11KV LANGROYA	AMR	OK	31.03.2023	AP 3Phase 3Wire				9140687	1200-600/5	2.931	NA	Director/D	
B.6183	North	NAWANSHAHR	11KV	DS DIVN. NAWANSHAHR	DS S/U S/D NAWANSHAHR	C653FL16	11KV SIMBLI	AMR	OK	31.03.2023	AP 3Phase 3Wire				8232327	1200-600/5	4.293	NA	Director/D	
B.6184	North	NAWANSHAHR	11KV	DS DIVN. NAWANSHAHR	DS S/U S/D NAWANSHAHR	C653FL05	11KV KARYAM	AMR	OK	31.03.2023	AP 3Phase 3Wire				8223246	1200-600/5	5.404	NA	Director/D	
B.6185	North	NAWANSHAHR	11KV	DS DIVN. NAWANSHAHR	DS S/U S/D NAWANSHAHR	C653FL01	11KV BARNALA	AMR	OK	31.03.2023	Category 5-UPS				8223530	1200-600/5	12.136	NA	Director/D	
B.6186	North	NAWANSHAHR	11KV	DS DIVN. NAWANSHAHR	DS S/U S/D NAWANSHAHR	0672FL08	11KV BHEEN (Urban)	AMR	OK	31.03.2023	Category 1				16199229	600/577/1-1	1.207	NA	Director/D	
B.6187	North	NAWANSHAHR	11KV	DS DIVN. NAWANSHAHR	DS S/U S/D NAWANSHAHR	0672FL05	11 KV MAMALON	AMR	OK	31.03.2023	AP 3Phase 3Wire				16194359	600/577/1-1	1.977	NA	Director/D	
B.6188	North	NAWANSHAHR	11KV	DS DIVN. NAWANSHAHR	DS S/U S/D NAWANSHAHR	0672FL06	11KV MUSAPUR	AMR	OK	31.03.2023	AP 3Phase 3Wire				16194379	600/577/1-1	1.987	NA	Director/D	
B.6189	North	NAWANSHAHR	11KV	DS DIVN. NAWANSHAHR	DS S/U S/D NAWANSHAHR	0672FL04	11KV MUBARKPUR	NON AMR	OK	31.03.2023	AP 3Phase 3Wire				44891	600/577/1-1	2.535	NA	Director/D	
B.6190	North	NAWANSHAHR	11KV	DS DIVN. NAWANSHAHR	DS S/U S/D NAWANSHAHR	0672FL03	11KV KOT PATTI	AMR	OK	31.03.2023	AP 3Phase 3Wire				44890	600/577/1-1	2.851	NA	Director/D	
B.6191	North	NAWANSHAHR	11KV	DS DIVN. NAWANSHAHR	DS S/U S/D NAWANSHAHR	0672FL07	11 KV LABOWAL	AMR	OK	31.03.2023	Category 5-UPS				15194841	600/577/1-1	4.670	NA	Director/D	
B.6192	North	NAWANSHAHR	11KV	DS DIVN. NAWANSHAHR	DS S/U S/D NAWANSHAHR	0672FL09	11KV GUJARWAR	AMR	OK	31.03.2023	Category 5-UPS				16189224	600/577/1-1	6.753	NA	Director/D	
B.6193	North	NAWANSHAHR	11KV	DS DIVN. NAWANSHAHR	DS S/U S/D NAWANSHAHR	0672FL02	11KV GHATARON	NON AMR	OK	31.03.2023	Category 5-UPS				15194840	600/577/1-1	10.582	NA	Director/D	
B.6194	South	BARNALA	11KV	DS CITY DIVN. BARNALA	DS CITY S/D BARNALA	0234FL09	Sub Station Barnala	AMR	OK	31.03.2023	Substation Transformer				99	1200/577/1-1	0.025	NA	Director/D	
B.6195	South	BARNALA	11KV	DS CITY DIVN. BARNALA	DS CITY S/D BARNALA	0234FL20	Colony Feeder	AMR	OK	31.03.2023	Category 1				579599	1200/577/1-1	0.104	NA	Director/D	
B.6196	South	BARNALA	11KV	DS CITY DIVN. BARNALA	DS CITY S/D BARNALA	0234FL05	RADAR	AMR	OK	31.03.2023	Category 2				10282823	1200/577/1-1	0.165	NA	Director/D	
B.6197	South	BARNALA	11KV	DS CITY DIVN. BARNALA	DS CITY S/D BARNALA	0234FL14	Hogwaji	AMR	OK	31.03.2023	Category 4				2068514	1200/577/1-1	0.692	NA	Director/D	
B.6198	South	BARNALA	11KV	DS CITY DIVN. BARNALA	DS CITY S/D BARNALA	0234FL17	Phanwahi Bazar	AMR	OK	31.03.2023	Category 1				579602	1200/577/1-1	6.357	NA	Director/D	
B.6199	South	BARNALA	11KV	DS CITY DIVN. BARNALA	DS CITY S/D BARNALA	0234FL19	Handiaya Bazar	AMR	OK	31.03.2023	Category 1				10288360	900-450/577/1-1	8.367	NA	Director/D	
B.6200	South	BARNALA	11KV	DS CITY DIVN. BARNALA	DS CITY S/D BARNALA	0234FL12	OLD BUS STAND	AMR	OK	31.03.2023	Category 1				7039582	1200/577/1-1	9.287	NA	Director/D	
B.6201	South	BARNALA	11KV	DS CITY DIVN. BARNALA	DS CITY S/D BARNALA	0234FL09	DHAUNALA ROAD	NON AMR	OK	31.03.2023	Category 1				579596	1200/577/1-1	12.233	NA	Director/D	
B.6202	South	BARNALA	11KV	DS CITY DIVN. BARNALA	DS CITY S/D BARNALA	0234FL02	11KV KC Road Feeder	NON AMR	OK	31.03.2023	Category 1				2067961	1200/577/1-1	12.579	NA	Director/D	
B.6203	South	BARNALA	11KV	DS CITY DIVN. BARNALA	DS CITY S/D BARNALA	0234FL06	SEWA ROAD	AMR	OK	31.03.2023	Category 1				5795931	900-450/577/1-1	16.345	NA	Director/D	
B.6204	South	BARNALA	11KV	DS CITY DIVN. BARNALA	DS CITY S/D BARNALA	0234FL01	SADAR BAZAAR	AMR	OK	31.03.2023	Category 1				2067790	1200/577/1-1	15.270	NA	Director/D	
B.6205	South	BARNALA	11KV	DS CITY DIVN. BARNALA	DS CITY S/D BARNALA	0237FL10	RADAR	AMR	OK	31.03.2023	Category 2				2046555	900-450/577/1-1	5.653	NA	Director/D	
B.6206	South	BARNALA	11KV	DS CITY DIVN. BARNALA	DS S/D MEHAL KALAN	0239FL19	SARVESH SPINNERS	AMR	OK	31.03.2023	Category 4				5437677	1200/577/1-1	0.052	NA	Director/D	
B.6207	South	BARNALA	11KV	DS CITY DIVN. BARNALA	DS S/D MEHAL KALAN	0239FL99	Sub Station Mehal Kalan	AMR	OK	31.03.2023	Substation Transformer				99	1200/577/1-1	0.097	NA	Director/D	
B.6208	South	BARNALA	11KV	DS CITY DIVN. BARNALA	DS S/D MEHAL KALAN	0239FL07	KALALA	AMR	OK	31.03.2023	AP 3Phase 3Wire				8222986	1200/577/1-1	3.149	NA	Director/D	
B.6209	South	BARNALA	11KV	DS CITY DIVN. BARNALA	DS S/D MEHAL KALAN	0239FL17	KOTHE BARDUNDI	NON AMR	OK	31.03.2023	AP 3Phase 3Wire				8222988	1200/577/1-1	3.162	NA	Director/D	
B.6210	South	BARNALA	11KV	DS CITY DIVN. BARNALA	DS S/D MEHAL KALAN	0239FL29	VISHAV KARMA	AMR	OK	31.03.2023	AP 3Phase 3Wire				8222664	1200/577/1-1	3.777	NA	Director/D	
B.6211	South	BARNALA	11KV	DS CITY DIVN. BARNALA	DS S/D MEHAL KALAN	0239FL01	INDUSTRIAL	AMR	OK	31.03.2023	Category 2				7030186	1200/577/1-1	3.777	NA	Director/D	
B.6212	South	BARNALA	11KV	DS CITY DIVN. BARNALA	DS S/D MEHAL KALAN	0239FL11	PANDORI	AMR	OK	31.03.2023	AP 3Phase 3Wire				6745310	1200/577/1-1	4.002	NA	Director/D	
B.6213	South	BARNALA	11KV	DS CITY DIVN. BARNALA	DS S/D MEHAL KALAN	0239FL13	MEHAL KALAN RURAL	AMR	OK	31.03.2023	AP 3Phase 3Wire				9140861	1200/577/1-1	4.466	NA	Director/D	
B.6214	South	BARNALA	11KV	DS CITY DIVN. BARNALA	DS S/D MEHAL KALAN	0239FL14	SAHOUR	AMR	OK	31.03.2023	AP 3Phase 3Wire				8223852	1200/577/1-1	4.600	NA	Director/D	
B.6215	South	BARNALA	11KV	DS CITY DIVN. BARNALA	DS S/D MEHAL KALAN	0239FL18	RASAR	AMR	OK	31.03.2023	AP 3Phase 3Wire				6679867	1200/577/1-1	4.750	NA	Director/D	
B.6216	South	BARNALA	11KV	DS CITY DIVN. BARNALA	DS S/D MEHAL KALAN	0239FL12	CHANNANWAL	AMR	OK	31.03.2023	AP 3Phase 3Wire				7336568	1200/577/1-1	4.830	NA	Director/D	
B.6217	South	BARNALA	11KV	DS CITY DIVN. BARNALA	DS S/D MEHAL KALAN	0239FL05	SEHARA	AMR	OK	31.03.2023	AP 3Phase 3Wire				7042909	1200/577/1-1	5.030	NA	Director/D	
B.6218	South	BARNALA	11KV	DS CITY DIVN. BARNALA	DS S/D MEHAL KALAN	0239FL04	CHHNNIWAL	AMR	OK	31.03.2023	AP 3Phase 3Wire				6740802	1200/577/1-1	5.189	NA	Director/D	
B.6219	South	BARNALA	11KV	DS CITY DIVN. BARNALA	DS S/D MEHAL KALAN	0239FL15	WADIKI KHURD	AMR	OK	31.03.2023	AP 3Phase 3Wire				8222965	1200/577/1-1	5.452	NA	Director/D	
B.6220	South	BARNALA	11KV	DS CITY DIVN. BARNALA	DS S/D MEHAL KALAN	0239FL16	MOON	AMR	OK	31.03.2023	AP 3Phase 3Wire				8223851	1200/577/1-1	5.577	NA	Director/D	
B.6221	South	BARNALA	11KV	DS CITY DIVN. BARNALA	DS S/D MEHAL KALAN	0239FL08	DHANER	AMR	OK	31.03.2023	AP 3Phase 3Wire				8222989	1200/577/1-1	5.907	NA	Director/D	
B.6222	South	BARNALA	11KV	DS CITY DIVN. BARNALA	DS S/D MEHAL KALAN	0239FL02	MEHAL KALAN CITY	NON AMR	OK	31.03.2023	Category 5-UPS				12479775	1200/577/1-1	8.379	NA	Director/D	
B.6223	South	BARNALA	11KV	DS CITY DIVN. BARNALA	DS S/D MEHAL KALAN	0239FL30	MEHAL KHURAD UPS	AMR	OK	31.03.2023	Category 5-UPS				11117024	1200/577/1-1	9.260	NA	Director/D	
B.6224	South	BARNALA	11KV	DS CITY DIVN. BARNALA	DS S/D MEHAL KALAN	0239FL06	Sehija UPS	AMR	OK	31.03.2023	Category 5-UPS				2066550	1200/577/1-1	13.710	NA	Director/D	
B.6225	South	BARNALA	11KV	DS CITY DIVN. BARNALA	DS S/D MEHAL KALAN	0239FL03	WADIKI 4th HRS	NON AMR	OK	31.03.2023	Category 5-UPS				11116848	1200/577/1-1	15.037	NA	Director/D	
B.6226	South	BARNALA	11KV	DS CITY DIVN. BARNALA	DS S/D MEHAL KALAN	7013FL59	Sub Station Channan wal	NON AMR	OK	31.03.2023	Substation Transformer				99	900-450/577/1-1	1.010	NA	Director/D	
B.6227	South	BARNALA	11KV	DS CITY DIVN. BARNALA	DS S/D MEHAL KALAN	7013FL17	KALALA	NON AMR	OK	31.03.2023	Category 1				4054	900-450/577/1-1	1.021	NA	Director/D	
B.6228	South	BARNALA	11KV	DS CITY DIVN. BARNALA	DS S/D MEHAL KALAN	7013FL08	TIWANA	AMR	OK	31.03.2023	AP 3Phase 3Wire				34433	900-450/577/1-1	1.422	NA	Director/D	
B.6229	South	BARNALA	11KV	DS CITY DIVN. BARNALA	DS S/D MEHAL KALAN	7013FL18	SIDHU	NON AMR	OK	31.03.2023	AP 3Phase 3Wire				4428	900-450/577/1-1	1.602	NA	Director/D	
B.6230	South	BARNALA	11KV	DS CITY DIVN. BARNALA	DS S/D MEHAL KALAN	713FL03	SIDHU JATANA	NON AMR	OK	31.03.2023	AP 3Phase 3Wire				13190518	900-450/577/1-1	1.708	NA	Director/D	
B.6231	South	BARNALA	11KV	DS CITY DIVN. BARNALA	DS S/D MEHAL KALAN	7013FL11	NON AMR	OK	31.03.2023	AP 3Phase 3Wire				30194	900-450/577/1-1	1.962	NA	Director/D		
B.6232	South	BARNALA	11KV	DS CITY DIVN. BARNALA	DS S/D MEHAL KALAN	7013FL15	BAKHAT GARRH ROAD	NON AMR	OK	31.03.2023	AP 3Phase 3Wire				15193834	900-450/577/1-1	2.001	NA	Director/D	
B.6233	South	BARNALA	11KV	DS CITY DIVN. BARNALA	DS S/D MEHAL KALAN	713FL01	BULANDSAR	NON AMR	OK	31.03.2023	AP 3Phase 3Wire				13190502	900-450/577/1-1	2.058	NA	Director/D	
B.6234	South	BARNALA	11KV	DS CITY DIVN. BARNALA	DS S/D MEHAL KALAN	7013FL14	BHAI ANA SAHIB	NON AMR	OK	31.03.2023	AP 3Phase 3Wire				15193707	900-450/577/1-1	2.375	NA	Director/D	
B.6235	South	BARNALA	11KV	DS CITY DIVN. BARNALA	DS S/D MEHAL KALAN	7013FL07	GILL	NON AMR	OK	31.03.2023	AP 3Phase 3Wire				36936	900-450/577/1-1	2.389	NA	Director/D	
B.6236	South	BARNALA	11KV	DS CITY DIVN. BARNALA	DS S/D MEHAL KALAN	713FL08	SEHARA	NON AMR	OK	31.03.2023	AP 3Phase 3Wire				13190504	900-450/577/1-1	2.476	NA	Director/D	
B.6237	South	BARNALA	11KV	DS CITY DIVN. BARNALA	DS S/D MEHAL KALAN	T-13FL06	CHAKK ROHI	NON AMR	OK	31.03.2023	AP 3Phase 3Wire				36921	900-450/577/1-1	2.616	NA	Director/D	
B.6238	South	BARNALA	11KV	DS CITY DIVN. BARNALA	DS S/D MEHAL KALAN	7013FL09	DHALIWAL	NON AMR	OK	31.03.2023	AP 3Phase 3Wire				36951	900-450/577/1-1	2.735	NA	Director/D	
B.6239	South	BARNALA	11KV	DS CITY DIVN. BARNALA	DS S/D MEHAL KALAN	T-13FL04	Channawal UPS	NON AMR	OK	31.03.2023	Category 5-UPS				13190538	900-450/577/1-1	3.856	NA	Director/D	
B.6240	South	BARNALA	11KV	DS CITY DIVN. BARNALA	DS S/D MEHAL KALAN	7013FL16	RAISAR UPS	NON AMR	OK	31.03.2023	Category 5-UPS				16194360	900-450/577/1-1	6.640	NA	Director/D	
B.6241	South	BARNALA	11KV	DS CITY DIVN. BARNALA	DS S/D MEHAL KALAN	T-13FL05	Moom UPS	AMR	OK	31.03.2023	Category 5-UPS				24291	900-450/577/1-1	8.334	NA		

S.No	Zone	Circle	Voltage Level (kVA)	Division (kVA)	Sub-Division (kVA)	Feeder ID	Feeder Name	Feeder Metering Status (Metred/unmetred/AMR/AMI)	Status of Meter (Functional/Non-Functional)	Metering Date (Date of last actual meter reading/communication)	Feeder Type (Agr/Industrial/Mixed)	Status of Communication			Period from 01.04.2021 to 31.03.2022				Sales	Remarks (Source of data)
												% data received through automatically if feeder AMR/AMI	Number of hours when meter was unable to communicate in period	Total Number of hours in the period	Meter S.No	CT/PT ratio	Import (kU)	Export (kU)		
B.6275	South	BARNALA	11KV	DS CITY DIVN. BARNALA	DS S/D NO-1 DHANAULA	0240FL29	SATE WALA	AMR	OK	31.03.2023	AP 3Phase 3Wire				4362	Not installed	2.566	NA	Director/D	
B.6276	South	BARNALA	11KV	DS CITY DIVN. BARNALA	DS S/D NO-1 DHANAULA	0240FL06	PANDHER	NON AMR	OK	31.03.2023	AP 3Phase 3Wire				7336580	1200/577/1-1	2.621	NA	Director/D	
B.6277	South	BARNALA	11KV	DS CITY DIVN. BARNALA	DS S/D NO-1 DHANAULA	0240FL15	KAPURU	NON AMR	OK	31.03.2023	AP 3Phase 3Wire				3199	Not installed	2.685	NA	Director/D	
B.6278	South	BARNALA	11KV	DS CITY DIVN. BARNALA	DS S/D NO-1 DHANAULA	0240FL13	BARA BANODAS	AMR	OK	31.03.2023	AP 3Phase 3Wire				236260	1200/577/1-1	2.748	NA	Director/D	
B.6279	South	BARNALA	11KV	DS CITY DIVN. BARNALA	DS S/D NO-1 DHANAULA	0240FL35	KARBAN WALA	AMR	OK	31.03.2023	AP 3Phase 3Wire				4587	1200/577/1-1	2.828	NA	Director/D	
B.6280	South	BARNALA	11KV	DS CITY DIVN. BARNALA	DS S/D NO-1 DHANAULA	0240FL09	ASPAL KALAN CAT-1	AMR	OK	31.03.2023	Category 1				10281285	1200/577/1-1	4.842	NA	Director/D	
B.6281	South	BARNALA	11KV	DS CITY DIVN. BARNALA	DS S/D NO-1 DHANAULA	0240FL19	U.P.S-2	AMR	OK	31.03.2023	Category 5-UPS				16194369	Not installed	7.340	NA	Director/D	
B.6282	South	BARNALA	11KV	DS CITY DIVN. BARNALA	DS S/D NO-1 DHANAULA	0240FL34	U.P.S. KALEKE	AMR	OK	31.03.2023	Category 5-UPS				4937	900-450/577/1-1	8.636	NA	Director/D	
B.6283	South	BARNALA	11KV	DS CITY DIVN. BARNALA	DS S/D NO-1 DHANAULA	0240FL02	U.P.S-1	AMR	OK	31.03.2023	Category 5-UPS				4740	1200/577/1-1	10.795	NA	Director/D	
B.6284	South	BARNALA	11KV	DS CITY DIVN. BARNALA	DS S/D NO-1 DHANAULA	0235FL08	BHANGU	AMR	OK	31.03.2023	AP 3Phase 3Wire				13190495	1200/577/1-1	0.000	NA	Director/D	
B.6285	South	BARNALA	11KV	DS CITY DIVN. BARNALA	DS S/D NO-1 DHANAULA	0235FL99	Sub Station Dhanoula	AMR	OK	31.03.2023	Substation Transformer				9141141	1200/577/1-1	0.106	NA	Director/D	
B.6286	South	BARNALA	11KV	DS CITY DIVN. BARNALA	DS S/D NO-1 DHANAULA	0235FL02	BHAINI	AMR	OK	31.03.2023	AP 3Phase 3Wire				2994124	1200/577/1-1	3.576	NA	Director/D	
B.6287	South	BARNALA	11KV	DS CITY DIVN. BARNALA	DS S/D NO-1 DHANAULA	0235FL15	BADESHA	AMR	OK	31.03.2023	AP 3Phase 3Wire				15192324	1200/577/1-1	3.721	NA	Director/D	
B.6288	South	BARNALA	11KV	DS CITY DIVN. BARNALA	DS S/D NO-1 DHANAULA	0235FL11	UPS-1	AMR	OK	31.03.2023	Category 5-UPS				9141142	1200/577/1-1	4.045	NA	Director/D	
B.6289	South	BARNALA	11KV	DS CITY DIVN. BARNALA	DS S/D NO-1 DHANAULA	0235FL12	KALEKE NEW/1 OLD	AMR	OK	31.03.2023	AP 3Phase 3Wire				9534980	1200/577/1-1	5.625	NA	Director/D	
B.6290	South	BARNALA	11KV	DS CITY DIVN. BARNALA	DS S/D NO-1 DHANAULA	0235FL24	UPS-II	AMR	OK	31.03.2023	Category 5-UPS				13190495	1200/577/1-1	0.066	NA	Director/D	
B.6291	South	BARNALA	11KV	DS CITY DIVN. BARNALA	DS S/D NO-1 DHANAULA	0235FL07	URBAN DHAUNALA CITY	AMR	OK	31.03.2023	Category 1				9141142	1200/577/1-1	13.740	NA	Director/D	
B.6292	South	BARNALA	11KV	DS CITY DIVN. BARNALA	DS S/D NO-1 DHANAULA	0235FL10	URBAN RAIGARH ROAD	AMR	OK	31.03.2023	Category 1				12093563	1200/577/1-1	14.260	NA	Director/D	
B.6293	South	BARNALA	11KV	DS CITY DIVN. BARNALA	DS S/D NO-1 DHANAULA	0244FL03	FATHEGARH CHANNA	AMR	OK	31.03.2023	AP 3Phase 3Wire				2066823	900-450/577/1-1	3.658	NA	Director/D	
B.6294	South	BARNALA	11KV	DS CITY DIVN. BARNALA	DS S/D NO-1 DHANAULA	0244FL09	BHAINI JASSA	AMR	OK	31.03.2023	AP 3Phase 3Wire				8227287	900-450/577/1-1	4.165	NA	Director/D	
B.6295	South	BARNALA	11KV	DS CITY DIVN. BARNALA	DS S/D NO-2 DHANAULA	K320FL10	Rubba AP	AMR	OK	31.03.2023	AP 3Phase 3Wire				4352	Not installed	1.552	NA	Director/D	
B.6296	South	BARNALA	11KV	DS CITY DIVN. BARNALA	DS S/D NO-2 DHANAULA	X203FL99	Sub Station Badbar	NON AMR	OK	31.03.2023	Substation Transformer				99	1200/577/1-1	0.043	NA	Director/D	
B.6297	South	BARNALA	11KV	DS CITY DIVN. BARNALA	DS S/D NO-2 DHANAULA	X203FL19	Baba Muqand Das	AMR	OK	31.03.2023	AP 3Phase 3Wire				15193815	900-450/577/1-1	1.535	NA	Director/D	
B.6298	South	BARNALA	11KV	DS CITY DIVN. BARNALA	DS S/D NO-2 DHANAULA	X203FL03	Sati Mai	AMR	OK	31.03.2023	AP 3Phase 3Wire				7349820	1200/577/1-1	1.777	NA	Director/D	
B.6299	South	BARNALA	11KV	DS CITY DIVN. BARNALA	DS S/D NO-2 DHANAULA	X203FL02	Baba Mamna	AMR	OK	31.03.2023	AP 3Phase 3Wire				7336706	1200/577/1-1	1.903	NA	Director/D	
B.6300	South	BARNALA	11KV	DS CITY DIVN. BARNALA	DS S/D NO-2 DHANAULA	X203FL15	Loha Khara	NON AMR	OK	31.03.2023	AP 3Phase 3Wire				11114495	900-450/577/1-1	2.241	NA	Director/D	
B.6301	South	BARNALA	11KV	DS CITY DIVN. BARNALA	DS S/D NO-2 DHANAULA	X203FL30	Bhai Bholu	NON AMR	OK	31.03.2023	AP 3Phase 3Wire				4308	900-450/577/1-1	2.269	NA	Director/D	
B.6302	South	BARNALA	11KV	DS CITY DIVN. BARNALA	DS S/D NO-2 DHANAULA	X203FL09	Baba Bulle Shah	AMR	OK	31.03.2023	AP 3Phase 3Wire				11114495	1200/577/1-1	2.390	NA	Director/D	
B.6303	South	BARNALA	11KV	DS CITY DIVN. BARNALA	DS S/D NO-2 DHANAULA	X203FL01	Duggan	NON AMR	OK	31.03.2023	AP 3Phase 3Wire				7336731	1200/577/1-1	2.396	NA	Director/D	
B.6304	South	BARNALA	11KV	DS CITY DIVN. BARNALA	DS S/D NO-2 DHANAULA	X203FL10	Mastuana Sahib	AMR	OK	31.03.2023	AP 3Phase 3Wire				9153609	1200/577/1-1	2.400	NA	Director/D	
B.6305	South	BARNALA	11KV	DS CITY DIVN. BARNALA	DS S/D NO-2 DHANAULA	X203FL07	Baba Karam Singh	NON AMR	OK	31.03.2023	AP 3Phase 3Wire				1114537	900-450/577/1-1	2.427	NA	Director/D	
B.6306	South	BARNALA	11KV	DS CITY DIVN. BARNALA	DS S/D NO-2 DHANAULA	X203FL05	Bhai Mik	AMR	OK	31.03.2023	Category 4				9153609	900-450/577/1-1	4.244	NA	Director/D	
B.6307	South	BARNALA	11KV	DS CITY DIVN. BARNALA	DS S/D NO-2 DHANAULA	X203FL04	Badbar Cat-I	NON AMR	OK	31.03.2023	Category 1				7336705	1200/577/1-1	6.941	NA	Director/D	
B.6308	South	BARNALA	11KV	DS CITY DIVN. BARNALA	DS S/D NO-2 DHANAULA	X203FL06	UPS Bhure Kube	AMR	OK	31.03.2023	Category 5-UPS				15193789	900-450/577/1-1	8.387	NA	Director/D	
B.6309	South	BARNALA	11KV	DS CITY DIVN. BARNALA	DS S/D NO-2 DHANAULA	0235FL06	Badbar	AMR	OK	31.03.2023	AP 3Phase 3Wire				13190591	1200/577/1-1	3.819	NA	Director/D	
B.6310	South	BARNALA	11KV	DS CITY DIVN. BARNALA	DS S/D NO-2 DHANAULA	0235FL03	Harigarh	NON AMR	OK	31.03.2023	AP 3Phase 3Wire				9140899	1200/577/1-1	4.169	NA	Director/D	
B.6311	South	BARNALA	11KV	DS CITY DIVN. BARNALA	DS S/D NO-2 DHANAULA	0235FL05	Aur Singh Wala	AMR	OK	31.03.2023	AP 3Phase 3Wire				13190596	1200/577/1-1	5.326	NA	Director/D	
B.6312	South	BARNALA	11KV	DS CITY DIVN. BARNALA	DS S/D NO-2 DHANAULA	0235FL09	Bhuthian	AMR	OK	31.03.2023	AP 3Phase 3Wire				8227282	1200/577/1-1	5.783	NA	Director/D	
B.6313	South	BARNALA	11KV	DS CITY DIVN. BARNALA	DS S/D NO-2 DHANAULA	0235FL01	UPS-2	NON AMR	OK	31.03.2023	Category 5-UPS				9154354	1200/577/1-1	10.111	NA	Director/D	
B.6314	South	BARNALA	11KV	DS CITY DIVN. BARNALA	DS S/D NO-2 DHANAULA	X236FL99	Sub Station Kattu	NON AMR	OK	31.03.2023	Substation Transformer				822859	900-450/577/1-1	0.024	NA	Director/D	
B.6315	South	BARNALA	11KV	DS CITY DIVN. BARNALA	DS S/D NO-2 DHANAULA	0236FL09	Bhaini	NON AMR	OK	31.03.2023	AP 3Phase 3Wire				4731	900-450/577/1-1	1.168	NA	Director/D	
B.6316	South	BARNALA	11KV	DS CITY DIVN. BARNALA	DS S/D NO-2 DHANAULA	0236FL03	Uppal	NON AMR	OK	31.03.2023	AP 3Phase 3Wire				1114502	900-450/577/1-1	1.223	NA	Director/D	
B.6317	South	BARNALA	11KV	DS CITY DIVN. BARNALA	DS S/D NO-2 DHANAULA	X236FL10	Sub Station	AMR	OK	31.03.2023	AP 3Phase 3Wire				4409	900-450/577/1-1	1.889	NA	Director/D	
B.6318	South	BARNALA	11KV	DS CITY DIVN. BARNALA	DS S/D NO-2 DHANAULA	0236FL02	Jhal Wala	AMR	OK	31.03.2023	AP 3Phase 3Wire				8223859	900-450/577/1-1	1.998	NA	Director/D	
B.6319	South	BARNALA	11KV	DS CITY DIVN. BARNALA	DS S/D NO-2 DHANAULA	0236FL11	Bhai Mulla	AMR	OK	31.03.2023	AP 3Phase 3Wire				9140939	900-450/577/1-1	2.021	NA	Director/D	
B.6320	South	BARNALA	11KV	DS CITY DIVN. BARNALA	DS S/D NO-2 DHANAULA	0236FL20	Bhathe Wala	AMR	OK	31.03.2023	AP 3Phase 3Wire				4195	900-450/577/1-1	2.249	NA	Director/D	
B.6321	South	BARNALA	11KV	DS CITY DIVN. BARNALA	DS S/D NO-2 DHANAULA	0236FL06	Kattu Main	NON AMR	OK	31.03.2023	AP 3Phase 3Wire				9140937	900-450/577/1-1	2.254	NA	Director/D	
B.6322	South	BARNALA	11KV	DS CITY DIVN. BARNALA	DS S/D NO-2 DHANAULA	0236FL21	Nara Singh	AMR	OK	31.03.2023	AP 3Phase 3Wire				4756	900-450/577/1-1	3.328	NA	Director/D	
B.6323	South	BARNALA	11KV	DS CITY DIVN. BARNALA	DS S/D NO-2 DHANAULA	0236FL19	Kuswan Road	AMR	OK	31.03.2023	AP 3Phase 3Wire				11114489	900-450/577/1-1	3.230	NA	Director/D	
B.6324	South	BARNALA	11KV	DS CITY DIVN. BARNALA	DS S/D NO-2 DHANAULA	0236FL05	24 Hours-Kattu UPS	NON AMR	OK	31.03.2023	Category 5-UPS				2067971	900-450/577/1-1	9.797	NA	Director/D	
B.6325	South	BARNALA	11KV	DS CITY DIVN. BARNALA	DS S/D SANGHERA	0288FL11	GURMA ROAD	NON AMR	OK	31.03.2023	AP 3Phase 3Wire				4326	1200-600/5	1.146	NA	Director/D	
B.6326	South	BARNALA	11KV	DS CITY DIVN. BARNALA	DS S/D SANGHERA	0288FL07	THULUWAL	NON AMR	OK	31.03.2023	AP 3Phase 3Wire				15193908	1200-600/5	1.993	NA	Director/D	
B.6327	South	BARNALA	11KV	DS CITY DIVN. BARNALA	DS S/D SANGHERA	0288FL08	NANGU UPS	AMR	OK	31.03.2023	Category 5-UPS				1514648	1200-600/5	3.598	NA	Director/D	
B.6328	South	BARNALA	11KV	DS CITY DIVN. BARNALA	DS S/D SANGHERA	0234FL16	SANGHERA AP	AMR	OK	31.03.2023	Category 1				9154271	900-450/577/1-1	0.061	NA	Director/D	
B.6329	South	BARNALA	11KV	DS CITY DIVN. BARNALA	DS S/D SANGHERA	0234FL13	Sanghera Road	AMR	OK	31.03.2023	Category 1				9154271	1200/577/1-1	11.327	NA	Director/D	
B.6330	South	BARNALA	11KV	DS CITY DIVN. BARNALA	DS S/D SANGHERA	0234FL10	JANDAWALA ROAD	AMR	OK	31.03.2023	Category 1				10282830	900-450/577/1-1	19.629	NA	Director/D	
B.6331	South	BARNALA	11KV	DS CITY DIVN. BARNALA	DS S/D SANGHERA	0247FL15	KOTHE NIHALI SINGH WALA BR.	AMR	OK	31.03.2023	AP 3Phase 3Wire				8223853	1200/577/1-1	0.000	NA	Director/D	
B.6332	South	BARNALA	11KV	DS CITY DIVN. BARNALA	DS S/D SANGHERA	0247FL17	NANGA-2 BR.	AMR	OK	31.03.2023	AP 3Phase 3Wire				12093529	1200/577/1-1	0.000	NA	Director/D	
B.6333	South	BARNALA	11KV	DS CITY DIVN. BARNALA	DS S/D SANGHERA	0247FL99	Sub Station Karamgarh	AMR	OK	31.03.2023	Substation Transformer				9140937	1200/577/1-1	0.006	NA	Director/D	
B.6334	South	BARNALA	11KV	DS CITY DIVN. BARNALA	DS S/D SANGHERA	0247FL19	KOTHE GAEWAL	AMR	OK	31.03.2023	AP 3Phase 3Wire				8223854	1200/577/1-1	0.267	NA	Director/D	
B.6335	South	BARNALA	11KV	DS CITY DIVN. BARNALA	DS S/D SANGHERA	0247FL09	Bhathe Wala	AMR	OK	31.03.2023	AP 3Phase 3Wire				11116738	1200/577/1-1	1.989	NA	Director/D	
B.6336	South	BARNALA	11KV	DS CITY DIVN. BARNALA	DS S/D SANGHERA	0247FL01	KARAMGARH RURAL	AMR	OK	31.03.2023	AP 3Phase 3Wire				8223855	1200/577/1-1	2.158	NA	Director/D	
B.6337	South	BARNALA	11KV	DS CITY DIVN. BARNALA	DS S/D SANGHERA	0247FL04	Kheri Kothe (KR)	NON AMR	OK	31.03.2023	AP 3Phase 3Wire				9141145	1200/577/1-1	2.669	NA	Director/D	
B.6338	South	BARNALA	11KV	DS CITY DIVN. BARNALA	DS S/D SANGHERA	0247FL12	M.C. ROAD	AMR	OK	31.03.2023	AP 3Phase 3Wire				15194846	1200/577/1-1	3.70			

S.No	Zone	Circle	Voltage Level (kVA)	Division (kVA)	Sub-Division (kVA)	Feeder ID	Feeder Name	Feeder Metering Status (Metered/unmetered/AMR/AMI)	Status of Meter (Functional/Non-Functional)	Metering Date (Date of last actual meter reading/communication)	Feeder Type (Agr/Industrial/Mixed)	Status of Communication			Period from 01.04.2021 to 31.03.2022				Sales	Remarks (Source of data)
												% data received through automatically if feeder AMR/AMI	Number of hours when meter was unable to communicate in week	Total Number of hours in the period	Meter S.No	CT/PT ratio	Import (kWh)	Export (kWh)		
B.6372	South	BARNALA	11KV	DS CITY DIVN. BARNALA	DS S/D THULIWAL	T012F12	TLA SAHIB	AMR	OK	31.03.2023	AP 3Phase 3Wire				37025	900-450/577/1-1-1	1.645	NA	Director/D	
B.6373	South	BARNALA	11KV	DS CITY DIVN. BARNALA	DS S/D THULIWAL	T012F11	BHULANA SAHIB	AMR	OK	31.03.2023	AP 3Phase 3Wire				37028	900-450/577/1-1-1	1.650	NA	Director/D	
B.6374	South	BARNALA	11KV	DS CITY DIVN. BARNALA	DS S/D THULIWAL	T12FL04	JORPWA	NON AMR	OK	31.03.2023	AP 3Phase 3Wire				12093483	900-450/577/1-1-1	1.866	NA	Director/D	
B.6375	South	BARNALA	11KV	DS CITY DIVN. BARNALA	DS S/D THULIWAL	T12FL02	Dousha Singh wala	NON AMR	OK	31.03.2023	Category 1				12093755	900-450/577/1-1-1	1.993	NA	Director/D	
B.6376	South	BARNALA	11KV	DS CITY DIVN. BARNALA	DS S/D THULIWAL	T012FL10	Mithewal	AMR	OK	31.03.2023	Category 5-UPS				37106	900-450/577/1-1-1	2.025	NA	Director/D	
B.6377	South	BARNALA	11KV	DS CITY DIVN. BARNALA	DS S/D THULIWAL	T012FL09	KALA. MALA SAHIB	AMR	OK	31.03.2023	AP 3Phase 3Wire				37046	900-450/577/1-1-1	2.110	NA	Director/D	
B.6378	South	BARNALA	11KV	DS CITY DIVN. BARNALA	DS S/D THULIWAL	T12FL05	kalinjar	NON AMR	OK	31.03.2023	AP 3Phase 3Wire				24235	900-450/577/1-1-1	2.181	NA	Director/D	
B.6379	South	BARNALA	11KV	DS CITY DIVN. BARNALA	DS S/D THULIWAL	T12FL03	DERA QUTIA	AMR	OK	31.03.2023	AP 3Phase 3Wire				12093581	900-450/577/1-1-1	2.217	NA	Director/D	
B.6380	South	BARNALA	11KV	DS CITY DIVN. BARNALA	DS S/D THULIWAL	T12FL26	BABA SAHEED	AMR	OK	31.03.2023	AP 3Phase 3Wire				3393	900-450/577/1-1-1	2.260	NA	Director/D	
B.6381	South	BARNALA	11KV	DS CITY DIVN. BARNALA	DS S/D THULIWAL	T012FH13	Bagpla Road AP	AMR	OK	31.03.2023	AP 3Phase 3Wire				22222	900-450/577/1-1-1	2.452	NA	Director/D	
B.6382	South	BARNALA	11KV	DS CITY DIVN. BARNALA	DS S/D THULIWAL	T012FL12	Chappa UPS	NON AMR	OK	31.03.2023	Category 5-UPS				11111	900-450/577/1-1-1	3.093	NA	Director/D	
B.6383	South	BARNALA	11KV	DS CITY DIVN. BARNALA	DS S/D THULIWAL	0TB8FL15	KOTHE NAND KE	AMR	OK	31.03.2023	AP 3Phase 3Wire				5426	1200-600/5	2.228	NA	Director/D	
B.6384	South	BARNALA	11KV	DS CITY DIVN. BARNALA	DS S/D THULIWAL	0066FL04	CHAPPA	NON AMR	OK	31.03.2023	AP 3Phase 3Wire				8222434	1200-600/5	3.421	NA	Director/D	
B.6385	South	BARNALA	11KV	DS CITY DIVN. BARNALA	DS S/D THULIWAL	0066FL14	CHAPPA NEW	AMR	OK	31.03.2023	AP 3Phase 3Wire				23202	900-450/577/1-1-1	5.317	NA	Director/D	
B.6386	South	BARNALA	11KV	DS CITY DIVN. BARNALA	DS S/D THULIWAL	0204FL20	JANDNALA BR	Not available	OK	31.03.2023	AP 3Phase 3Wire				9181445	1200/577/1-1-1	0.000	NA	Director/D	
B.6387	South	BARNALA	11KV	DS CITY DIVN. BARNALA	DS S/D THULIWAL	0238FL21	PATILANA	AMR	OK	31.03.2023	AP 3Phase 3Wire				Not available	Not available	0.148	NA	Director/D	
B.6388	South	BARNALA	11KV	DS CITY DIVN. BARNALA	DS S/D THULIWAL	0238FL15	BABA PIR BR.	AMR	OK	31.03.2023	AP 3Phase 3Wire				8223875	1200/577/1-1-1	0.000	NA	Director/D	
B.6389	South	BARNALA	11KV	DS CITY DIVN. BARNALA	DS S/D THULIWAL	0238FL16	RORI WALA BR.	AMR	OK	31.03.2023	AP 3Phase 3Wire				8223872	1200/577/1-1-1	0.000	NA	Director/D	
B.6390	South	BARNALA	11KV	DS CITY DIVN. BARNALA	DS S/D THULIWAL	0238FL17	TIBBA BR.	AMR	OK	31.03.2023	AP 3Phase 3Wire				6697251	1200/577/1-1-1	0.000	NA	Director/D	
B.6391	South	BARNALA	11KV	DS CITY DIVN. BARNALA	DS S/D THULIWAL	0238FL18	KURAR BR.	AMR	OK	31.03.2023	AP 3Phase 3Wire				733754	1200/577/1-1-1	0.000	NA	Director/D	
B.6392	South	BARNALA	11KV	DS CITY DIVN. BARNALA	DS S/D THULIWAL	0238FL20	TW147 BR.	AMR	OK	31.03.2023	AP 3Phase 3Wire				8223874	1200/577/1-1-1	0.000	NA	Director/D	
B.6393	South	BARNALA	11KV	DS CITY DIVN. BARNALA	DS S/D THULIWAL	0238FL22	PANGRANAN BR.	AMR	OK	31.03.2023	AP 3Phase 3Wire				6761971	1200/577/1-1-1	0.000	NA	Director/D	
B.6394	South	BARNALA	11KV	DS CITY DIVN. BARNALA	DS S/D THULIWAL	0238FL23	MEHRKI BR.	AMR	OK	31.03.2023	AP 3Phase 3Wire				8223871	1200/577/1-1-1	0.000	NA	Director/D	
B.6395	South	BARNALA	11KV	DS CITY DIVN. BARNALA	DS S/D THULIWAL	0238FL24	BAPLA BR.	NON AMR	OK	31.03.2023	AP 3Phase 3Wire				2047180	1200/577/1-1-1	0.000	NA	Director/D	
B.6396	South	BARNALA	11KV	DS CITY DIVN. BARNALA	DS S/D THULIWAL	0238FL25	KHYALI ROAD BR.	AMR	OK	31.03.2023	AP 3Phase 3Wire				15192350	1200/577/1-1-1	0.000	NA	Director/D	
B.6397	South	BARNALA	11KV	DS CITY DIVN. BARNALA	DS S/D THULIWAL	0238FL09	Sub Station Thulwal	AMR	OK	31.03.2023	Substation Transformer				6697251	1200/577/1-1-1	0.074	NA	Director/D	
B.6398	South	BARNALA	11KV	DS CITY DIVN. BARNALA	DS S/D THULIWAL	0238FL08	MITHWAL	NON AMR	OK	31.03.2023	AP 3Phase 3Wire				2047180	1200/577/1-1-1	2.678	NA	Director/D	
B.6399	South	BARNALA	11KV	DS CITY DIVN. BARNALA	DS S/D THULIWAL	0238FL19	NANGAL ROAD	AMR	OK	31.03.2023	AP 3Phase 3Wire				15192350	1200/577/1-1-1	3.869	NA	Director/D	
B.6400	South	BARNALA	11KV	DS CITY DIVN. BARNALA	DS S/D THULIWAL	0238FL09	Drain wala/mehrki	AMR	OK	31.03.2023	AP 3Phase 3Wire				8223871	1200/577/1-1-1	3.892	NA	Director/D	
B.6401	South	BARNALA	11KV	DS CITY DIVN. BARNALA	DS S/D THULIWAL	0238FL05	Gurbaxpura	AMR	OK	31.03.2023	AP 3Phase 3Wire				8223874	1200/577/1-1-1	3.953	NA	Director/D	
B.6402	South	BARNALA	11KV	DS CITY DIVN. BARNALA	DS S/D THULIWAL	0238FL12	GURM	AMR	OK	31.03.2023	AP 3Phase 3Wire				6761971	1200/577/1-1-1	3.967	NA	Director/D	
B.6403	South	BARNALA	11KV	DS CITY DIVN. BARNALA	DS S/D THULIWAL	0238FL13	GURM	AMR	OK	31.03.2023	AP 3Phase 3Wire				6697251	1200/577/1-1-1	4.312	NA	Director/D	
B.6404	South	BARNALA	11KV	DS CITY DIVN. BARNALA	DS S/D THULIWAL	0238FL01	HAMIDI	AMR	OK	31.03.2023	AP 3Phase 3Wire				8223875	1200/577/1-1-1	4.379	NA	Director/D	
B.6405	South	BARNALA	11KV	DS CITY DIVN. BARNALA	DS S/D THULIWAL	0238FL04	MANAL	AMR	OK	31.03.2023	AP 3Phase 3Wire				7336754	1200/577/1-1-1	4.419	NA	Director/D	
B.6406	South	BARNALA	11KV	DS CITY DIVN. BARNALA	DS S/D THULIWAL	0238FL02	JANDSAR	AMR	OK	31.03.2023	AP 3Phase 3Wire				8223872	1200/577/1-1-1	4.464	NA	Director/D	
B.6407	South	BARNALA	11KV	DS CITY DIVN. BARNALA	DS S/D THULIWAL	0238FL06	THULIWAL URBAN	AMR	OK	31.03.2023	Category 5-UPS				7042903	1200/577/1-1-1	4.503	NA	Director/D	
B.6408	South	BARNALA	11KV	DS CITY DIVN. BARNALA	DS S/D THULIWAL	0238FL13	Mawal UPS	NON AMR	OK	31.03.2023	Category 5-UPS				1319076	1200/577/1-1-1	6.945	NA	Director/D	
B.6409	South	BARNALA	11KV	DS CITY DIVN. BARNALA	DS S/D THULIWAL	0238FL26	UPS HAMIDI	AMR	OK	31.03.2023	Category 5-UPS				15193705	1200/577/1-1-1	7.867	NA	Director/D	
B.6410	South	BARNALA	11KV	DS DIVN. DHURI	DS CITY S/D DHURI	8207FL01	Shegar Road	AMR	OK	31.03.2023	Category 2				2067836	1200-600/5	12.545	NA	Director/D	
B.6411	South	BARNALA	11KV	DS DIVN. DHURI	DS CITY S/D DHURI	0250FL20	Organics Cat-4	AMR	OK	31.03.2023	Category 4				9168429	900-450/577/1-1-1	0.096	NA	Director/D	
B.6412	South	BARNALA	11KV	DS DIVN. DHURI	DS CITY S/D DHURI	0250FL14	Civil Hospital	NON AMR	OK	31.03.2023	Category 4				11052040	900-450/577/1-1-1	0.176	NA	Director/D	
B.6413	South	BARNALA	11KV	DS DIVN. DHURI	DS CITY S/D DHURI	0250FL07	New Anja Mandi	NON AMR	OK	31.03.2023	Category 1				15237389	900-450/577/1-1-1	4.725	NA	Director/D	
B.6414	South	BARNALA	11KV	DS DIVN. DHURI	DS CITY S/D DHURI	0250FL19	Chems Road	AMR	OK	31.03.2023	Category 1				15193716	1200/577/1-1-1	10.137	NA	Director/D	
B.6415	South	BARNALA	11KV	DS DIVN. DHURI	DS CITY S/D DHURI	0250FL06	Sangur road	AMR	OK	31.03.2023	Category 2				15193802	900-450/577/1-1-1	14.692	NA	Director/D	
B.6416	South	BARNALA	11KV	DS DIVN. DHURI	DS CITY S/D DHURI	0250FL02	A P Solvek	AMR	OK	31.03.2023	Category 4				15193863	900-450/577/1-1-1	19.547	NA	Director/D	
B.6417	South	BARNALA	11KV	DS DIVN. DHURI	DS CITY S/D DHURI	0207FL12	Sugar Mill	AMR	OK	31.03.2023	Category 2				2067778	1200/577/1-1-1	0.572	NA	Director/D	
B.6418	South	BARNALA	11KV	DS DIVN. DHURI	DS CITY S/D DHURI	0207FL21	11 kv Rambagh	AMR	OK	31.03.2023	Category 1				2068236	1200/577/1-1-1	4.410	NA	Director/D	
B.6419	South	BARNALA	11KV	DS DIVN. DHURI	DS CITY S/D DHURI	0207FL13	Chh	AMR	OK	31.03.2023	Category 1				2068298	1200/577/1-1-1	6.666	NA	Director/D	
B.6420	South	BARNALA	11KV	DS DIVN. DHURI	DS CITY S/D DHURI	0207FL10	M V Road	AMR	OK	31.03.2023	Category 1				6676879	1200/577/1-1-1	7.587	NA	Director/D	
B.6421	South	BARNALA	11KV	DS DIVN. DHURI	DS CITY S/D DHURI	0207FL17	Gaushala Road	AMR	OK	31.03.2023	Category 1				8223403	1200/577/1-1-1	7.902	NA	Director/D	
B.6422	South	BARNALA	11KV	DS DIVN. DHURI	DS CITY S/D DHURI	0207FL06	Markfed	AMR	OK	31.03.2023	Category 1				2068680	1200/577/1-1-1	10.408	NA	Director/D	
B.6423	South	BARNALA	11KV	DS DIVN. DHURI	DS CITY S/D DHURI	0207FL15	Dharampura	AMR	OK	31.03.2023	Category 1				2068236	1200/577/1-1-1	10.435	NA	Director/D	
B.6424	South	BARNALA	11KV	DS DIVN. DHURI	DS CITY S/D DHURI	0207FL04	City-1	NON AMR	OK	31.03.2023	Category 1				6676973	1200/577/1-1-1	11.998	NA	Director/D	
B.6425	South	BARNALA	11KV	DS DIVN. DHURI	DS S/D BHALWAN	0250FL13	Mehar 2	AMR	OK	31.03.2023	AP 3Phase 3Wire				8223181	1200/577/1-1-1	3.105	NA	Director/D	
B.6426	South	BARNALA	11KV	DS DIVN. DHURI	DS S/D BHALWAN	0207FL09	Mehar 1	AMR	OK	31.03.2023	AP 3Phase 3Wire				8223180	1200/577/1-1-1	2.085	NA	Director/D	
B.6427	South	BARNALA	11KV	DS DIVN. DHURI	DS S/D BHALWAN	0207FL22	Kaulseri	AMR	OK	31.03.2023	AP 3Phase 3Wire				40480	1200/577/1-1-1	2.418	NA	Director/D	
B.6428	South	BARNALA	11KV	DS DIVN. DHURI	DS S/D BHALWAN	X22FL08	DITPUR	AMR	OK	31.03.2023	AP 3Phase 3Wire				15193884	1200/577/1-1-1	0.660	NA	Director/D	
B.6429	South	BARNALA	11KV	DS DIVN. DHURI	DS S/D BHALWAN	X22FL09	Falgarg	AMR	OK	31.03.2023										

S.No	Zone	Circle	Voltage Level (kVA)	Division (kVA)	Sub-Division (kVA)	Feeder ID	Feeder Name	Feeder Metering Status (Metred/unmetred/AMR/AM)	Status of Meter (Functional/Non-Functional)	Metering Date (Date of last actual meter reading/communication)	Feeder Type (Agr/Industrial/Mixed)	Status of Communication			Period from 01.04.2021 to 31.03.2022				Sales	Remarks (Source of data)
												% data received through automatically if feeder AMR/AM	Number of hours when meter was unable to communicate in overall	Total Number of hours in the period	Meter S.No	CT/PT ratio	Import (kU)	Export (kU)		
B.6469	South	BARNALA	11KV	DS DIVN. DHURI	DS S/D NO. 2 SHERPUR	D029FL18	Gnanaur Kalan-2	AMR	OK	31.03.2023	AP 3Phase 3Wire				8223451	1200/577/1-1-1	2.176	NA	Director/D	
B.6470	South	BARNALA	11KV	DS DIVN. DHURI	DS S/D NO. 2 SHERPUR	D029FL12	Mahmadpur 1	AMR	OK	31.03.2023	AP 3Phase 3Wire				8222521	1200/577/1-1-1	2.697	NA	Director/D	
B.6471	South	BARNALA	11KV	DS DIVN. DHURI	DS S/D NO. 2 SHERPUR	D029FL06	Surbakpura-1	AMR	OK	31.03.2023	AP 3Phase 3Wire				8223452	1200/577/1-1-1	2.996	NA	Director/D	
B.6472	South	BARNALA	11KV	DS DIVN. DHURI	DS S/D NO. 2 SHERPUR	D029FL09	Pharwah	AMR	OK	31.03.2023	AP 3Phase 3Wire				8223252	1200/577/1-1-1	4.212	NA	Director/D	
B.6473	South	BARNALA	11KV	DS DIVN. DHURI	DS S/D NO. 2 SHERPUR	D029FL08	Kaleran	AMR	OK	31.03.2023	AP 3Phase 3Wire				8223190	1200/577/1-1-1	4.831	NA	Director/D	
B.6474	South	BARNALA	11KV	DS DIVN. DHURI	DS S/D NO. 2 SHERPUR	D029FL01	Roorgah	AMR	OK	31.03.2023	Category 5-UPS				8223023	1200/577/1-1-1	7.483	NA	Director/D	
B.6475	South	BARNALA	11KV	DS DIVN. DHURI	DS S/D NO-1 SHERPUR	D078FL07	Tibba no2	NON AMR	OK	31.03.2023	AP 3Phase 3Wire				37111	1200/577/1-1-1	2.114	NA	Director/D	
B.6476	South	BARNALA	11KV	DS DIVN. DHURI	DS S/D NO-1 SHERPUR	D078FL05	barri 2	AMR	OK	31.03.2023	AP 3Phase 3Wire				33654	1200/577/1-1-1	2.810	NA	Director/D	
B.6477	South	BARNALA	11KV	DS DIVN. DHURI	DS S/D NO-1 SHERPUR	FL11FL13	Dharki Wala Kheri 66 kv	NON AMR	OK	31.03.2023	AP 3Phase 3Wire				88887	1200-600/5	1.867	NA	Director/D	
B.6478	South	BARNALA	11KV	DS DIVN. DHURI	DS S/D NO-1 SHERPUR	D078FL02	Sherpur A.P.2	NON AMR	OK	31.03.2023	AP 3Phase 3Wire				43204	1200-600/5	2.209	NA	Director/D	
B.6479	South	BARNALA	11KV	DS DIVN. DHURI	DS S/D NO-1 SHERPUR	FL08D209	ENNA BAIWA	NON AMR	OK	31.03.2023	AP 3Phase 3Wire				4326	1200-600/5	2.503	NA	Director/D	
B.6480	South	BARNALA	11KV	DS DIVN. DHURI	DS S/D NO-1 SHERPUR	D078FL05	Kheri A.P.3	NON AMR	OK	31.03.2023	AP 3Phase 3Wire				43220	1200-600/5	2.599	NA	Director/D	
B.6481	South	BARNALA	11KV	DS DIVN. DHURI	DS S/D NO-1 SHERPUR	D078FL06	Kheri Cat.No1	NON AMR	OK	31.03.2023	Category 1				43184	1200-600/5	4.274	NA	Director/D	
B.6482	South	BARNALA	11KV	DS DIVN. DHURI	DS S/D NO-1 SHERPUR	D078FL09	Bajwa Ups	AMR	OK	31.03.2023	Category 5-UPS				36786	1200-600/5	4.687	NA	Director/D	
B.6483	South	BARNALA	11KV	DS DIVN. DHURI	DS S/D NO-1 SHERPUR	D029FL02	Tibba	AMR	OK	31.03.2023	AP 3Phase 3Wire				9140860	1200/577/1-1-1	1.899	NA	Director/D	
B.6484	South	BARNALA	11KV	DS DIVN. DHURI	DS S/D NO-1 SHERPUR	D029FL07	Baribar	AMR	OK	31.03.2023	AP 3Phase 3Wire				8223188	1200/577/1-1-1	2.142	NA	Director/D	
B.6485	South	BARNALA	11KV	DS DIVN. DHURI	DS S/D NO-1 SHERPUR	D029FL19	Sherpur	AMR	OK	31.03.2023	AP 3Phase 3Wire				8222523	1200/577/1-1-1	2.290	NA	Director/D	
B.6486	South	BARNALA	11KV	DS DIVN. DHURI	DS S/D NO-1 SHERPUR	D029FL05	Enna Bajwa	AMR	OK	31.03.2023	AP 3Phase 3Wire				8223454	1200/577/1-1-1	2.897	NA	Director/D	
B.6487	South	BARNALA	11KV	DS DIVN. DHURI	DS S/D NO-1 SHERPUR	D029FL16	Katron	AMR	OK	31.03.2023	AP 3Phase 3Wire				8223100	1200/577/1-1-1	4.127	NA	Director/D	
B.6488	South	BARNALA	11KV	DS DIVN. DHURI	DS S/D NO-1 SHERPUR	D029FL03	Galdindrupa	AMR	OK	31.03.2023	AP 3Phase 3Wire				8223186	1200/577/1-1-1	4.540	NA	Director/D	
B.6489	South	BARNALA	11KV	DS DIVN. DHURI	DS S/D NO-1 SHERPUR	D029FL20	KATRON 1	AMR	OK	31.03.2023	Category 1				8223189	1200/577/1-1-1	6.625	NA	Director/D	
B.6490	South	BARNALA	11KV	DS DIVN. DHURI	DS S/D NO-1 SHERPUR	D029FL14	Kheri AP	AMR	OK	31.03.2023	AP 3Phase 3Wire				8223453	1200/577/1-1-1	4.843	NA	Director/D	
B.6491	South	BARNALA	11KV	DS DIVN. DHURI	DS S/D NO-1 SHERPUR	D029FL13	Didargah	AMR	OK	31.03.2023	AP 3Phase 3Wire				8223187	1200/577/1-1-1	5.015	NA	Director/D	
B.6492	South	BARNALA	11KV	DS DIVN. DHURI	DS S/D NO-1 SHERPUR	D029FL11	Bhagwanpura	AMR	OK	31.03.2023	Category 5-UPS				4221184	1200/577/1-1-1	8.397	NA	Director/D	
B.6493	South	BARNALA	11KV	DS DIVN. DHURI	DS S/D NO-1 SHERPUR	D029FL04	Sherpur Urban	AMR	OK	31.03.2023	Category 1				6679871	1200/577/1-1-1	11.973	NA	Director/D	
B.6494	South	BARNALA	11KV	DS DIVN. DHURI	DS S/D NO-1 SHERPUR	D029FL10	Sherpur Road	AMR	OK	31.03.2023	AP 3Phase 3Wire				8223879	1200/577/1-1-1	2.543	NA	Director/D	
B.6495	South	BARNALA	11KV	DS DIVN. DHURI	DS S/D RANGIAN	D078FL03	Tarwani AP	NON AMR	OK	31.03.2023	AP 3Phase 3Wire				22222	900-450/577/1-1-1	0.070	NA	Director/D	
B.6496	South	BARNALA	11KV	DS DIVN. DHURI	DS S/D RANGIAN	D078FL08	NARAINSAR	NON AMR	OK	31.03.2023	AP 3Phase 3Wire				7301082	900-450/577/1-1-1	1.422	NA	Director/D	
B.6497	South	BARNALA	11KV	DS DIVN. DHURI	DS S/D RANGIAN	D078FL02	JHALLOR	NON AMR	OK	31.03.2023	Category 1				7301122	900-450/577/1-1-1	2.510	NA	Director/D	
B.6498	South	BARNALA	11KV	DS DIVN. DHURI	DS S/D RANGIAN	D078FL03	Sank Kuteia	NON AMR	OK	31.03.2023	AP 3Phase 3Wire				43200	1200-600/5	2.192	NA	Director/D	
B.6499	South	BARNALA	11KV	DS DIVN. DHURI	DS S/D RANGIAN	D078FL04	Barkhor Singh wala	AMR	OK	31.03.2023	AP 3Phase 3Wire				43217	1200-600/5	2.536	NA	Director/D	
B.6500	South	BARNALA	11KV	DS DIVN. DHURI	DS S/D RANGIAN	D078FL18	New Salempur UPS	NON AMR	OK	31.03.2023	Category 5-UPS				5452	900-450/577/1-1-1	0.095	NA	Director/D	
B.6501	South	BARNALA	11KV	DS DIVN. DHURI	DS S/D RANGIAN	X05FL16	BABA SAHID AP	NON AMR	OK	31.03.2023	AP 3Phase 3Wire				4089	900-450/577/1-1-1	1.266	NA	Director/D	
B.6502	South	BARNALA	11KV	DS DIVN. DHURI	DS S/D RANGIAN	n.a.n.a-	Mullowal 2	NON AMR	OK	31.03.2023	AP 3Phase 3Wire				23598	900-450/577/1-1-1	2.200	NA	Director/D	
B.6503	South	BARNALA	11KV	DS DIVN. DHURI	DS S/D RANGIAN	D078FL15	Salampur 2	AMR	OK	31.03.2023	AP 3Phase 3Wire				33989	900-450/577/1-1-1	2.375	NA	Director/D	
B.6504	South	BARNALA	11KV	DS DIVN. DHURI	DS S/D RANGIAN	N.A.N.A	BABA DYAL DASS AP	NON AMR	OK	31.03.2023	AP 3Phase 3Wire				9534536	900-450/577/1-1-1	2.753	NA	Director/D	
B.6505	South	BARNALA	11KV	DS DIVN. DHURI	DS S/D RANGIAN	D0210FL13	11 kv Kheri Sahib	NON AMR	OK	31.03.2023	AP 3Phase 3Wire				23281	900-450/577/1-1-1	2.534	NA	Director/D	
B.6506	South	BARNALA	11KV	DS DIVN. DHURI	DS S/D RANGIAN	D0210FL15	Qila Hakimia	AMR	OK	31.03.2023	AP 3Phase 3Wire				21293	900-450/577/1-1-1	2.568	NA	Director/D	
B.6507	South	BARNALA	11KV	DS DIVN. DHURI	DS S/D RANGIAN	D0210FL05	Jaganwala	AMR	OK	31.03.2023	AP 3Phase 3Wire				8223191	900-450/577/1-1-1	2.694	NA	Director/D	
B.6508	South	BARNALA	11KV	DS DIVN. DHURI	DS S/D RANGIAN	D0210FL02	Kanjha AP	AMR	OK	31.03.2023	AP 3Phase 3Wire				8223195	900-450/577/1-1-1	2.797	NA	Director/D	
B.6509	South	BARNALA	11KV	DS DIVN. DHURI	DS S/D RANGIAN	D0210FL04	Natt	AMR	OK	31.03.2023	AP 3Phase 3Wire				8223192	900-450/577/1-1-1	2.969	NA	Director/D	
B.6510	South	BARNALA	11KV	DS DIVN. DHURI	DS S/D RANGIAN	D0210FL10	Kanjha AP	AMR	OK	31.03.2023	AP 3Phase 3Wire				9154463	900-450/577/1-1-1	2.969	NA	Director/D	
B.6511	South	BARNALA	11KV	DS DIVN. DHURI	DS S/D RANGIAN	D0210FL12	HASANPUR	AMR	OK	31.03.2023	AP 3Phase 3Wire				23293	900-450/577/1-1-1	3.063	NA	Director/D	
B.6512	South	BARNALA	11KV	DS DIVN. DHURI	DS S/D RANGIAN	D0210FL01	Kanjha City	AMR	OK	31.03.2023	Category 1				2067381	900-450/577/1-1-1	4.211	NA	Director/D	
B.6513	South	BARNALA	11KV	DS DIVN. DHURI	DS S/D RANGIAN	D0210FL16	11 KV NAT	NON AMR	OK	31.03.2023	Category 5-UPS				9154463	900-450/577/1-1-1	5.870	NA	Director/D	
B.6514	South	BARNALA	11KV	DS DIVN. DHURI	DS S/D RANGIAN	D024FL14	JALODR ROAD	NON AMR	OK	31.03.2023	AP 3Phase 3Wire				36973	1200/577/1-1-1	2.058	NA	Director/D	
B.6515	South	BARNALA	11KV	DS DIVN. DHURI	DS S/D RANGIAN	D024FL18	Kumber Wali Road AP	NON AMR	OK	31.03.2023	AP 3Phase 3Wire				34953	900-450/577/1-1-1	2.412	NA	Director/D	
B.6516	South	BARNALA	11KV	DS DIVN. DHURI	DS S/D RANGIAN	D024FL08	Kila	AMR	OK	31.03.2023	AP 3Phase 3Wire				362948	900-450/577/1-1-1	2.976	NA	Director/D	
B.6517	South	BARNALA	11KV	DS DIVN. DHURI	DS S/D RANGIAN	D024FL07	Qila Road/Balain	AMR	OK	31.03.2023	AP 3Phase 3Wire				8223859	900-450/577/1-1-1	6.200	NA	Director/D	
B.6518	South	BARNALA	11KV	DS DIVN. DHURI	DS S/D RANGIAN	D0208FL07	Kanjha (Rangian)	AMR	OK	31.03.2023	AP 3Phase 3Wire				9140864	1200/577/1-1-1	0.000	NA	Director/D	
B.6519	South	BARNALA	11KV	DS DIVN. DHURI	DS S/D RANGIAN	D0208FL08	Herike	AMR	OK	31.03.2023	AP 3Phase 3Wire				8223879	900-450/577/1-1-1	0.000	NA	Director/D	
B.6520	South	BARNALA	11KV	DS DIVN. DHURI	DS S/D RANGIAN	D0208N/A	SACHOWAL AP	AMR	OK	31.03.2023	AP 3Phase 3Wire				9154002	900-450/577/1-1-1	0.000	NA	Director/D	
B.6521	South	BARNALA	11KV	DS DIVN. DHURI	DS S/D RANGIAN	D0208FL21	Lehwala(Branch)	AMR	OK	31.03.2023	AP 3Phase 3Wire				11117234	900-450/577/1-1-1	0.000	NA	Director/D	
B.6522	South	BARNALA	11KV	DS DIVN. DHURI	DS S/D RANGIAN	D0208FL15	Nayan Sar	AMR	OK	31.03.2023	AP 3Phase 3Wire				8223956	1200/577/1-1-1	0.438	NA	Director/D	
B.6523	South	BARNALA	11KV	DS DIVN. DHURI	DS S/D RANGIAN	D0208FL06	Jhalool	AMR	OK	31.03.2023	AP 3Phase 3Wire				8222953	900-450/577/1-1-1	1.603	NA	Director/D	
B.6524	South	BARNALA	11KV	DS DIVN. DHURI	DS S/D RANGIAN	D0208FL16	Ranike	AMR	OK	31.03.2023	AP 3Phase 3Wire				8222959	1200/577/1-1-1	1.882	NA	Director/D	
B.6525	South	BARNALA	11KV	DS DIVN. DHURI	DS S/D RANGIAN	D0208FL17	Enna Bajwa	AMR	OK	31.03.2023	AP 3Phase 3Wire				8222960	1200/577/1-1-1	2.352	NA	Director/D	
B.6526	South	BARNALA	11KV	DS DIVN. DHURI	DS S/D RANGIAN	D0208FL10	Ghanauri Khurd	AMR	OK	31.03.2023	AP 3Phase 3Wire				8223788	900-450/577/1-1-1	2.372	NA	Director/D	
B.6527	South	BARNALA	11KV	DS DIVN. DHURI	DS S/D RANGIAN	D0208FL19	Subhanpur	AMR	OK	31.03.2023	AP 3Phase 3Wire				8223784	900-450/577/1-1-1	2.466	NA	Director/D	
B.6528	South	BARNALA	11KV	DS DIVN. DHURI	DS S/D RANGIAN	D0208DL20	SIDH BHCHI	NON AMR	OK	31.03.2023	AP 3Phase 3Wire				11117268	1200/577/1-1-1	2.656	NA	Director/D	
B.6529	South	BARNALA	11KV	DS DIVN. DHURI	DS S/D RANGIAN	D0208FL	YRC	AMR	OK	31.03.2023	Category 5-UPS				22222	1200/577/1-1-1	2.690	NA	Director/D	
B.6530	South	BARNALA	11KV	DS DIVN. DHURI	DS S/D RANGIAN	D0208FL12	Dhandwal	AMR	OK	31.03.2023	AP 3Phase 3Wire				9140862	1200/577/1-1-1	2.960	NA	Director/D	
B.6531	South	BARNALA	11KV	DS DIVN. DHURI	DS S/D RANGIAN	D0208FL20	Shiv Mandir(Branch)	AMR	OK	31.03.2023	AP 3Phase 3Wire				8222956	900-450/577/1-1-1	3.037	NA	Director/D	
B.6532	South	BARNALA	11KV	DS DIVN. DHURI	DS S/D RANGIAN	D0208FL32	Bhathewala AP	AMR	OK	31.03.2023	AP 3Phase 3Wire				9140862	900-450/577/1-1-1	3.048	NA	Director/D	
B.6533	South	BARNALA	11KV	DS DIVN. DHURI	DS S/D RANGIAN	D0														

S.No	Zone	Circle	Voltage Level (kVA)	Division (kVA)	Sub-Division (kVA)	Feeder ID	Feeder Name	Feeder Metering Status (Metred/unmetred/AMR/AMI)	Status of Meter (Functional/Non-functional)	Metering Date (Date of last actual meter reading/communication)	Feeder Type (Agr/Industrial/Mixed)	Status of Communication			Period from 01.04.2021 to 31.03.2022				Sales	Remarks (Source of data)
												% data received through automatically by feeder AMR/AMI	Number of hours when meter was unable to communicate in overall	Total Number of hours in the period	Meter S.No	CT/Ratio	Import (kU)	Export (kU)		
B.6566	South	BARNALA	11KV	DS DIVN. DHURI	DS S/U S/D DHURI	D207FL16	Industrial (Dhuri)	AMR	OK	31.03.2023	Category 2				8223403	1200/577/1-1-1	7.971	NA	Director/D	
B.6567	South	BARNALA	11KV	DS DIVN. DHURI	DS S/U S/D DHURI	D207FL20	11 kv Dhoba Road	AMR	OK	31.03.2023	Category 2				8223178	1200/577/1-1-1	8.520	NA	Director/D	
B.6568	South	BARNALA	11KV	DS DIVN. DHURI	DS S/U S/D DHURI	D207FL02	Bajrang Road	AMR	OK	31.03.2023	Category 5-UPS				6679856	1200/577/1-1-1	9.011	NA	Director/D	
B.6569	South	BARNALA	11KV	DS DIVN. DHURI	DS S/U S/D DHURI	D216FL06	Isra Bahar	AMR	OK	31.03.2023	AP 3Phase 3Wire				9154279	900/450/577/1-1-1	4.244	NA	Director/D	
B.6570	South	BARNALA	11KV	DS DIVN. DHURI	DS S/U S/D DHURI	---	INDUSTRIAL CAT-II (Bhasour)	NON AMR	OK	31.03.2023	Category 2				12052475	900/450/577/1-1-1	0.638	NA	Director/D	
B.6571	South	BARNALA	11KV	DS DIVN. DHURI	DS S/U S/D DHURI	---	Bhasur	NON AMR	OK	31.03.2023	AP 3Phase 3Wire				7336713	900/450/577/1-1-1	2.388	NA	Director/D	
B.6572	South	BARNALA	11KV	DS DIVN. DHURI	DS S/U S/D DHURI	---	Banbhari	NON AMR	OK	31.03.2023	AP 3Phase 3Wire				7042931	900/450/577/1-1-1	2.444	NA	Director/D	
B.6573	South	BARNALA	11KV	DS DIVN. DHURI	DS S/U S/D DHURI	TB03FL06	RULDU SINGH WALA	NON AMR	OK	31.03.2023	AP 3Phase 3Wire				23511	900/450/577/1-1-1	2.686	NA	Director/D	
B.6574	South	BARNALA	11KV	DS DIVN. DHURI	DS S/U S/D DHURI	TB03FL07	BANBANPUR	NON AMR	OK	31.03.2023	AP 3Phase 3Wire				23555	900/450/577/1-1-1	2.711	NA	Director/D	
B.6575	South	BARNALA	11KV	DS DIVN. DHURI	DS S/U S/D DHURI	---	Bangawali	AMR	OK	31.03.2023	AP 3Phase 3Wire				7336827	900/450/577/1-1-1	2.855	NA	Director/D	
B.6576	South	BARNALA	11KV	DS DIVN. DHURI	DS S/U S/D DHURI	---	City	NON AMR	OK	31.03.2023	Category 1				7336724	900/450/577/1-1-1	3.576	NA	Director/D	
B.6577	South	BARNALA	11KV	DS DIVN. DHURI	DS S/U S/D DHURI	TB03FL03	ESSI	NON AMR	OK	31.03.2023	AP 3Phase 3Wire				24357	900/450/577/1-1-1	3.709	NA	Director/D	
B.6578	South	BARNALA	11KV	DS DIVN. DHURI	DS S/U S/D DHURI	---	Rajindrapuri	AMR	OK	31.03.2023	Category 5-UPS				7336830	900/450/577/1-1-1	7.113	NA	Director/D	
B.6579	South	BARNALA	11KV	DS DIVN. DHURI	DS S/U S/D DHURI	---	Bashahpur-2	AMR	OK	31.03.2023	AP 3Phase 3Wire				9534490	900/450/577/1-1-1	2.285	NA	Director/D	
B.6580	South	BARNALA	11KV	DS DIVN. DHURI	DS S/U S/D DHURI	---	Gahansuri Kalan	NON AMR	OK	31.03.2023	AP 3Phase 3Wire				9154204	900/450/577/1-1-1	2.307	NA	Director/D	
B.6581	South	BARNALA	11KV	DS DIVN. DHURI	DS S/U S/D DHURI	TB03FL08	Nanaskar	NON AMR	OK	31.03.2023	AP 3Phase 3Wire				23517	900/450/577/1-1-1	2.680	NA	Director/D	
B.6582	South	BARNALA	11KV	DS DIVN. DHURI	DS S/U S/D DHURI	TB03FL07	Bugra 2	AMR	OK	31.03.2023	AP 3Phase 3Wire				23409	900/450/577/1-1-1	2.750	NA	Director/D	
B.6583	South	BARNALA	11KV	DS DIVN. DHURI	DS S/U S/D DHURI	TB03FL10	UPS Badshahpur	NON AMR	OK	31.03.2023	Category 5-UPS				33989	900/450/577/1-1-1	8.739	NA	Director/D	
B.6584	South	BARNALA	11KV	DS DIVN. DHURI	DS S/U S/D DHURI	D210FL17	GUGA MAARHI	AMR	OK	31.03.2023	AP 3Phase 3Wire				36892	900/450/577/1-1-1	1.713	NA	Director/D	
B.6585	South	BARNALA	11KV	DS DIVN. DHURI	DS S/U S/D DHURI	D210FL09	Padm-2 (Kanji)	AMR	OK	31.03.2023	AP 3Phase 3Wire				9154477	900/450/577/1-1-1	2.448	NA	Director/D	
B.6586	South	BARNALA	11KV	DS DIVN. DHURI	DS S/U S/D DHURI	D210FL11	11th BHM SANGH	AMR	OK	31.03.2023	AP 3Phase 3Wire				23268	900/450/577/1-1-1	2.754	NA	Director/D	
B.6587	South	BARNALA	11KV	DS DIVN. DHURI	DS S/U S/D DHURI	D210FL06	Ladda kothi	AMR	OK	31.03.2023	AP 3Phase 3Wire				8223193	900/450/577/1-1-1	2.839	NA	Director/D	
B.6588	South	BARNALA	11KV	DS DIVN. DHURI	DS S/U S/D DHURI	D210FL08	Bugga	AMR	OK	31.03.2023	AP 3Phase 3Wire				8223193	900/450/577/1-1-1	2.878	NA	Director/D	
B.6589	South	BARNALA	11KV	DS DIVN. DHURI	DS S/U S/D DHURI	D210FL03	Punnawal-2 (Kanjiha)	AMR	OK	31.03.2023	AP 3Phase 3Wire				8223194	900/450/577/1-1-1	3.312	NA	Director/D	
B.6590	South	BARNALA	11KV	DS DIVN. DHURI	DS S/U S/D DHURI	D210FL07	Punnawal UPS	Not available	OK	31.03.2023	Category 5-UPS				10282799	900/450/577/1-1-1	9.899	NA	Director/D	
B.6591	South	BARNALA	11KV	DS DIVN. DHURI	DS S/U S/D DHURI	D207FL02	KRBL Ltd. Bhasour	AMR	OK	31.03.2023	Category 4				Not available	Not available	6.367	NA	Director/D	
B.6592	South	BARNALA	11KV	DS DIVN. MALERKOTLA	DS S/D CITY-1 MALERKOTLA	D211FL17	HOSPITAL	AMR	OK	31.03.2023	Category 4				23403	1200/577/1-1-1	0.530	NA	Director/D	
B.6593	South	BARNALA	11KV	DS DIVN. MALERKOTLA	DS S/D CITY-1 MALERKOTLA	D211FL07	Industrial-1	AMR	OK	31.03.2023	Category 1				4221160	1200/577/1-1-1	4.040	NA	Director/D	
B.6594	South	BARNALA	11KV	DS DIVN. MALERKOTLA	DS S/D CITY-1 MALERKOTLA	D211FL10	Industrial-2	AMR	OK	31.03.2023	Category 2				36707	1200/577/1-1-1	7.725	NA	Director/D	
B.6595	South	BARNALA	11KV	DS DIVN. MALERKOTLA	DS S/D CITY-1 MALERKOTLA	D211FH21	QUILA REHMATGARH	AMR	OK	31.03.2023	Category 1				9168418	1200/577/1-1-1	8.809	NA	Director/D	
B.6596	South	BARNALA	11KV	DS DIVN. MALERKOTLA	DS S/D CITY-1 MALERKOTLA	D211FL12	SHANGANGRAM	AMR	OK	31.03.2023	Category 1				5437	1200/577/1-1-1	10.291	NA	Director/D	
B.6597	South	BARNALA	11KV	DS DIVN. MALERKOTLA	DS S/D CITY-1 MALERKOTLA	D211FL20	LOHA BAZAR	AMR	OK	31.03.2023	Category 1				579606	1200/577/1-1-1	10.643	NA	Director/D	
B.6598	South	BARNALA	11KV	DS DIVN. MALERKOTLA	DS S/D CITY-1 MALERKOTLA	D211FL06	MALERKOTLA-1	Not available	OK	31.03.2023	Category 1				9168458	1200/577/1-1-1	15.134	NA	Director/D	
B.6599	South	BARNALA	66KV	DS DIVN. MALERKOTLA	DS S/D CITY-1 MALERKOTLA	B201DL12	Arihant Spinning Mills Milk	NON AMR	OK	31.03.2023	Category 4				Not available	Not available	85.960	NA	Director/D	
B.6600	South	BARNALA	11KV	DS DIVN. MALERKOTLA	DS S/D CITY-2 MALERKOTLA	B201FT99	SUB STATION 220 KV MALERKOTLA	AMR	OK	31.03.2023	Substation Transformer				99	1200/577/1-1-1	0.001	NA	Director/D	
B.6601	South	BARNALA	11KV	DS DIVN. MALERKOTLA	DS S/D CITY-2 MALERKOTLA	B201FL06	GIRD CONNECTION	AMR	OK	31.03.2023	Category 4				2047174	1200/577/1-1-1	0.042	NA	Director/D	
B.6602	South	BARNALA	11KV	DS DIVN. MALERKOTLA	DS S/D CITY-2 MALERKOTLA	D201FL01	P.C.C.A	AMR	OK	31.03.2023	Category 4				2062819	1200/577/1-1-1	0.170	NA	Director/D	
B.6603	South	BARNALA	11KV	DS DIVN. MALERKOTLA	DS S/D CITY-2 MALERKOTLA	B201FL03	RAJINDER NAGAR	AMR	OK	31.03.2023	AP 3Phase 3Wire				8223019	1200/577/1-1-1	2.512	NA	Director/D	
B.6604	South	BARNALA	11KV	DS DIVN. MALERKOTLA	DS S/D CITY-2 MALERKOTLA	B201FL07	MOTI BAZAR	AMR	OK	31.03.2023	Category 1				11116888	1200/577/1-1-1	8.572	NA	Director/D	
B.6605	South	BARNALA	11KV	DS DIVN. MALERKOTLA	DS S/D CITY-2 MALERKOTLA	B201F05	SAROUD UPS	AMR	OK	31.03.2023	Category 5-UPS				2068555	1200/577/1-1-1	11.472	NA	Director/D	
B.6606	South	BARNALA	11KV	DS DIVN. MALERKOTLA	DS S/D CITY-2 MALERKOTLA	B201F09	LUDHIANA ROAD	AMR	OK	31.03.2023	Category 2				8223107	1200/577/1-1-1	12.903	NA	Director/D	
B.6607	South	BARNALA	11KV	DS DIVN. MALERKOTLA	DS S/D CITY-2 MALERKOTLA	B201FL11	JAMALPURA	NON AMR	OK	31.03.2023	Category 1				4221040	1200/577/1-1-1	13.524	NA	Director/D	
B.6608	South	BARNALA	11KV	DS DIVN. MALERKOTLA	DS S/D CITY-2 MALERKOTLA	B201FL03	SARAWANPUR	AMR	OK	31.03.2023	AP 3Phase 3Wire				231199	1200/600/5	2.163	NA	Director/D	
B.6609	South	BARNALA	11KV	DS DIVN. MALERKOTLA	DS S/D CITY-2 MALERKOTLA	D213FL07	Industrial-2	AMR	OK	31.03.2023	Category 2				4221009	900/450/577/1-1-1	11.120	NA	Director/D	
B.6610	South	BARNALA	11KV	DS DIVN. MALERKOTLA	DS S/D CITY-2 MALERKOTLA	D211FL02	GURUDWARA HAA DA NARA	AMR	OK	31.03.2023	Category 1				2068399	1200/577/1-1-1	8.857	NA	Director/D	
B.6611	South	BARNALA	11KV	DS DIVN. MALERKOTLA	DS S/D CITY-2 MALERKOTLA	D211FL03	MALERKOTLA-2	AMR	OK	31.03.2023	Category 1				2068522	1200/577/1-1-1	10.144	NA	Director/D	
B.6612	South	BARNALA	11KV	DS DIVN. MALERKOTLA	DS S/D KUP-KALAN	B201FL17	DHANO	AMR	OK	31.03.2023	AP 3Phase 3Wire				5388168	1200/577/1-1-1	2.104	NA	Director/D	
B.6613	South	BARNALA	11KV	DS DIVN. MALERKOTLA	DS S/D KUP-KALAN	B201FL04	SAROUD	AMR	OK	31.03.2023	AP 3Phase 3Wire				8223007	1200/577/1-1-1	4.764	NA	Director/D	
B.6614	South	BARNALA	11KV	DS DIVN. MALERKOTLA	DS S/D KUP-KALAN	B201FL12	GOLNUPURA	AMR	OK	31.03.2023	AP 3Phase 3Wire				8223018	1200/577/1-1-1	6.250	NA	Director/D	
B.6615	South	BARNALA	11KV	DS DIVN. MALERKOTLA	DS S/D KUP-KALAN	B201FL10	UPS DULMAN	AMR	OK	31.03.2023	Category 5-UPS				5388168	1200/577/1-1-1	9.191	NA	Director/D	
B.6616	South	BARNALA	220KV	DS DIVN. MALERKOTLA	DS S/D KUP-KALAN	NAF01	220 KV Railway Traction Kup	NON AMR	OK	31.03.2023	Category 4				52076	1200/577/1-1-1	3.245	NA	Director/D	
B.6617	South	BARNALA	11KV	DS DIVN. MALERKOTLA	DS S/D KUP-KALAN	D213FL99	SUB STATION KUP KALAN	AMR	OK	31.03.2023	Substation Transformer				99	1200/577/1-1-1	0.033	NA	Director/D	
B.6618	South	BARNALA	11KV	DS DIVN. MALERKOTLA	DS S/D KUP-KALAN	D213FL11	TARA FEED	AMR	OK	31.03.2023	Category 4				2959737	900/450/577/1-1-1	1.601	NA	Director/D	
B.6619	South	BARNALA	11KV	DS DIVN. MALERKOTLA	DS S/D KUP-KALAN	D213FL13	RAHVA	AMR	OK	31.03.2023	AP 3Phase 3Wire				5342470	1200/577/1-1-1	2.925	NA	Director/D	
B.6620	South	BARNALA	11KV	DS DIVN. MALERKOTLA	DS S/D KUP-KALAN	D213FL04	ROHRA	AMR	OK	31.03.2023	AP 3Phase 3Wire				5342470	1200/577/1-1-1	2.272	NA	Director/D	
B.6621	South	BARNALA	11KV	DS DIVN. MALERKOTLA	DS S/D KUP-KALAN	D213FL02	Raison Carbon	AMR	OK	31.03.2023	Category 4				2067043	1200/577/1-1-1	2.322	NA	Director/D	
B.6622	South	BARNALA	11KV	DS DIVN. MALERKOTLA	DS S/D KUP-KALAN	D213FL17	DHANO-2	AMR	OK	31.03.2023	AP 3Phase 3Wire				8223479	900/450/577/1-1-1	2.338	NA	Director/D	
B.6623	South	BARNALA	11KV	DS DIVN. MALERKOTLA	DS S/D KUP-KALAN	D213FL10	Sarink Textiles	AMR	OK	31.03.2023										

S.No	Zone	Circle	Voltage Level (kVA)	Division (kVA)	Sub-Division (kVA)	Feeder ID	Feeder Name	Feeder Metering Status (Metred/unmetred/AMR/AM)	Status of Meter (Functional/Non-Functional)	Metering Date	Feeder Type (Agr/Industrial/Mixed)	Status of Communication			Period from 01.04.2021 to 31.03.2022				Sales	Remarks (Source of data)
												% Data received through automatically if feeder AMR/AM	Number of hours when meter was unable to communicate in week	Total Number of hours in the period	Meter S.No	CT/PT ratio	Import (kU)	Export (kU)		
B.6663	South	BARNALA	11KV	DS DIVN. MALERKOTLA	DS S/D SANDOUR	0811F108	BASSIAN KOTHEY	AMR	OK	31.03.2023	AP 3Phase 3Wire	9140076	900-450/577/1-1	2.026	NA	Director/D				
B.6664	South	BARNALA	11KV	DS DIVN. MALERKOTLA	DS S/D SANDOUR	0811F102	BASANT GIR OLD	NON AMR	OK	31.03.2023	AP 3Phase 3Wire	220197943	1200/577/1-1-1	2.293	NA	Director/D				
B.6665	South	BARNALA	11KV	DS DIVN. MALERKOTLA	DS S/D SANDOUR	0811F103	TUMBHNERI	NON AMR	OK	31.03.2023	AP 3Phase 3Wire	16199259	1200/577/1-1-1	2.335	NA	Director/D				
B.6666	South	BARNALA	11KV	DS DIVN. MALERKOTLA	DS S/D SANDOUR	0811F105	MOURA	NON AMR	OK	31.03.2023	AP 3Phase 3Wire	20133971	1200/577/1-1-1	2.432	NA	Director/D				
B.6667	South	BARNALA	11KV	DS DIVN. MALERKOTLA	DS S/D SANDOUR	0811F104	JOHLAR ROAD	NON AMR	OK	31.03.2023	AP 3Phase 3Wire	16199250	1200/577/1-1-1	2.836	NA	Director/D				
B.6668	South	BARNALA	11KV	DS DIVN. MALERKOTLA	DS S/D SANDOUR	0811F106	LOHATBADI CAT.1	AMR	OK	31.03.2023	Category 1	201	1200/577/1-1-1	3.124	NA	Director/D				
B.6669	South	BARNALA	11KV	DS DIVN. MALERKOTLA	DS S/D SANDOUR	0811F101	UPS MAHOLI KHURD	AMR	OK	31.03.2023	Category 5-UPS	16199241	1200/577/1-1-1	3.990	NA	Director/D				
B.6670	South	BARNALA	11KV	DS DIVN. MALERKOTLA	DS S/D SANDOUR	0211F106	BADHESHA ROAD	AMR	OK	31.03.2023	AP 3Phase 3Wire	9534454	900-450/577/1-1-1	1.999	NA	Director/D				
B.6671	South	BARNALA	11KV	DS DIVN. MALERKOTLA	DS S/D SANDOUR	0211F108	PANGARUAN (KOTHALA)	AMR	OK	31.03.2023	AP 3Phase 3Wire	9140076	900-450/577/1-1-1	2.026	NA	Director/D				
B.6672	South	BARNALA	11KV	DS DIVN. MALERKOTLA	DS S/D SANDOUR	0214F110	BATHAN	AMR	OK	31.03.2023	AP 3Phase 3Wire	9141054	900-450/577/1-1-1	0.000	NA	Director/D				
B.6673	South	BARNALA	11KV	DS DIVN. MALERKOTLA	DS S/D SANDOUR	0214F118	11kv FOIEVAL AP	AMR	OK	31.03.2023	AP 3Phase 3Wire	9141055	900-450/577/1-1-1	0.000	NA	Director/D				
B.6674	South	BARNALA	11KV	DS DIVN. MALERKOTLA	DS S/D SANDOUR	0214F124	Kangawal Branch	AMR	OK	31.03.2023	AP 3Phase 3Wire	8223117	1200/577/1-1-1	0.000	NA	Director/D				
B.6675	South	BARNALA	11KV	DS DIVN. MALERKOTLA	DS S/D SANDOUR	0214F125	Kalshan Branch	AMR	OK	31.03.2023	AP 3Phase 3Wire	8223299	1200/577/1-1-1	0.000	NA	Director/D				
B.6676	South	BARNALA	11KV	DS DIVN. MALERKOTLA	DS S/D SANDOUR	0214F127	Dhaler Khalan Branch	NON AMR	OK	31.03.2023	AP 3Phase 3Wire	8223297	1200/577/1-1-1	0.000	NA	Director/D				
B.6677	South	BARNALA	11KV	DS DIVN. MALERKOTLA	DS S/D SANDOUR	0214F109	SUB STATION SANDOUR	AMR	OK	31.03.2023	Substation Transformer	99	1200/577/1-1-1	0.226	NA	Director/D				
B.6678	South	BARNALA	11KV	DS DIVN. MALERKOTLA	DS S/D SANDOUR	0214F130	JHUNER	AMR	OK	31.03.2023	AP 3Phase 3Wire	7336587	1200/577/1-1-1	0.918	NA	Director/D				
B.6679	South	BARNALA	11KV	DS DIVN. MALERKOTLA	DS S/D SANDOUR	0214F117	JALWANA	AMR	OK	31.03.2023	AP 3Phase 3Wire	8222963	1200/577/1-1-1	1.269	NA	Director/D				
B.6680	South	BARNALA	11KV	DS DIVN. MALERKOTLA	DS S/D SANDOUR	0214F114	MOHOLI KHURD	AMR	OK	31.03.2023	AP 3Phase 3Wire	8222888	900-450/577/1-1-1	1.295	NA	Director/D				
B.6681	South	BARNALA	11KV	DS DIVN. MALERKOTLA	DS S/D SANDOUR	0214F121	New Pangalain	AMR	OK	31.03.2023	AP 3Phase 3Wire	8223342	1200/577/1-1-1	1.972	NA	Director/D				
B.6682	South	BARNALA	11KV	DS DIVN. MALERKOTLA	DS S/D SANDOUR	0214F107	PANGARUAN (SANDHOUR)	AMR	OK	31.03.2023	AP 3Phase 3Wire	8222687	900-450/577/1-1-1	2.366	NA	Director/D				
B.6683	South	BARNALA	11KV	DS DIVN. MALERKOTLA	DS S/D SANDOUR	0214F115	MANKI (NEW)	AMR	OK	31.03.2023	AP 3Phase 3Wire	9534566	1200/577/1-1-1	2.414	NA	Director/D				
B.6684	South	BARNALA	11KV	DS DIVN. MALERKOTLA	DS S/D SANDOUR	0214F101	MANKI	AMR	OK	31.03.2023	AP 3Phase 3Wire	8222686	900-450/577/1-1-1	2.610	NA	Director/D				
B.6685	South	BARNALA	11KV	DS DIVN. MALERKOTLA	DS S/D SANDOUR	0214F113	NEHRI BATHAN	AMR	OK	31.03.2023	AP 3Phase 3Wire	8223297	1200/577/1-1-1	2.983	NA	Director/D				
B.6686	South	BARNALA	11KV	DS DIVN. MALERKOTLA	DS S/D SANDOUR	0214F102	LOHATBADI	AMR	OK	31.03.2023	AP 3Phase 3Wire	8223299	1200/577/1-1-1	2.992	NA	Director/D				
B.6687	South	BARNALA	11KV	DS DIVN. MALERKOTLA	DS S/D SANDOUR	0214F103	KHURD	AMR	OK	31.03.2023	AP 3Phase 3Wire	8223118	900-450/577/1-1-1	3.209	NA	Director/D				
B.6688	South	BARNALA	11KV	DS DIVN. MALERKOTLA	DS S/D SANDOUR	0214F123	NATKHOEBI	NON AMR	OK	31.03.2023	AP 3Phase 3Wire	1021233	1200/577/1-1-1	3.803	NA	Director/D				
B.6689	South	BARNALA	11KV	DS DIVN. MALERKOTLA	DS S/D SANDOUR	0214F122	Dhalwal Kotha	AMR	OK	31.03.2023	AP 3Phase 3Wire	2049668	1200/577/1-1-1	4.072	NA	Director/D				
B.6690	South	BARNALA	11KV	DS DIVN. MALERKOTLA	DS S/D SANDOUR	0214F106	HUSSANPURA	AMR	OK	31.03.2023	AP 3Phase 3Wire	9141051	1200/577/1-1-1	4.123	NA	Director/D				
B.6691	South	BARNALA	11KV	DS DIVN. MALERKOTLA	DS S/D SANDOUR	0214F116	Chuhne Road	AMR	OK	31.03.2023	AP 3Phase 3Wire	23400	1200/577/1-1-1	4.198	NA	Director/D				
B.6692	South	BARNALA	11KV	DS DIVN. MALERKOTLA	DS S/D SANDOUR	0214F105	KALYAN	AMR	OK	31.03.2023	AP 3Phase 3Wire	9141055	900-450/577/1-1-1	4.324	NA	Director/D				
B.6693	South	BARNALA	11KV	DS DIVN. MALERKOTLA	DS S/D SANDOUR	0214F104	KASSA	AMR	OK	31.03.2023	AP 3Phase 3Wire	9141054	900-450/577/1-1-1	4.472	NA	Director/D				
B.6694	South	BARNALA	11KV	DS DIVN. MALERKOTLA	DS S/D SANDOUR	0214F112	PHARWALI	AMR	OK	31.03.2023	Category 5-UPS	5343272	1200/577/1-1-1	8.463	NA	Director/D				
B.6695	South	BARNALA	11KV	DS DIVN. MALERKOTLA	DS S/D SANDOUR	0214F108	UPS SANDOUR	NON AMR	OK	31.03.2023	Category 5-UPS	5341675	900-450/577/1-1-1	10.359	NA	Director/D				
B.6696	South	BARNALA	11KV	DS DIVN. MALERKOTLA	DS S/D SANDOUR	0214F129	UPS KANGANWAL	AMR	OK	31.03.2023	Category 5-UPS	2064672	1200/577/1-1-1	12.223	NA	Director/D				
B.6697	South	BARNALA	11KV	DS DIVN. MALERKOTLA	DS S/D SHERWANKOT	B2010	MATOI (BRANCH)	AMR	OK	31.03.2023	AP 3Phase 3Wire	8223018	1200/577/1-1-1	0.000	NA	Director/D				
B.6698	South	BARNALA	11KV	DS DIVN. MALERKOTLA	DS S/D SHERWANKOT	B201F108	JITVAL	AMR	OK	31.03.2023	AP 3Phase 3Wire	8223020	1200/577/1-1-1	4.525	NA	Director/D				
B.6699	South	BARNALA	11KV	DS DIVN. MALERKOTLA	DS S/D SHERWANKOT	B201F113	CHAK KHURD	NON AMR	OK	31.03.2023	AP 3Phase 3Wire	8223016	1200/577/1-1-1	5.566	NA	Director/D				
B.6700	South	BARNALA	11KV	DS DIVN. MALERKOTLA	DS S/D SHERWANKOT	0211F190	SUB STATION KUTHALA	AMR	OK	31.03.2023	Substation Transformer	99	900-450/577/1-1-1	0.001	NA	Director/D				
B.6701	South	BARNALA	11KV	DS DIVN. MALERKOTLA	DS S/D SHERWANKOT	0211F117	UPS Pangrian	AMR	OK	31.03.2023	AP 3Phase 3Wire	4064	900-450/577/1-1-1	1.443	NA	Director/D				
B.6702	South	BARNALA	11KV	DS DIVN. MALERKOTLA	DS S/D SHERWANKOT	0211F110	MUBAIRKPUR	NON AMR	OK	31.03.2023	AP 3Phase 3Wire	9140878	900-450/577/1-1-1	2.112	NA	Director/D				
B.6703	South	BARNALA	11KV	DS DIVN. MALERKOTLA	DS S/D SHERWANKOT	0211F114	LANDA	AMR	OK	31.03.2023	AP 3Phase 3Wire	15196201	900-450/577/1-1-1	2.157	NA	Director/D				
B.6704	South	BARNALA	11KV	DS DIVN. MALERKOTLA	DS S/D SHERWANKOT	0211F112	SHANDERPURA	AMR	OK	31.03.2023	AP 3Phase 3Wire	9534489	900-450/577/1-1-1	2.347	NA	Director/D				
B.6705	South	BARNALA	11KV	DS DIVN. MALERKOTLA	DS S/D SHERWANKOT	0211F103	DALIA	AMR	OK	31.03.2023	AP 3Phase 3Wire	9140877	900-450/577/1-1-1	2.468	NA	Director/D				
B.6706	South	BARNALA	11KV	DS DIVN. MALERKOTLA	DS S/D SHERWANKOT	0211F102	BHUDAN	AMR	OK	31.03.2023	AP 3Phase 3Wire	9140879	900-450/577/1-1-1	2.509	NA	Director/D				
B.6707	South	BARNALA	11KV	DS DIVN. MALERKOTLA	DS S/D SHERWANKOT	0211F116	RAI PALACE	AMR	OK	31.03.2023	AP 3Phase 3Wire	15199039	900-450/577/1-1-1	2.633	NA	Director/D				
B.6708	South	BARNALA	11KV	DS DIVN. MALERKOTLA	DS S/D SHERWANKOT	0211F104	KUTHALA FOCAL POINT	AMR	OK	31.03.2023	AP 3Phase 3Wire	8222961	900-450/577/1-1-1	2.647	NA	Director/D				
B.6709	South	BARNALA	11KV	DS DIVN. MALERKOTLA	DS S/D SHERWANKOT	0211F111	BADHRAN	AMR	OK	31.03.2023	AP 3Phase 3Wire	4186540	900-450/577/1-1-1	2.818	NA	Director/D				
B.6710	South	BARNALA	11KV	DS DIVN. MALERKOTLA	DS S/D SHERWANKOT	0211F115	KANGANWAL	AMR	OK	31.03.2023	AP 3Phase 3Wire	2066169	900-450/577/1-1-1	2.906	NA	Director/D				
B.6711	South	BARNALA	11KV	DS DIVN. MALERKOTLA	DS S/D SHERWANKOT	FL13D217	FEROZPUR KUTHALA	AMR	OK	31.03.2023	AP 3Phase 3Wire	206688	900-450/577/1-1-1	2.956	NA	Director/D				
B.6712	South	BARNALA	11KV	DS DIVN. MALERKOTLA	DS S/D SHERWANKOT	0211F101	KUTHALA CAT-1	AMR	OK	31.03.2023	Category 1	679902	900-450/577/1-1-1	3.601	NA	Director/D				
B.6713	South	BARNALA	11KV	DS DIVN. MALERKOTLA	DS S/D SHERWANKOT	0211F105	SHERGARH CHEEMA UPS	AMR	OK	31.03.2023	Category 5-UPS	2066869	900-450/577/1-1-1	11.885	NA	Director/D				
B.6714	South	BARNALA	11KV	DS DIVN. MALERKOTLA	DS S/D SHERWANKOT	0211F108	KUTHALA (MLK)	AMR	OK	31.03.2023	AP 3Phase 3Wire	8223162	1200/577/1-1-1	0.000	NA	Director/D				
B.6715	South	BARNALA	11KV	DS DIVN. MALERKOTLA	DS S/D SHERWANKOT	0211F116	KANGANWAL	AMR	OK	31.03.2023	AP 3Phase 3Wire	9168418	1200/577/1-1-1	0.183	NA	Director/D				
B.6716	South	BARNALA	11KV	DS DIVN. MALERKOTLA	DS S/D SHERWANKOT	0211F109	CHEEMA	AMR	OK	31.03.2023	AP 3Phase 3Wire	9168461	1200/577/1-1-1	2.276	NA	Director/D				
B.6717	South	BARNALA	11KV	DS DIVN. MALERKOTLA	DS S/D SHERWANKOT	0211F104	SHRI RAVIDAS NAGAR	AMR	OK	31.03.2023	Category 1	2067765	1200/577/1-1-1	2.875	NA	Director/D				
B.6718	South	BARNALA	11KV	DS DIVN. MALERKOTLA	DS S/D SHERWANKOT	0211F113	TAKHAR	AMR	OK	31.03.2023	AP 3Phase 3Wire	9168359	1200/577/1-1-1	4.896	NA	Director/D				
B.6719	South	BARNALA	11KV	DS DIVN. MALERKOTLA	DS S/D SHERWANKOT	0211F122	11 KV Baba Bule Shah	AMR	OK	31.03.2023	AP 3Phase 3Wire	4449	1200-600/5	0.272	NA	Director/D				
B.6720	South	BARNALA	11KV	DS DIVN. MALERKOTLA	DS S/D SHERWANKOT	0211F120	Barkatpura	AMR	OK	31.03.2023	AP 3Phase 3Wire	15193877	900-450/577/1-1-1	3.047	NA	Director/D				
B.6721	South	BARNALA	11KV	DS DIVN. MALERKOTLA	DS S/D SHERWANKOT	0211F107	RAJOUR	NON AMR	OK	31.03.2023	AP 3Phase 3Wire	8223171	1200-600/5	4.546	NA	Director/D				
B.6722	South	BARNALA	11KV	DS DIVN. MALERKOTLA	DS S/D SHERWANKOT	0211F119	Rskot Road Industry Cat-2	AMR	OK	31.03.2023	Category 2	7318564	900-450/577/1-1-1	6.884	NA	Director/D				
B.6723	South	BARNALA	11KV	DS DIVN. MALERKOTLA	DS S/D SHERWANKOT	0211F106	SHERWANKOT UPS	AMR	OK											

S.No	Zone	Circle	Voltage Level (kVA)	Division (kVA)	Sub-Division (kVA)	Feeder ID	Feeder Name	Feeder Metering Status (Metered/unmetered/AMR/AM)	Status of Meter (Functional/Non-functional)	Metering Date	Date of last actual meter reading/communication	Feeder Type (Agr/Industrial/Mixed)	Status of Communication			Period from 01.04.2021 to 31.03.2022				Sales	Remarks (Source of data)
													% data received through automatically if feeder AMR/AM	Number of hours when meter was unable to communicate in overall	Total Number of hours in the period	Meter S.No	CT/PT ratio	Import (kU)	Export (kU)		
B.6760	South	BARNALA	11KV	DS DIVN. MALERKOTLA	DS S/U S/D MALERKOTLA	D211FL19	INDUSTRIAL RATOLAN	NON AMR	OK	31.03.2023		Category 2				73210572	1200/577/1-1-1	9.653	NA	Director/D	
B.6761	South	BARNALA	11KV	DS DIVN. MALERKOTLA	DS S/U S/D MALERKOTLA	D202FL05	NARIKE (56 KV MANN)	Not available	OK	31.03.2023		AP 3Phase 3Wire				9154084	900-450/577/1-1-1	2.671	NA	Director/D	
B.6762	South	BARNALA	8KV	DS DIVN. MALERKOTLA	DS S/U S/D MALERKOTLA	D201DL13	Malerkotla Steel and Alloys	AMR	OK	31.03.2023		Category 3				Not available	Not available	9.038	NA	Director/D	
B.6763	South	BARNALA	11KV	DS DIVN. MALERKOTLA	DS S/U S/D MALERKOTLA	D215FL04	NARBER PAPER MILL	NON AMR	OK	31.03.2023		Category 4				91544011	1200-600/5	0.010	NA	Director/D	
B.6764	South	BARNALA	11KV	DS DIVN. MALERKOTLA	DS S/U S/D MALERKOTLA	D215FL99	SUB STATION NAUDHARANI	AMR	OK	31.03.2023		Substation Transformer				99	900-450/577/1-1-1	0.011	NA	Director/D	
B.6765	South	BARNALA	11KV	DS DIVN. MALERKOTLA	DS S/U S/D MALERKOTLA	D215FL23	SADPOUR ROAD	AMR	OK	31.03.2023		Category 2				91681172	900-450/577/1-1-1	0.164	NA	Director/D	
B.6766	South	BARNALA	11KV	DS DIVN. MALERKOTLA	DS S/U S/D MALERKOTLA	D215FL10	NAUDHARANI CAT J	AMR	OK	31.03.2023		Category 1				10288336	1200-600/5	1.085	NA	Director/D	
B.6767	South	BARNALA	11KV	DS DIVN. MALERKOTLA	DS S/U S/D MALERKOTLA	D215FL16	Focal Point Hathan	AMR	OK	31.03.2023		AP 3Phase 3Wire				2066034	1200-600/5	1.094	NA	Director/D	
B.6768	South	BARNALA	11KV	DS DIVN. MALERKOTLA	DS S/U S/D MALERKOTLA	D215FL05	BURI	AMR	OK	31.03.2023		AP 3Phase 3Wire				8223098	900-450/577/1-1-1	1.105	NA	Director/D	
B.6769	South	BARNALA	11KV	DS DIVN. MALERKOTLA	DS S/U S/D MALERKOTLA	D215FL05	SADPOUR	AMR	OK	31.03.2023		AP 3Phase 3Wire				4221194	1200-600/5	1.971	NA	Director/D	
B.6770	South	BARNALA	11KV	DS DIVN. MALERKOTLA	DS S/U S/D MALERKOTLA	D215FL13	ADAMWAL	AMR	OK	31.03.2023		AP 3Phase 3Wire				8222714	1200-600/5	2.159	NA	Director/D	
B.6771	South	BARNALA	11KV	DS DIVN. MALERKOTLA	DS S/U S/D MALERKOTLA	D215FL21	11 kv Faizgarh	NON AMR	OK	31.03.2023		AP 3Phase 3Wire				33373	900-450/577/1-1-1	1.279	NA	Director/D	
B.6772	South	BARNALA	11KV	DS DIVN. MALERKOTLA	DS S/U S/D MALERKOTLA	D215FL18	11 kv Chughan	AMR	OK	31.03.2023		AP 3Phase 3Wire				33987	900-450/577/1-1-1	2.243	NA	Director/D	
B.6773	South	BARNALA	11KV	DS DIVN. MALERKOTLA	DS S/U S/D MALERKOTLA	D215FL09	MADEVI	AMR	OK	31.03.2023		AP 3Phase 3Wire				8222712	1200-600/5	2.257	NA	Director/D	
B.6774	South	BARNALA	11KV	DS DIVN. MALERKOTLA	DS S/U S/D MALERKOTLA	D215FL08	HEMHEBI	AMR	OK	31.03.2023		AP 3Phase 3Wire				8222713	1200-600/5	2.637	NA	Director/D	
B.6775	South	BARNALA	11KV	DS DIVN. MALERKOTLA	DS S/U S/D MALERKOTLA	D215FL02	DALEGARH	AMR	OK	31.03.2023		AP 3Phase 3Wire				8222715	900-450/577/1-1-1	2.995	NA	Director/D	
B.6776	South	BARNALA	11KV	DS DIVN. MALERKOTLA	DS S/U S/D MALERKOTLA	D215FL15	himtana	AMR	OK	31.03.2023		AP 3Phase 3Wire				11052030	900-450/577/1-1-1	3.142	NA	Director/D	
B.6777	South	BARNALA	11KV	DS DIVN. MALERKOTLA	DS S/U S/D MALERKOTLA	D215FL11	VISHAL PAPER MILL	AMR	OK	31.03.2023		Category 4				5388139	1200-600/5	9.237	NA	Director/D	
B.6778	South	BARNALA	11KV	DS DIVN. MALERKOTLA	DS S/U S/D MALERKOTLA	D215FL03	HATHAN UPS	AMR	OK	31.03.2023		Category 5-UPS				6486425	900-450/577/1-1-1	9.362	NA	Director/D	
B.6779	South	BARNALA	11KV	DS DIVN. MALERKOTLA	DS S/U S/D MALERKOTLA	D215FL12	NARBER PAPER MILL	AMR	OK	31.03.2023		Category 4				2047191	1200-600/5	10.575	NA	Director/D	
B.6780	South	BARNALA	11KV	DS DIVN. MALERKOTLA	DS S/U S/D MALERKOTLA	D215FL01	Industrial	NON AMR	OK	31.03.2023		Category 2				2057490	900-450/577/1-1-1	12.637	NA	Director/D	
B.6781	South	BARNALA	11KV	DS S/U DIVN. BARNALA	DS S/D BHADOUR	D784FL99	Sub Station Talwandi	NON AMR	OK	31.03.2023		Substation Transformer				99	900-450/577/1-1-1	0.010	NA	Director/D	
B.6782	South	BARNALA	11KV	DS S/U DIVN. BARNALA	DS S/D BHADOUR	D784FL05	ALKRA	NON AMR	OK	31.03.2023		AP 3Phase 3Wire				15196056	900-450/577/1-1-1	2.492	NA	Director/D	
B.6783	South	BARNALA	11KV	DS S/U DIVN. BARNALA	DS S/D BHADOUR	D784FL02	KHARAK SINGH WALA	AMR	OK	31.03.2023		AP 3Phase 3Wire				15196063	900-450/577/1-1-1	2.520	NA	Director/D	
B.6784	South	BARNALA	11KV	DS S/U DIVN. BARNALA	DS S/D BHADOUR	D784FL04	Talwandi AP	NON AMR	OK	31.03.2023		AP 3Phase 3Wire				15194778	900-450/577/1-1-1	2.650	NA	Director/D	
B.6785	South	BARNALA	11KV	DS S/U DIVN. BARNALA	DS S/D BHADOUR	D784FL03	Bhag Ke Road	NON AMR	OK	31.03.2023		AP 3Phase 3Wire				15194757	900-450/577/1-1-1	2.718	NA	Director/D	
B.6786	South	BARNALA	11KV	DS S/U DIVN. BARNALA	DS S/D BHADOUR	D784FL01	Talwandi Cat-1	AMR	OK	31.03.2023		Category 1				15196061	900-450/577/1-1-1	3.085	NA	Director/D	
B.6787	South	BARNALA	11KV	DS S/U DIVN. BARNALA	DS S/D BHADOUR	D241FL17	CHANNA BRANCH	AMR	OK	31.03.2023		AP 3Phase 3Wire				2066462	1200/577/1-1-1	0.000	NA	Director/D	
B.6788	South	BARNALA	11KV	DS S/U DIVN. BARNALA	DS S/D BHADOUR	D241FL15	JHAIHAN WALI BR.	AMR	OK	31.03.2023		AP 3Phase 3Wire				9140897	1200/577/1-1-1	0.000	NA	Director/D	
B.6789	South	BARNALA	11KV	DS S/U DIVN. BARNALA	DS S/D BHADOUR	D241FL16	CHANNA GULAB SINGH BR.	AMR	OK	31.03.2023		AP 3Phase 3Wire				11116905	1200/577/1-1-1	0.000	NA	Director/D	
B.6790	South	BARNALA	11KV	DS S/U DIVN. BARNALA	DS S/D BHADOUR	D241FL18	MADRASSA BR.	AMR	OK	31.03.2023		AP 3Phase 3Wire				9140898	1200/577/1-1-1	0.000	NA	Director/D	
B.6791	South	BARNALA	11KV	DS S/U DIVN. BARNALA	DS S/D BHADOUR	D241FL19	JORA SINGH BR.	AMR	OK	31.03.2023		Category 5-UPS				5340260	1200/577/1-1-1	0.000	NA	Director/D	
B.6792	South	BARNALA	11KV	DS S/U DIVN. BARNALA	DS S/D BHADOUR	D241FL36	Majhu KE NEW Branch	AMR	OK	31.03.2023		AP 3Phase 3Wire				11117256	1200/577/1-1-1	0.000	NA	Director/D	
B.6793	South	BARNALA	11KV	DS S/U DIVN. BARNALA	DS S/D BHADOUR	D241FL37	Kothe Hingera De Br.	NON AMR	OK	31.03.2023		AP 3Phase 3Wire				8222947	1200/577/1-1-1	0.000	NA	Director/D	
B.6794	South	BARNALA	11KV	DS S/U DIVN. BARNALA	DS S/D BHADOUR	D241FL99	Sub Station Bhadour	NON AMR	OK	31.03.2023		Substation Transformer				99	1200/577/1-1-1	0.019	NA	Director/D	
B.6795	South	BARNALA	11KV	DS S/U DIVN. BARNALA	DS S/D BHADOUR	D241FL26	KOTHE BILAS PUR	AMR	OK	31.03.2023		AP 3Phase 3Wire				15193882	1200/577/1-1-1	0.181	NA	Director/D	
B.6796	South	BARNALA	11KV	DS S/U DIVN. BARNALA	DS S/D BHADOUR	D241FL27	JAGANA AP	AMR	OK	31.03.2023		Category 1				4024727	1200/577/1-1-1	1.002	NA	Director/D	
B.6797	South	BARNALA	11KV	DS S/U DIVN. BARNALA	DS S/D BHADOUR	D241FL20	KHARAK SINGH WALA	AMR	OK	31.03.2023		AP 3Phase 3Wire				15193802	1200/577/1-1-1	2.078	NA	Director/D	
B.6798	South	BARNALA	11KV	DS S/U DIVN. BARNALA	DS S/D BHADOUR	D241FL29	SIKHAN DE KOTHE BR.	NON AMR	OK	31.03.2023		AP 3Phase 3Wire				5643	1200/577/1-1-1	2.173	NA	Director/D	
B.6799	South	BARNALA	11KV	DS S/U DIVN. BARNALA	DS S/D BHADOUR	D241FL21	BABA BHAN SINGH	NON AMR	OK	31.03.2023		AP 3Phase 3Wire				15193838	1200/577/1-1-1	2.394	NA	Director/D	
B.6800	South	BARNALA	11KV	DS S/U DIVN. BARNALA	DS S/D BHADOUR	D241FL31	BABA MALIK SINGH	AMR	OK	31.03.2023		AP 3Phase 3Wire				15193731	1200/577/1-1-1	2.765	NA	Director/D	
B.6801	South	BARNALA	11KV	DS S/U DIVN. BARNALA	DS S/D BHADOUR	D241FL06	Sidhawalpura	AMR	OK	31.03.2023		AP 3Phase 3Wire				8223181	1200/577/1-1-1	2.937	NA	Director/D	
B.6802	South	BARNALA	11KV	DS S/U DIVN. BARNALA	DS S/D BHADOUR	D241FL12	Mulvi Gill	AMR	OK	31.03.2023		AP 3Phase 3Wire				11117255	1200/577/1-1-1	2.555	NA	Director/D	
B.6803	South	BARNALA	11KV	DS S/U DIVN. BARNALA	DS S/D BHADOUR	D241FL07	Sandhu Kalan AP	NON AMR	OK	31.03.2023		AP 3Phase 3Wire				8222947	1200/577/1-1-1	3.931	NA	Director/D	
B.6804	South	BARNALA	11KV	DS S/U DIVN. BARNALA	DS S/D BHADOUR	D241FL30	BARNALA ROAD CITY	AMR	OK	31.03.2023		Category 1				3608	1200/577/1-1-1	4.187	NA	Director/D	
B.6805	South	BARNALA	11KV	DS S/U DIVN. BARNALA	DS S/D BHADOUR	D241FL10	RAMGARH	AMR	OK	31.03.2023		AP 3Phase 3Wire				9140898	1200/577/1-1-1	4.313	NA	Director/D	
B.6806	South	BARNALA	11KV	DS S/U DIVN. BARNALA	DS S/D BHADOUR	D241FL09	Vidhata	NON AMR	OK	31.03.2023		AP 3Phase 3Wire				9140897	1200/577/1-1-1	4.322	NA	Director/D	
B.6807	South	BARNALA	11KV	DS S/U DIVN. BARNALA	DS S/D BHADOUR	D241FL22	RAMANA	AMR	OK	31.03.2023		Category 5-UPS				15193887	1200/577/1-1-1	4.428	NA	Director/D	
B.6808	South	BARNALA	11KV	DS S/U DIVN. BARNALA	DS S/D BHADOUR	D241FL03	ALKRA	AMR	OK	31.03.2023		AP 3Phase 3Wire				9140896	1200/577/1-1-1	6.880	NA	Director/D	
B.6809	South	BARNALA	11KV	DS S/U DIVN. BARNALA	DS S/D BHADOUR	D241FL01	TALWANDI	AMR	OK	31.03.2023		AP 3Phase 3Wire				2066462	1200/577/1-1-1	5.078	NA	Director/D	
B.6810	South	BARNALA	11KV	DS S/U DIVN. BARNALA	DS S/D BHADOUR	D241FL13	NAINEWAL	AMR	OK	31.03.2023		AP 3Phase 3Wire				11116905	1200/577/1-1-1	5.279	NA	Director/D	
B.6811	South	BARNALA	11KV	DS S/U DIVN. BARNALA	DS S/D BHADOUR	D241FL33	Jargana	AMR	OK	31.03.2023		Category 5-UPS				5450	1200/577/1-1-1	5.813	NA	Director/D	
B.6812	South	BARNALA	11KV	DS S/U DIVN. BARNALA	DS S/D BHADOUR	D241FL14	B.L.ROAD	AMR	OK	31.03.2023		Category 1				11116934	1200/577/1-1-1	6.227	NA	Director/D	
B.6813	South	BARNALA	11KV	DS S/U DIVN. BARNALA	DS S/D BHADOUR	D241FL11	Ramgarh UPS	AMR	OK	31.03.2023		Category 5-UPS				11117260	1200/577/1-1-1	6.313	NA	Director/D	
B.6814	South	BARNALA	11KV	DS S/U DIVN. BARNALA	DS S/D BHADOUR	D241FL02	SANDHU KALAN UPS	AMR	OK	31.03.2023		Category 5-UPS				2068077	1200/577/1-1-1	9.287	NA	Director/D	
B.6815	South	BARNALA	11KV	DS S/U DIVN. BARNALA	DS S/D BHADOUR	D241FL25	Nanak Sar Road	AMR	OK	31.03.2023		Category 1				5295560					

S.No	Zone	Circle	Voltage Level (kVA)	Division (kVA)	Sub-Division (kVA)	Feeder ID	Feeder Name	Feeder Metering Status (Metred/unmetred/AMR/AMI)	Status of Meter (Functional/Non-Functional)	Metering Date (Date of last actual meter reading/communication)	Feeder Type (Agr/Industrial/Mixed)	Status of Communication			Period from 01.04.2021 to 31.03.2022				Sales	Remarks (Source of data)
												% data received through automatically if feeder AMR/AMI	Number of hours when meter was unable to communicate in overall	Total Number of hours in the period	Meter S.No	CT/PT ratio	Import (kWh)	Export (kWh)		
B.6857	South	BARNALA	11KV	DS S/U DIVN. BARNALA	DS S/D NO-2 TAPA	D0372F05	BHANUJANA	AMR	OK	31.03.2023	AP 3Phase 3Wire				9141042	Not installed	3.272	NA	Director/D	
B.6858	South	BARNALA	11KV	DS S/U DIVN. BARNALA	DS S/D NO-2 TAPA	D0244F08	FATEHPUR PINDI BR.	AMR	OK	31.03.2023	AP 3Phase 3Wire				8223624	900-450/577/1-1	0.000	NA	Director/D	
B.6859	South	BARNALA	11KV	DS S/U DIVN. BARNALA	DS S/D NO-2 TAPA	D0244FL17	DITIANA BR.	AMR	OK	31.03.2023	AP 3Phase 3Wire				2052823	900-450/577/1-1	0.000	NA	Director/D	
B.6860	South	BARNALA	11KV	DS S/U DIVN. BARNALA	DS S/D NO-2 TAPA	D0244FL18	BARHADA SINGH WALA BR.	AMR	OK	31.03.2023	AP 3Phase 3Wire				9544707	900-450/577/1-1	0.000	NA	Director/D	
B.6861	South	BARNALA	11KV	DS S/U DIVN. BARNALA	DS S/D NO-2 TAPA	D0244FL19	HARI SINGH WALA BR.	AMR	OK	31.03.2023	AP 3Phase 3Wire				8223623	900-450/577/1-1	0.000	NA	Director/D	
B.6862	South	BARNALA	11KV	DS S/U DIVN. BARNALA	DS S/D NO-2 TAPA	D0244FL99	Sub Station Dhoula	AMR	OK	31.03.2023	Substation Transformer				99	900-450/577/1-1	0.014	NA	Director/D	
B.6863	South	BARNALA	11KV	DS S/U DIVN. BARNALA	DS S/D NO-2 TAPA	D0244FL27	IOI-B	AMR	OK	31.03.2023	Category 4				5593	900-450/577/1-1	1.922	NA	Director/D	
B.6864	South	BARNALA	11KV	DS S/U DIVN. BARNALA	DS S/D NO-2 TAPA	D0244FL12	KIPRAL SINGH WALA	AMR	OK	31.03.2023	AP 3Phase 3Wire				8223624	900-450/577/1-1	3.031	NA	Director/D	
B.6865	South	BARNALA	11KV	DS S/U DIVN. BARNALA	DS S/D NO-2 TAPA	D0244FL20	Panchayati Tak	AMR	OK	31.03.2023	AP 3Phase 3Wire				4297	900-450/577/1-1	3.845	NA	Director/D	
B.6866	South	BARNALA	11KV	DS S/U DIVN. BARNALA	DS S/D NO-2 TAPA	D0244FL25	IOI	AMR	OK	31.03.2023	Category 4				923	900-450/577/1-1	4.020	NA	Director/D	
B.6867	South	BARNALA	11KV	DS S/U DIVN. BARNALA	DS S/D NO-2 TAPA	D0244FL07	Arisar	AMR	OK	31.03.2023	AP 3Phase 3Wire				9534570	900-450/577/1-1	4.026	NA	Director/D	
B.6868	South	BARNALA	11KV	DS S/U DIVN. BARNALA	DS S/D NO-2 TAPA	D0244FL15	Kaneke	AMR	OK	31.03.2023	AP 3Phase 3Wire				9140900	900-450/577/1-1	4.926	NA	Director/D	
B.6869	South	BARNALA	11KV	DS S/U DIVN. BARNALA	DS S/D NO-2 TAPA	D0244F05	RUREKE KALAN	AMR	OK	31.03.2023	AP 3Phase 3Wire				8223623	900-450/577/1-1	5.232	NA	Director/D	
B.6870	South	BARNALA	11KV	DS S/U DIVN. BARNALA	DS S/D NO-2 TAPA	D0244FL04	DHOOROOT	AMR	OK	31.03.2023	AP 3Phase 3Wire				9544707	900-450/577/1-1	5.523	NA	Director/D	
B.6871	South	BARNALA	11KV	DS S/U DIVN. BARNALA	DS S/D NO-2 TAPA	D0244FL01	DHAULA RURAL	AMR	OK	31.03.2023	AP 3Phase 3Wire				8223625	900-450/577/1-1	6.702	NA	Director/D	
B.6872	South	BARNALA	11KV	DS S/U DIVN. BARNALA	DS S/D NO-2 TAPA	D0244FL02	DHAULA UPS	NON AMR	OK	31.03.2023	Category 5-UPS				6486418	900-450/577/1-1	14.404	NA	Director/D	
B.6873	South	BARNALA	11KV	DS S/U DIVN. BARNALA	DS S/D NO-2 TAPA	D0244FL10	RUREKE KALAN UPS	Not available	OK	31.03.2023	Category 5-UPS				11117292	900-450/577/1-1	19.852	NA	Director/D	
B.6874	South	BARNALA	66KV	DS S/U DIVN. BARNALA	DS S/D NO-2 TAPA	B005C18	Abhishek ind. Dhauila	AMR	OK	31.03.2023	Category 4				Not available	Not available	26.062	NA	Director/D	
B.6875	South	BARNALA	11KV	DS S/U DIVN. BARNALA	DS S/D NO-2 TAPA	D0244FL18	JIOND BR.	AMR	OK	31.03.2023	AP 3Phase 3Wire				1247957	1200/577/1-1	0.000	NA	Director/D	
B.6876	South	BARNALA	11KV	DS S/U DIVN. BARNALA	DS S/D NO-2 TAPA	D0244FL19	GHEELLA BR.	AMR	OK	31.03.2023	AP 3Phase 3Wire				9168848	1200/577/1-1	0.000	NA	Director/D	
B.6877	South	BARNALA	11KV	DS S/U DIVN. BARNALA	DS S/D NO-2 TAPA	D0244FL24	CHEMAL SINGH WALA	AMR	OK	31.03.2023	AP 3Phase 3Wire				15194720	1200/577/1-1	1.647	NA	Director/D	
B.6878	South	BARNALA	11KV	DS S/U DIVN. BARNALA	DS S/D NO-2 TAPA	D0243F07	MEHTA	AMR	OK	31.03.2023	AP 3Phase 3Wire				24319	1200/577/1-1	2.618	NA	Director/D	
B.6879	South	BARNALA	11KV	DS S/U DIVN. BARNALA	DS S/D NO-2 TAPA	D0243FL22	Nand Singh Wala Br.	AMR	OK	31.03.2023	AP 3Phase 3Wire				24369	1200/577/1-1	3.451	NA	Director/D	
B.6880	South	BARNALA	11KV	DS S/U DIVN. BARNALA	DS S/D NO-2 TAPA	D0243F05	GHARALI	AMR	OK	31.03.2023	AP 3Phase 3Wire				1247957	1200/577/1-1	5.549	NA	Director/D	
B.6881	South	BARNALA	11KV	DS S/U DIVN. BARNALA	DS S/D NO-2 TAPA	D0243F06	TAJO KE	AMR	OK	31.03.2023	AP 3Phase 3Wire				9140848	1200/577/1-1	5.862	NA	Director/D	
B.6882	South	BARNALA	11KV	DS S/U DIVN. BARNALA	DS S/D NO-2 TAPA	D0243FL10	BAHALA UPS	NON AMR	OK	31.03.2023	Category 5-UPS				8223139	1200/577/1-1	10.862	NA	Director/D	
B.6883	South	BARNALA	11KV	DS S/U DIVN. BARNALA	DS S/D SEHNA	D0243FL99	Sub Station Cheema	AMR	OK	31.03.2023	Substation Transformer				99	900-450/577/1-1	0.002	NA	Director/D	
B.6884	South	BARNALA	11KV	DS S/U DIVN. BARNALA	DS S/D SEHNA	D0243FL04	PATTI SEKHWAN	NON AMR	OK	31.03.2023	AP 3Phase 3Wire				23513	900-450/577/1-1	2.229	NA	Director/D	
B.6885	South	BARNALA	11KV	DS S/U DIVN. BARNALA	DS S/D SEHNA	D0243FL03	JAWANDHA KOTHE	NON AMR	OK	31.03.2023	AP 3Phase 3Wire				23584	900-450/577/1-1	2.259	NA	Director/D	
B.6886	South	BARNALA	11KV	DS S/U DIVN. BARNALA	DS S/D SEHNA	D0243FL06	Kutiya	NON AMR	OK	31.03.2023	AP 3Phase 3Wire				5585	900-450/577/1-1	2.274	NA	Director/D	
B.6887	South	BARNALA	11KV	DS S/U DIVN. BARNALA	DS S/D SEHNA	D0243FL05	LODPHUR	NON AMR	OK	31.03.2023	AP 3Phase 3Wire				23525	900-450/577/1-1	2.991	NA	Director/D	
B.6888	South	BARNALA	11KV	DS S/U DIVN. BARNALA	DS S/D SEHNA	D0243FL07	NAWAHA AP	NON AMR	OK	31.03.2023	AP 3Phase 3Wire				245437	900-450/577/1-1	3.208	NA	Director/D	
B.6889	South	BARNALA	11KV	DS S/U DIVN. BARNALA	DS S/D SEHNA	D0243FL02	NAWAHA UPS	NON AMR	OK	31.03.2023	Category 5-UPS				23545	900-450/577/1-1	8.245	NA	Director/D	
B.6890	South	BARNALA	11KV	DS S/U DIVN. BARNALA	DS S/D SEHNA	D0243FL01	CHEEMA	NON AMR	OK	31.03.2023	Category 1				23720	900-450/577/1-1	8.357	NA	Director/D	
B.6891	South	BARNALA	11KV	DS S/U DIVN. BARNALA	DS S/D SEHNA	D0243FL23	NELLO BR.	AMR	OK	31.03.2023	AP 3Phase 3Wire				15193882	1200/577/1-1	0.000	NA	Director/D	
B.6892	South	BARNALA	11KV	DS S/U DIVN. BARNALA	DS S/D SEHNA	D0243FL04	SEHNA HUB	AMR	OK	31.03.2023	AP 3Phase 3Wire				7336353	1200/577/1-1	3.350	NA	Director/D	
B.6893	South	BARNALA	11KV	DS S/U DIVN. BARNALA	DS S/D SEHNA	D0243FL05	SEKH SINGH WALA	AMR	OK	31.03.2023	AP 3Phase 3Wire				5362503	1200/577/1-1	3.451	NA	Director/D	
B.6894	South	BARNALA	11KV	DS S/U DIVN. BARNALA	DS S/D SEHNA	D0243FL02	Jodhpur II	AMR	OK	31.03.2023	AP 3Phase 3Wire				2066402	900-450/577/1-1	0.000	NA	Director/D	
B.6895	South	BARNALA	11KV	DS S/U DIVN. BARNALA	DS S/D SEHNA	D0243FL14	BAKHTGARH II	AMR	OK	31.03.2023	AP 3Phase 3Wire				8223730	1200/577/1-1	0.000	NA	Director/D	
B.6896	South	BARNALA	11KV	DS S/U DIVN. BARNALA	DS S/D SEHNA	D0243FL15	SOLAN DA MATH BR.	AMR	OK	31.03.2023	AP 3Phase 3Wire				8223726	1200/577/1-1	0.000	NA	Director/D	
B.6897	South	BARNALA	11KV	DS S/U DIVN. BARNALA	DS S/D SEHNA	D0243FL16	KAIRE ROAD BR.	NON AMR	OK	31.03.2023	AP 3Phase 3Wire				2066284	900-450/577/1-1	0.000	NA	Director/D	
B.6898	South	BARNALA	11KV	DS S/U DIVN. BARNALA	DS S/D SEHNA	D0243FL99	Sub Station Pakho	AMR	OK	31.03.2023	Substation Transformer				99	900-450/577/1-1	0.012	NA	Director/D	
B.6899	South	BARNALA	11KV	DS S/U DIVN. BARNALA	DS S/D SEHNA	D0243FL19	PATTI SEKHWAN	AMR	OK	31.03.2023	AP 3Phase 3Wire				10288393	900-450/577/1-1	0.021	NA	Director/D	
B.6900	South	BARNALA	11KV	DS S/U DIVN. BARNALA	DS S/D SEHNA	D0243FL18	GILL KOTHE	AMR	OK	31.03.2023	AP 3Phase 3Wire				16199304	1200/577/1-1	2.496	NA	Director/D	
B.6901	South	BARNALA	11KV	DS S/U DIVN. BARNALA	DS S/D SEHNA	D0243FL13	SURKHUA	AMR	OK	31.03.2023	AP 3Phase 3Wire				16199382	1200/577/1-1	2.591	NA	Director/D	
B.6902	South	BARNALA	11KV	DS S/U DIVN. BARNALA	DS S/D SEHNA	D0243FL10	PAKHOKE CAT-1	AMR	OK	31.03.2023	Category 1				206568	900-450/577/1-1	2.646	NA	Director/D	
B.6903	South	BARNALA	11KV	DS S/U DIVN. BARNALA	DS S/D SEHNA	D0243FL20	NAWAHA NEW	AMR	OK	31.03.2023	AP 3Phase 3Wire				11117184	1200/577/1-1	2.716	NA	Director/D	
B.6904	South	BARNALA	11KV	DS S/U DIVN. BARNALA	DS S/D SEHNA	D0243FL12	PAKHO	AMR	OK	31.03.2023	AP 3Phase 3Wire				8223726	1200/577/1-1	2.822	NA	Director/D	
B.6905	South	BARNALA	11KV	DS S/U DIVN. BARNALA	DS S/D SEHNA	D0243FL01	Jodhpur-1+MALHAN	NON AMR	OK	31.03.2023	AP 3Phase 3Wire				8223726	1200/577/1-1	2.844	NA	Director/D	
B.6906	South	BARNALA	11KV	DS S/U DIVN. BARNALA	DS S/D SEHNA	D0243FL11	MALLIAN	AMR	OK	31.03.2023	AP 3Phase 3Wire				11117222	1200/577/1-1	3.301	NA	Director/D	
B.6907	South	BARNALA	11KV	DS S/U DIVN. BARNALA	DS S/D SEHNA	D0243FL03	CHEEMA	AMR	OK	31.03.2023	AP 3Phase 3Wire				2068843	900-450/577/1-1	3.931	NA	Director/D	
B.6908	South	BARNALA	11KV	DS S/U DIVN. BARNALA	DS S/D SEHNA	D0243FL06	NAWAHA	AMR	OK	31.03.2023	AP 3Phase 3Wire				2066284	900-450/577/1-1	4.930	NA	Director/D	
B.6909	South	BARNALA	11KV	DS S/U DIVN. BARNALA	DS S/D SEHNA	D0243FL09	UCKOT	AMR	OK	31.03.2023	AP 3Phase 3Wire				2068402	900-450/577/1-1	5.499	NA	Director/D	
B.6910	South	BARNALA	11KV	DS S/U DIVN. BARNALA	DS S/D SEHNA	D0243FL08	BAKHTGARH	AMR	OK	31.03.2023	AP 3Phase 3Wire				8223730	1200/577/1-1	6.040	NA	Director/D	
B.6911	South	BARNALA	11KV	DS S/U DIVN. BARNALA	DS S/D SEHNA	D0243FL08	BETHLA 24 Hrs.	AMR	OK	31.03.2023	Category 5-UPS				2066924	1200/577/1-1	6.347	NA	Director/D	
B.6912	South	BARNALA	11KV	DS S/U DIVN. BARNALA	DS S/D SEHNA	D0243FL05	SEHNA 24 Hrs.	NON AMR	OK	31.03.2023	Category 5-UPS				10288393	900-450/577/1-1	7.750	NA	Director/D	
B.6913	South	BARNALA	11KV	DS S/U DIVN. BARNALA	DS S/D SEHNA	TB01FL99	Sub Station Sehna	NON AMR	OK	31.03.2023	Substation Transformer				99	1200/577/1-1	0.014	NA	Director/D	
B.6914	South	BARNALA	11KV	DS S/U DIVN. BARNALA	DS S/D SEHNA	TB01FL02	BHADOUR ROAD	AMR	OK	31.03.2023	AP 3Phase 3Wire				23799	1200/577/1-1	2.052	NA	Director/D	
B.6915	South	BARNALA	11KV	DS S/U DIVN. BARNALA	DS S/D SEHNA	TB01FL21	Nawaha	AMR	OK	31.03.2023	AP 3Phase 3Wire				3163958	1200/577/1-1	3.065	NA	Director/D	
B.6916	South	BARNALA	11KV	DS S/U DIVN. BARNALA	DS S/D SEHNA	TB01FL11	Nehoi Brenchan	NON AMR	OK	31.03.2023	AP 3Phase 3Wire				4825	1200/577/1-1	3.471	NA	Director/D	
B.6917	South	BARNALA	11KV	DS S/U DIVN. BARNALA	DS S/D SEHNA	TB01FL03	BURAI ROAD	NON AMR	OK	31.03.2023	AP 3Phase 3Wire				23574	1200/577/1-1	3.697	NA	Director/D	
B.6918	South	BARNALA	11KV	DS S/U DIVN. BARNALA	DS S/D SEHNA	TB01FL05	PAKHO KE	NON AMR	OK	31.03.2023	AP 3Phase 3Wire				24352	1200/577/1-1	3.886	NA	Director/D	
B.6919	South	BARNALA	11KV	DS S/U DIVN. BARNALA	DS S/D SEHNA	TB01FL01	SEHNA cat-1	AMR	OK	31.03.2023	Category 1				23707	1200/577/1-1	19.305	NA	Director/D	
B.6920	South	BARNALA	11KV	DS S/U DIVN. BARNALA	DS S/D SEHNA	X204FL12	KOTHE SHEMBER BR.	AMR	OK	31.03.2023	AP 3Phase 3Wire				579609	900-450/577/1-1	0.000	NA	Director/D	
B.6921	South	BARNALA																		

S.No	Zone	Circle	Voltage Level (kVA)	Division (kVA)	Sub-Division (kVA)	Feeder ID	Feeder Name	Feeder Metering Status (Metered/unmetered/AMR/AMI)	Status of Meter (Functional/Non-Functional)	Metering Date (Date of last actual meter reading/communication)	Feeder Type (Agr/Industrial/Mixed)	Status of Communication			Period from 01.04.2021 to 31.03.2022				Sales	Remarks (Source of data)
												% data received through automatically if feeder AMR/AMI	Number of hours when meter was unable to communicate in overall	Total Number of hours in the period	Meter S.No	CT/PT ratio	Import (kWh)	Export (kWh)		
B.6954	South	BARNALA	11KV	DS S/U DIVN. BARNALA	DS S/U S/D BARNALA	B205FL14	KHULDI KALAN	AMR	OK	31.03.2023	AP 3Phase 3Wire				822784	1200/577/1-1-1	3.688	NA	Director/D	
B.6955	South	BARNALA	11KV	DS S/U DIVN. BARNALA	DS S/U S/D BARNALA	B205FL13	Sukhpura	NON AMR	OK	31.03.2023	AP 3Phase 3Wire				9154035	1200/577/1-1-1	4.030	NA	Director/D	
B.6956	South	BARNALA	11KV	DS S/U DIVN. BARNALA	DS S/U S/D BARNALA	B205FL07	CHUNGAN	AMR	OK	31.03.2023	AP 3Phase 3Wire				1028281	1200/577/1-1-1	4.253	NA	Director/D	
B.6957	South	BARNALA	11KV	DS S/U DIVN. BARNALA	DS S/U S/D BARNALA	B205FL08	BARNALA ROAD	AMR	OK	31.03.2023	AP 3Phase 3Wire				1028309	1200/577/1-1-1	4.707	NA	Director/D	
B.6958	South	BARNALA	11KV	DS S/U DIVN. BARNALA	DS S/U S/D BARNALA	B205FL09	GETTA THREADS	AMR	OK	31.03.2023	Category 4				2065488	1200/577/1-1-1	6.748	NA	Director/D	
B.6959	South	BARNALA	11KV	DS S/U DIVN. BARNALA	DS S/U S/D BARNALA	B205FL15	Mansa Road	NON AMR	OK	31.03.2023	Category 1				6675940	1200/577/1-1-1	11.363	NA	Director/D	
B.6960	South	BARNALA	11KV	DS S/U DIVN. BARNALA	DS S/U S/D BARNALA	B205FL02	PHARWAHI 24 Hrs.	AMR	OK	31.03.2023	Category 5-U/PS				10282776	1200/577/1-1-1	13.812	NA	Director/D	
B.6961	South	BARNALA	11KV	DS S/U DIVN. BARNALA	DS S/U S/D BARNALA	B205FL01	HANDIYARA URBAN	AMR	OK	31.03.2023	Category 1				9534375	1200/577/1-1-1	13.846	NA	Director/D	
B.6962	South	BARNALA	11KV	DS S/U DIVN. BARNALA	DS S/U S/D BARNALA	B205FL04	PHARWAHI RURAL	NON AMR	OK	31.03.2023	Category 1				6740710	1200/577/1-1-1	14.842	NA	Director/D	
B.6963	South	BARNALA	11KV	DS S/U DIVN. BARNALA	DS S/U S/D BARNALA	B205FL08	KOTHE THAKER SINGH	AMR	OK	31.03.2023	AP 3Phase 3Wire				73142383	900-450/577/1-1-1	2.749	NA	Director/D	
B.6964	South	BARNALA	11KV	DS S/U DIVN. BARNALA	DS S/U S/D BARNALA	B205FL15	COURT COMPLEX	AMR	OK	31.03.2023	Category 1				33408	1200/577/1-1-1	0.380	NA	Director/D	
B.6965	South	BARNALA	11KV	DS S/U DIVN. BARNALA	DS S/U S/D BARNALA	B205FL03	SURIEETPURA	AMR	OK	31.03.2023	AP 3Phase 3Wire				2068300	1200/577/1-1-1	3.503	NA	Director/D	
B.6966	South	BARNALA	11KV	DS S/U DIVN. BARNALA	DS S/U S/D BARNALA	B205FL11	PHARWAHI ROAD	AMR	OK	31.03.2023	Category 1				7042826	1200/577/1-1-1	4.769	NA	Director/D	
B.6967	South	BARNALA	11KV	DS S/U DIVN. BARNALA	DS S/U S/D BARNALA	B205FL18	LUCKY COLONY	AMR	OK	31.03.2023	Category 1				579610	900-450/577/1-1-1	10.064	NA	Director/D	
B.6968	South	BARNALA	11KV	DS S/U DIVN. BARNALA	DS S/U S/D BARNALA	B205FL04	COURT ROAD	AMR	OK	31.03.2023	Category 1				2068306	1200/577/1-1-1	12.847	NA	Director/D	
B.6969	South	BARNALA	11KV	DS S/U DIVN. BARNALA	DS S/U S/D BARNALA	B205FL08	Bajkhanha Road	AMR	OK	31.03.2023	Category 1				7030191	1200/577/1-1-1	15.897	NA	Director/D	
B.6970	South	BARNALA	11KV	DS S/U DIVN. BARNALA	DS S/U S/D BARNALA	B205FL32	Baba Thaman Dass	AMR	OK	31.03.2023	AP 3Phase 3Wire				5438	1200/577/1-1-1	4.105	NA	Director/D	
B.6971	South	BARNALA	11KV	DS S/U DIVN. BARNALA	DS S/U S/D BARNALA	B205FL04	RAIGARH/KALEKE	AMR	OK	31.03.2023	AP 3Phase 3Wire				12093578	1200/577/1-1-1	4.142	NA	Director/D	
B.6972	South	BARNALA	11KV	DS S/U DIVN. BARNALA	DS S/U S/D BARNALA	B205FL06	BARAN PUL	AMR	OK	31.03.2023	AP 3Phase 3Wire				8223854	900-450/577/1-1-1	5.780	NA	Director/D	
B.6973	South	BARNALA	11KV	DS S/U DIVN. BARNALA	DS S/U S/D BARNALA	B205FL04	Pharwahi rural	AMR	OK	31.03.2023	Category 1				5160938	900-450/577/1-1-1	3.170	NA	Director/D	
B.6974	South	BARNALA	11KV	DS S/U DIVN. BARNALA	DS S/U S/D BARNALA	B205FL10	SUKHPURA RURAL	AMR	OK	31.03.2023	AP 3Phase 3Wire				8223182	1200/577/1-1-1	3.384	NA	Director/D	
B.6975	South	BARNALA	11KV	DS S/U DIVN. BARNALA	DS S/U S/D BARNALA	B205FL25	PATTI ROAD BR.	AMR	OK	31.03.2023	AP 3Phase 3Wire				8222779	900-450/577/1-1-1	0.000	NA	Director/D	
B.6976	South	BARNALA	11KV	DS S/U DIVN. BARNALA	DS S/U S/D BARNALA	B205FL26	NAYI WALA BR.	AMR	OK	31.03.2023	AP 3Phase 3Wire				8222582	900-450/577/1-1-1	0.000	NA	Director/D	
B.6977	South	MOHALI	11KV	DS DIVN. LALRU	DS S/D HANDESRA	B309FL11	11 KV NAGLA KANDI PURE AP	AMR	OK	31.03.2023	AP 3Phase 3Wire				15194860	900-450/577/1-1-1	2.422	NA	Director/D	
B.6978	South	MOHALI	11KV	DS DIVN. LALRU	DS S/D HANDESRA	B309FL12	11 KV HAMAYUPUR KANDI PURE AP	AMR	OK	31.03.2023	AP 3Phase 3Wire				37112	900-450/577/1-1-1	3.569	NA	Director/D	
B.6979	South	MOHALI	11KV	DS DIVN. LALRU	DS S/D HANDESRA	B309FL06	Stone Cushter Handesra	AMR	OK	31.03.2023	Category 2				123456	900-450/577/1-1-1	5.378	NA	Director/D	
B.6980	South	MOHALI	11KV	DS DIVN. LALRU	DS S/D HANDESRA	B309FL03	KHELAN	AMR	OK	31.03.2023	Kandi Mixed				7338840	1200-600/5	6.557	NA	Director/D	
B.6981	South	MOHALI	11KV	DS DIVN. LALRU	DS S/D HANDESRA	B309FL02	RANI MAJRA	NON AMR	OK	31.03.2023	Kandi Mixed				6679886	900-450/577/1-1-1	6.595	NA	Director/D	
B.6982	South	MOHALI	11KV	DS DIVN. LALRU	DS S/D HANDESRA	B309FL09	HANDESRA U/PS	AMR	OK	31.03.2023	Category 5-U/PS				123456	900-450/577/1-1-1	7.084	NA	Director/D	
B.6983	South	MOHALI	11KV	DS DIVN. LALRU	DS S/D HANDESRA	B309FL05	11KV MAHLAN	AMR	OK	31.03.2023	Kandi Mixed				2068141	1200-600/5	8.003	NA	Director/D	
B.6984	South	MOHALI	11KV	DS DIVN. LALRU	DS S/D HANDESRA	B309FL04	INDUSTRIA	AMR	OK	31.03.2023	Category 2				6679886	1200-600/5	8.645	NA	Director/D	
B.6985	South	MOHALI	11KV	DS DIVN. LALRU	DS S/D HANDESRA	B309FL10	Adderwood feeder	AMR	OK	31.03.2023	Category 5 U/PS				7033078	1200-600/5	17.175	NA	Director/D	
B.6986	South	MOHALI	11KV	DS DIVN. LALRU	DS S/D HANDESRA	B316FL08	11KV Necter Life	AMR	OK	31.03.2023	Category 2				12092463	1200-600/5	1.683	NA	Director/D	
B.6987	South	MOHALI	11KV	DS DIVN. LALRU	DS S/D HANDESRA	B316FL03	DHIRE MAJRA	AMR	OK	31.03.2023	Kandi Mixed				12092488	1200-600/5	3.637	NA	Director/D	
B.6988	South	MOHALI	11KV	DS DIVN. LALRU	DS S/D HANDESRA	B316FL05	JANDLI	AMR	OK	31.03.2023	Kandi Mixed				6607348	1200-600/5	6.039	NA	Director/D	
B.6989	South	MOHALI	11KV	DS DIVN. LALRU	DS S/D HANDESRA	B316FL01	JOLLA KHRID	AMR	OK	31.03.2023	Kandi Mixed				2068662	1200-600/5	6.134	NA	Director/D	
B.6990	South	MOHALI	11KV	DS DIVN. LALRU	DS S/D HANDESRA	B316FL02	BARTANA	AMR	OK	31.03.2023	Kandi Mixed				6607249	1200-600/5	6.130	NA	Director/D	
B.6991	South	MOHALI	11KV	DS DIVN. LALRU	DS S/D HANDESRA	B316FL04	BASOLI	AMR	OK	31.03.2023	Kandi Mixed				2067748	1200-600/5	6.907	NA	Director/D	
B.6992	South	MOHALI	11KV	DS DIVN. LALRU	DS S/D HANDESRA	B316FL06	JOLLA INDUSTRIAL	AMR	OK	31.03.2023	Category 2				6675534	1200-600/5	18.754	NA	Director/D	
B.6993	South	MOHALI	11KV	DS DIVN. LALRU	DS S/D HANDESRA	B307FL08	JEOLY	Not available	OK	31.03.2023	Kandi Mixed				6607255	1200-600/5	6.427	NA	Director/D	
B.6994	South	MOHALI	66KV	DS DIVN. LALRU	DS S/D HANDESRA	B309FL08	66 KV Pragat Papers	Not available	OK	31.03.2023	Category 4				Not available	Not available	4.365	NA	Director/D	
B.6995	South	MOHALI	66KV	DS DIVN. LALRU	DS S/D HANDESRA	B316DL01	AKULM LIFESCENCE	NON AMR	OK	31.03.2023	Category 4				Not available	Not available	9.000	NA	Director/D	
B.6996	South	MOHALI	11KV	DS DIVN. LALRU	DS S/D HANDESRA	B316FL06	KHUKHUR	NON AMR	OK	31.03.2023	Kandi Mixed				236480	1200-600/5	1.348	NA	Director/D	
B.6997	South	MOHALI	11KV	DS DIVN. LALRU	DS S/D LALRU	B325FL07	11 kv Bijapur	AMR	OK	31.03.2023	Kandi Mixed				12345	1200/577/1-1-1	9.875	NA	Director/D	
B.6998	South	MOHALI	11KV	DS DIVN. LALRU	DS S/D LALRU	B316FL09	11 KV Sub-station Jaula	AMR	OK	31.03.2023	Category 1				12345	1200-600/5	0.000	NA	Director/D	
B.6999	South	MOHALI	11KV	DS DIVN. LALRU	DS S/D LALRU	B316FL12	malakpur kandi pure ap	AMR	OK	31.03.2023	Kandi Pure AP				2067928	1200-600/5	4.998	NA	Director/D	
B.7000	South	MOHALI	11KV	DS DIVN. LALRU	DS S/D LALRU	B316FL10	Ballapur UPS	AMR	OK	31.03.2023	Category 5-U/PS				6607348	1200-600/5	5.717	NA	Director/D	
B.7001	South	MOHALI	11KV	DS DIVN. LALRU	DS S/D LALRU	B309FL06	11 SPINNER	AMR	OK	31.03.2023	Category 4				6606424	1200-600/5	0.000	NA	Director/D	
B.7002	South	MOHALI	11KV	DS DIVN. LALRU	DS S/D LALRU	B308FL07	GATES INDIA	AMR	OK	31.03.2023	Category 4				9154366	1200-600/5	10.000	NA	Director/D	
B.7003	South	MOHALI	11KV	DS DIVN. LALRU	DS S/D LALRU	B308FL02	JHARNARI	AMR	OK	31.03.2023	Kandi Mixed				7336526	1200-600/5	1.454	NA	Director/D	
B.7004	South	MOHALI	11KV	DS DIVN. LALRU	DS S/D LALRU	B308FL17	Sarsini Kandi Pure AP	AMR	OK	31.03.2023	AP 3Phase 3Wire				15199036	1200-600/5	1.877	NA	Director/D	
B.7005	South	MOHALI	11KV	DS DIVN. LALRU	DS S/D LALRU	B308FL10	DHARMGARH	AMR	OK	31.03.2023	Kandi Mixed				2067092	1200-600/5	2.145	NA	Director/D	
B.7006	South	MOHALI	11KV	DS DIVN. LALRU	DS S/D LALRU	B308FL09	DHARMGARH	AMR	OK	31.03.2023	Category 1				1114465	1200-600/5	3.019	NA	Director/D	
B.7007	South	MOHALI	11KV	DS DIVN. LALRU	DS S/D LALRU	B308FL16	TIYANA U/PS	AMR	OK	31.03.2023	Category 5 U/PS				44486	1200-600/5	4.561	NA	Director/D	
B.7008	South	MOHALI	11KV	DS DIVN. LALRU	DS S/D LALRU	B308FL05	INDUSTRIAL ALAMGIR	AMR	OK	31.03.2023	Category 2				7336854	1200-600/5	5.057	NA	Director/D	
B.7009	South	MOHALI	11KV	DS DIVN. LALRU	DS S/D LALRU	B308FL01	KASALI	AMR	OK	31.03.2023	Kandi Mixed				2067021	1200-600/5	5.547	NA	Director/D	
B.7010	South	MOHALI	11KV	DS DIVN. LALRU	DS S/D LALRU	B308FL10	Nautricia International	AMR	OK	31.03.2023	Category 2				9154366	1200-600/5	6.752	NA	Director/D	
B.7011	South	MOHALI	11KV	DS DIVN. LALRU	DS S/D LALRU	B308FL03	WOCKHARD	AMR	OK	31.03.2023	Category 2				2067573	1200-600/5	7.825	NA	Director/D	
B.7012	South	MOHALI	11KV																	

S.No	Zone	Circle	Voltage Level (kVA)	Division (kVA)	Sub-Division (kVA)	Feeder ID	Feeder Name	Feeder Metering Status (Metered/unmetered/AMR/AMI)	Status of Meter (Functional/Non-functional)	Metering Date	Date of last actual meter reading/communication	Feeder Type (Agri./Industrial/Mixed)	Status of Communication			Period from 01.04.2021 to 31.03.2022				Sales	Remarks (Source of data)
													% data received through automatically if feeder AMR/AMI	Number of hours when meter was unable to communicate in overall	Total Number of hours in the period	Meter S.No	CT/PT ratio	Import (kWh)	Export (kWh)		
B.7051	South	MOHALI	11kV	DS DIVN. LALRU	DS S/D Mubarkpur	0306FL21	11 kv SUB STATION	NON AMR	OK	31.03.2023		Category 1				2066493	1200-600/5	0.000		NA	Director/D
B.7052	South	MOHALI	11kV	DS DIVN. LALRU	DS S/D Mubarkpur	0306FL32	RAMGARH ROAD	NON AMR	OK	31.03.2023		Category 2				2345	1200-600/5	0.002		NA	Director/D
B.7053	South	MOHALI	11kV	DS DIVN. LALRU	DS S/D Mubarkpur	0306FL31	MORTHIRI INDUSTRIAL	AMR	OK	31.03.2023		Category 2				2345	1200-600/5	0.333		NA	Director/D
B.7054	South	MOHALI	11kV	DS DIVN. LALRU	DS S/D Mubarkpur	0306FL23	Jaha Auto cast II	AMR	OK	31.03.2023		Category 2				12345	1200-600/5	0.775		NA	Director/D
B.7055	South	MOHALI	11kV	DS DIVN. LALRU	DS S/D Mubarkpur	0306FL08	HABIB PUR RURAL	AMR	OK	31.03.2023		Kandi Mixed				1234	1800-900	3.536		NA	Director/D
B.7056	South	MOHALI	11kV	DS DIVN. LALRU	DS S/D Mubarkpur	0306FL25	NIMBLIA	AMR	OK	31.03.2023		Category 5-UPS				4487	1200-600/5	5.820		NA	Director/D
B.7057	South	MOHALI	11kV	DS DIVN. LALRU	DS S/D Mubarkpur	0306FL26	Baull Sahib	AMR	OK	31.03.2023		Category 1				1234	1800-900	6.346		NA	Director/D
B.7058	South	MOHALI	11kV	DS DIVN. LALRU	DS S/D Mubarkpur	0306FL14	DERA BASSI INDUSTRIAL	AMR	OK	31.03.2023		Category 2				2066799	1200-600/5	8.711		NA	Director/D
B.7059	South	MOHALI	11kV	DS DIVN. LALRU	DS S/D Mubarkpur	0306FL03	Silver City	NON AMR	OK	31.03.2023		Category 1				2066493	1200-600/5	10.178		NA	Director/D
B.7060	South	MOHALI	11kV	DS DIVN. LALRU	DS S/D Mubarkpur	0306FL23	SB	NON AMR	OK	31.03.2023		Category 1				123456	1200-600/5	10.337		NA	Director/D
B.7061	South	MOHALI	11kV	DS DIVN. LALRU	DS S/D Mubarkpur	0306FL13	NIBBER CASTING	AMR	OK	31.03.2023		Category 1				1234	1200-600/5	11.532		NA	Director/D
B.7062	South	MOHALI	11kV	DS DIVN. LALRU	DS S/D Mubarkpur	0306FL27	BHANKHERPUR	AMR	OK	31.03.2023		Category 1				7039570	1200-600/5	11.770		NA	Director/D
B.7063	South	MOHALI	11kV	DS DIVN. LALRU	DS S/D Mubarkpur	0306FL07	CEPHAM	NON AMR	OK	31.03.2023		Category 4				1234	1800-900	11.969		NA	Director/D
B.7064	South	MOHALI	11kV	DS DIVN. LALRU	DS S/D Mubarkpur	0306FL01	MOHAN FIBRE	AMR	OK	31.03.2023		Category 4				12345	1800-900	11.994		NA	Director/D
B.7065	South	MOHALI	11kV	DS DIVN. LALRU	DS S/D Mubarkpur	0306FL16	HABIB PUR INDUSTRY	AMR	OK	31.03.2023		Category 2				268679	1200-600/5	12.103		NA	Director/D
B.7066	South	MOHALI	11kV	DS DIVN. LALRU	DS S/D Mubarkpur	0306FL06	FOCAL POINT DERA BASSI	AMR	OK	31.03.2023		Category 2				268679	1200-600/5	13.881		NA	Director/D
B.7067	South	MOHALI	11kV	DS DIVN. LALRU	DS S/D Mubarkpur	0306FL02	USHA AUTO CAST	AMR	OK	31.03.2023		Category 2				2994122	1200-600/5	14.550		NA	Director/D
B.7068	South	MOHALI	11kV	DS DIVN. LALRU	DS S/D Mubarkpur	0306FL09	MOHAN MEAKIN	AMR	OK	31.03.2023		Category 4				1234	1800-900	14.789		NA	Director/D
B.7069	South	MOHALI	11kV	DS DIVN. LALRU	DS S/D Mubarkpur	0306FL04	MUBARKH PUR INDUSTRIAL	AMR	OK	31.03.2023		Category 1				5388142	1200-600/5	17.039		NA	Director/D
B.7070	South	MOHALI	11kV	DS DIVN. LALRU	DS S/D Mubarkpur	FL10306	JAWAHARPUR INDUSTRIAL	AMR	OK	31.03.2023		Category 2				2066415	1200-600/5	18.201		NA	Director/D
B.7071	South	MOHALI	11kV	DS DIVN. LALRU	DS S/D Mubarkpur	0306FL17	YARDHAMAN	NON AMR	OK	31.03.2023		Category 1				1234	1800-900	19.265		NA	Director/D
B.7072	South	MOHALI	11kV	DS DIVN. LALRU	DS S/D Mubarkpur	0306FL20	AQUA FIBRE	NON AMR	OK	31.03.2023		Category 4				1234	1200-600/5	23.859		NA	Director/D
B.7073	South	MOHALI	11kV	DS DIVN. LALRU	DS S/D Mubarkpur	0306FL24	OASIS TEXTILE	AMR	OK	31.03.2023		Category 2				1234	1200-600/5	25.157		NA	Director/D
B.7074	South	MOHALI	11kV	DS DIVN. LALRU	DS S/D Mubarkpur	0306FL15	PCPL	Not available	OK	31.03.2023		Category 4				2066431	1200-600/5	26.865		NA	Director/D
B.7075	South	MOHALI	66kV	DS DIVN. LALRU	DS S/D Mubarkpur	0306OL02	SADASHV	NON AMR	OK	31.03.2023		Category 3				Not available	Not available	22.973		NA	Director/D
B.7076	South	MOHALI	11kV	DS DIVN. LALRU	DS S/D Mubarkpur	0306FL07	THAKAR UNIVERSITY	AMR	OK	31.03.2023		Category 1				23737	1200-600/5	8.611		NA	Director/D
B.7077	South	MOHALI	11kV	DS DIVN. LALRU	DS S/D Mubarkpur	0306FL30	BARDOL	NON AMR	OK	31.03.2023		Kandi Pure AP				1234	400-200/5-5	1.883		NA	Director/D
B.7078	South	MOHALI	11kV	DS DIVN. LALRU	DS S/D Mubarkpur	0306FL05	Indus Hospital Feeder	NON AMR	OK	31.03.2023		Category 1				123	400-200/5-5	1.889		NA	Director/D
B.7079	South	MOHALI	11kV	DS DIVN. LALRU	DS S/D Mubarkpur	0306FL28	BAHORA	NON AMR	OK	31.03.2023		Kandi Pure AP				23401	400-200/5-5	3.114		NA	Director/D
B.7080	South	MOHALI	11kV	DS DIVN. LALRU	DS S/D Mubarkpur	0306FL02	MEHMADPUR	NON AMR	OK	31.03.2023		Kandi Mixed				23705	400-200/5-5	3.588		NA	Director/D
B.7081	South	MOHALI	11kV	DS DIVN. LALRU	DS S/D Mubarkpur	0306FL29	CHADALA	AMR	OK	31.03.2023		Kandi Pure AP				1319695	400-200/5-5	2.741		NA	Director/D
B.7082	South	MOHALI	11kV	DS DIVN. LALRU	DS S/D Mubarkpur	0306FL26	JANETPUR	NON AMR	OK	31.03.2023		Category 5-UPS				1259	400-200/5-5	6.573		NA	Director/D
B.7083	South	MOHALI	11kV	DS DIVN. LALRU	DS S/D Mubarkpur	0306FL03	SHEKHUP KALAN	AMR	OK	31.03.2023		Category 5-UPS				23430	400-200/5-5	8.831		NA	Director/D
B.7084	South	MOHALI	11kV	DS DIVN. LALRU	DS S/D SAIDPURA	8302FL19	DERABASSI URBAN II	AMR	OK	31.03.2023		Category 1				2067963	900-450/577/1-1	0.000		NA	Director/D
B.7085	South	MOHALI	11kV	DS DIVN. LALRU	DS S/D SAIDPURA	8302FL16	HOSPITAL FEEDER	AMR	OK	31.03.2023		Category 4				23246	1200/577/1-1	0.102		NA	Director/D
B.7086	South	MOHALI	11kV	DS DIVN. LALRU	DS S/D SAIDPURA	8302E029	ABRYL LAB	AMR	OK	31.03.2023		Category 2				24568	1200/577/1-1	1.388		NA	Director/D
B.7087	South	MOHALI	11kV	DS DIVN. LALRU	DS S/D SAIDPURA	8302E127	ATS-2	NON AMR	OK	31.03.2023		Category 1				789	1200/577/1-1	3.927		NA	Director/D
B.7088	South	MOHALI	11kV	DS DIVN. LALRU	DS S/D SAIDPURA	8302FL06	MAHIWALA	AMR	OK	31.03.2023		Kandi Mixed				77	1200/577/1-1	4.516		NA	Director/D
B.7089	South	MOHALI	11kV	DS DIVN. LALRU	DS S/D SAIDPURA	8302FL07	PML	AMR	OK	31.03.2023		Category 2				5295709	1200/577/1-1	5.645		NA	Director/D
B.7090	South	MOHALI	11kV	DS DIVN. LALRU	DS S/D SAIDPURA	8302E39	11KV BEHRA FEEDER	AMR	OK	31.03.2023		Category 5-UPS				1114522	900-450/577/1-1	5.909		NA	Director/D
B.7091	South	MOHALI	11kV	DS DIVN. LALRU	DS S/D SAIDPURA	8302FL14	ATS FEEDER	AMR	OK	31.03.2023		Category 1				6745295	1200/577/1-1	6.621		NA	Director/D
B.7092	South	MOHALI	11kV	DS DIVN. LALRU	DS S/D SAIDPURA	8302FL18	ALASKA FABTECH	AMR	OK	31.03.2023		Category 2				1234	1800-900	6.955		NA	Director/D
B.7093	South	MOHALI	11kV	DS DIVN. LALRU	DS S/D SAIDPURA	8302FL09	REAR PUR SAINAN	AMR	OK	31.03.2023		Kandi Mixed				2046984	900-450/577/1-1	9.987		NA	Director/D
B.7094	South	MOHALI	11kV	DS DIVN. LALRU	DS S/D SAIDPURA	8302FL01	SAIDPURA	AMR	OK	31.03.2023		Category 2				6675724	900-450/577/1-1	7.206		NA	Director/D
B.7095	South	MOHALI	11kV	DS DIVN. LALRU	DS S/D SAIDPURA	8302FL10	SURYA MEDICARE	AMR	OK	31.03.2023		Category 2				8223678	1200/577/1-1	7.442		NA	Director/D
B.7096	South	MOHALI	11kV	DS DIVN. LALRU	DS S/D SAIDPURA	8302FL13	INDO SWIFT	NON AMR	OK	31.03.2023		Category 2				1114522	1200/577/1-1	8.266		NA	Director/D
B.7097	South	MOHALI	11kV	DS DIVN. LALRU	DS S/D SAIDPURA	8302FL02	VATIKA	AMR	OK	31.03.2023		Category 2				12345	1800-900	8.820		NA	Director/D
B.7098	South	MOHALI	11kV	DS DIVN. LALRU	DS S/D SAIDPURA	8302FL30	NECTOR	AMR	OK	31.03.2023		Category 2				1234	1800-900	9.132		NA	Director/D
B.7099	South	MOHALI	11kV	DS DIVN. LALRU	DS S/D SAIDPURA	8302FL05	DERA BASSI URBAN	AMR	OK	31.03.2023		Category 2				2068383	900-450/577/1-1	9.368		NA	Director/D
B.7100	South	MOHALI	11kV	DS DIVN. LALRU	DS S/D SAIDPURA	8302FL09	ABBOT COLD STORE	NON AMR	OK	31.03.2023		Category 2				1234	1800-900	9.631		NA	Director/D
B.7101	South	MOHALI	11kV	DS DIVN. LALRU	DS S/D SAIDPURA	8302FL15	INDOSWIFT LAB	AMR	OK	31.03.2023		Category 2				12345	1200/577/1-1	10.039		NA	Director/D
B.7102	South	MOHALI	11kV	DS DIVN. LALRU	DS S/D SAIDPURA	8302FL08	BARWALA ROAD	NON AMR	OK	31.03.2023		Category 2				1234	1800-900	10.240		NA	Director/D
B.7103	South	MOHALI	11kV	DS DIVN. LALRU	DS S/D SAIDPURA	8302FL34	URBAN-3 DERABASSI	AMR	OK	31.03.2023		Category 1				123456	1200/577/1-1	10.510		NA	Director/D
B.7104	South	MOHALI	11kV	DS DIVN. LALRU	DS S/D SAIDPURA	8302FL11	URBAN-3	AMR	OK	31.03.2023		Category 1				1234	1200/577/1-1	11.156		NA	Director/D
B.7105	South	MOHALI	11kV	DS DIVN. LALRU	DS S/D SAIDPURA	8302FL35	USHA VARNIS	AMR	OK	31.03.2023		Category 4				1114527	900-450/577/1-1	11.330		NA	Director/D
B.7106	South	MOHALI	11kV	DS DIVN. LALRU	DS S/D SAIDPURA	8302FL37	barvala industrial park	NON AMR	OK	31.03.2023		Category 2				7338661	900-450/577/1-1	11.434		NA	Director/D
B.7107	South	MOHALI	11kV	DS																	

S.No	Zone	Circle	Voltage Level (kVA)	Division (kVA)	Sub-Division (kVA)	Feeder ID	Feeder Name	Feeder Metering Status (Metered/unmetered/AMR/AMI)	Status of Meter (Functional/Non-functional)	Metering Date	Feeder Type (Agr./Industrial/Mixed)	Status of Communication			Period from 01.04.2021 to 31.03.2022				Sales	Remarks (Source of data)
												% data received through automatically if feeder AMR/AMI	Number of hours when meter was unable to communicate in period	Total Number of hours in the period	Meter S.No	CT/PT ratio	Import (kWh)	Export (kWh)		
B.7148	South	MOHALI	11kV	D5 DIVN. ZIRAKPUR	D5 S/D BANUR	D313FL12	SIGMA	AMR	OK	31.03.2023	Category 2				23241	900-450/577/1-1-1	17.624	NA	Director/D	
B.7149	South	MOHALI	11kV	D5 DIVN. ZIRAKPUR	D5 S/D BANUR	D310FL18	HULKA UPS	NON AMR	OK	31.03.2023	Category 5-UPS				6679928	1200-600/5	0.000	NA	Director/D	
B.7150	South	MOHALI	11kV	D5 DIVN. ZIRAKPUR	D5 S/D BANUR	B304FL19	SUB STATION VCB T1	NON AMR	OK	31.03.2023	Substation Transformer				12345	900-450/577/1-1-1	0.064	NA	Director/D	
B.7151	South	MOHALI	11kV	D5 DIVN. ZIRAKPUR	D5 S/D BANUR	B304FL20	SUB STATION VCB T2	AMR	OK	31.03.2023	Substation Transformer				12345	1200-600/5	0.085	NA	Director/D	
B.7152	South	MOHALI	11kV	D5 DIVN. ZIRAKPUR	D5 S/D BANUR	D310FL21	HOUSEFED	AMR	OK	31.03.2023	Category 1				4179727	1200-600/5	1.289	NA	Director/D	
B.7153	South	MOHALI	11kV	D5 DIVN. ZIRAKPUR	D5 S/D BANUR	D310FL25	KANOUR	AMR	OK	31.03.2023	AP 3Phase 3Wire				1234	1200-600/5	1.304	NA	Director/D	
B.7154	South	MOHALI	11kV	D5 DIVN. ZIRAKPUR	D5 S/D BANUR	D310FL06	DEERI	AMR	OK	31.03.2023	AP 3Phase 3Wire				8222519	900-450/577/1-1-1	1.815	NA	Director/D	
B.7155	South	MOHALI	11kV	D5 DIVN. ZIRAKPUR	D5 S/D BANUR	D310FL02	DHARAMGHAR	AMR	OK	31.03.2023	AP 3Phase 3Wire				8223601	1200-600/5	1.939	NA	Director/D	
B.7156	South	MOHALI	11kV	D5 DIVN. ZIRAKPUR	D5 S/D BANUR	D310FL22	Saharajyaya AP	AMR	OK	31.03.2023	AP 3Phase 3Wire				123456	1200-600/5	2.155	NA	Director/D	
B.7157	South	MOHALI	11kV	D5 DIVN. ZIRAKPUR	D5 S/D BANUR	D310FL07	BANUR RURAL	AMR	OK	31.03.2023	AP 3Phase 3Wire				8223603	1200-600/5	2.448	NA	Director/D	
B.7158	South	MOHALI	11kV	D5 DIVN. ZIRAKPUR	D5 S/D BANUR	D310FL24	MATHARAN	AMR	OK	31.03.2023	AP 3Phase 3Wire				1234	1200-600/5	2.553	NA	Director/D	
B.7159	South	MOHALI	11kV	D5 DIVN. ZIRAKPUR	D5 S/D BANUR	D310FL10	KURALI	AMR	OK	31.03.2023	AP 3Phase 3Wire				9154241	1200-600/5	2.592	NA	Director/D	
B.7160	South	MOHALI	11kV	D5 DIVN. ZIRAKPUR	D5 S/D BANUR	D310FL12	BOOTA SINGH WALA	AMR	OK	31.03.2023	AP 3Phase 3Wire				2066407	1200-600/5	3.110	NA	Director/D	
B.7161	South	MOHALI	11kV	D5 DIVN. ZIRAKPUR	D5 S/D BANUR	D310FL05	HULKA	AMR	OK	31.03.2023	AP 3Phase 3Wire				5390816	900-450/577/1-1-1	3.110	NA	Director/D	
B.7162	South	MOHALI	11kV	D5 DIVN. ZIRAKPUR	D5 S/D BANUR	D310FL04	BANUR URBAN-2	AMR	OK	31.03.2023	Category 1				2065844	900-450/577/1-1-1	6.883	NA	Director/D	
B.7163	South	MOHALI	11kV	D5 DIVN. ZIRAKPUR	D5 S/D BANUR	D310FL17	Banur Urban 3	AMR	OK	31.03.2023	Category 1				11117002	1200-600/5	10.720	NA	Director/D	
B.7164	South	MOHALI	11kV	D5 DIVN. ZIRAKPUR	D5 S/D BANUR	D310FL13	MOTE MAIRA	AMR	OK	31.03.2023	Category 5-UPS				2067536	900-450/577/1-1-1	12.575	NA	Director/D	
B.7165	South	MOHALI	11kV	D5 DIVN. ZIRAKPUR	D5 S/D BANUR	D310FL03	BANUR URBAN-1	NON AMR	OK	31.03.2023	Category 1				2066786	900-450/577/1-1-1	14.032	NA	Director/D	
B.7166	South	MOHALI	11kV	D5 DIVN. ZIRAKPUR	D5 S/D Comm. ZIRAKPUR	D311FL08	11 kv Aero Home Feeder	NON AMR	OK	31.03.2023	Category 1				1319053	900-450/577/1-1-1	13.420	NA	Director/D	
B.7167	South	MOHALI	11kV	D5 DIVN. ZIRAKPUR	D5 S/D Comm. ZIRAKPUR	D311FL07	MURPOT	AMR	OK	31.03.2023	Category 1				45190609	900-450/577/1-1-1	0.200	NA	Director/D	
B.7168	South	MOHALI	11kV	D5 DIVN. ZIRAKPUR	D5 S/D Comm. ZIRAKPUR	D326FL10	ZOD FEDER	AMR	OK	31.03.2023	Category 1				1234	400-200/5	0.563	NA	Director/D	
B.7169	South	MOHALI	11kV	D5 DIVN. ZIRAKPUR	D5 S/D Comm. ZIRAKPUR	D326FL02	BARRI	NON AMR	OK	31.03.2023	AP 3Phase 3Wire				3248	400-200/5	0.621	NA	Director/D	
B.7170	South	MOHALI	11kV	D5 DIVN. ZIRAKPUR	D5 S/D Comm. ZIRAKPUR	D326FL03	SIDHU	NON AMR	OK	31.03.2023	Category 5-UPS				12345	400-200/5	11.275	NA	Director/D	
B.7171	South	MOHALI	11kV	D5 DIVN. ZIRAKPUR	D5 S/D Comm. ZIRAKPUR	D326FL01	AERO CITY	AMR	OK	31.03.2023	Category 1				12345	400-200/5	12.018	NA	Director/D	
B.7172	South	MOHALI	11kV	D5 DIVN. ZIRAKPUR	D5 S/D Comm. ZIRAKPUR	D327FL08	BE GAMPURA	AMR	OK	31.03.2023	Category 1				1234	400-200/5	0.190	NA	Director/D	
B.7173	South	MOHALI	11kV	D5 DIVN. ZIRAKPUR	D5 S/D Comm. ZIRAKPUR	D327FL05	SATLU	NON AMR	OK	31.03.2023	Category 1				4843	400-200/5	0.724	NA	Director/D	
B.7174	South	MOHALI	11kV	D5 DIVN. ZIRAKPUR	D5 S/D Comm. ZIRAKPUR	D327FL01	DHILLON	NON AMR	OK	31.03.2023	Category 1				4706	400-200/5	4.433	NA	Director/D	
B.7175	South	MOHALI	11kV	D5 DIVN. ZIRAKPUR	D5 S/D Comm. ZIRAKPUR	D327FL07	Bhudda Sahib	NON AMR	OK	31.03.2023	Category 1				123456	400-200/5	6.880	NA	Director/D	
B.7176	South	MOHALI	11kV	D5 DIVN. ZIRAKPUR	D5 S/D Comm. ZIRAKPUR	D327FL03	SIMRAN	NON AMR	OK	31.03.2023	Category 1				467	400-200/5	10.689	NA	Director/D	
B.7177	South	MOHALI	11kV	D5 DIVN. ZIRAKPUR	D5 S/D Comm. ZIRAKPUR	D327FL02	PRIITHAM	AMR	OK	31.03.2023	Category 1				4599	400-200/5	13.014	NA	Director/D	
B.7178	South	MOHALI	11kV	D5 DIVN. ZIRAKPUR	D5 S/D Comm. ZIRAKPUR	D310FL15	ZOD FEDER	AMR	OK	31.03.2023	Category 4				123456	1200-600/5	0.000	NA	Director/D	
B.7179	South	MOHALI	11kV	D5 DIVN. ZIRAKPUR	D5 S/D Comm. ZIRAKPUR	D311FL28	GREEN LOTUS	AMR	OK	31.03.2023	Category 1				6679852	1200-600/5	0.058	NA	Director/D	
B.7180	South	MOHALI	11kV	D5 DIVN. ZIRAKPUR	D5 S/D Comm. ZIRAKPUR	D311FL03	Bhabat	AMR	OK	31.03.2023	Category 1				6679889	1200-600/5	1.358	NA	Director/D	
B.7181	South	MOHALI	11kV	D5 DIVN. ZIRAKPUR	D5 S/D Comm. ZIRAKPUR	D311FL05	Rampur kalan	AMR	OK	31.03.2023	AP 3Phase 3Wire				6740733	1200-600/5	1.456	NA	Director/D	
B.7182	South	MOHALI	11kV	D5 DIVN. ZIRAKPUR	D5 S/D Comm. ZIRAKPUR	D311FL27	RAJ VIHAR	NON AMR	OK	31.03.2023	Category 1				12345	400-200/5	1.941	NA	Director/D	
B.7183	South	MOHALI	11kV	D5 DIVN. ZIRAKPUR	D5 S/D Comm. ZIRAKPUR	D311FL04	M.E.S	NON AMR	OK	31.03.2023	Category 4				12345	1200-600/5	1.979	NA	Director/D	
B.7184	South	MOHALI	11kV	D5 DIVN. ZIRAKPUR	D5 S/D Comm. ZIRAKPUR	D311FL24	TRESHA	AMR	OK	31.03.2023	Category 1				12345	400-200/5	2.338	NA	Director/D	
B.7185	South	MOHALI	11kV	D5 DIVN. ZIRAKPUR	D5 S/D Comm. ZIRAKPUR	D311FL07	SINGHPURA	AMR	OK	31.03.2023	Category 1				9154412	1200/577/1-1-1	2.445	NA	Director/D	
B.7186	South	MOHALI	11kV	D5 DIVN. ZIRAKPUR	D5 S/D Comm. ZIRAKPUR	D311FL01	Nadiali	AMR	OK	31.03.2023	AP 3Phase 3Wire				9154353	1200-600/5	2.469	NA	Director/D	
B.7187	South	MOHALI	11kV	D5 DIVN. ZIRAKPUR	D5 S/D Comm. ZIRAKPUR	D311FL21	KURRI	AMR	OK	31.03.2023	AP 3Phase 3Wire				1234	1200-600/5	3.037	NA	Director/D	
B.7188	South	MOHALI	11kV	D5 DIVN. ZIRAKPUR	D5 S/D Comm. ZIRAKPUR	D311FL02	ZIRAKPUR-2	AMR	OK	31.03.2023	Category 1				5463638	1200-600/5	7.313	NA	Director/D	
B.7189	South	MOHALI	11kV	D5 DIVN. ZIRAKPUR	D5 S/D Comm. ZIRAKPUR	D311FL26	Suhmani Sahib	AMR	OK	31.03.2023	Category 1				123	1200/577/1-1-1	8.187	NA	Director/D	
B.7190	South	MOHALI	11kV	D5 DIVN. ZIRAKPUR	D5 S/D Comm. ZIRAKPUR	D311FL09	ALUNAB	AMR	OK	31.03.2023	Category 1				5471721	1200-600/5	13.351	NA	Director/D	
B.7191	South	MOHALI	11kV	D5 DIVN. ZIRAKPUR	D5 S/D Comm. ZIRAKPUR	D311FL19	SAVITRYGREEN	NON AMR	OK	31.03.2023	Category 1				123456	1200-600/5	9.941	NA	Director/D	
B.7192	South	MOHALI	11kV	D5 DIVN. ZIRAKPUR	D5 S/D Comm. ZIRAKPUR	D311FL15	ECME	NON AMR	OK	31.03.2023	Category 1				12345	400-200/5	11.766	NA	Director/D	
B.7193	South	MOHALI	11kV	D5 DIVN. ZIRAKPUR	D5 S/D Comm. ZIRAKPUR	D311FL16	11 kv Japuria Feeder	AMR	OK	31.03.2023	Category 1				23475	1200-600/5	11.770	NA	Director/D	
B.7194	South	MOHALI	11kV	D5 DIVN. ZIRAKPUR	D5 S/D Comm. ZIRAKPUR	D311FL13	Jaskaran	AMR	OK	31.03.2023	Category 1				37188	1200/577/1-1-1	11.798	NA	Director/D	
B.7195	South	MOHALI	11kV	D5 DIVN. ZIRAKPUR	D5 S/D Comm. ZIRAKPUR	D311FL17	SANBURY	AMR	OK	31.03.2023	Category 1				10243500	1200/577/1-1-1	12.320	NA	Director/D	
B.7196	South	MOHALI	11kV	D5 DIVN. ZIRAKPUR	D5 S/D Comm. ZIRAKPUR	D311FL06	ZIRAKPUR-1	AMR	OK	31.03.2023	Category 1				2067555	1200-600/5	12.734	NA	Director/D	
B.7197	South	MOHALI	11kV	D5 DIVN. ZIRAKPUR	D5 S/D Comm. ZIRAKPUR	D311FL18	SILVERCITY	AMR	OK	31.03.2023	Category 1				37227	1200/577/1-1-1	12.835	NA	Director/D	
B.7198	South	MOHALI	11kV	D5 DIVN. ZIRAKPUR	D5 S/D Comm. ZIRAKPUR	D311FL25	NARHA SAHIB	AMR	OK	31.03.2023	Category 1				2067918	1200-600/5	13.261	NA	Director/D	
B.7199	South	MOHALI	11kV	D5 DIVN. ZIRAKPUR	D5 S/D Comm. ZIRAKPUR	D311FL22	PEER BABA ROAD	AMR	OK	31.03.2023	Category 1				1234	1200-600/5	13.506	NA	Director/D	
B.7200	South	MOHALI	11kV	D5 DIVN. ZIRAKPUR	D5 S/D Comm. ZIRAKPUR	D311FL11	ORBIT	NON AMR	OK	31.03.2023	Category 1				9154300	1200-600/5	13.541	NA	Director/D	
B.7201	South	MOHALI	11kV	D5 DIVN. ZIRAKPUR	D5 S/D Comm. ZIRAKPUR	D311FL12	ROYAL ESTATE	AMR	OK	31.03.2023	Category 1				12345	400-200/5	13.861	NA	Director/D	
B.7202	South	MOHALI	11kV	D5 DIVN. ZIRAKPUR	D5 S/D Comm. ZIRAKPUR	D311FL10	ASSTA	AMR	OK	31.03.2023	Category 1				5341682	1200/577/1-1-1	13.914	NA	Director/D	
B.7203	South	MOHALI	11kV	D5 DIVN. ZIRAKPUR	D5 S/D Comm. ZIRAKPUR	D311FL08	ADDA HUNGIAN	AMR	OK	31.03.2023	Category 5-UPS				23294	1200-600/5	14.545	NA	Director/D	
B.7204	South	MOHALI	11kV	D5 DIVN. ZIRAKPUR	D5 S/D Comm. ZIRAKPUR	D311FL20	11 KV AMBALA ROAD	NON AMR	OK	31.03.2023	Category 1				1234	1200-600/5	16.288	NA	Director/D	
B.7205	South	MOHALI	11kV	D5 DIVN. ZIRAKPUR	D5 S/D Comm. ZIRAKPUR	B305FL12	NADIALI JAGATPUR	AMR	OK	31.03.2023	AP 3Phase 3Wire				10282936	1200-600/5	2.464	NA	Director/D	
B.7206	South	MOHALI	11kV	D5 DIVN. ZIRAKPUR	D5 S/D Comm. ZIRAKPUR	D310FL08	BANUR RURAL													

S.No	Zone	Circle	Voltage Level (kVA)	Division (kVA)	Sub-Division (kVA)	Feeder ID	Feeder Name	Feeder Metering Status (Metred/unmetred/AMR/AM)	Status of Meter (Functional/Non-Functional)	Metering Date	Feeder Type (Agr/Industrial/Mixed)	Status of Communication			Period from 01.04.2021 to 31.03.2022				Sales	Remarks (Source of data)
												% data received through automatically if feeder AMR/AM	Number of hours when meter was unable to communicate in overall	Total Number of hours in the period	Meter S.No	CT/PT ratio	Import (kU)	Export (kU)		
B.7245	South	MOHALI	11KV	DS SPL. DIVN. MOHALI	DS S/D MULLANPUR GARIBADAS	0321FL05	11 KV Gura	AMR	OK	31.03.2023	Category 5-UPS				1234	900-450/577/1-1-1	6.383	NA	Director/D	
B.7246	South	MOHALI	11KV	DS SPL. DIVN. MOHALI	DS S/D MULLANPUR GARIBADAS	0321FL06	11 KV Masol	NON AMR	OK	31.03.2023	Category 5-UPS				1234	900-450/577/1-1-1	7.715	NA	Director/D	
B.7247	South	MOHALI	11KV	DS SPL. DIVN. MOHALI	DS S/D MULLANPUR GARIBADAS	0321FL03	11 KV Kansal	NON AMR	OK	31.03.2023	Category 1				13190551	900-450/577/1-1-1	15.195	NA	Director/D	
B.7248	South	MOHALI	11KV	DS SPL. DIVN. MOHALI	DS S/D MULLANPUR GARIBADAS	0321FL02	11 KV Shivajli Vihar	AMR	OK	31.03.2023	Category 1				13190408	900-450/577/1-1-1	15.712	NA	Director/D	
B.7249	South	MOHALI	11KV	DS SPL. DIVN. MOHALI	DS S/D MULLANPUR GARIBADAS	0253FL20	11 KV Homi Bhabh Cancer Hospit	NON AMR	OK	31.03.2023	Category 4				4906	1200/577/1-1-1	2.600	NA	Director/D	
B.7250	South	MOHALI	11KV	DS SPL. DIVN. MOHALI	DS S/D MULLANPUR GARIBADAS	0253FL12	Omase tower	NON AMR	OK	31.03.2023	Category 1				73163602	900-450/577/1-1-1	14.294	NA	Director/D	
B.7251	South	MOHALI	11KV	DS SPL. DIVN. MOHALI	DS S/D Tech - 3(SOSHANA)	0276FL17	Sector-113	NON AMR	OK	31.03.2023	Category 1				1234	1200/577/1-1-1	2.315	NA	Director/D	
B.7252	South	MOHALI	11KV	DS SPL. DIVN. MOHALI	DS S/D Tech - 3(SOSHANA)	0321FL01	SHAMPUR	NON AMR	OK	31.03.2023	AP 3Phase 3Wire				36086	400-200/5-5	1.798	NA	Director/D	
B.7253	South	MOHALI	11KV	DS SPL. DIVN. MOHALI	DS S/D Tech - 3(SOSHANA)	0321FL02	BHARTPUR	AMR	OK	31.03.2023	AP 3Phase 3Wire				36014	400-200/5-5	1.965	NA	Director/D	
B.7254	South	MOHALI	11KV	DS SPL. DIVN. MOHALI	DS S/D Tech - 3(SOSHANA)	0321FL04	Gidshargar	NON AMR	OK	31.03.2023	AP 3Phase 3Wire				37083	400-200/5-5	3.346	NA	Director/D	
B.7255	South	MOHALI	11KV	DS SPL. DIVN. MOHALI	DS S/D Tech - 3(SOSHANA)	0321FL05	RAIPUR KALAN	NON AMR	OK	31.03.2023	Category 5-UPS				37087	400-200/5-5	3.624	NA	Director/D	
B.7256	South	MOHALI	11KV	DS SPL. DIVN. MOHALI	DS S/D Tech - 3(SOSHANA)	0321FL03	CHADIALI	AMR	OK	31.03.2023	Category 5-UPS				37090	400-200/5-5	11.224	NA	Director/D	
B.7257	South	MOHALI	11KV	DS SPL. DIVN. MOHALI	DS S/D Tech - 3(SOSHANA)	0314FL06	MANALI	AMR	OK	31.03.2023	AP 3Phase 3Wire				8223077	900-450/577/1-1-1	2.269	NA	Director/D	
B.7258	South	MOHALI	11KV	DS SPL. DIVN. MOHALI	DS S/D Tech - 3(SOSHANA)	0314FL03	DURALI	AMR	OK	31.03.2023	Category 5-UPS				6740922	900-450/577/1-1-1	14.967	NA	Director/D	
B.7259	South	MOHALI	11KV	DS SPL. DIVN. MOHALI	DS S/D Tech - 3(SOSHANA)	0321FL29	11 KV 66 Beta Feeder	AMR	OK	31.03.2023	Category 1				1234	400-200/5-5	0.430	NA	Director/D	
B.7260	South	MOHALI	11KV	DS SPL. DIVN. MOHALI	DS S/D Tech - 3(SOSHANA)	0321FL31	11 KV B2 A Feeder	AMR	OK	31.03.2023	Category 1				1234	400-200/5-5	1.166	NA	Director/D	
B.7261	South	MOHALI	11KV	DS SPL. DIVN. MOHALI	DS S/D Tech - 3(SOSHANA)	0321FL30	11 KV Branch 240	NON AMR	OK	31.03.2023	Category 1				1234	400-200/5-5	2.566	NA	Director/D	
B.7262	South	MOHALI	11KV	DS SPL. DIVN. MOHALI	DS S/D Tech - 3(SOSHANA)	0321FL27	11 KV Block B, IT City	NON AMR	OK	31.03.2023	Category 1				12345	400-200/5-5	2.681	NA	Director/D	
B.7263	South	MOHALI	11KV	DS SPL. DIVN. MOHALI	DS S/D Tech - 3(SOSHANA)	0314FL10	IT CITY	NON AMR	OK	31.03.2023	Category 1				12345	400-200/5-5	8.222	NA	Director/D	
B.7264	South	MOHALI	11KV	DS SPL. DIVN. MOHALI	DS S/D Tech - 3(SOSHANA)	0321FL28	11 KV Manav Rachna 82	NON AMR	OK	31.03.2023	Category 1				123456	400-200/5-5	9.906	NA	Director/D	
B.7265	South	MOHALI	11KV	DS SPL. DIVN. MOHALI	DS S/D Tech - 3(SOSHANA)	0321FL02	11 KV Sec-88	NON AMR	OK	31.03.2023	Category 1				123456	1200/577/1-1-1	0.918	NA	Director/D	
B.7266	South	MOHALI	11KV	DS SPL. DIVN. MOHALI	DS S/D Tech - 3(SOSHANA)	0324FL02	Sector-798	AMR	OK	31.03.2023	Category 1				16199386	1200/577/1-1-1	1.464	NA	Director/D	
B.7267	South	MOHALI	11KV	DS SPL. DIVN. MOHALI	DS S/D Tech - 3(SOSHANA)	0324FL06	commercial 95-96	NON AMR	OK	31.03.2023	Category 1				1234	1200/577/1-1-1	1.861	NA	Director/D	
B.7268	South	MOHALI	11KV	DS SPL. DIVN. MOHALI	DS S/D Tech - 3(SOSHANA)	0324FL19	11KV EYE HOSPITAL	NON AMR	OK	31.03.2023	Category 4				123456	1200/577/1-1-1	5.009	NA	Director/D	
B.7269	South	MOHALI	11KV	DS SPL. DIVN. MOHALI	DS S/D Tech - 3(SOSHANA)	0324FL04	11 KV Sec-89	NON AMR	OK	31.03.2023	Category 1				12345	1200/577/1-1-1	7.412	NA	Director/D	
B.7270	South	MOHALI	11KV	DS SPL. DIVN. MOHALI	DS S/D Tech - 3(SOSHANA)	0321FL05	11 KV T9 Sec-110	NON AMR	OK	31.03.2023	Category 1				12345	1200/577/1-1-1	7.745	NA	Director/D	
B.7271	South	MOHALI	11KV	DS SPL. DIVN. MOHALI	DS S/D Tech - 3(SOSHANA)	0324FL01	Sector-778	NON AMR	OK	31.03.2023	Category 1				16199389	1200/577/1-1-1	13.534	NA	Director/D	
B.7272	South	MOHALI	11KV	DS SPL. DIVN. MOHALI	DS S/D Tech - 3(SOSHANA)	0302FL08	SOHANA	NON AMR	OK	31.03.2023	Category 1				10282770	1200-600/5	15.584	NA	Director/D	
B.7273	South	MOHALI	11KV	DS SPL. DIVN. MOHALI	DS S/D Tech - 3(SOSHANA)	0303FL08	ISER	NON AMR	OK	31.03.2023	Category 1				10282972	1200-600/5	0.000	NA	Director/D	
B.7274	South	MOHALI	11KV	DS SPL. DIVN. MOHALI	DS S/D Tech - 3(SOSHANA)	0303FL01	11 KV Feeder sec 66	NON AMR	OK	31.03.2023	Category 1				10282972	1200-600/5	0.009	NA	Director/D	
B.7275	South	MOHALI	11KV	DS SPL. DIVN. MOHALI	DS S/D Tech - 3(SOSHANA)	0303FL20	11 KV Feeder sec 66 B	NON AMR	OK	31.03.2023	Category 1				1234	1200-800/5	1.310	NA	Director/D	
B.7276	South	MOHALI	11KV	DS SPL. DIVN. MOHALI	DS S/D Tech - 3(SOSHANA)	0303FL25	ILPL Super Mega 66 A	NON AMR	OK	31.03.2023	Category 1				1234	1200-600/5	8.993	NA	Director/D	
B.7277	South	MOHALI	11KV	DS SPL. DIVN. MOHALI	DS S/D Tech - 3(SOSHANA)	0303FL11	JAGATPURA	NON AMR	OK	31.03.2023	Category 5-UPS				10283048	1200-600/5	9.322	NA	Director/D	
B.7278	South	MOHALI	11KV	DS SPL. DIVN. MOHALI	DS S/D Tech - 3(SOSHANA)	0303FL24	ILPL Mega	NON AMR	OK	31.03.2023	Category 2				1234	1200-600/5	10.714	NA	Director/D	
B.7279	South	MOHALI	11KV	DS SPL. DIVN. MOHALI	DS S/D Tech - 3(SOSHANA)	0303FL03	SEC-82	AMR	OK	31.03.2023	Category 2				9154244	1200-600/5	12.032	NA	Director/D	
B.7280	South	MOHALI	11KV	DS SPL. DIVN. MOHALI	DS S/D Tech - 3(SOSHANA)	0311FL03	SWARA	NON AMR	OK	31.03.2023	AP 3Phase 3Wire				8222502	1200-600/5	0.493	NA	Director/D	
B.7281	South	MOHALI	11KV	DS SPL. DIVN. MOHALI	DS S/D Tech - 3(SOSHANA)	0311FL06	BS	NON AMR	OK	31.03.2023	Category 1				6740926	1200-600/5	1.438	NA	Director/D	
B.7282	South	MOHALI	11KV	DS SPL. DIVN. MOHALI	DS S/D Tech - 3(SOSHANA)	0311FL14	COURT COMPLEX	NON AMR	OK	31.03.2023	Category 1				8222505	1200-600/5	1.796	NA	Director/D	
B.7283	South	MOHALI	11KV	DS SPL. DIVN. MOHALI	DS S/D Tech - 3(SOSHANA)	0311FL05	LANDRAN	NON AMR	OK	31.03.2023	Category 5-UPS				2067063	1200-600/5	11.216	NA	Director/D	
B.7284	South	MOHALI	11KV	DS SPL. DIVN. MOHALI	DS S/D Tech - 3(SOSHANA)	0312FL12	11 KV ILPLSec-90 91	NON AMR	OK	31.03.2023	Category 1				2068548	1200-600/5	12.537	NA	Director/D	
B.7285	South	MOHALI	11KV	DS SPL. DIVN. MOHALI	DS S/D Tech - 3(SOSHANA)	0315FL16	11 KV Sec-69A	NON AMR	OK	31.03.2023	Category 1				2068055	1200-600/5	3.951	NA	Director/D	
B.7286	South	MOHALI	11KV	DS SPL. DIVN. MOHALI	DS S/D Tech - 3(SOSHANA)	0315FL08	T1 PARK	NON AMR	OK	31.03.2023	Category 2				2067719	1200-800/5	4.163	NA	Director/D	
B.7287	South	MOHALI	11KV	DS SPL. DIVN. MOHALI	DS S/D Tech - 3(SOSHANA)	0315FL12	11 KV Feeder sec 69 B	NON AMR	OK	31.03.2023	Category 1				16199819	1200/577/1-1-1	1.407	NA	Director/D	
B.7288	South	MOHALI	11KV	DS SPL. DIVN. MOHALI	DS S/D Tech - 3(SOSHANA)	0315FL10	11KV FOREST FEEDER	NON AMR	OK	31.03.2023	Category 1				9534482	1200-600/5	6.117	NA	Director/D	
B.7289	South	MOHALI	11KV	DS SPL. DIVN. MOHALI	DS S/D Tech - 3(SOSHANA)	0315FL19	Sector-68 B	NON AMR	OK	31.03.2023	Category 1				15194768	1200/577/1-1-1	6.153	NA	Director/D	
B.7290	South	MOHALI	11KV	DS SPL. DIVN. MOHALI	DS S/D Tech - 3(SOSHANA)	0315FL01	SEC-69	NON AMR	OK	31.03.2023	Category 1				2068055	1200-600/5	7.282	NA	Director/D	
B.7291	South	MOHALI	11KV	DS SPL. DIVN. MOHALI	DS S/D Tech - 3(SOSHANA)	0315FL11	11 KV Feeder sec 68A	NON AMR	OK	31.03.2023	Category 1				16199432	1200/577/1-1-1	9.553	NA	Director/D	
B.7292	South	MOHALI	66KV	DS SPL. DIVN. MOHALI	DS S/D Tech - 3(SOSHANA)	0315FL02	SEC-68	Not available	OK	31.03.2023	Category 1				1619956	1200-600/5	12.115	NA	Director/D	
B.7293	South	MOHALI	66KV	DS SPL. DIVN. MOHALI	DS S/D Tech - 3(SOSHANA)	8303FL14	ISER	NON AMR	OK	31.03.2023	Category 1				Not available	Not available	8.802	NA	Director/D	
B.7294	South	MOHALI	11KV	DS SPL. DIVN. MOHALI	DS S/D Tech - 3(SOSHANA)	8303FL06	AP CHILLA	AMR	OK	31.03.2023	AP 3Phase 3Wire				6740704	1200-600/5	0.694	NA	Director/D	
B.7295	South	MOHALI	11KV	DS SPL. DIVN. MOHALI	DS S/D Tech - 3(SOSHANA)	8303FL11	SEC-77	NON AMR	OK	31.03.2023	Category 1				2066157	1200-600/5	1.553	NA	Director/D	
B.7296	South	MOHALI	11KV	DS SPL. DIVN. MOHALI	DS S/D Tech - 3(SOSHANA)	8303FL10	HOUSEFED	NON AMR	OK	31.03.2023	Category 1				7030187	1200-600/5	3.688	NA	Director/D	
B.7297	South	MOHALI	11KV	DS SPL. DIVN. MOHALI	DS S/D Tech - 3(SOSHANA)	8303FL28	11KV NABI	NON AMR	OK	31.03.2023	Category 1				12093565	1200-600/5	5.645	NA	Director/D	
B.7298	South	MOHALI	11KV	DS SPL. DIVN. MOHALI	DS S/D Tech - 3(SOSHANA)	8303FL08	Sec-56	NON AMR	OK	31.03.2023	Category 1				12093565	1200-600/5	1.961	NA	Director/D	
B.7299	South	MOHALI	11KV	DS SPL. DIVN. MOHALI	DS S/D Tech - 3(SOSHANA)	8303FL13	SEC-78	NON AMR	OK	31.03.2023	Category 1				7421588	1200-600/5	7.605	NA	Director/D	
B.7300	South	MOHALI	11KV	DS SPL. DIVN. MOHALI	DS S/D Tech - 3(SOSHANA)	8303FL01	MOULI	AMR	OK	31.03.2023	Category 1				6740702	1200-600/5	8.776	NA	Director/D	
B.7301	South	MOHALI	11KV	DS SPL. DIVN. MOHALI	DS S/D Tech - 3(SOSHANA)	8303FL07	SEC 67	NON AMR	OK	31.03.2023	Category 1				11114505	1200-600/5				

S.No	Zone	Circle	Voltage Level (kVA)	Division (kVA)	Sub-Division (kVA)	Feeder ID	Feeder Name	Feeder Metering Status (Metered/unmetered/AMR/AMI)	Status of Meter (Functional/Non-functional)	Metering Date (Date of last actual meter reading/communication)	Feeder Type (Agr/Industrial/Mixed)	Status of Communication			Period from 01.04.2021 to 31.03.2022				Sales	Remarks (Source of data)
												% data received through automatically if feeder AMR/AMI	Number of hours when meter was unable to communicate in overall	Total Number of hours in the period	Meter S.No	CT/PT ratio	Import (kWh)	Export (kWh)		
B.7342	South	MOHALI	11kV	D5 SPL. DIVN. MOHALI	TECH UNIT-1 MOHALI	D312FL16	11 KV SBP Homes	Not available	OK	31.03.2023	Category 1				2065791	1200-600/5	6.410	NA	Director/D	
B.7343	South	MOHALI	11kV	D5 SPL. DIVN. MOHALI	TECH UNIT-1 MOHALI	D303FL26	Colony phase 1	Not available	OK	31.03.2023	Category 1				Not available	Not available	10.855	NA	Director/D	
B.7344	South	MOHALI	66kV	D5 SPL. DIVN. MOHALI	TECH UNIT-1 MOHALI	B301C-18	HAMIR REAL ESTATE BALLAMOJRA	Not available	OK	31.03.2023	Category 1				Not available	Not available	0.051	NA	Director/D	
B.7345	South	MOHALI	66kV	D5 SPL. DIVN. MOHALI	TECH UNIT-1 MOHALI	B301C14	PTI	Not available	OK	31.03.2023	Category 4				Not available	Not available	16.054	NA	Director/D	
B.7346	South	MOHALI	11kV	D5 SPL. DIVN. MOHALI	TECH UNIT-1 MOHALI	D318FL07	Sec-53A	AMR	OK	31.03.2023	Category 1				23552	400-200/5-5	1.438	NA	Director/D	
B.7347	South	MOHALI	11kV	D5 SPL. DIVN. MOHALI	TECH UNIT-1 MOHALI	D318FL08	11 KV Sec-60 C	NON AMR	OK	31.03.2023	Category 1				17051337	400-200/5-5	9.779	NA	Director/D	
B.7348	South	MOHALI	11kV	D5 SPL. DIVN. MOHALI	TECH UNIT-1 MOHALI	D318FL02	60-A	NON AMR	OK	31.03.2023	Category 1				10282840	1200-600/5	11.094	NA	Director/D	
B.7349	South	MOHALI	11kV	D5 SPL. DIVN. MOHALI	TECH UNIT-1 MOHALI	D318FL03	11 KV Sec-60 B	NON AMR	OK	31.03.2023	Category 1				10282801	400-200/5-5	11.633	NA	Director/D	
B.7350	South	MOHALI	11kV	D5 SPL. DIVN. MOHALI	TECH UNIT-2 MOHALI	D303FL16	Industry 7A	NON AMR	OK	31.03.2023	Category 2				1234	400-200/5	NA	Director/D		
B.7351	South	MOHALI	11kV	D5 SPL. DIVN. MOHALI	TECH UNIT-2 MOHALI	D303FL06	72-B	NON AMR	OK	31.03.2023	Category 2				12345	400-200/5-5	3.563	NA	Director/D	
B.7352	South	MOHALI	11kV	D5 SPL. DIVN. MOHALI	TECH UNIT-2 MOHALI	D303FL09	72-A	AMR	OK	31.03.2023	Category 2				12527308	1200-600/5	5.967	NA	Director/D	
B.7353	South	MOHALI	11kV	D5 SPL. DIVN. MOHALI	TECH UNIT-2 MOHALI	D3024866	BSNL	NON AMR	OK	31.03.2023	Category 2				15194866	400-200/5-5	6.029	NA	Director/D	
B.7354	South	MOHALI	11kV	D5 SPL. DIVN. MOHALI	TECH UNIT-2 MOHALI	D302FL11	11 KV Sec-72 D	NON AMR	OK	31.03.2023	Category 1				15196106	400-200/5-5	7.764	NA	Director/D	
B.7355	South	MOHALI	11kV	D5 SPL. DIVN. MOHALI	TECH UNIT-2 MOHALI	D302FL04	URBAN III	NON AMR	OK	31.03.2023	Category 1				12527352	1200-600/5	8.142	NA	Director/D	
B.7356	South	MOHALI	11kV	D5 SPL. DIVN. MOHALI	TECH UNIT-2 MOHALI	D302FL12	11 KV Connect	NON AMR	OK	31.03.2023	Category 2				123456	400-200/5-5	8.614	NA	Director/D	
B.7357	South	MOHALI	11kV	D5 SPL. DIVN. MOHALI	TECH UNIT-2 MOHALI	D302FL05	Punwite	NON AMR	OK	31.03.2023	Category 2				12023486	1200-600/5	10.134	NA	Director/D	
B.7358	South	MOHALI	11kV	D5 SPL. DIVN. MOHALI	TECH UNIT-2 MOHALI	D302FL10	Urban II	NON AMR	OK	31.03.2023	Category 1				2065826	1200-600/5	11.228	NA	Director/D	
B.7359	South	MOHALI	11kV	D5 SPL. DIVN. MOHALI	TECH UNIT-2 MOHALI	D302FL03	Sec-72 C	NON AMR	OK	31.03.2023	Category 2				2068394	1200-600/5	11.306	NA	Director/D	
B.7360	South	MOHALI	11kV	D5 SPL. DIVN. MOHALI	TECH UNIT-2 MOHALI	D302FL07	ESPL	NON AMR	OK	31.03.2023	Category 2				12093505	1200-600/5	11.832	NA	Director/D	
B.7361	South	MOHALI	11kV	D5 SPL. DIVN. MOHALI	TECH UNIT-2 MOHALI	D302FL02	Ind Ph 7	NON AMR	OK	31.03.2023	Category 2				2067502	1200-600/5	15.116	NA	Director/D	
B.7362	South	MOHALI	11kV	D5 SPL. DIVN. MOHALI	TECH UNIT-2 MOHALI	D302FL18	WATER WORKS	NON AMR	OK	31.03.2023	Category 4				5342159	1200-600/5	1.858	NA	Director/D	
B.7363	South	MOHALI	11kV	D5 SPL. DIVN. MOHALI	TECH UNIT-2 MOHALI	D303FL05	HITECH	NON AMR	OK	31.03.2023	Category 4				1234	1200-600/5	1.895	NA	Director/D	
B.7364	South	MOHALI	11kV	D5 SPL. DIVN. MOHALI	TECH UNIT-2 MOHALI	D303D17	NIPER	NON AMR	OK	31.03.2023	Category 1				10282816	1200-600/5	2.021	NA	Director/D	
B.7365	South	MOHALI	11kV	D5 SPL. DIVN. MOHALI	TECH UNIT-2 MOHALI	D303FL15	Mandi Board	NON AMR	OK	31.03.2023	Category 1				8222501	1200-600/5	3.298	NA	Director/D	
B.7366	South	MOHALI	11kV	D5 SPL. DIVN. MOHALI	TECH UNIT-2 MOHALI	D303FL21	11 KV BESTECH	NON AMR	OK	31.03.2023	Category 1				1234	1200-600/5	3.990	NA	Director/D	
B.7367	South	MOHALI	11kV	D5 SPL. DIVN. MOHALI	TECH UNIT-2 MOHALI	D303FL13	INDUSTRIAL-4	NON AMR	OK	31.03.2023	Category 2				15196138	1200-600/5	9.120	NA	Director/D	
B.7368	South	MOHALI	11kV	D5 SPL. DIVN. MOHALI	TECH UNIT-2 MOHALI	D303FL19	11 KV Industrial-3	NON AMR	OK	31.03.2023	Category 2				2068364	1200-600/5	8.947	NA	Director/D	
B.7369	South	MOHALI	11kV	D5 SPL. DIVN. MOHALI	TECH UNIT-2 MOHALI	D303FL22	11 KV Industrial-4	AMR	OK	31.03.2023	Category 2				1234	1200-600/5	9.235	NA	Director/D	
B.7370	South	MOHALI	11kV	D5 SPL. DIVN. MOHALI	TECH UNIT-2 MOHALI	D303FL09	INDUSTRIAL 1	NON AMR	OK	31.03.2023	Category 2				9154025	1200-600/5	9.310	NA	Director/D	
B.7371	South	MOHALI	11kV	D5 SPL. DIVN. MOHALI	TECH UNIT-2 MOHALI	D303FL04	SEC 65	NON AMR	OK	31.03.2023	Category 1				15196138	1200-600/5	9.506	NA	Director/D	
B.7372	South	MOHALI	11kV	D5 SPL. DIVN. MOHALI	TECH UNIT-2 MOHALI	D303FL10	SEC 64-A	AMR	OK	31.03.2023	Category 1				9154025	1200-600/5	9.703	NA	Director/D	
B.7373	South	MOHALI	11kV	D5 SPL. DIVN. MOHALI	TECH UNIT-2 MOHALI	D303FL17	SEC 65-A	NON AMR	OK	31.03.2023	Category 2				9154024	1200-600/5	10.585	NA	Director/D	
B.7374	South	MOHALI	11kV	D5 SPL. DIVN. MOHALI	TECH UNIT-2 MOHALI	D303FL14	48-C	NON AMR	OK	31.03.2023	Category 1				5342159	1200-600/5	10.886	NA	Director/D	
B.7375	South	MOHALI	11kV	D5 SPL. DIVN. MOHALI	TECH UNIT-2 MOHALI	D303FL17	Globus Project	NON AMR	OK	31.03.2023	Category 1				2068035	1200-600/5	12.521	NA	Director/D	
B.7376	South	MOHALI	11kV	D5 SPL. DIVN. MOHALI	TECH UNIT-2 MOHALI	D31FL04	QUARK CITY	NON AMR	OK	31.03.2023	Category 1				2067783	1200-600/5	1.876	NA	Director/D	
B.7377	South	MOHALI	11kV	D5 SPL. DIVN. MOHALI	TECH UNIT-2 MOHALI	D31FL01	HINDUSTAN TIMES	NON AMR	OK	31.03.2023	Category 2				2066541	1200-600/5	3.199	NA	Director/D	
B.7378	South	MOHALI	11kV	D5 SPL. DIVN. MOHALI	TECH UNIT-2 MOHALI	D31FL17	11 KV Sec-74 D	NON AMR	OK	31.03.2023	Category 1				15196566	1200-600/5	3.216	NA	Director/D	
B.7379	South	MOHALI	11kV	D5 SPL. DIVN. MOHALI	TECH UNIT-2 MOHALI	D31FL20	Sec-74A	NON AMR	OK	31.03.2023	Category 2				10282824	1200-600/5	8.053	NA	Director/D	
B.7380	South	MOHALI	11kV	D5 SPL. DIVN. MOHALI	TECH UNIT-2 MOHALI	D302FL13	11 KV Sec-73	NON AMR	OK	31.03.2023	Category 2				2068379	1200-600/5	8.571	NA	Director/D	
B.7381	South	MOHALI	11kV	D5 SPL. DIVN. MOHALI	TECH UNIT-2 MOHALI	D312FL15	11 KV Sec-74 C	NON AMR	OK	31.03.2023	Category 1				4180048	1200-600/5	9.323	NA	Director/D	
B.7382	South	MOHALI	11kV	D5 SPL. DIVN. MOHALI	TECH UNIT-2 MOHALI	D312FL11	Sec-74 B	NON AMR	OK	31.03.2023	Category 2				10283014	1200-600/5	9.737	NA	Director/D	
B.7383	South	MOHALI	11kV	D5 SPL. DIVN. MOHALI	TECH UNIT-2 MOHALI	D31FL09	INDUSTRIAL BA	NON AMR	OK	31.03.2023	Category 2				4187156	1200-600/5	11.549	NA	Director/D	
B.7384	South	MOHALI	11kV	D5 SPL. DIVN. MOHALI	TECH UNIT-2 MOHALI	D31FL19	Sec-65 A	NON AMR	OK	31.03.2023	Category 2				9154024	1200-600/5	12.354	NA	Director/D	
B.7385	South	MOHALI	11kV	D5 SPL. DIVN. MOHALI	TECH UNIT-2 MOHALI	D31FL02	SWARA R&D	NON AMR	OK	31.03.2023	Category 2				6761944	1200-600/5	16.924	NA	Director/D	
B.7386	South	MOHALI	11kV	D5 SPL. DIVN. MOHALI	TECH UNIT-2 MOHALI	D315FL09	PCA	NON AMR	OK	31.03.2023	Category 1				9534534	1200-600/5	4.046	NA	Director/D	
B.7387	South	MOHALI	11kV	D5 SPL. DIVN. MOHALI	TECH UNIT-2 MOHALI	D315FL05	FORTIS	NON AMR	OK	31.03.2023	Category 1				2068089	1200-600/5	6.045	NA	Director/D	
B.7388	South	MOHALI	11kV	D5 SPL. DIVN. MOHALI	TECH UNIT-2 MOHALI	D315FL06	SEC-70	NON AMR	OK	31.03.2023	Category 1				9154051	1200-600/5	6.345	NA	Director/D	
B.7389	South	MOHALI	11kV	D5 SPL. DIVN. MOHALI	TECH UNIT-2 MOHALI	D315FL15	Sec-65A	NON AMR	OK	31.03.2023	Category 1				23460	1200-600/5	7.232	NA	Director/D	
B.7390	South	MOHALI	11kV	D5 SPL. DIVN. MOHALI	TECH UNIT-2 MOHALI	D315FL13	11 KV 63 A	NON AMR	OK	31.03.2023	Category 1				1619967	1200/577/1-1-1	7.500	NA	Director/D	
B.7391	South	MOHALI	11kV	D5 SPL. DIVN. MOHALI	TECH UNIT-2 MOHALI	D315FL03	SEC 63	NON AMR	OK	31.03.2023	Category 1				9154257	1200-600/5	7.664	NA	Director/D	
B.7392	South	MOHALI	11kV	D5 SPL. DIVN. MOHALI	TECH UNIT-2 MOHALI	D315FL04	URBAN PH-7	NON AMR	OK	31.03.2023	Category 1				6745293	1200-600/5	8.463	NA	Director/D	
B.7393	South	MOHALI	11kV	D5 SPL. DIVN. MOHALI	TECH UNIT-2 MOHALI	D303FL07	64-B	Not available	OK	31.03.2023	Category 1				2068416	1200-600/5	11.662	NA	Director/D	
B.7394	South	MOHALI	66kV	D5 SPL. DIVN. MOHALI	TECH UNIT-2 MOHALI	D303B301	66 KV DIGGANJ	Not available	OK	31.03.2023	Category 2				Not available	Not available	5.604	NA	Director/D	
B.7395	South	MOHALI	66kV	D5 SPL. DIVN. MOHALI	TECH UNIT-2 MOHALI	B303A05	SWRA ENGINE	Not available	OK	31.03.2023	Category 2				Not available	Not available	8.091	NA	Director/D	
B.7396	South	MOHALI	66kV	D5 SPL. DIVN. MOHALI	TECH UNIT-2 MOHALI	B301D08	ICI/INDIA/BANXAY	Not available	OK	31.03.2023	Category 2				Not available	Not available	17.990	NA	Director/D	
B.7397	South	MOHALI	66kV	D5 SPL. DIVN. MOHALI	TECH UNIT-2 MOHALI	B301D07	GODREJ/QUARK CITY	Not available	OK	31.03.2023	Category 4				Not available	Not available	18.021	NA	Director/D	
B.7398	South	MOHALI	66kV	D5 SPL. DIVN. MOHALI	TECH UNIT-2 MOHALI	B301D06	SCL	NON AMR	OK	31.03.2023	Category 4				Not available	Not available	29.358	NA	Director/D	
B.7399	South	MOHALI	11kV	D5 SPL. DIVN. MOHALI	TECH UNIT-2 MOHALI	D318FL17	11 KV Sector-71	AMR	OK	31.03.2023	Category 1				10282810	1200-600/5	3.116	NA	Director/D	
B.7400	South	MOHALI	11kV	D5 SPL. DIVN. MOHALI	TECH UNIT-2 MOHALI	D318FL12	Sec-61C	NON AMR	OK	31.03.										

S.No	Zone	Circle	Voltage Level (kVA)	Division (kVA)	Sub-Division (kVA)	Feeder ID	Feeder Name	Feeder Metering Status (Metered/unmetered/AMR/AMI)	Status of Meter (Functional/Non-Functional)	Metering Date (Date of last actual meter reading/communication)	Feeder Type (Agr/Industrial/Mixed)	Status of Communication			Period from 01.04.2021 to 31.03.2022				Sales	Remarks (Source of data)
												% data received through automatically by feeder AMR/AMI	Number of hours when meter was unable to communicate in overall	Total Number of hours in the period	Meter S.No	CT/PT ratio	Import (kWh)	Export (kWh)		
B.7439	South	PATIALA	11KV	DS Divn. Model Town,	POS EAST TECH S/D PTA	X153FL04	Samania Gate	AMR	OK	31.03.2023	Category 1				3589	1200/577/1-1-1	3.984	NA	Director/D	
B.7440	South	PATIALA	11KV	DS Divn. Model Town,	POS EAST TECH S/D PTA	X153FL05	Man ji Di Saran	AMR	OK	31.03.2023	Category 1				3584	1200/577/1-1-1	7.768	NA	Director/D	
B.7441	South	PATIALA	11KV	DS Divn. Model Town,	POS EAST TECH S/D PTA	X153FL06	Shahi Samadnan	AMR	OK	31.03.2023	Category 1				3620	1200/577/1-1-1	10.720	NA	Director/D	
B.7442	South	PATIALA	11KV	DS Divn. Model Town,	POS EAST TECH S/D PTA	X153FL03	To Bagh Colony	AMR	OK	31.03.2023	Category 1				2015	1200/577/1-1-1	11.148	NA	Director/D	
B.7443	South	PATIALA	11KV	DS Divn. Model Town,	POS EAST TECH S/D PTA	X153FL02	Qula Chowk	AMR	OK	31.03.2023	Category 1				3550	1200/577/1-1-1	12.162	NA	Director/D	
B.7444	South	PATIALA	11KV	DS Divn. Model Town,	POS EAST TECH S/D PTA	015109	City Feeder	AMR	OK	31.03.2023	Category 1				2067196	Not installed	0.028	NA	Director/D	
B.7445	South	PATIALA	11KV	DS Divn. Model Town,	POS EAST TECH S/D PTA	015103	Rai Majra	AMR	OK	31.03.2023	Category 1				4180069	Not installed	8.164	NA	Director/D	
B.7446	South	PATIALA	11KV	DS Divn. Model Town,	POS EAST TECH S/D PTA	0151F108	Anardana	Not available	OK	31.03.2023	Category 1				2066253	Not installed	10.654	NA	Director/D	
B.7447	South	PATIALA	11KV	DS Divn. Model Town,	POS EAST TECH S/D PTA	X158FL07	11 KV Grid transformer Rajindr	Not available	OK	31.03.2023	Category 1				Not available	Not available	0.000	NA	Director/D	
B.7448	South	PATIALA	66KV	DS Divn. Model Town,	POS EAST TECH S/D PTA	X158FL09	66 KV RAININDRA HOSPITAL	Not available	OK	31.03.2023	Category 1				Not available	Not available	4.308	NA	Director/D	
B.7449	South	PATIALA	66KV	DS Divn. Model Town,	POS EAST TECH S/D PTA	8151000	66 KV MES INDEPENDENT	AMR	OK	31.03.2023	Category 4				Not available	Not available	29.718	NA	Director/D	
B.7450	South	PATIALA	11KV	DS Divn. Model Town,	POS EAST TECH S/D PTA	0157FL04	Ram Ashram	AMR	OK	31.03.2023	Category 1				3267	Not installed	0.000	NA	Director/D	
B.7451	South	PATIALA	11KV	DS Divn. Model Town,	POS EAST TECH S/D PTA	0157FL16	New Moti Bagh	AMR	OK	31.03.2023	Category 1				2663	900-450/577/1-1-1	0.116	NA	Director/D	
B.7452	South	PATIALA	11KV	DS Divn. Model Town,	POS EAST TECH S/D PTA	015700	NIS Complex	AMR	OK	31.03.2023	Category 1				1583	1200/577/1-1-1	2.833	NA	Director/D	
B.7453	South	PATIALA	11KV	DS Divn. Model Town,	POS EAST TECH S/D PTA	0157FL07	Mohindra College	AMR	OK	31.03.2023	Category 1				2066553	1200/577/1-1-1	3.362	NA	Director/D	
B.7454	South	PATIALA	11KV	DS Divn. Model Town,	POS EAST TECH S/D PTA	0157FL09	Officer Colony	AMR	OK	31.03.2023	Category 1				3045	1200/577/1-1-1	6.339	NA	Director/D	
B.7455	South	PATIALA	11KV	DS Divn. Model Town,	POS EAST TECH S/D PTA	0157FL12	SULAR	AMR	OK	31.03.2023	Category 1				2066993	Not installed	6.493	NA	Director/D	
B.7456	South	PATIALA	11KV	DS Divn. Model Town,	POS EAST TECH S/D PTA	01570	Ghaluadi Gate	AMR	OK	31.03.2023	Category 1				43133	900-450/577/1-1-1	7.033	NA	Director/D	
B.7457	South	PATIALA	11KV	DS Divn. Model Town,	POS EAST TECH S/D PTA	0157FL11	Jain Ice	AMR	OK	31.03.2023	Category 1				43218	Not installed	8.386	NA	Director/D	
B.7458	South	PATIALA	11KV	DS Divn. Model Town,	POS EAST TECH S/D PTA	0157FL05	Palace Feeder	AMR	OK	31.03.2023	Category 1				3886	1200/577/1-1-1	8.953	NA	Director/D	
B.7459	South	PATIALA	11KV	DS Divn. Model Town,	POS EAST TECH S/D PTA	0157FL14	Jewan complex	AMR	OK	31.03.2023	Category 1				4187164	900-450/577/1-1-1	10.209	NA	Director/D	
B.7460	South	PATIALA	11KV	DS Divn. Model Town,	POS EAST TECH S/D PTA	0157FL08	Bahera Road	AMR	OK	31.03.2023	Category 1				3358	1200/577/1-1-1	11.495	NA	Director/D	
B.7461	South	PATIALA	11KV	DS Divn. Model Town,	POS EAST TECH S/D PTA	0156FL18	medical college	AMR	OK	31.03.2023	Category 1				16199503	Not installed	0.000	NA	Director/D	
B.7462	South	PATIALA	11KV	DS Divn. Model Town,	POS EAST TECH S/D PTA	0156G17	air force	AMR	OK	31.03.2023	Category 1				1439	Not installed	0.402	NA	Director/D	
B.7463	South	PATIALA	11KV	DS Divn. Model Town,	POS EAST TECH S/D PTA	0156G05	Rajindra Hospital	AMR	OK	31.03.2023	Category 1				77645	Not installed	1.232	NA	Director/D	
B.7464	South	PATIALA	11KV	DS Divn. Model Town,	POS EAST TECH S/D PTA	0156G04	NON AMR	OK	31.03.2023	Category 1				2997	Not installed	6.069	NA	Director/D		
B.7465	South	PATIALA	11KV	DS DIVN. NABHA	POS CITY S/D NABHA	8156FL04	P.S.L. NABHA	NON AMR	OK	31.03.2023	Category 4				11117020	Not installed	4.706	NA	Director/D	
B.7466	South	PATIALA	11KV	DS DIVN. NABHA	POS CITY S/D NABHA	8156FL10	11 KV PUDA ENCLAVE	AMR	OK	31.03.2023	Category 1				10281225	Not installed	12.926	NA	Director/D	
B.7467	South	PATIALA	11KV	DS DIVN. NABHA	POS CITY S/D NABHA	X240T01	Stn T. Nabha New	AMR	OK	31.03.2023	Substation Transformer				6	900-450/577/1-1-1	0.014	NA	Director/D	
B.7468	South	PATIALA	11KV	DS DIVN. NABHA	POS CITY S/D NABHA	X240FL03	Zila Jail	AMR	OK	31.03.2023	Category 4				3	900-450/577/1-1-1	0.238	NA	Director/D	
B.7469	South	PATIALA	11KV	DS DIVN. NABHA	POS CITY S/D NABHA	X240FL04	Mehra Gate	AMR	OK	31.03.2023	Category 1				4	900-450/577/1-1-1	3.555	NA	Director/D	
B.7470	South	PATIALA	11KV	DS DIVN. NABHA	POS CITY S/D NABHA	X240FL05	Veer Singh Colony	AMR	OK	31.03.2023	Category 1				5	900-450/577/1-1-1	3.854	NA	Director/D	
B.7471	South	PATIALA	11KV	DS DIVN. NABHA	POS CITY S/D NABHA	X240FL01	Thuni Road	AMR	OK	31.03.2023	Category 1				1	900-450/577/1-1-1	6.662	NA	Director/D	
B.7472	South	PATIALA	11KV	DS DIVN. NABHA	POS CITY S/D NABHA	X240FL02	Ajit Nagar	NON AMR	OK	31.03.2023	Category 1				2	900-450/577/1-1-1	9.930	NA	Director/D	
B.7473	South	PATIALA	11KV	DS DIVN. NABHA	POS CITY S/D NABHA	0170T001	Stn T. Old Nabha	AMR	OK	31.03.2023	Substation Transformer				12417416	Not installed	0.036	NA	Director/D	
B.7474	South	PATIALA	11KV	DS DIVN. NABHA	POS CITY S/D NABHA	0170FL05	JAIL ROAD	AMR	OK	31.03.2023	Category 1				5736	Not installed	1.211	NA	Director/D	
B.7475	South	PATIALA	11KV	DS DIVN. NABHA	POS CITY S/D NABHA	0170FL11	M.E.S.	AMR	OK	31.03.2023	Category 4				5654	1200/577/1-1-1	2.444	NA	Director/D	
B.7476	South	PATIALA	11KV	DS DIVN. NABHA	POS CITY S/D NABHA	0170FL10	HIRA MAHAL	AMR	OK	31.03.2023	Category 1				5654	1200/577/1-1-1	5.305	NA	Director/D	
B.7477	South	PATIALA	11KV	DS DIVN. NABHA	POS CITY S/D NABHA	0170FL08	CINEMA ROAD	AMR	OK	31.03.2023	Category 1				4221136	Not installed	5.350	NA	Director/D	
B.7478	South	PATIALA	11KV	DS DIVN. NABHA	POS CITY S/D NABHA	0170FL12	INDUSTRIAL	AMR	OK	31.03.2023	Category 1				5589	1200/577/1-1-1	5.760	NA	Director/D	
B.7479	South	PATIALA	11KV	DS DIVN. NABHA	POS CITY S/D NABHA	0170FL18	NABHA NO. 1	AMR	OK	31.03.2023	Category 1				5631	Not installed	9.078	NA	Director/D	
B.7480	South	PATIALA	11KV	DS DIVN. NABHA	POS CITY S/D NABHA	0170FL19	NABHA NO. 2	AMR	OK	31.03.2023	Category 1				6679934	Not installed	9.343	NA	Director/D	
B.7481	South	PATIALA	11KV	DS DIVN. NABHA	POS CITY S/D NABHA	0170FL02	ALCHAND GATE	AMR	OK	31.03.2023	Category 1				6679896	Not installed	9.489	NA	Director/D	
B.7482	South	PATIALA	11KV	DS DIVN. NABHA	POS CITY S/D NABHA	0170FL20	11 KV RADHA SWAMI ROAD	AMR	OK	31.03.2023	Category 1				5583	Not installed	10.113	NA	Director/D	
B.7483	South	PATIALA	11KV	DS DIVN. NABHA	POS CITY S/D NABHA	0170FL14	SBCH INDEPENDENT	AMR	OK	31.03.2023	Category 4				5587	Not installed	12.755	NA	Director/D	
B.7484	South	PATIALA	11KV	DS DIVN. NABHA	POS S/D AMARGARH	0169FL01	BHATTIAN	AMR	OK	31.03.2023	AP 3Phase 3Wire				8122601	Not installed	1.919	NA	Director/D	
B.7485	South	PATIALA	11KV	DS DIVN. NABHA	POS S/D AMARGARH	0169FL04	RAMPUR BHINDRAN	AMR	OK	31.03.2023	AP 3Phase 3Wire				8222603	Not installed	2.165	NA	Director/D	
B.7486	South	PATIALA	11KV	DS DIVN. NABHA	POS S/D AMARGARH	0169FL17	BLUK SEWA	NON AMR	OK	31.03.2023	AP 3Phase 3Wire				9140626	Not installed	2.276	NA	Director/D	
B.7487	South	PATIALA	11KV	DS DIVN. NABHA	POS S/D AMARGARH	0169FL14	J.P.S. SAMALINGARH-2	AMR	OK	31.03.2023	Category 5-UPS				11117103	Not installed	2.304	NA	Director/D	
B.7488	South	PATIALA	11KV	DS DIVN. NABHA	POS S/D AMARGARH	0169FL16	BHATTIAN KALAN	AMR	OK	31.03.2023	AP 3Phase 3Wire				9140714	Not installed	2.324	NA	Director/D	
B.7489	South	PATIALA	11KV	DS DIVN. NABHA	POS S/D AMARGARH	0169FL12	GIGA MAIRA	AMR	OK	31.03.2023	AP 3Phase 3Wire				8222602	Not installed	2.468	NA	Director/D	
B.7490	South	PATIALA	11KV	DS DIVN. NABHA	POS S/D AMARGARH	0172T001	Stn T. Amargarh	AMR	OK	31.03.2023	Substation Transformer				1168871	Not installed	0.029	NA	Director/D	
B.7491	South	PATIALA	11KV	DS DIVN. NABHA	POS S/D AMARGARH	0172FL24	BHR RURAL	AMR	OK	31.03.2023	AP 3Phase 3Wire				18665233	Not installed	1.393	NA	Director/D	
B.7492	South	PATIALA	11KV	DS DIVN. NABHA	POS S/D AMARGARH	0172FL25	BEAS GHAR	NON AMR	OK	31.03.2023	AP 3Phase 3Wire				11117275	Not installed	1.521	NA	Director/D	
B.7493	South	PATIALA	11KV	DS DIVN. NABHA	POS S/D AMARGARH	0172FL16	BHR	AMR	OK	31.03.2023	AP 3Phase 3Wire				11117274	Not installed	1.674	NA	Director/D	
B.7494	South	PATIALA	11KV	DS DIVN. NABHA	POS S/D AMARGARH	0172FL13	SALEMUR	AMR	OK	31.03.2023	AP 3Phase 3Wire				6740701	Not installed	1.832	NA	Director/D	
B.7495	South	PATIALA	11KV	DS DIVN. NABHA	POS S/D AMARGARH	0172FL21	Nangal Road	AMR	OK	31.03.2023	AP 3Phase 3Wire				16194446	Not installed	1.994	NA	Director/D	
B.7496	South	PATIALA	11KV	DS DIVN. NABHA	POS S/D AMARGARH	0172FL19	DP RURAL	AMR	OK	31.03.2023	AP 3Phase 3Wire				16194445	Not installed	2.015	NA	Director/D	
B.7497	South	PATIALA	11KV	DS DIVN. NABHA	POS S/D AMARGARH	0172FL02	DHALA	AMR	OK	31.03.2023	AP 3Phase 3Wire				9140705	Not installed	2.023	NA	Director/D	
B.7498	South	PATIALA	11KV	DS DIVN. NABHA	POS S/D AMARGARH	0172FL17	MUHLA	AMR	OK	31.03.2023	AP 3Phase 3Wire				16193486	Not installed	2.197	NA	Director/D	
B.7499	South	PATIALA	11KV	DS DIVN. NABHA	POS S/D AMARGARH	0172FL12	JHAL	AMR	OK	31.03.2023	AP 3Phase 3Wire				9140756	Not installed	2.219	NA	Director/D	
B.7500	South	PATIALA	11KV	DS DIVN. NABHA	POS S/D AMARGARH	0172FL03	BAGRAN	AMR	OK	31.03.2023	AP 3Phase 3Wire				9140757	Not installed	2.222	NA	Director/D	
B.7501	South	PATIALA	11KV	DS DIVN. NABHA	POS S/D AMARGARH	0172FL07	Kheri	AMR	OK	31.03.2023	AP 3Phase 3Wire				9140625	Not installed	2.256	NA	Director/D	
B.7502	South	PATIALA	11KV	DS DIVN. NABHA	POS S/D AMARGARH	0172FL06	LAMGRAN	AMR	OK	31.03.2023	AP 3Phase 3Wire				9140759	Not installed	2.328	NA	Director/D	
B.7503	South	PATIALA	11KV	DS DIVN. NABHA	POS S/D AMARGARH	0172FL18	NP RURAL	AMR	OK	31.03.2023	AP 3Phase 3Wire				16193489	Not installed	2.359	NA	Director/D	
B.7504	South	PATIALA	11KV	DS DIVN. NABHA	POS S/D AMARGARH	0172FL20	SAMPURANGARH	AMR	OK	31.03.2023	AP 3Phase 3Wire				16194421	Not installed	2.452	NA	Director/D	
B.7505	South	PATIALA	11KV	DS DIVN. NABHA	POS S/D AMARGARH	0172FL05	RAMPUR CHHANA	NON AMR	OK	31.03.2023	AP 3Phase 3Wire				9140624	Not installed	2.739	NA	Director/D	
B.7506	South	PATIALA	11KV	DS DIVN. NABHA	POS S/D AMARGARH	0172FL27	UPS Mulabaddha	AMR	OK	31.03.2023	Category 5-UPS				4953	Not installed	3.335	NA	Director/D	
B.7507	South	PATIALA	11KV	DS DIVN. NABHA	POS S/D AMARGARH	0172FL														

S.No	Zone	Circle	Voltage Level (kVA)	Division (kVA)	Sub-Division (kVA)	Feeder Metering Status (Metered/unmetered/AMR/AMI)	Status of Meter (Functional/Non-Functional)	Metering Date (Date of last actual meter reading/communication)	Feeder Type (Agr/Industrial/Mixed)	Status of Communication			Period from 01.04.2021 to 31.03.2022				Sales	Remarks (Source of data)
										% data received through automatically if feeder AMR/AMI	Number of hours when meter was unable to communicate in overall	Total Number of hours in the period	Meter S.No	CT/PT ratio	Import (kU)	Export (kU)		
B.7536	South	PATIALA	11KV	D5 DIVN. NABHA	D5 S/D DHINGI	D197F06	KAKRALA (Achal)	AMR	OK	31.03.2023	AP 3Phase 3Wire			33400	900-450/577/1-1-1	1.565	NA	Director/D
B.7537	South	PATIALA	11KV	D5 DIVN. NABHA	D5 S/D DHINGI	D197F08	CHATTI PEER	AMR	OK	31.03.2023	AP 3Phase 3Wire			1519378	900-450/577/1-1-1	1.789	NA	Director/D
B.7538	South	PATIALA	11KV	D5 DIVN. NABHA	D5 S/D DHINGI	D197F02	Achal	NON AMR	OK	31.03.2023	AP 3Phase 3Wire			23772	900-450/577/1-1-1	2.284	NA	Director/D
B.7539	South	PATIALA	11KV	D5 DIVN. NABHA	D5 S/D DHINGI	D197F07	KASHMIRI	AMR	OK	31.03.2023	AP 3Phase 3Wire			345223	900-450/577/1-1-1	2.383	NA	Director/D
B.7540	South	PATIALA	11KV	D5 DIVN. NABHA	D5 S/D DHINGI	D197F01	SADHCHERI	NON AMR	OK	31.03.2023	AP 3Phase 3Wire			23572	900-450/577/1-1-1	2.461	NA	Director/D
B.7541	South	PATIALA	11KV	D5 DIVN. NABHA	D5 S/D DHINGI	D169D01	Stn T.F. Samundgarh	AMR	OK	31.03.2023	Substation Transformer			16877	900-450/577/1-1-1	0.212	NA	Director/D
B.7542	South	PATIALA	11KV	D5 DIVN. NABHA	D5 S/D DHINGI	D169F06	TUNGA	AMR	OK	31.03.2023	AP 3Phase 3Wire			33991	Not installed	1.231	NA	Director/D
B.7543	South	PATIALA	11KV	D5 DIVN. NABHA	D5 S/D DHINGI	D169F19	CHATHE	AMR	OK	31.03.2023	AP 3Phase 3Wire			36952	Not installed	1.268	NA	Director/D
B.7544	South	PATIALA	11KV	D5 DIVN. NABHA	D5 S/D DHINGI	D169F18	TUNGA KOTHE	AMR	OK	31.03.2023	AP 3Phase 3Wire			34228	Not installed	1.446	NA	Director/D
B.7545	South	PATIALA	11KV	D5 DIVN. NABHA	D5 S/D DHINGI	D169F02	SAKONAN	NON AMR	OK	31.03.2023	AP 3Phase 3Wire			8222794	Not installed	2.359	NA	Director/D
B.7546	South	PATIALA	11KV	D5 DIVN. NABHA	D5 S/D DHINGI	D169F20	UJPS TUNGA	AMR	OK	31.03.2023	Category 5-UJPS			15196065	Not installed	4.620	NA	Director/D
B.7547	South	PATIALA	11KV	D5 DIVN. NABHA	D5 S/D DHINGI	D117F00	GHANIWAL	NON AMR	OK	31.03.2023	AP 3Phase 3Wire			9141079	900-450/5	1.664	NA	Director/D
B.7548	South	PATIALA	11KV	D5 DIVN. NABHA	D5 S/D DHINGI	D184D01	Stn T.F. Gurditpura	AMR	OK	31.03.2023	Substation Transformer			2792044	Not installed	0.018	NA	Director/D
B.7549	South	PATIALA	11KV	D5 DIVN. NABHA	D5 S/D DHINGI	D184F17	UDHA	AMR	OK	31.03.2023	AP 3Phase 3Wire			3344	Not installed	1.123	NA	Director/D
B.7550	South	PATIALA	11KV	D5 DIVN. NABHA	D5 S/D DHINGI	D184F11	GURDITPURA CAT. 1	AMR	OK	31.03.2023	Category 1			9153979	Not installed	1.907	NA	Director/D
B.7551	South	PATIALA	11KV	D5 DIVN. NABHA	D5 S/D DHINGI	D184F05	NEW GURDITPURA	AMR	OK	31.03.2023	AP 3Phase 3Wire			9140621	Not installed	1.867	NA	Director/D
B.7552	South	PATIALA	11KV	D5 DIVN. NABHA	D5 S/D DHINGI	D184F18	GHANIWAL (Gurditpura)	AMR	OK	31.03.2023	AP 3Phase 3Wire			16199599	Not installed	2.172	NA	Director/D
B.7553	South	PATIALA	11KV	D5 DIVN. NABHA	D5 S/D DHINGI	D184F16	GALWATTI	AMR	OK	31.03.2023	AP 3Phase 3Wire			11111	Not installed	2.198	NA	Director/D
B.7554	South	PATIALA	11KV	D5 DIVN. NABHA	D5 S/D DHINGI	D184F04	BABARPUR	AMR	OK	31.03.2023	AP 3Phase 3Wire			9140622	Not installed	2.226	NA	Director/D
B.7555	South	PATIALA	11KV	D5 DIVN. NABHA	D5 S/D DHINGI	D184F03	GUJHARHER	AMR	OK	31.03.2023	AP 3Phase 3Wire			9140623	Not installed	2.263	NA	Director/D
B.7556	South	PATIALA	11KV	D5 DIVN. NABHA	D5 S/D DHINGI	D184F02	DODA	AMR	OK	31.03.2023	AP 3Phase 3Wire			6740767	Not installed	2.297	NA	Director/D
B.7557	South	PATIALA	11KV	D5 DIVN. NABHA	D5 S/D DHINGI	D184F19	TODARWAL	AMR	OK	31.03.2023	AP 3Phase 3Wire			16199434	Not installed	2.412	NA	Director/D
B.7558	South	PATIALA	11KV	D5 DIVN. NABHA	D5 S/D DHINGI	D184F13	DODA No 2	AMR	OK	31.03.2023	AP 3Phase 3Wire			33637	Not installed	2.472	NA	Director/D
B.7559	South	PATIALA	11KV	D5 DIVN. NABHA	D5 S/D DHINGI	D184F01	HARIGARH	NON AMR	OK	31.03.2023	AP 3Phase 3Wire			15193882	Not installed	2.501	NA	Director/D
B.7560	South	PATIALA	11KV	D5 DIVN. NABHA	D5 S/D DHINGI	D184F10	Bhlowal	AMR	OK	31.03.2023	AP 3Phase 3Wire			9534587	Not installed	2.517	NA	Director/D
B.7561	South	PATIALA	11KV	D5 DIVN. NABHA	D5 S/D DHINGI	D184F14	UJPS Babarpur	AMR	OK	31.03.2023	Category 5-UJPS			125478	400-200/5	5.123	NA	Director/D
B.7562	South	PATIALA	11KV	D5 DIVN. NABHA	D5 S/D DHINGI	D184F06	GURDITPURA UJPS	AMR	OK	31.03.2023	Category 5-UJPS			6675936	Not installed	5.535	NA	Director/D
B.7563	South	PATIALA	11KV	D5 DIVN. NABHA	D5 S/D DHINGI	D184F07	INDUSTRIAL	AMR	OK	31.03.2023	Category 1			7336737	Not installed	5.645	NA	Director/D
B.7564	South	PATIALA	11KV	D5 DIVN. NABHA	D5 S/D DHINGI	D170F01	DHINGI	AMR	OK	31.03.2023	AP 3Phase 3Wire			43191	1200/577/1-1-1	2.325	NA	Director/D
B.7565	South	PATIALA	11KV	D5 DIVN. NABHA	D5 S/D DHINGI	D170F16	GURDITPURA	AMR	OK	31.03.2023	AP 3Phase 3Wire			43148	1200/577/1-1-1	4.045	NA	Director/D
B.7566	South	PATIALA	11KV	D5 DIVN. NABHA	D5 S/D GHAMRODA	D122F16	RCHTI CHHMANNA	AMR	OK	31.03.2023	AP 3Phase 3Wire			124589	400-200/5-5	1.360	NA	Director/D
B.7567	South	PATIALA	11KV	D5 DIVN. NABHA	D5 S/D GHAMRODA	D122F08	KANOUR	AMR	OK	31.03.2023	AP 3Phase 3Wire			8222912	1200-600/5	1.795	NA	Director/D
B.7568	South	PATIALA	11KV	D5 DIVN. NABHA	D5 S/D GHAMRODA	D122F02	PEONI	AMR	OK	31.03.2023	AP 3Phase 3Wire			125478	400-200/5-5	1.786	NA	Director/D
B.7569	South	PATIALA	11KV	D5 DIVN. NABHA	D5 S/D GHAMRODA	D122F11	KHURD	AMR	OK	31.03.2023	AP 3Phase 3Wire			124598	400-200/5-5	1.797	NA	Director/D
B.7570	South	PATIALA	11KV	D5 DIVN. NABHA	D5 S/D GHAMRODA	D122F07	BIRDWAL	AMR	OK	31.03.2023	AP 3Phase 3Wire			8222913	1200-600/5	1.836	NA	Director/D
B.7571	South	PATIALA	11KV	D5 DIVN. NABHA	D5 S/D GHAMRODA	D122F13	LUBANA(Agouli)	AMR	OK	31.03.2023	AP 3Phase 3Wire			8222911	1200-600/5	1.907	NA	Director/D
B.7572	South	PATIALA	11KV	D5 DIVN. NABHA	D5 S/D GHAMRODA	D122F10	UJPS DHANGLA	AMR	OK	31.03.2023	Category 5-UJPS			125478	400-200/5	2.413	NA	Director/D
B.7573	South	PATIALA	11KV	D5 DIVN. NABHA	D5 S/D GHAMRODA	D122F01	ALLOWAL	AMR	OK	31.03.2023	AP 3Phase 3Wire			10282842	Not installed	1.311	NA	Director/D
B.7574	South	PATIALA	11KV	D5 DIVN. NABHA	D5 S/D GHAMRODA	D196F02	DHANOUR	AMR	OK	31.03.2023	AP 3Phase 3Wire			10282852	Not installed	1.516	NA	Director/D
B.7575	South	PATIALA	11KV	D5 DIVN. NABHA	D5 S/D GHAMRODA	D196F08	ALLOWAL CAT. 1	AMR	OK	31.03.2023	Category 1			12093450	Not installed	1.809	NA	Director/D
B.7576	South	PATIALA	11KV	D5 DIVN. NABHA	D5 S/D GHAMRODA	D196F04	KANSUHA	AMR	OK	31.03.2023	AP 3Phase 3Wire			10282932	Not installed	2.050	NA	Director/D
B.7577	South	PATIALA	11KV	D5 DIVN. NABHA	D5 S/D GHAMRODA	D196F03	LAUT	AMR	OK	31.03.2023	AP 3Phase 3Wire			10282985	Not installed	2.056	NA	Director/D
B.7578	South	PATIALA	11KV	D5 DIVN. NABHA	D5 S/D GHAMRODA	D196F07	ANODA	AMR	OK	31.03.2023	AP 3Phase 3Wire			23371	Not installed	2.318	NA	Director/D
B.7579	South	PATIALA	11KV	D5 DIVN. NABHA	D5 S/D GHAMRODA	D197F13	SIMBRO	AMR	OK	31.03.2023	AP 3Phase 3Wire			16199496	Not installed	2.659	NA	Director/D
B.7580	South	PATIALA	11KV	D5 DIVN. NABHA	D5 S/D GHAMRODA	D196F05	UJPS ALLOWAL	AMR	OK	31.03.2023	Category 5-UJPS			10282889	Not installed	2.693	NA	Director/D
B.7581	South	PATIALA	11KV	D5 DIVN. NABHA	D5 S/D GHAMRODA	D196F10	Stn T.F. Hiana Kalan	NON AMR	OK	31.03.2023	Category 5-UJPS			23416	Not installed	4.396	NA	Director/D
B.7582	South	PATIALA	11KV	D5 DIVN. NABHA	D5 S/D GHAMRODA	D200D01	UJPS HANA KALAN	NON AMR	OK	31.03.2023	Substation Transformer			9140707	400-200/5-5	0.025	NA	Director/D
B.7583	South	PATIALA	11KV	D5 DIVN. NABHA	D5 S/D GHAMRODA	D200F08	ROHTA	NON AMR	OK	31.03.2023	AP 3Phase 3Wire			1257454	400-200/5-5	1.176	NA	Director/D
B.7584	South	PATIALA	11KV	D5 DIVN. NABHA	D5 S/D GHAMRODA	D200F03	ROHTI KHAS	NON AMR	OK	31.03.2023	AP 3Phase 3Wire			1257378	400-200/5-5	1.525	NA	Director/D
B.7585	South	PATIALA	11KV	D5 DIVN. NABHA	D5 S/D GHAMRODA	D200F04	LUBANA	NON AMR	OK	31.03.2023	AP 3Phase 3Wire			13190542	400-200/5-5	1.696	NA	Director/D
B.7586	South	PATIALA	11KV	D5 DIVN. NABHA	D5 S/D GHAMRODA	D200F06	Laloda	NON AMR	OK	31.03.2023	AP 3Phase 3Wire			12527346	400-200/5-5	1.822	NA	Director/D
B.7587	South	PATIALA	11KV	D5 DIVN. NABHA	D5 S/D GHAMRODA	D200F01	HIANA KALAN	NON AMR	OK	31.03.2023	AP 3Phase 3Wire			13190517	400-200/5-5	1.826	NA	Director/D
B.7588	South	PATIALA	11KV	D5 DIVN. NABHA	D5 S/D GHAMRODA	D200F02	HIANA KHURD	NON AMR	OK	31.03.2023	AP 3Phase 3Wire			12527393	400-200/5-5	2.022	NA	Director/D
B.7589	South	PATIALA	11KV	D5 DIVN. NABHA	D5 S/D GHAMRODA	D200F09	NON AMR	OK	31.03.2023	AP 3Phase 3Wire			23416	400-200/5-5	2.169	NA	Director/D	
B.7590	South	PATIALA	11KV	D5 DIVN. NABHA	D5 S/D GHAMRODA	D200F05	ROHTI MORAN	NON AMR	OK	31.03.2023	AP 3Phase 3Wire			23464	400-200/5-5	2.305	NA	Director/D
B.7591	South	PATIALA	11KV	D5 DIVN. NABHA	D5 S/D GHAMRODA	D200F07	UJPS ROHTA SAHIB	AMR	OK	31.03.2023	Category 5-UJPS			23373	400-200/5-5	8.700	NA	Director/D
B.7592	South	PATIALA	11KV	D5 DIVN. NABHA	D5 S/D GHAMRODA	D170F23	MEHS RURAL	AMR	OK	31.03.2023	AP 3Phase 3Wire			3606	Not installed	1.057	NA	Director/D
B.7593	South	PATIALA	11KV	D5 DIVN. NABHA	D5 S/D GHAMRODA	D170F03	GHAMROUDA	AMR	OK	31.03.2023	AP 3Phase 3Wire			9140604	Not installed	1.160	NA	Director/D
B.7594	South	PATIALA	11KV	D5 DIVN. NABHA	D5 S/D GHAMRODA	D170F04	ROHTA BASTA	AMR	OK	31.03.2023	AP 3Phase 3Wire			9140605	Not installed	1.056	NA	Director/D
B.7595	South	PATIALA	11KV	D5 DIVN. NABHA	D5 S/D GHAMRODA	D170F09	SHAMLA	AMR	OK	31.03.2023	AP 3Phase 3Wire			5657	Not installed	1.920	NA	Director/D
B.7596	South	PATIALA	11KV	D5 DIVN. NABHA	D5 S/D GHAMRODA	D170F13	UJPS NABHA NO. 2	AMR	OK	31.03.2023	Category 5-UJPS			5649	Not installed	2.757	NA	Director/D
B.7597	South	PATIALA	11KV	D5 DIVN. NABHA	D5 S/D GHAMRODA	D170F21	PREET AGRO	AMR	OK	31.03.2023	Category 4			5635	1200/577/1-1-1	4.319	NA	Director/D
B.7598	South	PATIALA	11KV	D5 DIVN. NABHA	D5 S/D GHAMRODA	D158F07	11 KV DHANOUR	AMR	OK	31.03.2023	AP 3Phase 3Wire			9140733	Not installed	0.235	NA	Director/D
B.7599	South	PATIALA	11KV	D5 DIVN. NABHA	D5 S/D GHAMRODA	D158F12	GHAMROUDA NO 2	AMR	OK	31.03.2023	AP 3Phase 3Wire			9140706	Not installed	1.596	NA	Director/D
B.7600	South	PATIALA	11KV	D5 DIVN. NABHA	D5 S/D GHAMRODA	D158F08	11 KV SANGATPURA	AMR	OK	31.03.2023	AP 3Phase 3Wire			9140731	Not installed	2.443	NA	Director/D
B.7601	South	PATIALA	11KV	D5 DIVN. NABHA	D5 S/D GHAMRODA	D158F01	11 KV KINODA	AMR	OK	31.03.2023	AP 3Phase 3Wire			9140710	Not installed	2.502	NA	Director/D
B.7602	South	PATIALA	11KV	D5 DIVN. NABHA	D5 S/D GHAMRODA	D158F09	MANDOUR	AMR	OK	31.03.2023	AP 3Phase 3Wire			1247934	Not installed	2.555	NA	Director/D
B.7603	South	PATIALA	11KV	D5 DIVN. NABHA	D5 S/D GHAMRODA	D158F15	Souja	AMR	OK	31.03.2023	AP 3Phase 3Wire			2068093	Not installed	2.594	NA	Director/D
B.7604	South	PATIALA	11KV	D5 DIVN. NABHA	D5 S/D GHAMRODA	D158F19	UJPS LALAUDA	AMR	OK	31.03.2023	Category 5-UJPS			3571	Not installed	2.897		

S.No	Zone	Circle	Voltage Level (kVA)	Division (kVA)	Sub-Division (kVA)	Feeder ID	Feeder Name	Feeder Metering Status (Metered/unmetered/AMTR/RE)	Status of Meter (Functional/Non-Functional)	Metering Date (Date of last actual meter reading/communication)	Feeder Type (Agr/Industrial/Mixed)	Status of Communication			Period from 01.04.2021 to 31.03.2022				Sales	Remarks (Source of data)
												% Data received through automatically if feeder AMR/AMI	Number of hours when meter was unable to communicate in overall	Total Number of hours in the period	Meter S.No	CT/PT ratio	Import (kWh)	Export (kWh)		
B.7633	South	PATIALA	11KV	DS DIVN. NABHA	DS S/U S/D NABHA	D069F07	KOTKALAN	AMR	OK	31.03.2023	AP 3Phase 3Wire				9140705	Not installed	1.766	NA	Director/D	
B.7634	South	PATIALA	11KV	DS DIVN. NABHA	DS S/U S/D NABHA	D026F14	LOHAR NABHA	AMR	OK	31.03.2023	AP 3Phase 3Wire				23732	900-450/577/1-1	2.037	NA	Director/D	
B.7635	South	PATIALA	11KV	DS DIVN. NABHA	DS S/U S/D NABHA	D026F106	SUNKEE NO. 02	AMR	OK	31.03.2023	AP 3Phase 3Wire				4221164	900-450/5	2.482	NA	Director/D	
B.7636	South	PATIALA	11KV	DS DIVN. NABHA	DS S/U S/D NABHA	D026F15	BIBBER	NON AMR	OK	31.03.2023	AP 3Phase 3Wire				235474	900-450/577/1-1	2.662	NA	Director/D	
B.7637	South	PATIALA	11KV	DS DIVN. NABHA	DS S/U S/D NABHA	D018F09	VAZZEDPUR	AMR	OK	31.03.2023	AP 3Phase 3Wire				9534519	Not installed	2.190	NA	Director/D	
B.7638	South	PATIALA	11KV	DS DIVN. NABHA	DS S/U S/D NABHA	D018F12	KAUL	AMR	OK	31.03.2023	AP 3Phase 3Wire				33474	Not installed	2.550	NA	Director/D	
B.7639	South	PATIALA	11KV	DS DIVN. NABHA	DS S/U S/D NABHA	D0170F07	KHOIKH	AMR	OK	31.03.2023	AP 3Phase 3Wire				9140712	Not installed	2.322	NA	Director/D	
B.7640	South	PATIALA	11KV	DS DIVN. NABHA	DS S/U S/D NABHA	D0170F15	CHODHARI MAJRA	AMR	OK	31.03.2023	AP 3Phase 3Wire				5620	Not installed	2.399	NA	Director/D	
B.7641	South	PATIALA	11KV	DS DIVN. NABHA	DS S/U S/D NABHA	D0170F22	UPS BHOJOMAJRI	AMR	OK	31.03.2023	Category 5-UPS				43137	1200/577/1-1	6.265	NA	Director/D	
B.7642	South	PATIALA	11KV	DS DIVN. NABHA	DS S/U S/D NABHA	D0170F06	UPS NABHA NO.1	AMR	OK	31.03.2023	Category 5-UPS				4293	Not installed	11.302	NA	Director/D	
B.7643	South	PATIALA	11KV	DS DIVN. NABHA	DS S/U S/D NABHA	D0195T01	Shn T.F Sarajpur	AMR	OK	31.03.2023	Substation Transformer				10051662	1200/577/1-1	0.030	NA	Director/D	
B.7644	South	PATIALA	11KV	DS DIVN. NABHA	DS S/U S/D NABHA	D0195F07	SURAJPUR CAT. 1	AMR	OK	31.03.2023	Category 1				10273800	1200/577/1-1	0.645	NA	Director/D	
B.7645	South	PATIALA	11KV	DS DIVN. NABHA	DS S/U S/D NABHA	D0195F14	SURAJPUR	AMR	OK	31.03.2023	AP 3Phase 3Wire				23532	1200/577/1-1	1.319	NA	Director/D	
B.7646	South	PATIALA	11KV	DS DIVN. NABHA	DS S/U S/D NABHA	D0195F08	NIRMANA	AMR	OK	31.03.2023	AP 3Phase 3Wire				3235	1200/577/1-1	1.330	NA	Director/D	
B.7647	South	PATIALA	11KV	DS DIVN. NABHA	DS S/U S/D NABHA	D0195F04	SOJJA	AMR	OK	31.03.2023	AP 3Phase 3Wire				11116939	1200/577/1-1	1.600	NA	Director/D	
B.7648	South	PATIALA	11KV	DS DIVN. NABHA	DS S/U S/D NABHA	D0195F13	AGETI	AMR	OK	31.03.2023	AP 3Phase 3Wire				23274	1200/577/1-1	1.663	NA	Director/D	
B.7649	South	PATIALA	11KV	DS DIVN. NABHA	DS S/U S/D NABHA	D0195F12	DEWANGARH	AMR	OK	31.03.2023	AP 3Phase 3Wire				11116714	1200/577/1-1	2.044	NA	Director/D	
B.7650	South	PATIALA	11KV	DS DIVN. NABHA	DS S/U S/D NABHA	D0195F02	BANERA NO. 2	AMR	OK	31.03.2023	AP 3Phase 3Wire				3204	1200/577/1-1	2.213	NA	Director/D	
B.7651	South	PATIALA	11KV	DS DIVN. NABHA	DS S/U S/D NABHA	D0195F01	UPS SURAJPUR	AMR	OK	31.03.2023	Category 5-UPS				13190028	1200/577/1-1	6.474	NA	Director/D	
B.7652	South	PATIALA	11KV	DS DIVN. RAIPURA	DS CITY S/D RAIPURA	B152F01	PILHANI	AMR	OK	31.03.2023	AP 3Phase 3Wire				669913	Not installed	1.960	NA	Director/D	
B.7653	South	PATIALA	11KV	DS DIVN. RAIPURA	DS CITY S/D RAIPURA	B152F09	MANDVAL	AMR	OK	31.03.2023	AP 3Phase 3Wire				27964	Not installed	2.322	NA	Director/D	
B.7654	South	PATIALA	11KV	DS DIVN. RAIPURA	DS CITY S/D RAIPURA	B152F06	SEHRA2	AMR	OK	31.03.2023	AP 3Phase 3Wire				9164368	Not installed	2.519	NA	Director/D	
B.7655	South	PATIALA	11KV	DS DIVN. RAIPURA	DS CITY S/D RAIPURA	B152F02	SEHRA1	AMR	OK	31.03.2023	AP 3Phase 3Wire				6740719	Not installed	3.459	NA	Director/D	
B.7656	South	PATIALA	11KV	DS DIVN. RAIPURA	DS CITY S/D RAIPURA	B152F03	Koti - 2	AMR	OK	31.03.2023	AP 3Phase 3Wire				9154259	Not installed	3.851	NA	Director/D	
B.7657	South	PATIALA	11KV	DS DIVN. RAIPURA	DS CITY S/D RAIPURA	B152F04	UPS	AMR	OK	31.03.2023	Category 5-UPS				9154279	Not installed	5.935	NA	Director/D	
B.7658	South	PATIALA	11KV	DS DIVN. RAIPURA	DS CITY S/D RAIPURA	B152F12	ups silkhanli	AMR	OK	31.03.2023	Category 5-UPS				3526	Not installed	8.290	NA	Director/D	
B.7659	South	PATIALA	11KV	DS DIVN. RAIPURA	DS CITY S/D RAIPURA	B152F07	BSNL	AMR	OK	31.03.2023	Category 1				9154282	Not installed	11.744	NA	Director/D	
B.7660	South	PATIALA	11KV	DS DIVN. RAIPURA	DS CITY S/D RAIPURA	B152F08	SARHIND ROAD	AMR	OK	31.03.2023	Category 1				9154289	Not installed	13.216	NA	Director/D	
B.7661	South	PATIALA	11KV	DS DIVN. RAIPURA	DS CITY S/D RAIPURA	B151F08	Nagawan	AMR	OK	31.03.2023	AP 3Phase 3Wire				16194417	400-200/5	1.109	NA	Director/D	
B.7662	South	PATIALA	11KV	DS DIVN. RAIPURA	DS CITY S/D RAIPURA	B151F09	MANOHAR PACKERS	AMR	OK	31.03.2023	Category 4				4001	400-200/5	3.054	NA	Director/D	
B.7663	South	PATIALA	11KV	DS DIVN. RAIPURA	DS CITY S/D RAIPURA	B151F03	SANDHARI	AMR	OK	31.03.2023	AP 3Phase 3Wire				16198484	400-200/5	2.115	NA	Director/D	
B.7664	South	PATIALA	11KV	DS DIVN. RAIPURA	DS CITY S/D RAIPURA	B151F04	TP	AMR	OK	31.03.2023	Category 2				16194443	400-200/5	9.305	NA	Director/D	
B.7665	South	PATIALA	11KV	DS DIVN. RAIPURA	DS CITY S/D RAIPURA	B151F07	ABIS	AMR	OK	31.03.2023	Category 2				3622	400-200/5	10.132	NA	Director/D	
B.7666	South	PATIALA	11KV	DS DIVN. RAIPURA	DS CITY S/D RAIPURA	B151F02	UPS SANDARI	AMR	OK	31.03.2023	Category 5-UPS				16198480	400-200/5	14.533	NA	Director/D	
B.7667	South	PATIALA	11KV	DS DIVN. RAIPURA	DS CITY S/D RAIPURA	D018F14	suron	AMR	OK	31.03.2023	AP 3Phase 3Wire				822809	600/577/1-1	1.299	NA	Director/D	
B.7668	South	PATIALA	11KV	DS DIVN. RAIPURA	DS CITY S/D RAIPURA	D018F03	NEW DHARMGARH	AMR	OK	31.03.2023	AP 3Phase 3Wire				2068606	Not installed	1.712	NA	Director/D	
B.7669	South	PATIALA	11KV	DS DIVN. RAIPURA	DS CITY S/D RAIPURA	D018F05	LOHANGHERI	AMR	OK	31.03.2023	AP 3Phase 3Wire				2067761	600/577/1-1	2.525	NA	Director/D	
B.7670	South	PATIALA	11KV	DS DIVN. RAIPURA	DS CITY S/D RAIPURA	D018F06	HASSANPUR	AMR	OK	31.03.2023	AP 3Phase 3Wire				9140619	600/577/1-1	2.545	NA	Director/D	
B.7671	South	PATIALA	11KV	DS DIVN. RAIPURA	DS CITY S/D RAIPURA	D018F11	DHARAMGARH URBAN	AMR	OK	31.03.2023	Category 2				9154083	600/577/1-1	3.639	NA	Director/D	
B.7672	South	PATIALA	11KV	DS DIVN. RAIPURA	DS CITY S/D RAIPURA	D018F09	BATHONIA	AMR	OK	31.03.2023	Category 5-UPS				36889	600/577/1-1	8.577	NA	Director/D	
B.7673	South	PATIALA	11KV	DS DIVN. RAIPURA	DS CITY S/D RAIPURA	D018F15	UPS AALMAJRA	Not available	OK	31.03.2023	Category 5-UPS				3951	Not installed	8.756	NA	Director/D	
B.7674	South	PATIALA	6KV	DS DIVN. RAIPURA	DS CITY S/D RAIPURA	D018F11	NV DISTILLERY	Not available	OK	31.03.2023	Category 4				Not available	Not available	1.528	NA	Director/D	
B.7675	South	PATIALA	6KV	DS DIVN. RAIPURA	DS CITY S/D RAIPURA	B152F12	BODAL CHEMICAL SEIL	AMR	OK	31.03.2023	Category 4				Not available	Not available	186.804	NA	Director/D	
B.7676	South	PATIALA	11KV	DS DIVN. RAIPURA	DS CITY S/D RAIPURA	D0168F04	MARDAPUR	AMR	OK	31.03.2023	AP 3Phase 3Wire				9140654	Not installed	3.730	NA	Director/D	
B.7677	South	PATIALA	11KV	DS DIVN. RAIPURA	DS CITY S/D RAIPURA	D0168F02	SYL	AMR	OK	31.03.2023	Category 5-UPS				2066626	Not installed	11.988	NA	Director/D	
B.7678	South	PATIALA	11KV	DS DIVN. RAIPURA	DS CITY S/D RAIPURA	D0165F12	STATION T/F 66 KV OLD GRID	AMR	OK	31.03.2023	Category 4				6740774	Not installed	0.038	NA	Director/D	
B.7679	South	PATIALA	11KV	DS DIVN. RAIPURA	DS CITY S/D RAIPURA	D0165F16	A.P JAIN HOSPITAL	AMR	OK	31.03.2023	Category 4				10273742	1200-600/5	0.502	NA	Director/D	
B.7680	South	PATIALA	11KV	DS DIVN. RAIPURA	DS CITY S/D RAIPURA	D0165F05	Ward 02/05	AMR	OK	31.03.2023	Category 1				14990165	Not installed	1.026	NA	Director/D	
B.7681	South	PATIALA	11KV	DS DIVN. RAIPURA	DS CITY S/D RAIPURA	D0165F06	DHARMGARH	AMR	OK	31.03.2023	AP 3Phase 3Wire				9140600	Not installed	2.310	NA	Director/D	
B.7682	South	PATIALA	11KV	DS DIVN. RAIPURA	DS CITY S/D RAIPURA	D0165F07	KOALI	AMR	OK	31.03.2023	AP 3Phase 3Wire				9140579	1200-600/5	2.783	NA	Director/D	
B.7683	South	PATIALA	11KV	DS DIVN. RAIPURA	DS CITY S/D RAIPURA	D0165F15	INDUSTRIAL ESTATE	AMR	OK	31.03.2023	Category 2				4286	Not installed	2.830	NA	Director/D	
B.7684	South	PATIALA	11KV	DS DIVN. RAIPURA	DS CITY S/D RAIPURA	D0165F20	Arya Samaj	AMR	OK	31.03.2023	Category 1				37013	1200-600/5	3.443	NA	Director/D	
B.7685	South	PATIALA	11KV	DS DIVN. RAIPURA	DS CITY S/D RAIPURA	D0165F01	SANDIKHERI	AMR	OK	31.03.2023	AP 3Phase 3Wire				9140599	1200-600/5	3.776	NA	Director/D	
B.7686	South	PATIALA	11KV	DS DIVN. RAIPURA	DS CITY S/D RAIPURA	D0165F03	MANAUR	AMR	OK	31.03.2023	Category 1				6761973	Not installed	4.489	NA	Director/D	
B.7687	South	PATIALA	11KV	DS DIVN. RAIPURA	DS CITY S/D RAIPURA	D0165F17	SINGH SABHA ROAD	AMR	OK	31.03.2023	Category 1				580702	1200-600/5	9.263	NA	Director/D	
B.7688	South	PATIALA	11KV	DS DIVN. RAIPURA	DS CITY S/D RAIPURA	D0165F18	MOHINDER GANJ	AMR	OK	31.03.2023	Category 1				583703	1200-600/5	10.172	NA	Director/D	
B.7689	South	PATIALA	11KV	DS DIVN. RAIPURA	DS CITY S/D RAIPURA	D0165F14	PATIALA ROAD	AMR	OK	31.03.2023	Category 1				16199444	Not installed	10.381	NA	Director/D	
B.7690	South	PATIALA	11KV	DS DIVN. RAIPURA	DS CITY S/D RAIPURA	D0165F19	KK SCHOOL ROAD	AMR	OK	31.03.2023	Category 1				579591	1200-600/5	10.386	NA	Director/D	
B.7691	South	PATIALA	11KV	DS DIVN. RAIPURA	DS CITY S/D RAIPURA	D0165F04	DALNA	AMR	OK	31.03.2023	Category 1				774801	Not installed	11.140	NA	Director/D	
B.7692	South	PATIALA	11KV	DS DIVN. RAIPURA	DS CITY S/D RAIPURA	D0165F02	INDUSTRIAL 1	AMR	OK	31.03.2023	Category 1				5437509	Not installed				

S.No	Zone	Circle	Voltage Level (kVA)	Division (kVA)	Sub-Division (kVA)	Feeder ID	Feeder Name	Feeder Metering Status (Metered/unmetered/AMR/AMI)	Status of Meter (Functional/Non-Functional)	Metering Date (Date of last actual meter working/communication)	Feeder Type (Agr/Industrial/Mixed)	Status of Communication			Period from 01.04.2021 to 31.03.2022				Sales	Remarks (Source of data)
												% data received through automatically if feeder AMR/AMI	Number of hours when meter was unable to communicate in overall	Total Number of hours in the period	Meter S.No	CT/PT ratio	Import (kWh)	Export (kWh)		
B.7730	South	PATIALA	11KV	DS DIVN. RAIPURA	DS S/D SARAI BANJARA	D164FL02	CHANDUMAIRA	AMR	OK	31.03.2023	AP 3Phase 3Wire				12479387	Not installed	2,225	NA	Director/D	
B.7731	South	PATIALA	11KV	DS DIVN. RAIPURA	DS S/D SARAI BANJARA	D164FL11	JPPALHERI	AMR	OK	31.03.2023	AP 3Phase 3Wire				12479391	Not installed	2,372	NA	Director/D	
B.7732	South	PATIALA	11KV	DS DIVN. RAIPURA	DS S/D SARAI BANJARA	D164FL08	SALEMUR	AMR	OK	31.03.2023	AP 3Phase 3Wire				9140578	Not installed	2,529	NA	Director/D	
B.7733	South	PATIALA	11KV	DS DIVN. RAIPURA	DS S/D SARAI BANJARA	D164F09	ujain	AMR	OK	31.03.2023	AP 3Phase 3Wire				12479693	Not installed	2,614	NA	Director/D	
B.7734	South	PATIALA	11KV	DS DIVN. RAIPURA	DS S/D SARAI BANJARA	D164FL04	POLA	AMR	OK	31.03.2023	AP 3Phase 3Wire				9140634	Not installed	2,981	NA	Director/D	
B.7735	South	PATIALA	11KV	DS DIVN. RAIPURA	DS S/D SARAI BANJARA	D164FL18	DALLOMAJRA	AMR	OK	31.03.2023	AP 3Phase 3Wire				12479494	Not installed	3,084	NA	Director/D	
B.7736	South	PATIALA	11KV	DS DIVN. RAIPURA	DS S/D SARAI BANJARA	D164FL19	ups-3	AMR	OK	31.03.2023	Category 5-UPS				4802	Not installed	5,497	NA	Director/D	
B.7737	South	PATIALA	11KV	DS DIVN. RAIPURA	DS S/D SARAI BANJARA	D164FL07	UPS 1	AMR	OK	31.03.2023	Category 5-UPS				5295601	Not installed	10,044	NA	Director/D	
B.7738	South	PATIALA	11KV	DS DIVN. RAIPURA	DS S/D SARAI BANJARA	D164FL10	UPS 2	AMR	OK	31.03.2023	Category 5-UPS				9140632	Not installed	11,499	NA	Director/D	
B.7739	South	PATIALA	66KV	DS DIVN. RAIPURA	DS S/U S/D RAIPURA	D164FL19	M/S VVTHA INFRASTRUCTURE	Not available	OK	31.03.2023	Category 4				Not available	Not available	1,095	NA	Director/D	
B.7740	South	PATIALA	66KV	DS DIVN. RAIPURA	DS S/U S/D RAIPURA	D164FL05	ABC	Not available	OK	31.03.2023	Category 5				Not available	Not available	7,296	NA	Director/D	
B.7741	South	PATIALA	66KV	DS DIVN. RAIPURA	DS S/U S/D RAIPURA	D164FL06	ASIANFINE CEMENT	Not available	OK	31.03.2023	Category 4				Not available	Not available	13,898	NA	Director/D	
B.7742	South	PATIALA	66KV	DS DIVN. RAIPURA	DS S/U S/D RAIPURA	D164FL14	Vardhman	AMR	OK	31.03.2023	Category 4				Not available	Not available	42,660	NA	Director/D	
B.7743	South	PATIALA	11KV	DS DIVN. RAIPURA	DS S/U S/D RAIPURA	D164FL22	STATION T/F 66 KV NAUSHEHRA	AMR	OK	31.03.2023	Category 4				10040798	Not installed	0,027	NA	Director/D	
B.7744	South	PATIALA	11KV	DS DIVN. RAIPURA	DS S/U S/D RAIPURA	D164FL09	Bhumnaga	NON AMR	OK	31.03.2023	AP 3Phase 3Wire				9140652	Not installed	2,474	NA	Director/D	
B.7745	South	PATIALA	11KV	DS DIVN. RAIPURA	DS S/U S/D RAIPURA	D164FL13	GHAGGAR SARAIN	AMR	OK	31.03.2023	AP 3Phase 3Wire				11116941	Not installed	2,875	NA	Director/D	
B.7746	South	PATIALA	11KV	DS DIVN. RAIPURA	DS S/U S/D RAIPURA	D164FL06	nshera	AMR	OK	31.03.2023	AP 3Phase 3Wire				2068608	Not installed	3,241	NA	Director/D	
B.7747	South	PATIALA	11KV	DS DIVN. RAIPURA	DS S/U S/D RAIPURA	D164FL08	Shambhu AP	AMR	OK	31.03.2023	AP 3Phase 3Wire				9140655	Not installed	4,392	NA	Director/D	
B.7748	South	PATIALA	11KV	DS DIVN. RAIPURA	DS S/U S/D RAIPURA	D164FL01	Industrial (N)	AMR	OK	31.03.2023	Category 1				2066449	Not installed	10,435	NA	Director/D	
B.7749	South	PATIALA	11KV	DS DIVN. RAIPURA	DS S/U S/D RAIPURA	D164FL10	PARIAP	AMR	OK	31.03.2023	Category 4				2067330	Not installed	12,566	NA	Director/D	
B.7750	South	PATIALA	11KV	DS DIVN. RAIPURA	DS S/U S/D RAIPURA	D164FL07	UPS 3-Wire Shambhu	AMR	OK	31.03.2023	Category 5-UPS				778153	Not installed	15,667	NA	Director/D	
B.7751	South	PATIALA	11KV	DS DIVN. RAIPURA	DS S/U S/D RAIPURA	D164FL22	STATION T/F 66 KV FOCAL POINT	AMR	OK	31.03.2023	Category 4				1618	400-200/5-5	0,031	NA	Director/D	
B.7752	South	PATIALA	11KV	DS DIVN. RAIPURA	DS S/U S/D RAIPURA	D164FL07	katia	AMR	OK	31.03.2023	Category 4				2066815	Not installed	0,704	NA	Director/D	
B.7753	South	PATIALA	11KV	DS DIVN. RAIPURA	DS S/U S/D RAIPURA	D164FL15	CHAMARA	AMR	OK	31.03.2023	AP 3Phase 3Wire				33500	400-200/5-5	1,398	NA	Director/D	
B.7754	South	PATIALA	11KV	DS DIVN. RAIPURA	DS S/U S/D RAIPURA	D164FL10	GAJJIKHERA	AMR	OK	31.03.2023	AP 3Phase 3Wire				579625	Not installed	2,163	NA	Director/D	
B.7755	South	PATIALA	11KV	DS DIVN. RAIPURA	DS S/U S/D RAIPURA	D164FL08	Paton	AMR	OK	31.03.2023	AP 3Phase 3Wire				9140597	Not installed	2,406	NA	Director/D	
B.7756	South	PATIALA	11KV	DS DIVN. RAIPURA	DS S/U S/D RAIPURA	D164FL16	DABALI	AMR	OK	31.03.2023	AP 3Phase 3Wire				579624	Not installed	2,684	NA	Director/D	
B.7757	South	PATIALA	11KV	DS DIVN. RAIPURA	DS S/U S/D RAIPURA	D164FL09	Madampur	AMR	OK	31.03.2023	AP 3Phase 3Wire				9140596	Not installed	3,082	NA	Director/D	
B.7758	South	PATIALA	11KV	DS DIVN. RAIPURA	DS S/U S/D RAIPURA	D164FL11	NALAA	AMR	OK	31.03.2023	AP 3Phase 3Wire				9140598	Not installed	3,399	NA	Director/D	
B.7759	South	PATIALA	11KV	DS DIVN. RAIPURA	DS S/U S/D RAIPURA	D164FL14	SUNDER NAGAR RAIPURA	AMR	OK	31.03.2023	Category 1				30263	400-200/5-5	5,693	NA	Director/D	
B.7760	South	PATIALA	11KV	DS DIVN. RAIPURA	DS S/U S/D RAIPURA	D164FL20	Jps Ambala Road	AMR	OK	31.03.2023	Category 5-UPS				2066743	400-200/5-5	7,762	NA	Director/D	
B.7761	South	PATIALA	11KV	DS DIVN. RAIPURA	DS S/U S/D RAIPURA	D164FL17	BABA DEEP SINGH	AMR	OK	31.03.2023	Category 1				9140651	400-200/5-5	8,418	NA	Director/D	
B.7762	South	PATIALA	11KV	DS DIVN. RAIPURA	DS S/U S/D RAIPURA	D164FL21	FOCALPOINT CAT-2	AMR	OK	31.03.2023	Category 2				3394	400-200/5-5	8,465	NA	Director/D	
B.7763	South	PATIALA	11KV	DS DIVN. RAIPURA	DS S/U S/D RAIPURA	D164FL12	UPS RAIPURA	AMR	OK	31.03.2023	Category 5-UPS				12093422	400-200/5-5	9,174	NA	Director/D	
B.7764	South	PATIALA	11KV	DS DIVN. RAIPURA	DS S/U S/D RAIPURA	D164FL02	Industrial No.1 (FP)	AMR	OK	31.03.2023	Category 2				579629	Not installed	9,742	NA	Director/D	
B.7765	South	PATIALA	11KV	DS DIVN. RAIPURA	DS S/U S/D RAIPURA	D164FL18	Bharat colony	AMR	OK	31.03.2023	Category 1				579626	Not installed	9,999	NA	Director/D	
B.7766	South	PATIALA	11KV	DS DIVN. RAIPURA	DS S/U S/D RAIPURA	D164FL04	Sri J.P.	AMR	OK	31.03.2023	Category 5-UPS				579628	Not installed	10,966	NA	Director/D	
B.7767	South	PATIALA	11KV	DS DIVN. RAIPURA	DS S/U S/D RAIPURA	D164FL03	jalapur	AMR	OK	31.03.2023	Category 1				34509	Not installed	11,854	NA	Director/D	
B.7768	South	PATIALA	11KV	DS DIVN. RAIPURA	DS S/U S/D RAIPURA	D164FL01	stephen chemical	AMR	OK	31.03.2023	Category 4				579631	Not installed	12,966	NA	Director/D	
B.7769	South	PATIALA	11KV	DS DIVN. RAIPURA	DS S/U S/D RAIPURA	D164FL13	INDUSTRIAL NO 2 (FP)	AMR	OK	31.03.2023	Category 2				1630	Not installed	16,221	NA	Director/D	
B.7770	South	PATIALA	11KV	DS DIVN. RAIPURA	DS S/U S/D RAIPURA	FL190166	sood packers	AMR	OK	31.03.2023	Category 4				23410	400-200/5-5	18,248	NA	Director/D	
B.7771	South	PATIALA	11KV	DS DIVN. SAMANA	DS CTY S/D SAMANA	D155FL16	Sudhividyay	AMR	OK	31.03.2023	Category 2				2068153	Not installed	4,177	NA	Director/D	
B.7772	South	PATIALA	11KV	DS DIVN. SAMANA	DS CTY S/D SAMANA	D155FL04	PATIALA ROAD	AMR	OK	31.03.2023	Category 2				7039552	Not installed	5,510	NA	Director/D	
B.7773	South	PATIALA	11KV	DS DIVN. SAMANA	DS CTY S/D SAMANA	D155FL02	RAJA ROAD	AMR	OK	31.03.2023	Category 2				2067219	Not installed	9,162	NA	Director/D	
B.7774	South	PATIALA	11KV	DS DIVN. SAMANA	DS CTY S/D SAMANA	D155FL11	Premier Cotspin	AMR	OK	31.03.2023	Category 2				95801-20000	Not installed	14,250	NA	Director/D	
B.7775	South	PATIALA	11KV	DS DIVN. SAMANA	DS CTY S/D SAMANA	D176FL02	GAWEAS1 (F.P)	AMR	OK	31.03.2023	Category 2				2068208	Not installed	1,331	NA	Director/D	
B.7776	South	PATIALA	11KV	DS DIVN. SAMANA	DS CTY S/D SAMANA	D176FL06	KADRABD	AMR	OK	31.03.2023	AP 3Phase 3Wire				9140779	Not installed	2,233	NA	Director/D	
B.7777	South	PATIALA	11KV	DS DIVN. SAMANA	DS CTY S/D SAMANA	D176FL15	CHAWLA NEW	AMR	OK	31.03.2023	AP 3Phase 3Wire				2068208	Not installed	2,406	NA	Director/D	
B.7778	South	PATIALA	11KV	DS DIVN. SAMANA	DS CTY S/D SAMANA	D176FL14	TALWANDI NEW	AMR	OK	31.03.2023	AP 3Phase 3Wire				34175	Not installed	2,565	NA	Director/D	
B.7779	South	PATIALA	11KV	DS DIVN. SAMANA	DS CTY S/D SAMANA	D176FL04	CHNNA	AMR	OK	31.03.2023	AP 3Phase 3Wire				9140778	Not installed	2,578	NA	Director/D	
B.7780	South	PATIALA	11KV	DS DIVN. SAMANA	DS CTY S/D SAMANA	D176FL17	Bhore wala	AMR	OK	31.03.2023	AP 3Phase 3Wire				4412	Not installed	2,677	NA	Director/D	
B.7781	South	PATIALA	11KV	DS DIVN. SAMANA	DS CTY S/D SAMANA	D176FL01	KULARAN	AMR	OK	31.03.2023	AP 3Phase 3Wire				2068144	Not installed	2,731	NA	Director/D	
B.7782	South	PATIALA	11KV	DS DIVN. SAMANA	DS CTY S/D SAMANA	D176FL08	ALAMPUR	AMR	OK	31.03.2023	AP 3Phase 3Wire				8221387	Not installed	2,826	NA	Director/D	
B.7783	South	PATIALA	11KV	DS DIVN. SAMANA	DS CTY S/D SAMANA	D176FL13	Kothariwala	AMR	OK	31.03.2023	AP 3Phase 3Wire				9140780	Not installed	3,594	NA	Director/D	
B.7784	South	PATIALA	11KV	DS DIVN. SAMANA	DS CTY S/D SAMANA	D176FL11	GAUPIR	AMR	OK	31.03.2023	AP 3Phase 3Wire				4581	Not installed	3,878	NA	Director/D	
B.7785	South	PATIALA	11KV	DS DIVN. SAMANA	DS CTY S/D SAMANA	D176FL10	NAMAAND	AMR	OK	31.03.2023	AP 3Phase 3Wire				8223376	Not installed	4,290	NA	Director/D	
B.7786	South	PATIALA	11KV	DS DIVN. SAMANA	DS CTY S/D SAMANA	D176FL03	TALWANDI	AMR	OK	31.03.2023	AP 3Phase 3Wire				9140776	Not installed	4,444	NA	Director/D	
B.7787	South	PATIALA	11KV	DS DIVN. SAMANA	DS CTY S/D SAMANA	D176FL07	GAWEAS2(UPS)	AMR	OK	31.03.2023	Category 5-UPS				23654	Not installed	13,888	NA	Director/D	
B.7788	South	PATIALA	11KV	DS DIVN. SAMANA	DS CTY S/D SAMANA	D199FL11	BHAWANA NEW	AMR	OK	31.03.2023	AP 3Phase 3Wire				9140781	900-450/577/1-1-1	1,046	NA	Director/D	
B.7789	South	PATIALA	11KV	DS DIVN. SAMANA	DS CTY S/D SAMANA	D199FL15	New Gajra-2	NON AMR	OK	31.03.2023	Category 2				6045	900-450/577/1-1-1	1,707	NA	Director/D	
B.7790	South	PATIALA	11KV	DS DIVN. SAMANA	DS CTY S/D SAMANA	D19905	kahangah 2	AMR	OK	31.03.2023	AP 3Phase 3Wire				23220	Not installed	1,864	NA	Director/D	
B.7791	South	PATIALA	11KV	DS DIVN. SAMANA	DS CTY S/D SAMANA	D199FT02	BANNA RURAL	NON AMR	OK	31.03.2023	AP 3Phase 3Wire				12479784	Not installed	2,402	NA	Director/D	
B.7792	South	PATIALA	11KV	DS DIVN. SAMANA	DS CTY S/D SAMANA	D199FL08	G. T B	AMR	OK	31.03.2023	Category 2				13190489	Not installed	4,540	NA	Director/D	
B.7793	South	PATIALA	11KV	DS DIVN. SAMANA	DS CTY S/D SAMANA	H144199	white gold	NON AMR	OK	31.03.2023	Category 2				2732	Not installed	4,670	NA	Director/D	
B.7794	South	PATIALA	11KV	DS DIVN. SAMANA	DS CTY S/D SAMANA	D199FT06	BHAWANA 2	NON AMR	OK	31.03.2023	Category 2				12003469	Not installed	6,491	NA	Director/D	
B.7795	South	PATIALA	11KV	DS DIVN. SAMANA	DS CTY S/D SAMANA	D199FT03	CITY BANNA	AMR	OK	31.03.2023	Category 1				11052058	Not installed	6,519	NA	Director/D	
B.7796	South	PATIALA	11KV	DS DIVN. SAMANA	DS CTY S/D SAMANA	D199FL13	G. C industry	AMR	OK	31.03.2023	Category 2				5742	Not installed	9,066	NA	Director/D	
B.7797	South	PATIALA	11KV	DS DIVN. SAMANA	DS CTY S/D SAMANA	D199FL12	Gajra	NON AMR	OK	31.03.2023	Category 2				43170	900-450/577/1-1-1	17,252	NA	Director/D	
B.7798	South	PATIALA	11KV	DS DIVN. SAMANA	DS CTY S/D SAMANA	D199FT05	Gupta thread	NON AMR	OK	31.03.2023	Category 4									

S.No	Zone	Circle	Voltage Level (kVA)	Division (kVA)	Sub-Division (kVA)	Feeder ID	Feeder Name	Feeder Metering Status (Metered/unmetered/AMR/AMI)	Status of Meter (Functional/Non-Functional)	Metering Date (Date of last actual meter reading/communication)	Feeder Type (Agr/Industrial/Mixed)	Status of Communication			Period from 01.04.2021 to 31.03.2022				Sales	Remarks (Source of data)
												% data received through automatically if feeder AMR/AMI	Number of hours when meter was unable to communicate in week	Total Number of hours in the period	Meter S.No	CT/PT ratio	Import (kU)	Export (kU)		
B.7827	South	PATIALA	11KV	DS DIVN. SAMANA	DS S/D BADSHAHPUR	0175F07	ARNETU	AMR	OK	31.03.2023	AP 3Phase 3Wire				9140594	Not installed	3.051	NA	Director/D	
B.7828	South	PATIALA	11KV	DS DIVN. SAMANA	DS S/D BADSHAHPUR	0175F11	Partha	AMR	OK	31.03.2023	AP 3Phase 3Wire				7035640	900-450/577/1-1-1	3.550	NA	Director/D	
B.7829	South	PATIALA	11KV	DS DIVN. SAMANA	DS S/D BADSHAHPUR	0175F04	HARCHANDPURA	NON AMR	OK	31.03.2023	AP 3Phase 3Wire				6740688	Not installed	3.817	NA	Director/D	
B.7830	South	PATIALA	11KV	DS DIVN. SAMANA	DS S/D BADSHAHPUR	0175F09	Buaj Singhwala	AMR	OK	31.03.2023	AP 3Phase 3Wire				1027178	900-450/577/1-1-1	3.982	NA	Director/D	
B.7831	South	PATIALA	11KV	DS DIVN. SAMANA	DS S/D BADSHAHPUR	0175F15	Gurdial Pure	AMR	OK	31.03.2023	AP 3Phase 3Wire				2068187	Not installed	4.235	NA	Director/D	
B.7832	South	PATIALA	11KV	DS DIVN. SAMANA	DS S/D BADSHAHPUR	0175F05	UPS BADSHAHPUR	AMR	OK	31.03.2023	Category 5-UPS				10273801	900-450/577/1-1-1	11.343	NA	Director/D	
B.7833	South	PATIALA	11KV	DS DIVN. SAMANA	DS S/D BADSHAHPUR	0175F10	City Badshahpur	AMR	OK	31.03.2023	Category 1				4221016	Not installed	11.909	NA	Director/D	
B.7834	South	PATIALA	11KV	DS DIVN. SAMANA	DS S/D BADSHAHPUR	0198F10	substation jora majra	NON AMR	OK	31.03.2023	Category 1				9094118	1200/577/1-1-1	0.027	NA	Director/D	
B.7835	South	PATIALA	11KV	DS DIVN. SAMANA	DS S/D BADSHAHPUR	0198F05	CTY JORAMAIRA	NON AMR	OK	31.03.2023	Category 1				11060897	1200/577/1-1-1	1.060	NA	Director/D	
B.7836	South	PATIALA	11KV	DS DIVN. SAMANA	DS S/D BADSHAHPUR	0198F13	Mardheri	NON AMR	OK	31.03.2023	AP 3Phase 3Wire				197927	900-450/577/1-1-1	1.662	NA	Director/D	
B.7837	South	PATIALA	11KV	DS DIVN. SAMANA	DS S/D BADSHAHPUR	0198F20	11 KV NANHERA	NON AMR	OK	31.03.2023	AP 3Phase 3Wire				11060897	1200/577/1-1-1	1.783	NA	Director/D	
B.7838	South	PATIALA	11KV	DS DIVN. SAMANA	DS S/D BADSHAHPUR	0198F06	Marori Jauramajra	NON AMR	OK	31.03.2023	AP 3Phase 3Wire				11060911	1200/577/1-1-1	2.099	NA	Director/D	
B.7839	South	PATIALA	11KV	DS DIVN. SAMANA	DS S/D BADSHAHPUR	0198F14	Aral majra	NON AMR	OK	31.03.2023	AP 3Phase 3Wire				198025	900-450/577/1-1-1	2.388	NA	Director/D	
B.7840	South	PATIALA	11KV	DS DIVN. SAMANA	DS S/D BADSHAHPUR	0198F01	Lukri Majra	NON AMR	OK	31.03.2023	AP 3Phase 3Wire				11060892	1200/577/1-1-1	2.896	NA	Director/D	
B.7841	South	PATIALA	11KV	DS DIVN. SAMANA	DS S/D BADSHAHPUR	0198F12	UPS marori	AMR	OK	31.03.2023	Category 5-UPS				900-450/577/1-1-1	8.305	NA	Director/D		
B.7842	South	PATIALA	11KV	DS DIVN. SAMANA	DS S/D BADSHAHPUR	0173F10	Marori Kakrala	AMR	OK	31.03.2023	AP 3Phase 3Wire				8223059	Not installed	1.558	NA	Director/D	
B.7843	South	PATIALA	11KV	DS DIVN. SAMANA	DS S/D BADSHAHPUR	0173F06	BELU MAIRA	AMR	OK	31.03.2023	AP 3Phase 3Wire				9140661	Not installed	1.597	NA	Director/D	
B.7844	South	PATIALA	11KV	DS DIVN. SAMANA	DS S/D BADSHAHPUR	0173F07	JORA MAIRA	AMR	OK	31.03.2023	AP 3Phase 3Wire				9140669	Not installed	1.633	NA	Director/D	
B.7845	South	PATIALA	11KV	DS DIVN. SAMANA	DS S/D BADSHAHPUR	0173F16	Ap Nagar 2	AMR	OK	31.03.2023	AP 3Phase 3Wire				8222504	Not installed	2.168	NA	Director/D	
B.7846	South	PATIALA	11KV	DS DIVN. SAMANA	DS S/D BADSHAHPUR	0173F17	UPS Chukri	AMR	OK	31.03.2023	Category 5-UPS				11145599	Not installed	3.023	NA	Director/D	
B.7847	South	PATIALA	11KV	DS DIVN. SAMANA	DS S/D GAJUMAJRA	0177F18	11 KV Substation Gajumajra	AMR	OK	31.03.2023	Substation Transformer				2067652	Not installed	0.004	NA	Director/D	
B.7848	South	PATIALA	11KV	DS DIVN. SAMANA	DS S/D GAJUMAJRA	0177F23	BARSA 2	AMR	OK	31.03.2023	AP 3Phase 3Wire				5700	Not installed	1.945	NA	Director/D	
B.7849	South	PATIALA	11KV	DS DIVN. SAMANA	DS S/D GAJUMAJRA	0177F04	Bhems Kheri	AMR	OK	31.03.2023	AP 3Phase 3Wire				12479374	Not installed	2.035	NA	Director/D	
B.7850	South	PATIALA	11KV	DS DIVN. SAMANA	DS S/D GAJUMAJRA	0177F20	KOKKA NEW	AMR	OK	31.03.2023	AP 3Phase 3Wire				5407	Not installed	2.082	NA	Director/D	
B.7851	South	PATIALA	11KV	DS DIVN. SAMANA	DS S/D GAJUMAJRA	0177F16	MAURI	AMR	OK	31.03.2023	AP 3Phase 3Wire				8223864	Not installed	2.083	NA	Director/D	
B.7852	South	PATIALA	11KV	DS DIVN. SAMANA	DS S/D GAJUMAJRA	0177F12	BAOSHAPUR	AMR	OK	31.03.2023	AP 3Phase 3Wire				5231	Not installed	2.163	NA	Director/D	
B.7853	South	PATIALA	11KV	DS DIVN. SAMANA	DS S/D GAJUMAJRA	0177F21	SENSEWAL	AMR	OK	31.03.2023	AP 3Phase 3Wire				5307	Not installed	2.187	NA	Director/D	
B.7854	South	PATIALA	11KV	DS DIVN. SAMANA	DS S/D GAJUMAJRA	0177F03	MALLAN	AMR	OK	31.03.2023	AP 3Phase 3Wire				8222810	Not installed	2.286	NA	Director/D	
B.7855	South	PATIALA	11KV	DS DIVN. SAMANA	DS S/D GAJUMAJRA	0177F14	BHEDPURA	AMR	OK	31.03.2023	AP 3Phase 3Wire				8222808	Not installed	2.303	NA	Director/D	
B.7856	South	PATIALA	11KV	DS DIVN. SAMANA	DS S/D GAJUMAJRA	0177F17	Tiora	AMR	OK	31.03.2023	AP 3Phase 3Wire				8223863	Not installed	2.934	NA	Director/D	
B.7857	South	PATIALA	11KV	DS DIVN. SAMANA	DS S/D GAJUMAJRA	0177F24	ACHRAL	AMR	OK	31.03.2023	AP 3Phase 3Wire				5748	Not installed	2.996	NA	Director/D	
B.7858	South	PATIALA	11KV	DS DIVN. SAMANA	DS S/D GAJUMAJRA	0177F12	SABARPUR FEEDER	AMR	OK	31.03.2023	AP 3Phase 3Wire				8223807	Not installed	2.598	NA	Director/D	
B.7859	South	PATIALA	11KV	DS DIVN. SAMANA	DS S/D GAJUMAJRA	0177F15	KOKKA OLD	AMR	OK	31.03.2023	AP 3Phase 3Wire				12479799	Not installed	2.745	NA	Director/D	
B.7860	South	PATIALA	11KV	DS DIVN. SAMANA	DS S/D GAJUMAJRA	0177F19	UPS Torra	AMR	OK	31.03.2023	Category 5-UPS				4104	Not installed	4.894	NA	Director/D	
B.7861	South	PATIALA	11KV	DS DIVN. SAMANA	DS S/D GAJUMAJRA	0177F07	UPS GAJU MAIRA	AMR	OK	31.03.2023	Category 5-UPS				2066879	Not installed	6.527	NA	Director/D	
B.7862	South	PATIALA	11KV	DS DIVN. SAMANA	DS S/D GAJUMAJRA	K155F06	TIORA KALAN	AMR	OK	31.03.2023	AP 3Phase 3Wire				571626	Not installed	1.211	NA	Director/D	
B.7863	South	PATIALA	11KV	DS DIVN. SAMANA	DS S/D GAJUMAJRA	K155F07	SUL TANPUR	AMR	OK	31.03.2023	AP 3Phase 3Wire				15143796	Not installed	2.295	NA	Director/D	
B.7864	South	PATIALA	11KV	DS DIVN. SAMANA	DS S/D GAJUMAJRA	K156F17	Substation Fatehmajri	NON AMR	OK	31.03.2023	Substation Transformer				1631	900-450/577/1-1-1	0.027	NA	Director/D	
B.7865	South	PATIALA	11KV	DS DIVN. SAMANA	DS S/D GAJUMAJRA	K15603	Achral Kalan	NON AMR	OK	31.03.2023	AP 3Phase 3Wire				12093601	900-450/577/1-1-1	1.190	NA	Director/D	
B.7866	South	PATIALA	11KV	DS DIVN. SAMANA	DS S/D GAJUMAJRA	K15604	Fatehmajri	AMR	OK	31.03.2023	Category 1				12093499	900-450/577/1-1-1	1.532	NA	Director/D	
B.7867	South	PATIALA	11KV	DS DIVN. SAMANA	DS S/D GAJUMAJRA	K156F15	BHEEMA KHERI 2	AMR	OK	31.03.2023	AP 3Phase 3Wire				16198463	900-450/577/1-1-1	1.614	NA	Director/D	
B.7868	South	PATIALA	11KV	DS DIVN. SAMANA	DS S/D GAJUMAJRA	K156F06	LALCOHH	AMR	OK	31.03.2023	AP 3Phase 3Wire				36896	900-450/577/1-1-1	2.188	NA	Director/D	
B.7869	South	PATIALA	11KV	DS DIVN. SAMANA	DS S/D GAJUMAJRA	0195F17	Birha Sahib	AMR	OK	31.03.2023	AP 3Phase 3Wire				40979	1200/577/1-1-1	1.685	NA	Director/D	
B.7870	South	PATIALA	11KV	DS DIVN. SAMANA	DS S/D GAJUMAJRA	0195F03	Barsat	AMR	OK	31.03.2023	AP 3Phase 3Wire				3327	1200/577/1-1-1	1.975	NA	Director/D	
B.7871	South	PATIALA	11KV	DS DIVN. SAMANA	DS S/D GAJUMAJRA	0195F16	UPS Shekhpur	AMR	OK	31.03.2023	Category 5-UPS				4973	1200/577/1-1-1	5.805	NA	Director/D	
B.7872	South	PATIALA	11KV	DS DIVN. SAMANA	DS S/U S/D SAMANA	B155F05	KAMASPUR	AMR	OK	31.03.2023	AP 3Phase 3Wire				9140742	Not installed	1.058	NA	Director/D	
B.7873	South	PATIALA	11KV	DS DIVN. SAMANA	DS S/U S/D SAMANA	B155F09	DANIPUR	AMR	OK	31.03.2023	AP 3Phase 3Wire				2067623	Not installed	1.779	NA	Director/D	
B.7874	South	PATIALA	11KV	DS DIVN. SAMANA	DS S/U S/D SAMANA	B155F01	KOTI JORAN	AMR	OK	31.03.2023	AP 3Phase 3Wire				169298	Not installed	1.492	NA	Director/D	
B.7875	South	PATIALA	11KV	DS DIVN. SAMANA	DS S/U S/D SAMANA	B155F18	Fatehur	NON AMR	OK	31.03.2023	AP 3Phase 3Wire				8223745	Not installed	1.856	NA	Director/D	
B.7876	South	PATIALA	11KV	DS DIVN. SAMANA	DS S/U S/D SAMANA	B155F03	DULLAR	AMR	OK	31.03.2023	AP 3Phase 3Wire				12093424	Not installed	1.938	NA	Director/D	
B.7877	South	PATIALA	11KV	DS DIVN. SAMANA	DS S/U S/D SAMANA	B155F19	Fatehpur	AMR	OK	31.03.2023	AP 3Phase 3Wire				7039552	Not installed	2.485	NA	Director/D	
B.7878	South	PATIALA	11KV	DS DIVN. SAMANA	DS S/U S/D SAMANA	B155F20	11 kv BLUE ROSE	AMR	OK	31.03.2023	Category 2				9140742	Not installed	2.716	NA	Director/D	
B.7879	South	PATIALA	11KV	DS DIVN. SAMANA	DS S/U S/D SAMANA	B155F06	UPS (TODARPUR)	NON AMR	OK	31.03.2023	Category 5-UPS				2068332	Not installed	3.401	NA	Director/D	
B.7880	South	PATIALA	11KV	DS DIVN. SAMANA	DS S/U S/D SAMANA	B155F15	Substation	AMR	OK	31.03.2023	Category 1				2067623	Not installed	1.885	NA	Director/D	
B.7881	South	PATIALA	11KV	DS DIVN. SAMANA	DS S/U S/D SAMANA	B155F17	Paras cottspin	NON AMR	OK	31.03.2023	Category 2				16992927	Not installed	9.609	NA	Director/D	
B.7882	South	PATIALA	11KV	DS DIVN. SAMANA	DS S/U S/D SAMANA	L104B155	URBAN RAJLA	NON AMR	OK	31.03.2023	Category 1				11116823	Not installed	10.222	NA	Director/D	
B.7883	South	PATIALA	11KV	DS DIVN. SAMANA	DS S/U S/D SAMANA	B155F13	City S/D JS fabric	NON AMR	OK	31.03.2023	Category 1				24388	Not installed	11.423	NA	Director/D	
B.7884	South	PATIALA	11KV	DS DIVN. SAMANA	DS S/U S/D SAMANA	0155F12	GM SPIN FAB	AMR	OK	31.03.2023	Category 4				12093424	Not installed	16.839	NA	Director/D	
B.7885	South	PATIALA	11KV	DS DIVN. SAMANA	DS S/U S/D SAMANA	B155F05	KOTI JORAN	AMR	OK	31.03.2023	AP 3Phase 3Wire				3063176	900-450/577/1-1-1	2.166	NA	Director/D	
B.7886	South	PATIALA	11KV	DS DIVN. SAMANA	DS S/U S/D SAMANA	0176F13	City S/D namandan	AMR	OK	31.03.2023	Category 5-UPS				1584	Not installed	10.027	NA	Director/D	
B.7887	South	PATIALA	11KV	DS DIVN. SAMANA	DS S/U S/D SAMANA	0199F09	SEHAIPURA bhamaana	AMR	OK	31.03.2023	AP 3Phase 3Wire				43145	900-450/577/1-1-1	1.573	NA	Director/D	
B.7888	South	PATIALA	11KV	DS DIVN. SAMANA	DS S/U S/D SAMANA	TP1F108	DHAINITAL	AMR	OK	31.03.2023	Category 5-UPS				16199368	Not installed	5.385	NA	Director/D	
B.7889	South	PATIALA	11KV	DS DIVN. SAMANA	DS S/U S/D SAMANA	TP01F08	KHANPUR	AMR	OK	31.03.2023	AP 3Phase 3Wire				44924	900-450/577/1-1-1	1.941	NA	Director/D	
B.7890	South	PATIALA	11KV	DS DIVN. SAMANA	DS S/U S/D SAMANA	L111001	Morli farm	AMR	OK	31.03.2023	AP 3Phase 3Wire				44918	900-450/577/1-1-1	2.136	NA	Director/D	
B.7891	South	PATIALA	11KV	DS DIVN. SAMANA	DS S/U S/D SAMANA	0198F07	Johnnawal	NON AMR	OK	31.03.2023	AP 3Phase 3Wire				5991	900-450/577/1-1-1	1.104	NA	Director/D	
B.7892	South	PATIALA	11KV	DS DIVN. SAMANA	DS S/U S/D SAMANA	0198F02	RAIGARH	AMR	OK	31.03.2023	AP 3Phase 3Wire				11060894	1200/577/1-1-1	1.863	NA	Director/D	
B.7893	South	PATIALA	11KV	DS DIVN. SAMANA	DS S/U S/D SAMANA	0198F18	11 KV SEHAIPURA	NON AMR	OK	31.03.2023	AP 3Phase 3Wire				4976	1200/577/1-1-1	2.069			

S.No	Zone	Circle	Voltage Level (kVA)	Division (kVA)	Sub-Division (kVA)	Feeder ID	Feeder Name	Feeder Metering Status (Metered/unmetered/AMR/AMI)	Status of Meter (Functional/Non-Functional)	Metering Date (Date of last actual meter reading/communication)	Feeder Type (Agr/Industrial/Mixed)	Status of Communication			Period from 01.04.2021 to 31.03.2022				Sales	Remarks (Source of data)
												% data received through automatically if feeder AMR/AMI	Number of hours when meter was unable to communicate in week	Total Number of hours in the period	Meter S.No	CT/PT ratio	Import (kU)	Export (kU)		
B.7924	South	PATIALA	11KV	DS DIVN. SAMANA	DS S/U S/D SAMANA	D174FL18	DROLI samana	AMR	OK	31.03.2023	AP 3Phase 3Wire	579620	1200/ 577/1-1-1	4.664		NA	Director/D			
B.7925	South	PATIALA	11KV	DS DIVN. SAMANA	DS S/U S/D SAMANA	D174FL05	REGHAR	AMR	OK	31.03.2023	AP 3Phase 3Wire	9140824	Not installed	5.206		NA	Director/D			
B.7926	South	PATIALA	11KV	DS DIVN. SAMANA	DS S/U S/D SAMANA	D178FL01	DHENTHAL	AMR	OK	31.03.2023	AP 3Phase 3Wire	9140851	Not installed	1.206		NA	Director/D			
B.7927	South	PATIALA	11KV	DS DIVN. SAMANA	DS S/U S/D SAMANA	D178FL15	URBAN CAT 1	AMR	OK	31.03.2023	AP 3Phase 3Wire	4417	Not installed	1.213		NA	Director/D			
B.7928	South	PATIALA	11KV	DS DIVN. SAMANA	DS S/U S/D SAMANA	D178FL19	Takshnamraja	AMR	OK	31.03.2023	AP 3Phase 3Wire	4405	Not installed	1.707		NA	Director/D			
B.7929	South	PATIALA	11KV	DS DIVN. SAMANA	DS S/U S/D SAMANA	D178FL04	TODARPUR	AMR	OK	31.03.2023	AP 3Phase 3Wire	9140852	Not installed	1.847		NA	Director/D			
B.7930	South	PATIALA	11KV	DS DIVN. SAMANA	DS S/U S/D SAMANA	D178FL17	Chupki	AMR	OK	31.03.2023	AP 3Phase 3Wire	4052	Not installed	1.909		NA	Director/D			
B.7931	South	PATIALA	11KV	DS DIVN. SAMANA	DS S/U S/D SAMANA	D178FL18	Nasapur	AMR	OK	31.03.2023	AP 3Phase 3Wire	4413	Not installed	1.925		NA	Director/D			
B.7932	South	PATIALA	11KV	DS DIVN. SAMANA	DS S/U S/D SAMANA	D178FL16	Mallin	AMR	OK	31.03.2023	AP 3Phase 3Wire	4414	Not installed	2.16		NA	Director/D			
B.7933	South	PATIALA	11KV	DS DIVN. SAMANA	DS S/U S/D SAMANA	D178FL05	FATTA KHRI	AMR	OK	31.03.2023	AP 3Phase 3Wire	9140629	Not installed	2.116		NA	Director/D			
B.7934	South	PATIALA	11KV	DS DIVN. SAMANA	DS S/U S/D SAMANA	D178FL10	DROLI (tulewal)	AMR	OK	31.03.2023	AP 3Phase 3Wire	1619434	Not installed	2.278		NA	Director/D			
B.7935	South	PATIALA	11KV	DS DIVN. SAMANA	DS S/U S/D SAMANA	D178FL06	UPS (TULEWAL)	AMR	OK	31.03.2023	Category 5-UPS	6669356	Not installed	6.004		NA	Director/D			
B.7936	South	PATIALA	11KV	DS EAST DIVN PATIALA	DS CANTT. S/D PATIALA	X155FL01	S/Sin Chauth	AMR	OK	31.03.2023	Substation Transformer	23415	Not installed	0.054		NA	Director/D			
B.7937	South	PATIALA	11KV	DS EAST DIVN PATIALA	DS CANTT. S/D PATIALA	X155FL03	11 kv Bhakha	AMR	OK	31.03.2023	AP 3Phase 3Wire	23503	Not installed	1.153		NA	Director/D			
B.7938	South	PATIALA	11KV	DS EAST DIVN PATIALA	DS CANTT. S/D PATIALA	X155FL02	BHANRA AP	AMR	OK	31.03.2023	AP 3Phase 3Wire	2657	Not installed	1.926		NA	Director/D			
B.7939	South	PATIALA	11KV	DS EAST DIVN PATIALA	DS CANTT. S/D PATIALA	X155FL02	11 KV PAHARPUR	NON AMR	OK	31.03.2023	AP 3Phase 3Wire	23438	Not installed	2.235		NA	Director/D			
B.7940	South	PATIALA	11KV	DS EAST DIVN PATIALA	DS CANTT. S/D PATIALA	X155FL04	Chohal UPS	AMR	OK	31.03.2023	Category 5-UPS	23491	Not installed	5.204		NA	Director/D			
B.7941	South	PATIALA	11KV	DS EAST DIVN PATIALA	DS CANTT. S/D PATIALA	D189FL12	PALACE FEEDER	AMR	OK	31.03.2023	AP 3Phase 3Wire	1028282	Not installed	1.732		NA	Director/D			
B.7942	South	PATIALA	11KV	DS EAST DIVN PATIALA	DS CANTT. S/D PATIALA	D189FL13	DUDHAR	AMR	OK	31.03.2023	AP 3Phase 3Wire	1247938	Not installed	2.375		NA	Director/D			
B.7943	South	PATIALA	11KV	DS EAST DIVN PATIALA	DS CANTT. S/D PATIALA	D189FL02	Train	NON AMR	OK	31.03.2023	Category 4	8223881	Not installed	2.416		NA	Director/D			
B.7944	South	PATIALA	11KV	DS EAST DIVN PATIALA	DS CANTT. S/D PATIALA	D189FL17	11 kv dikala dehati	AMR	OK	31.03.2023	AP 3Phase 3Wire	2068145	Not installed	2.805		NA	Director/D			
B.7945	South	PATIALA	11KV	DS EAST DIVN PATIALA	DS CANTT. S/D PATIALA	D189FL18	11 KV SAFRA	AMR	OK	31.03.2023	AP 3Phase 3Wire	2066700	Not installed	3.145		NA	Director/D			
B.7946	South	PATIALA	11KV	DS EAST DIVN PATIALA	DS CANTT. S/D PATIALA	D189FL01	Jhandi	AMR	OK	31.03.2023	AP 3Phase 3Wire	8223882	Not installed	3.155		NA	Director/D			
B.7947	South	PATIALA	11KV	DS EAST DIVN PATIALA	DS CANTT. S/D PATIALA	D189FL08	JALAKHERA CAT-1	AMR	OK	31.03.2023	Category 5-UPS	4830	Not installed	3.444		NA	Director/D			
B.7948	South	PATIALA	11KV	DS EAST DIVN PATIALA	DS CANTT. S/D PATIALA	D189FL03	Dakala Urban	AMR	OK	31.03.2023	Category 1	2066672	Not installed	4.969		NA	Director/D			
B.7949	South	PATIALA	11KV	DS EAST DIVN PATIALA	DS CANTT. S/D PATIALA	D189FL05	Bahli Paper Mill	AMR	OK	31.03.2023	Category 4	2064389	Not installed	18.691		NA	Director/D			
B.7950	South	PATIALA	11KV	DS EAST DIVN PATIALA	DS CANTT. S/D PATIALA	D189FL07	D.S.G.	Not available	OK	31.03.2023	Category 4	2066843	Not installed	26.263		NA	Director/D			
B.7951	South	PATIALA	66KV	DS EAST DIVN PATIALA	DS CANTT. S/D PATIALA	D1780178	Radiant Textile Mill	AMR	OK	31.03.2023	Category 1	Not available	Not available	25.124		NA	Director/D			
B.7952	South	PATIALA	11KV	DS EAST DIVN PATIALA	DS CANTT. S/D PATIALA	D157FL31	station transformer nis grid	AMR	OK	31.03.2023	Substation Transformer	2066410	900-450/ 577/1-1-1	0.081		NA	Director/D			
B.7953	South	PATIALA	11KV	DS EAST DIVN PATIALA	DS CANTT. S/D PATIALA	D157FL03	Maen	AMR	OK	31.03.2023	AP 3Phase 3Wire	8222793	Not installed	2.073		NA	Director/D			
B.7954	South	PATIALA	11KV	DS EAST DIVN PATIALA	DS CANTT. S/D PATIALA	D157FL01	Khera jattan	AMR	OK	31.03.2023	AP 3Phase 3Wire	8222695	Not installed	2.962		NA	Director/D			
B.7955	South	PATIALA	11KV	DS EAST DIVN PATIALA	DS CANTT. S/D PATIALA	D157FL02	Kastarpura	AMR	OK	31.03.2023	Category 1	2065287	Not installed	5.243		NA	Director/D			
B.7956	South	PATIALA	11KV	DS EAST DIVN PATIALA	DS CANTT. S/D PATIALA	D157FL10	Dakala UPS	AMR	OK	31.03.2023	Category 4	3351	Not installed	8.321		NA	Director/D			
B.7957	South	PATIALA	11KV	DS EAST DIVN PATIALA	DS CANTT. S/D PATIALA	D159FL04	Patiala Distillery	AMR	OK	31.03.2023	Category 4	2066618	Not installed	0.617		NA	Director/D			
B.7958	South	PATIALA	11KV	DS EAST DIVN PATIALA	DS CANTT. S/D PATIALA	D159FL20	11 kv Mallomajara	AMR	OK	31.03.2023	AP 3Phase 3Wire	4862	Not installed	0.732		NA	Director/D			
B.7959	South	PATIALA	11KV	DS EAST DIVN PATIALA	DS CANTT. S/D PATIALA	D159FL16	Bhanri	AMR	OK	31.03.2023	AP 3Phase 3Wire	2066981	Not installed	1.553		NA	Director/D			
B.7960	South	PATIALA	11KV	DS EAST DIVN PATIALA	DS CANTT. S/D PATIALA	D159FL01	Sullia Bhanri	AMR	OK	31.03.2023	AP 3Phase 3Wire	23442	Not installed	2.064		NA	Director/D			
B.7961	South	PATIALA	11KV	DS EAST DIVN PATIALA	DS CANTT. S/D PATIALA	D159FL13	Draula	AMR	OK	31.03.2023	AP 3Phase 3Wire	9140664	Not installed	2.353		NA	Director/D			
B.7962	South	PATIALA	11KV	DS EAST DIVN PATIALA	DS CANTT. S/D PATIALA	D181E12	SUE WALA	AMR	OK	31.03.2023	AP 3Phase 3Wire	12479773	Not installed	2.783		NA	Director/D			
B.7963	South	PATIALA	11KV	DS EAST DIVN PATIALA	DS CANTT. S/D PATIALA	D159FL17	11 kv Drain	AMR	OK	31.03.2023	Category 4	8223727	Not installed	2.787		NA	Director/D			
B.7964	South	PATIALA	11KV	DS EAST DIVN PATIALA	DS CANTT. S/D PATIALA	D159FL06	langroi	AMR	OK	31.03.2023	AP 3Phase 3Wire	9140747	Not installed	2.918		NA	Director/D			
B.7965	South	PATIALA	11KV	DS EAST DIVN PATIALA	DS CANTT. S/D PATIALA	D159FL15	Dhakraba	AMR	OK	31.03.2023	AP 3Phase 3Wire	2067442	Not installed	3.203		NA	Director/D			
B.7966	South	PATIALA	11KV	DS EAST DIVN PATIALA	DS CANTT. S/D PATIALA	D159FL05	Makhi	AMR	OK	31.03.2023	Category 1	2067661	Not installed	6.739		NA	Director/D			
B.7967	South	PATIALA	11KV	DS EAST DIVN PATIALA	DS CANTT. S/D PATIALA	D159FL19	SSG PAPER MILL	AMR	OK	31.03.2023	Category 4	4862	Not installed	6.781		NA	Director/D			
B.7968	South	PATIALA	11KV	DS EAST DIVN PATIALA	DS CANTT. S/D PATIALA	D159FL12	Sher Majra	AMR	OK	31.03.2023	Category 1	9140748	Not installed	8.527		NA	Director/D			
B.7969	South	PATIALA	11KV	DS EAST DIVN PATIALA	DS CANTT. S/D PATIALA	D178FL105	Paharpur	AMR	OK	31.03.2023	AP 3Phase 3Wire	34128	Not installed	1.566		NA	Director/D			
B.7970	South	PATIALA	11KV	DS EAST DIVN PATIALA	DS CANTT. S/D PATIALA	D178FL14	thounth AP	AMR	OK	31.03.2023	AP 3Phase 3Wire	49736	Not installed	2.484		NA	Director/D			
B.7971	South	PATIALA	11KV	DS EAST DIVN PATIALA	DS S/D DEVIAGARH	X157FL06	AMR	OK	31.03.2023	Category 4	98	900-450/ 577/1-1-1	1.616		NA	Director/D				
B.7972	South	PATIALA	11KV	DS EAST DIVN PATIALA	DS S/D DEVIAGARH	D189FL03	DIWAN WALA	AMR	OK	31.03.2023	AP 3Phase 3Wire	9148717	900-450/5	1.742		NA	Director/D			
B.7973	South	PATIALA	11KV	DS EAST DIVN PATIALA	DS S/D DEVIAGARH	D189FL14	SUNDER SINGH WALA	AMR	OK	31.03.2023	AP 3Phase 3Wire	34028	900-450/ 577/1-1-1	1.977		NA	Director/D			
B.7974	South	PATIALA	11KV	DS EAST DIVN PATIALA	DS S/D DEVIAGARH	D189FL13	HADANA	AMR	OK	31.03.2023	AP 3Phase 3Wire	34049	900-450/ 577/1-1-1	2.408		NA	Director/D			
B.7975	South	PATIALA	11KV	DS EAST DIVN PATIALA	DS S/D DEVIAGARH	D189FL05	GAGROLI	AMR	OK	31.03.2023	AP 3Phase 3Wire	9140719	900-450/5	2.479		NA	Director/D			
B.7976	South	PATIALA	11KV	DS EAST DIVN PATIALA	DS S/D DEVIAGARH	D189FL15	UPS PALAKHA	AMR	OK	31.03.2023	Category 5-UPS	1519369	900-450/5	3.491		NA	Director/D			
B.7977	South	PATIALA	11KV	DS EAST DIVN PATIALA	DS S/D DEVIAGARH	D189FL13	11 KV SHRI NAGAR	AMR	OK	31.03.2023	Category 1	11069775	Not installed	1.776		NA	Director/D			
B.7978	South	PATIALA	11KV	DS EAST DIVN PATIALA	DS S/D DEVIAGARH	D189FL10	11 KV SHRI NAGAR	AMR	OK	31.03.2023	AP 3Phase 3Wire	11069775	Not installed	1.970		NA	Director/D			
B.7979	South	PATIALA	11KV	DS EAST DIVN PATIALA	DS S/D DEVIAGARH	D189FL11	PANJETA	AMR	OK	31.03.2023	AP 3Phase 3Wire	9140720	Not installed	2.048		NA	Director/D			
B.7980	South	PATIALA	11KV	DS EAST DIVN PATIALA	DS S/D DEVIAGARH	D189FL03	UPPLI	AMR	OK	31.03.2023	AP 3Phase 3Wire	12479622	Not installed	2.086		NA	Director/D			
B.7981	South	PATIALA	11KV	DS EAST DIVN PATIALA	DS S/D DEVIAGARH	D189FL08	Thakargarh	AMR	OK	31.03.2023	AP 3Phase 3Wire	8222546	Not installed	2.206		NA	Director/D			
B.7982	South	PATIALA	11KV	DS EAST DIVN PATIALA	DS S/D DEVIAGARH	D189FL04	KHITHARH	AMR	OK	31.03.2023	AP 3Phase 3Wire	91403024	Not installed	2.316		NA	Director/D			
B.7983	South	PATIALA	11KV	DS EAST DIVN PATIALA	DS S/D DEVIAGARH	D189FL05	KHAKTAN	AMR	OK	31.03.2023	AP 3Phase 3Wire	3971	Not installed	2.404		NA	Director/D			
B.7984	South	PATIALA	11KV	DS EAST DIVN PATIALA	DS S/D DEVIAGARH	D189FL02	SHADIPUR	AMR	OK	31.03.2023	AP 3Phase 3Wire	8222938	Not installed	2.509		NA	Director/D			
B.7985	South	PATIALA	11KV	DS EAST DIVN PATIALA	DS S/D DEVIAGARH	D189FL01	URBAN BHUNERHERI	AMR	OK	31.03.2023	Category 1	4186548	Not installed	3.670		NA	Director/D			
B.7986	South	PATIALA	11KV	DS EAST DIVN PATIALA	DS S/D DEVIAGARH	D189FL12	UPS Prour	AMR	OK	31.03.2023	Category 5-UPS	36698	Not installed	4.396		NA	Director/D			
B.7987	South	PATIALA	11KV	DS EAST DIVN PATIALA	DS S/D DEVIAGARH	D189FL07	UPS AULPUR	AMR	OK	31.03.2023	Category 5-UPS	10252879	Not installed	6.474		NA	Director/D			
B.7988	South	PATIALA	11KV	DS EAST DIVN PATIALA	DS S/D DEVIAGARH	D153FL17	Sahibpura	AMR	OK	31.03.2023	AP 3Phase 3Wire	2068445	Not installed	1.092		NA	Director/D			
B.7989	South	PATIALA	11KV	DS EAST DIVN PATIALA	DS S/D DEVIAGARH	D153FL04	BHUNERHERI	AMR	OK	31.03.2023	AP 3Phase 3Wire	1116885	Not installed	1.161		NA	Director/D			
B.7990	South	PATIALA	11KV	DS EAST DIVN PATIALA	DS S/D DEVIAGARH	D153FL19	ALPUR SIKHAN	AMR	OK	31.03.2023	AP 3Phase 3Wire	12479452	Not installed	1.604		NA	Director/D			
B.7991	South	PATIALA	11KV	DS EAST DIVN PATIALA	DS S/D DEVIAGARH	D153FL07	WALIAN	AMR	OK	31.03.2023	AP 3Phase 3Wire	2067817	Not installed	1.903		NA	Director/D			
B.7992	South	PATIALA	11KV	DS EAST DIVN PATIALA	DS S/D DEVIAGARH	D153FL23	Bishangarh Jhungan	AMR	OK	31.03.2023	AP 3Phase 3Wire	12479624	Not installed	1.958		NA	Director/D			
B.7993	South	PATIALA	11KV	DS EAST DIVN PATIALA	DS S/D DEVIAGARH	D153FL10	JAWALAPUR	AMR	OK	31.03.2023	AP 3Phase 3Wire	98	Not installed	1.983		NA	Director/D			
B.7994	South	PATIALA	11KV	DS EAST DIVN PATIALA	DS S/D DEVIAGARH	D153FL09	GAGROLA	AMR	OK	31.03.2023	AP 3Phase 3Wire	9140636	Not installed	2.159		NA	Director/D			
B.7995	South	PATIALA	11KV	DS EAST DIVN PATIALA	DS S/D DEVIAGARH															

S.No	Zone	Circle	Voltage Level (kVA)	Division (kVA)	Sub-Division (kVA)	Feeder ID	Feeder Name	Feeder Metering Status (Metered/unmetered/AM/AMR)	Status of Meter (Functional/Non-Functional)	Metering Date (Date of last actual meter reading/communication)	Feeder Type (Agr/Industrial/Mixed)	Status of Communication			Period from 01.04.2021 to 31.03.2022				Sales	Remarks (Source of data)
												% data received through automatically by feeder AMR/AMI	Number of hours when meter was unable to communicate in overall	Total Number of hours in the period	Meter S.No	CT/PT ratio	Import (kWh)	Export (kWh)		
B.8021	South	PATIALA	11kV	DS EAST DIVN PATIALA	DS S/D KALYAN	D159FL11	Rambirpura	AMR	OK	31.03.2023	AP 3Phase 3Wire				9140750	Not installed	2,551	NA	Director/D	
B.8022	South	PATIALA	11kV	DS EAST DIVN PATIALA	DS S/D KALYAN	D159FL14	Bishanpur Channa	AMR	OK	31.03.2023	AP 3Phase 3Wire				9140746	Not installed	2,657	NA	Director/D	
B.8023	South	PATIALA	11kV	DS EAST DIVN PATIALA	DS S/D KALYAN	D159FL02	Wasidpur	AMR	OK	31.03.2023	AP 3Phase 3Wire				9140665	Not installed	3,283	NA	Director/D	
B.8024	South	PATIALA	11kV	DS EAST DIVN PATIALA	DS S/D KALYAN	D159FL07	Phasiana	AMR	OK	31.03.2023	Category 5 UPS				2064532	Not installed	12,027	NA	Director/D	
B.8025	South	PATIALA	11kV	DS EAST DIVN PATIALA	DS S/D KALYAN	D158FL11	station transformer raktra	AMR	OK	31.03.2023	Substation Transformer				3344	Not installed	0,055	NA	Director/D	
B.8026	South	PATIALA	11kV	DS EAST DIVN PATIALA	DS S/D KALYAN	D158FL17	Dera Kalyan	AMR	OK	31.03.2023	AP 3Phase 3Wire				34171	Not installed	1,490	NA	Director/D	
B.8027	South	PATIALA	11kV	DS EAST DIVN PATIALA	DS S/D KALYAN	D158FL05	Hirdapur	AMR	OK	31.03.2023	AP 3Phase 3Wire				9140735	Not installed	1,783	NA	Director/D	
B.8028	South	PATIALA	11kV	DS EAST DIVN PATIALA	DS S/D KALYAN	D158FL13	Raktra	AMR	OK	31.03.2023	AP 3Phase 3Wire				9140734	Not installed	2,103	NA	Director/D	
B.8029	South	PATIALA	11kV	DS EAST DIVN PATIALA	DS S/D KALYAN	D158FL11	Rangrah Channa	AMR	OK	31.03.2023	AP 3Phase 3Wire				9140708	Not installed	2,474	NA	Director/D	
B.8030	South	PATIALA	11kV	DS EAST DIVN PATIALA	DS S/D KALYAN	D158FL20	11 KV Daghbat	AMR	OK	31.03.2023	AP 3Phase 4Wire				4410	Not installed	2,474	NA	Director/D	
B.8031	South	PATIALA	11kV	DS EAST DIVN PATIALA	DS S/D KALYAN	D158FL03	Kalyan	AMR	OK	31.03.2023	AP 3Phase 3Wire				9140709	Not installed	2,475	NA	Director/D	
B.8032	South	PATIALA	11kV	DS EAST DIVN PATIALA	DS S/D KALYAN	D158FL04	Dhablan	AMR	OK	31.03.2023	AP 3Phase 3Wire				9140732	Not installed	2,620	NA	Director/D	
B.8033	South	PATIALA	11kV	DS EAST DIVN PATIALA	DS S/D KALYAN	D158FL16	Shalbura	AMR	OK	31.03.2023	AP 3Phase 3Wire				34011	Not installed	3,228	NA	Director/D	
B.8034	South	PATIALA	11kV	DS EAST DIVN PATIALA	DS S/D KALYAN	D158FL06	Sugar Mill	AMR	OK	31.03.2023	Category 1				204455	Not installed	5,874	NA	Director/D	
B.8035	South	PATIALA	11kV	DS EAST DIVN PATIALA	DS S/D KALYAN	D158FL02	UPS Raktra	AMR	OK	31.03.2023	Category 5 UPS				2047093	Not installed	6,198	NA	Director/D	
B.8037	South	PATIALA	11kV	DS EAST DIVN PATIALA	DS S/D KALYAN	D159FL06	Dhablan-2	AMR	OK	31.03.2023	AP 3Phase 3Wire				2765	1200/577/1-1-1	2,845	NA	Director/D	
B.8038	South	PATIALA	11kV	DS EAST DIVN PATIALA	DS S/D KALYAN	D159FL15	UPS Kheri muslimania	AMR	OK	31.03.2023	Category 5-UPS				3611	1200/577/1-1-1	3,889	NA	Director/D	
B.8039	South	PATIALA	11kV	DS EAST DIVN PATIALA	DS S/D Rehah jagir	K157FL08	11 KV AP Mallamra	AMR	OK	31.03.2023	AP 3Phase 3Wire				5291	900-450/577/1-1-1	1,117	NA	Director/D	
B.8040	South	PATIALA	11kV	DS EAST DIVN PATIALA	DS S/D Rehah jagir	K157FL01	11 KV Feren Simalgh Wala	AMR	OK	31.03.2023	AP 3Phase 3Wire				4764	900-450/577/1-1-1	1,243	NA	Director/D	
B.8041	South	PATIALA	11kV	DS EAST DIVN PATIALA	DS S/D Rehah jagir	K157FL01	11 KV Pathan Majra	AMR	OK	31.03.2023	AP 3Phase 3Wire				4566	900-450/577/1-1-1	1,254	NA	Director/D	
B.8042	South	PATIALA	11kV	DS EAST DIVN PATIALA	DS S/D Rehah jagir	K157FL02	11 KV Burai Wala	AMR	OK	31.03.2023	AP 3Phase 3Wire				4390	900-450/577/1-1-1	1,394	NA	Director/D	
B.8043	South	PATIALA	11kV	DS EAST DIVN PATIALA	DS S/D Rehah jagir	K157FL03	11 Sadhu Nagar	AMR	OK	31.03.2023	AP 3Phase 3Wire				4392	900-450/577/1-1-1	2,251	NA	Director/D	
B.8044	South	PATIALA	11kV	DS EAST DIVN PATIALA	DS S/D Rehah jagir	K157FL09	11 KV UPS Kheri Raju	AMR	OK	31.03.2023	Category 5-UPS				5716	900-450/577/1-1-1	5,188	NA	Director/D	
B.8045	South	PATIALA	11kV	DS EAST DIVN PATIALA	DS S/D Rehah jagir	K157FL10	UPS Gharam	AMR	OK	31.03.2023	Category 5-UPS				5399	900-450/577/1-1-1	6,189	NA	Director/D	
B.8046	South	PATIALA	11kV	DS EAST DIVN PATIALA	DS S/D Rehah jagir	D153FL20	JALAKHIA	AMR	OK	31.03.2023	AP 3Phase 3Wire				45204	Not installed	0,291	NA	Director/D	
B.8047	South	PATIALA	11kV	DS EAST DIVN PATIALA	DS S/D Rehah jagir	D153FL15	KISHANPUR	AMR	OK	31.03.2023	AP 3Phase 3Wire				5437500	Not installed	0,753	NA	Director/D	
B.8048	South	PATIALA	11kV	DS EAST DIVN PATIALA	DS S/D Rehah jagir	D152FL03	MASHINGAN	AMR	OK	31.03.2023	AP 3Phase 3Wire				106	Not installed	1,903	NA	Director/D	
B.8049	South	PATIALA	11kV	DS EAST DIVN PATIALA	DS S/D Rehah jagir	D152FL12	JULKA	AMR	OK	31.03.2023	AP 3Phase 3Wire				65	Not installed	1,918	NA	Director/D	
B.8050	South	PATIALA	11kV	DS EAST DIVN PATIALA	DS S/D Rehah jagir	D152FL05	BANGRA	AMR	OK	31.03.2023	AP 3Phase 3Wire				7042822	Not installed	1,919	NA	Director/D	
B.8051	South	PATIALA	11kV	DS EAST DIVN PATIALA	DS S/D Rehah jagir	D152FL21	MEHON	AMR	OK	31.03.2023	AP 3Phase 3Wire				2066723	Not installed	2,048	NA	Director/D	
B.8052	South	PATIALA	11kV	DS EAST DIVN PATIALA	DS S/D Rehah jagir	D152FL13	BIHAL	AMR	OK	31.03.2023	AP 3Phase 3Wire				108	Not installed	2,105	NA	Director/D	
B.8053	South	PATIALA	11kV	DS EAST DIVN PATIALA	DS S/D Rehah jagir	D152FL18	CHUHAT	AMR	OK	31.03.2023	AP 3Phase 3Wire				12479736	Not installed	2,169	NA	Director/D	
B.8054	South	PATIALA	11kV	DS EAST DIVN PATIALA	DS S/D Rehah jagir	D152FL24	11 KV Tehsil Wala	AMR	OK	31.03.2023	Category 1				3638	Not installed	4,522	NA	Director/D	
B.8055	South	PATIALA	11kV	DS EAST DIVN PATIALA	DS S/D Rehah jagir	D152FL06	DUDHAN	AMR	OK	31.03.2023	Category 5-UPS				9140766	Not installed	10,760	NA	Director/D	
B.8056	South	PATIALA	11kV	DS EAST DIVN PATIALA	DS S/D Rehah jagir	D152FL11	UPS 2	AMR	OK	31.03.2023	Category 5-UPS				99	Not installed	15,155	NA	Director/D	
B.8057	South	PATIALA	11kV	DS EAST DIVN PATIALA	DS S/D Rehah jagir	D152FL19	ADALTIWALA	AMR	OK	31.03.2023	AP 3Phase 3Wire				11520891	Not installed	1,182	NA	Director/D	
B.8058	South	PATIALA	11kV	DS EAST DIVN PATIALA	DS S/D Rehah jagir	D152FL10	Aujha	AMR	OK	31.03.2023	AP 3Phase 3Wire				4187195	Not installed	1,469	NA	Director/D	
B.8059	South	PATIALA	11kV	DS EAST DIVN PATIALA	DS S/D Rehah jagir	D152FL02	ALPUR	AMR	OK	31.03.2023	AP 3Phase 3Wire				9154321	Not installed	1,661	NA	Director/D	
B.8060	South	PATIALA	11kV	DS EAST DIVN PATIALA	DS S/D Rehah jagir	D152FL05	RATTA KHERA	AMR	OK	31.03.2023	AP 3Phase 3Wire				9140767	Not installed	1,688	NA	Director/D	
B.8061	South	PATIALA	11kV	DS EAST DIVN PATIALA	DS S/D Rehah jagir	D152FL17	SUREG SINGH WALA	AMR	OK	31.03.2023	AP 3Phase 3Wire				2067176	Not installed	1,718	NA	Director/D	
B.8062	South	PATIALA	11kV	DS EAST DIVN PATIALA	DS S/D Rehah jagir	D152FL03	MOHAH GAHR	AMR	OK	31.03.2023	AP 3Phase 3Wire				9140724	Not installed	1,999	NA	Director/D	
B.8063	South	PATIALA	11kV	DS EAST DIVN PATIALA	DS S/D Rehah jagir	D152FL14	Chandpur	AMR	OK	31.03.2023	AP 3Phase 3Wire				10259214	Not installed	2,043	NA	Director/D	
B.8064	South	PATIALA	11kV	DS EAST DIVN PATIALA	DS S/D Rehah jagir	D154FL08	MUKHAMALPUR	AMR	OK	31.03.2023	AP 3Phase 3Wire				9140770	Not installed	2,062	NA	Director/D	
B.8065	South	PATIALA	11kV	DS EAST DIVN PATIALA	DS S/D Rehah jagir	D152FL06	ISHERHERI	AMR	OK	31.03.2023	AP 3Phase 3Wire				9140768	Not installed	2,069	NA	Director/D	
B.8066	South	PATIALA	11kV	DS EAST DIVN PATIALA	DS S/D Rehah jagir	D152FL07	AHRU KALAN	AMR	OK	31.03.2023	AP 3Phase 3Wire				9140769	Not installed	2,174	NA	Director/D	
B.8067	South	PATIALA	11kV	DS EAST DIVN PATIALA	DS S/D Rehah jagir	D152FL01	FRIOPUR	AMR	OK	31.03.2023	AP 3Phase 3Wire				9140725	Not installed	2,233	NA	Director/D	
B.8068	South	PATIALA	11kV	DS EAST DIVN PATIALA	DS S/D Rehah jagir	D152FL18	JALERSHA	AMR	OK	31.03.2023	AP 3Phase 3Wire				2046966	Not installed	2,264	NA	Director/D	
B.8069	South	PATIALA	11kV	DS EAST DIVN PATIALA	DS S/D Rehah jagir	D152FL04	MAGGAR SAHB	AMR	OK	31.03.2023	Category 5-UPS				6511	Not installed	6,795	NA	Director/D	
B.8070	South	PATIALA	11kV	DS EAST DIVN PATIALA	DS S/D Rehah jagir	D152FL08	JPESHKANS	AMR	OK	31.03.2023	Category 5-UPS				9154414	Not installed	9,278	NA	Director/D	
B.8071	South	PATIALA	11kV	DS EAST DIVN PATIALA	DS S/D Rehah jagir	D153FL02	GHRAM	AMR	OK	31.03.2023	AP 3Phase 3Wire				15199026	Not installed	0,660	NA	Director/D	
B.8072	South	PATIALA	11kV	DS EAST DIVN PATIALA	DS S/D Rehah jagir	D153FL03	JODHPUR	AMR	OK	31.03.2023	AP 3Phase 3Wire				9140649	Not installed	1,743	NA	Director/D	
B.8073	South	PATIALA	11kV	DS EAST DIVN PATIALA	DS S/D Rehah jagir	D153FL13	BAJWAR	AMR	OK	31.03.2023	AP 3Phase 3Wire				34178	Not installed	1,854	NA	Director/D	
B.8074	South	PATIALA	11kV	DS EAST DIVN PATIALA	DS S/D Rehah jagir	D153FL14	11 KV BIBIPUR	AMR	OK	31.03.2023	AP 3Phase 3Wire				914714	Not installed	1,929	NA	Director/D	
B.8075	South	PATIALA	11kV	DS EAST DIVN PATIALA	DS S/D Rehah jagir	D153FL10	RACHAN	AMR	OK	31.03.2023	AP 3Phase 3Wire				9534355	Not installed	2,482	NA	Director/D	
B.8076	South	PATIALA	11kV	DS EAST DIVN PATIALA	DS S/D Rehah jagir	D153FL04	NANDGARH	AMR	OK	31.03.2023	AP 3Phase 3Wire				9140648	Not installed	2,526	NA	Director/D	
B.8077	South	PATIALA	11kV	DS EAST DIVN PATIALA	DS S/D Rehah jagir	D153FL01	FRANCEWALA	AMR	OK	31.03.2023	AP 3Phase 3Wire				9140647	Not installed	2,583	NA	Director/D	
B.8078	South	PATIALA	11kV	DS EAST DIVN PATIALA	DS S/D Rehah jagir	D153FL11	11 KV KHATOLI	AMR	OK	31.03.2023	AP 3Phase 3Wire				36949	Not installed	2,708	NA	Director/D	
B.8079	South	PATIALA	11kV	DS EAST DIVN PATIALA	DS S/D Rehah jagir	D153FL09	SADANPUR	AMR	OK	31.03.2023	AP 3Phase 3Wire				16193784	Not installed	2,743	NA	Director/D	
B.8080	South	PATIALA	11kV	DS EAST DIVN PATIALA	DS S/D Rehah jagir	D153FL08	JALABAD	AMR	OK	31.03.2023	AP 3Phase 3Wire				16199245	Not installed	3,103	NA	Director/D	
B.8081	South	PATIALA	11kV	DS EAST DIVN PATIALA	DS S/D Rehah jagir	D153FL14	DEVINGAR	AMR	OK	31.03.2023	AP 3Phase 3Wire				36708	Not installed	3,793	NA	Director/D	
B.8082	South	PATIALA	11kV	DS EAST DIVN PATIALA	DS S/D Rehah jagir	D153FL07	GANESHPUR	NON AMR	OK	31.03.2023	AP 3Phase 3Wire				9140646	Not installed	3,983	NA	Director/D	
B.8083	South	PATIALA	11kV	DS EAST DIVN PATIALA	DS S/D Rehah jagir	D153FL05	BOLI SAHIB	AMR	OK	31.03.2023	Category 5-UPS				5437725	Not installed	9,700	NA	Director/D	
B.8084	South	PATIALA	11kV	DS EAST DIVN PATIALA	DS S/D Rehah jagir	D153FL06	ROSHANPUR	AMR	OK	31.03.2023	Category 5-UPS				1027393	Not installed	12,339	NA	Director/D	
B.8085	South	PATIALA	11kV	DS EAST DIVN PATIALA	DS S/D Sanour	D154FL04	11 KV Rhenan	AMR	OK	31.03.2023	AP 3Phase 3Wire				12479301	Not installed	0,000	NA	Director/D	
B.8086	South	PATIALA	11kV	DS EAST DIVN PATIALA	DS S/D Sanour	D188FL02	MANDI	AMR	OK	31.03.2023	AP 3Phase 3Wire				2067540	900-450/577	1,466	NA	Director/D	
B.8087	South	PATIALA	11kV	DS EAST DIVN PATIALA	DS S/D Sanour	D188FL05	KARANPUR	AMR	OK	31.03.2023	AP 3Phase 3Wire				9140718	900-450/577	1,468	NA	Director/D	
B.8088	South	PATIALA	11kV	DS EAST DIVN PATIALA	DS S/D Sanour	D188FL01	URBAN BANKHER	AMR	OK	31.03.2023	Category 1				2068202	900-450/577	1,505	NA	Director/D	
B.8089	South	PATIALA	11kV	DS EAST DIVN PATIALA	DS S/D Sanour	D188FL11	PUR	AMR	OK	31.03.2023	AP 3Phase 3Wire				11052016	900-450/577/1-1-1				

S.No	Zone	Circle	Voltage Level (kVA)	Division (kVA)	Sub-Division (kVA)	Feeder ID	Feeder Name	Feeder Metering Status (Metered/unmetered/AMR/AMI)	Status of Meter (Functional/Non-Functional)	Metering Date (Date of last actual meter reading/communication)	Feeder Type (Agr/Industrial/Mixed)	Status of Communication			Period from 01.04.2021 to 31.03.2022				Sales	Remarks (Source of data)
												% data received through automatically if feeder AMR/AMI	Number of hours when meter was unable to communicate in overall	Total Number of hours in the period	Meter S.No	CT/PT ratio	Import (kWh)	Export (kWh)		
B.8118	South	PATIALA	11KV	DS EAST DIVN PATIALA	DS S/D Sanour	D054F04	URBAN NANAKSAR	AMR	OK	31.03.2023	Category 1				16194378	Not installed	10.765	NA	Director/D	
B.8119	South	PATIALA	11KV	DS EAST DIVN PATIALA	DS S/D Sanour	D054F06	URBAN SANOUR	AMR	OK	31.03.2023	Category 1				6676951	Not installed	11.681	NA	Director/D	
B.8120	South	PATIALA	11KV	DS S/U DIVN PATIALA	DS S/D Bahadurgarh	B0153FL14	SUB STATION	AMR	OK	31.03.2023	Category 4				916350	1200/577/1-1-1	0.126	NA	Director/D	
B.8121	South	PATIALA	11KV	DS S/U DIVN PATIALA	DS S/D Bahadurgarh	B0153FL11	GAUNE PUR	AMR	OK	31.03.2023	AP 3Phase 3Wire				9334439	1200/577/1-1-1	1.538	NA	Director/D	
B.8122	South	PATIALA	11KV	DS S/U DIVN PATIALA	DS S/D Bahadurgarh	B0153FL12	ALAMPUR	NON AMR	OK	31.03.2023	AP 3Phase 3Wire				15196064	1200/577/1-1-1	1.650	NA	Director/D	
B.8123	South	PATIALA	11KV	DS S/U DIVN PATIALA	DS S/D Bahadurgarh	B0153FL05	MOHPATPUR	AMR	OK	31.03.2023	AP 3Phase 3Wire				8222756	1200/577/1-1-1	1.664	NA	Director/D	
B.8124	South	PATIALA	11KV	DS S/U DIVN PATIALA	DS S/D Bahadurgarh	B0153FL08	FATEHPUR	NON AMR	OK	31.03.2023	AP 3Phase 3Wire				2068393	1200/577/1-1-1	1.982	NA	Director/D	
B.8125	South	PATIALA	11KV	DS S/U DIVN PATIALA	DS S/D Bahadurgarh	B0153FL04	DAUN KALAN	AMR	OK	31.03.2023	AP 3Phase 3Wire				8222790	1200/577/1-1-1	2.612	NA	Director/D	
B.8126	South	PATIALA	11KV	DS S/U DIVN PATIALA	DS S/D Bahadurgarh	B0153FL09	UPS 3 WIRE	AMR	OK	31.03.2023	Category 5-UPS				9334439	1200/577/1-1-1	6.214	NA	Director/D	
B.8127	South	PATIALA	11KV	DS S/U DIVN PATIALA	DS S/D Bahadurgarh	DPN9FL02	AP BILDHANPUR	AMR	OK	31.03.2023	AP 3Phase 3Wire				12479298	Not installed	0.450	NA	Director/D	
B.8128	South	PATIALA	11KV	DS S/U DIVN PATIALA	DS S/D Bahadurgarh	DPN9FL01	UPS CHAPPAR	AMR	OK	31.03.2023	Category 5-UPS				12479297	Not installed	0.715	NA	Director/D	
B.8129	South	PATIALA	11KV	DS S/U DIVN PATIALA	DS S/D Bahadurgarh	DPN9FL03	AP CHAPPAR	AMR	OK	31.03.2023	AP 3Phase 3Wire				12479300	Not installed	1.059	NA	Director/D	
B.8130	South	PATIALA	11KV	DS S/U DIVN PATIALA	DS S/D Bahadurgarh	D016ZF17	Substation Bhadurgarh	AMR	OK	31.03.2023	Substation Transformer				1005341	Not installed	0.013	NA	Director/D	
B.8131	South	PATIALA	11KV	DS S/U DIVN PATIALA	DS S/D Bahadurgarh	D016FL1	NEXGEN FEEDER	AMR	OK	31.03.2023	Category 4				12479341	Not installed	0.753	NA	Director/D	
B.8132	South	PATIALA	11KV	DS S/U DIVN PATIALA	DS S/D Bahadurgarh	D016FL16	CHAPPAR	AMR	OK	31.03.2023	AP 3Phase 3Wire				36975	Not installed	1.289	NA	Director/D	
B.8133	South	PATIALA	11KV	DS S/U DIVN PATIALA	DS S/D Bahadurgarh	D016FL05	KALU	AMR	OK	31.03.2023	AP 3Phase 3Wire				2067633	Not installed	2.080	NA	Director/D	
B.8134	South	PATIALA	11KV	DS S/U DIVN PATIALA	DS S/D Bahadurgarh	D016ZF04	SEAL	AMR	OK	31.03.2023	AP 3Phase 3Wire				8222758	Not installed	2.767	NA	Director/D	
B.8135	South	PATIALA	11KV	DS S/U DIVN PATIALA	DS S/D Bahadurgarh	D016FL02	MILKFOOD	AMR	OK	31.03.2023	Category 4				2066615	Not installed	2.772	NA	Director/D	
B.8136	South	PATIALA	11KV	DS S/U DIVN PATIALA	DS S/D Bahadurgarh	D016FL09	ANOUR	AMR	OK	31.03.2023	AP 3Phase 3Wire				8222766	Not installed	3.286	NA	Director/D	
B.8137	South	PATIALA	11KV	DS S/U DIVN PATIALA	DS S/D Bahadurgarh	D016ZF12	DAUN KALAN B Garh	AMR	OK	31.03.2023	AP 3Phase 3Wire				8222859	Not installed	3.323	NA	Director/D	
B.8138	South	PATIALA	11KV	DS S/U DIVN PATIALA	DS S/D Bahadurgarh	D016FL06	NOUR KHRIAN	AMR	OK	31.03.2023	AP 3Phase 3Wire				8222850	Not installed	5.251	NA	Director/D	
B.8139	South	PATIALA	11KV	DS S/U DIVN PATIALA	DS S/D Bahadurgarh	D016ZF07	BHATMAIRA	AMR	OK	31.03.2023	AP 3Phase 3Wire				8222848	Not installed	5.886	NA	Director/D	
B.8140	South	PATIALA	11KV	DS S/U DIVN PATIALA	DS S/D Bahadurgarh	D016ZF11	LAKHOMAIRA	AMR	OK	31.03.2023	AP 3Phase 3Wire				8222759	Not installed	7.021	NA	Director/D	
B.8141	South	PATIALA	11KV	DS S/U DIVN PATIALA	DS S/D Bahadurgarh	D016FL13	BANK (BAHADURGARH 1)	AMR	OK	31.03.2023	Category 1				12479632	Not installed	8.137	NA	Director/D	
B.8142	South	PATIALA	11KV	DS S/U DIVN PATIALA	DS S/D Bahadurgarh	D016FL15	BANK FEEDER (UPS - 2)	AMR	OK	31.03.2023	Category 5-UPS				7335667	Not installed	9.206	NA	Director/D	
B.8143	South	PATIALA	11KV	DS S/U DIVN PATIALA	DS S/D Bahadurgarh	D016FL08	URBAN ESTATE	AMR	OK	31.03.2023	Category 1				5385193	Not installed	10.031	NA	Director/D	
B.8144	South	PATIALA	11KV	DS S/U DIVN PATIALA	DS S/D Bahadurgarh	D016FL03	UPS 1	AMR	OK	31.03.2023	Category 5-UPS				2067438	Not installed	12.201	NA	Director/D	
B.8145	South	PATIALA	11KV	DS S/U DIVN PATIALA	DS S/D Bahadurgarh	D016ZF10	BAHADURGARH	Not available	OK	31.03.2023	Category 1				2066765	Not installed	16.017	NA	Director/D	
B.8146	South	PATIALA	66KV	DS S/U DIVN PATIALA	DS S/D Bahadurgarh	D016DL02	66 KV ESCORTS	AMR	OK	31.03.2023	Category 4				Not available	Not available	53.288	NA	Director/D	
B.8147	South	PATIALA	11KV	DS S/U DIVN PATIALA	DS S/D Balbehra	B0155FL08	GHECHA (KAMALPUR)	AMR	OK	31.03.2023	AP 3Phase 3Wire				9140743	Not installed	2.808	NA	Director/D	
B.8148	South	PATIALA	11KV	DS S/U DIVN PATIALA	DS S/D Balbehra	D016FL01	SAGA GUJIAN	NON AMR	OK	31.03.2023	AP 3Phase 3Wire				8223429	Not installed	2.118	NA	Director/D	
B.8149	South	PATIALA	11KV	DS S/U DIVN PATIALA	DS S/D Balbehra	D016FL17	Juidan	AMR	OK	31.03.2023	AP 3Phase 3Wire				236725	Not installed	2.154	NA	Director/D	
B.8150	South	PATIALA	11KV	DS S/U DIVN PATIALA	DS S/D Balbehra	D0163FL14	CHURASO	AMR	OK	31.03.2023	AP 3Phase 3Wire				6740700	Not installed	2.411	NA	Director/D	
B.8151	South	PATIALA	11KV	DS S/U DIVN PATIALA	DS S/D Balbehra	D0163FL12	ALUPUR	AMR	OK	31.03.2023	AP 3Phase 3Wire				2067418	Not installed	2.465	NA	Director/D	
B.8152	South	PATIALA	11KV	DS S/U DIVN PATIALA	DS S/D Balbehra	D016FL11	DAKALA	AMR	OK	31.03.2023	AP 3Phase 3Wire				9140888	Not installed	2.502	NA	Director/D	
B.8153	South	PATIALA	11KV	DS S/U DIVN PATIALA	DS S/D Balbehra	D016FL09	DADDA	AMR	OK	31.03.2023	AP 3Phase 3Wire				15193845	Not installed	2.548	NA	Director/D	
B.8154	South	PATIALA	11KV	DS S/U DIVN PATIALA	DS S/D Balbehra	D0163FL13	SALHAN	AMR	OK	31.03.2023	AP 3Phase 3Wire				9140630	Not installed	2.604	NA	Director/D	
B.8155	South	PATIALA	11KV	DS S/U DIVN PATIALA	DS S/D Balbehra	D016FL08	SALEMUR	AMR	OK	31.03.2023	AP 3Phase 3Wire				15194701	Not installed	4.502	NA	Director/D	
B.8156	South	PATIALA	11KV	DS S/U DIVN PATIALA	DS S/D Balbehra	D016FL02	KARTARPUR	AMR	OK	31.03.2023	AP 3Phase 3Wire				8223430	Not installed	4.616	NA	Director/D	
B.8157	South	PATIALA	11KV	DS S/U DIVN PATIALA	DS S/D Balbehra	D0163FL03	RAMNAGAR	AMR	OK	31.03.2023	AP 3Phase 3Wire				9140887	Not installed	4.792	NA	Director/D	
B.8158	South	PATIALA	11KV	DS S/U DIVN PATIALA	DS S/D Balbehra	D0163FL10	BATHOI	AMR	OK	31.03.2023	AP 3Phase 3Wire				15194678	Not installed	5.033	NA	Director/D	
B.8159	South	PATIALA	11KV	DS S/U DIVN PATIALA	DS S/D Balbehra	D0163FL05	KARNALI	AMR	OK	31.03.2023	AP 3Phase 3Wire				15193901	Not installed	5.242	NA	Director/D	
B.8160	South	PATIALA	11KV	DS S/U DIVN PATIALA	DS S/D Balbehra	D0163FL18	NOGAWANA	AMR	OK	31.03.2023	Category 5-UPS				8223388	Not installed	5.537	NA	Director/D	
B.8161	South	PATIALA	11KV	DS S/U DIVN PATIALA	DS S/D Balbehra	D0163FL04	BALBERA	NON AMR	OK	31.03.2023	Category 1				6761935	Not installed	9.238	NA	Director/D	
B.8162	South	PATIALA	11KV	DS S/U DIVN PATIALA	DS S/D Balbehra	D0163FL16	ZAFFARPUR UPS	NON AMR	OK	31.03.2023	Category 5-UPS				954426	Not installed	9.992	NA	Director/D	
B.8163	South	PATIALA	11KV	DS S/U DIVN PATIALA	DS S/D Balbehra	D0163FL15	DULBA	AMR	OK	31.03.2023	Category 5-UPS				9140886	Not installed	11.172	NA	Director/D	
B.8164	South	PATIALA	11KV	DS S/U DIVN PATIALA	DS S/D Balbehra	D0163FL14	MAJAL KALAN	AMR	OK	31.03.2023	AP 3Phase 3Wire				12479337	Not installed	1.989	NA	Director/D	
B.8165	South	PATIALA	11KV	DS S/U DIVN PATIALA	DS S/D Balbehra	D0163FL05	MANSAPUR	AMR	OK	31.03.2023	AP 3Phase 3Wire				8223809	Not installed	2.716	NA	Director/D	
B.8166	South	PATIALA	11KV	DS S/U DIVN PATIALA	DS S/D Balbehra	D0163FL09	BILASPUR	AMR	OK	31.03.2023	AP 3Phase 3Wire				34211	Not installed	2.774	NA	Director/D	
B.8167	South	PATIALA	11KV	DS S/U DIVN PATIALA	DS S/D Balbehra	D0163FL04	BATHOI	AMR	OK	31.03.2023	AP 3Phase 3Wire				8223884	Not installed	3.080	NA	Director/D	
B.8168	South	PATIALA	11KV	DS S/U DIVN PATIALA	DS S/D Balbehra	D016FL07	Substation Randhawa	AMR	OK	31.03.2023	Substation Transformer				10288329	Not installed	0.090	NA	Director/D	
B.8169	South	PATIALA	11KV	DS S/U DIVN PATIALA	DS S/D Balbehra	D0163FL06	RANDHAWA	AMR	OK	31.03.2023	Category 1				8223365	400-200/5-5	0.881	NA	Director/D	
B.8170	South	PATIALA	11KV	DS S/U DIVN PATIALA	DS S/D Balbehra	D016FL15	Nawagaon	AMR	OK	31.03.2023	AP 3Phase 3Wire				4325	Not installed	1.581	NA	Director/D	
B.8171	South	PATIALA	11KV	DS S/U DIVN PATIALA	DS S/D Balbehra	D0163FL09	KARPUR	AMR	OK	31.03.2023	AP 3Phase 3Wire				2067217	400-200/5-5	1.983	NA	Director/D	
B.8172	South	PATIALA	11KV	DS S/U DIVN PATIALA	DS S/D Balbehra	D0163FL1	BAL FARM	AMR	OK	31.03.2023	AP 3Phase 3Wire				13100584	Not installed	1.640	NA	Director/D	
B.8173	South	PATIALA	11KV	DS S/U DIVN PATIALA	DS S/D Balbehra	FLO2D196	Bilpur	AMR	OK	31.03.2023	AP 3Phase 3Wire				10288348	Not installed	1.796	NA	Director/D	
B.8174	South	PATIALA	11KV	DS S/U DIVN PATIALA	DS S/D Balbehra	D0163FL13	DHANORI 1	AMR	OK	31.03.2023	AP 3Phase 3Wire				15196060	400-200/5-5	1.858	NA	Director/D	
B.8175	South	PATIALA	11KV	DS S/U DIVN PATIALA	DS S/D Balbehra	FLO1D196	kamalpur	AMR	OK	31.03.2023	AP 3Phase 3Wire				10288365	Not installed	1.950	NA	Director/D	
B.8176	South	PATIALA	11KV	DS S/U DIVN PATIALA	DS S/D Balbehra	D0163FL13	DHANORI	AMR	OK	31.03.2023	AP 3Phase 3Wire				13100586	Not installed	2.260	NA	Director/D	
B.8177	South	PATIALA	11KV	DS S/U DIVN PATIALA	DS S/D Balbehra	D016FL21	RANDHAWA AP	AMR	OK	31.03.2023	AP 3Phase 3Wire				1527336	400-200/5-5	2.582	NA	Director/D	
B.8178	South	PATIALA	11KV																	

S.No	Zone	Circle	Voltage Level (kVA)	Division (kVA)	Sub-Division (kVA)	Feeder ID	Feeder Name	Feeder Metering Status (Metered/unmetered/AMR/AMI)	Status of Meter (Functional/Non-Functional)	Metering Date (Date of last actual meter reading/communication)	Feeder Type (Agr/Industrial/Mixed)	Status of Communication			Period from 01.04.2021 to 31.03.2022				Sales	Remarks (Source of data)
												% data received through automatically if feeder AMR/AMI	Number of hours when meter was unable to communicate in overall	Total Number of hours in the period	Meter S.No	CT/PT ratio	Import (kWh)	Export (kWh)		
B.8215	South	PATIALA	11KV	DS S/U DIVN PATIALA	DS S/D Ghanaur -2	D187F02	KOLEHMAIRA (D-GARH)	AMR	OK	31.03.2023	AP 3Phase 3Wire				9140620	Not installed	2.316	NA	Director/D	
B.8216	South	PATIALA	11KV	DS S/U DIVN PATIALA	DS S/D Ghanaur -2	D187F01	KUTHAKHERI (D-GARH)	AMR	OK	31.03.2023	AP 3Phase 3Wire				9140618	Not installed	2.595	NA	Director/D	
B.8217	South	PATIALA	11KV	DS S/U DIVN PATIALA	DS S/D Ghanaur -2	D187FL10	HARIPALUR UPS	AMR	OK	31.03.2023	Category 5-UPS				9534378	Not installed	9.635	NA	Director/D	
B.8218	South	PATIALA	11KV	DS S/U DIVN PATIALA	DS S/D Ghanaur -2	D187FL11	MAGGAR	AMR	OK	31.03.2023	AP 3Phase 3Wire				4909	Not installed	1.764	NA	Director/D	
B.8219	South	PATIALA	11KV	DS S/U DIVN PATIALA	DS S/D Ghanaur -2	D16GFL12	KOLEHMAIRA (GANOUR)	AMR	OK	31.03.2023	AP 3Phase 3Wire				2047050	Not installed	1.845	NA	Director/D	
B.8220	South	PATIALA	11KV	DS S/U DIVN PATIALA	DS S/D Ghanaur -2	D16GFL27	LANJA	AMR	OK	31.03.2023	AP 3Phase 3Wire				3554	Not installed	1.930	NA	Director/D	
B.8221	South	PATIALA	11KV	DS S/U DIVN PATIALA	DS S/D Ghanaur -2	D16GFL08	MANOLI	AMR	OK	31.03.2023	AP 3Phase 3Wire				76796	Not installed	2.099	NA	Director/D	
B.8222	South	PATIALA	11KV	DS S/U DIVN PATIALA	DS S/D Ghanaur -2	D16GFL04	KUTHAKHERI (GANOUR)	AMR	OK	31.03.2023	AP 3Phase 3Wire				9140556	Not installed	2.393	NA	Director/D	
B.8223	South	PATIALA	11KV	DS S/U DIVN PATIALA	DS S/D Ghanaur -2	D16GFL07	HARIPALUR	AMR	OK	31.03.2023	AP 3Phase 3Wire				23794	Not installed	2.476	NA	Director/D	
B.8224	South	PATIALA	11KV	DS S/U DIVN PATIALA	DS S/D Ghanaur -2	D16GFL14	SALEM PUR	AMR	OK	31.03.2023	AP 3Phase 3Wire				34180	Not installed	2.768	NA	Director/D	
B.8225	South	PATIALA	11KV	DS S/U DIVN PATIALA	DS S/D Ghanaur -2	D16GFL	TIWANA	AMR	OK	31.03.2023	AP 3Phase 3Wire				36771	Not installed	3.013	NA	Director/D	
B.8226	South	PATIALA	11KV	DS S/U DIVN PATIALA	DS S/D Ghanaur -2	D16GFL26	AMARA BREWERIES	AMR	OK	31.03.2023	Category 1				3355	Not installed	4.698	NA	Director/D	
B.8227	South	PATIALA	11KV	DS S/U DIVN PATIALA	DS S/D Ghanaur -2	D16GFL13	UPS	AMR	OK	31.03.2023	Category 5-UPS				736590	Not installed	5.416	NA	Director/D	
B.8228	South	PATIALA	11KV	DS S/U DIVN PATIALA	DS S/D Ghanaur -2	D16GFL16	UPS RUKKI	AMR	OK	31.03.2023	Category 5-UPS				5988	Not installed	10.341	NA	Director/D	
B.8229	South	PATIALA	11KV	DS S/U DIVN PATIALA	DS S/D Reektheri	D163FL07	11KV RATTANGARH	AMR	OK	31.03.2023	AP 3Phase 3Wire				9334562	1200/577/1-1	1.860	NA	Director/D	
B.8230	South	PATIALA	11KV	DS S/U DIVN PATIALA	DS S/D Reektheri	B153FL19	11KV MANAKPUR	NON AMR	OK	31.03.2023	AP 3Phase 3Wire				3873	1200/577/1-1	1.916	NA	Director/D	
B.8231	South	PATIALA	11KV	DS S/U DIVN PATIALA	DS S/D Reektheri	B153FL03	11KV BHAHPUR	AMR	OK	31.03.2023	AP 3Phase 3Wire				8222729	1200/577/1-1	2.116	NA	Director/D	
B.8232	South	PATIALA	11KV	DS S/U DIVN PATIALA	DS S/D Reektheri	B153FL00	11 KV JAGGO	NON AMR	OK	31.03.2023	AP 3Phase 3Wire				11117727	1200/577/1-1	2.223	NA	Director/D	
B.8233	South	PATIALA	11KV	DS S/U DIVN PATIALA	DS S/D Reektheri	B153FL02	11KV PANODIND	NON AMR	OK	31.03.2023	AP 3Phase 3Wire				8222725	1200/577/1-1	2.437	NA	Director/D	
B.8234	South	PATIALA	11KV	DS S/U DIVN PATIALA	DS S/D Reektheri	B153FL01	11 ANAR	NON AMR	OK	31.03.2023	AP 3Phase 3Wire				8222728	1200/577/1-1	2.476	NA	Director/D	
B.8235	South	PATIALA	11KV	DS S/U DIVN PATIALA	DS S/D Reektheri	B153FL10	11 KV UPS 2	AMR	OK	31.03.2023	Category 5-UPS				9154323	1200/577/1-1	7.724	NA	Director/D	
B.8236	South	PATIALA	11KV	DS S/U DIVN PATIALA	DS S/D Reektheri	D108FL04	11KV BEEHCHERI OLD	NON AMR	OK	31.03.2023	AP 3Phase 3Wire				8222919	1200-600/5	2.099	NA	Director/D	
B.8237	South	PATIALA	11KV	DS S/U DIVN PATIALA	DS S/D Reektheri	D108FL05	11KV NANDPUR KESHO	AMR	OK	31.03.2023	AP 3Phase 3Wire				123456	1200-600/5	2.167	NA	Director/D	
B.8238	South	PATIALA	11KV	DS S/U DIVN PATIALA	DS S/D Reektheri	D161FL14	Station Transformer Baran	AMR	OK	31.03.2023	Substation Transformer				2067014	Not installed	0.013	NA	Director/D	
B.8239	South	PATIALA	11KV	DS S/U DIVN PATIALA	DS S/D Reektheri	D161FL10	11 KV POWER GRID	AMR	OK	31.03.2023	Category 4				2066928	Not installed	0.177	NA	Director/D	
B.8240	South	PATIALA	11KV	DS S/U DIVN PATIALA	DS S/D Reektheri	D161FL13	Kohener vally	AMR	OK	31.03.2023	Category 1				3819	Not installed	0.425	NA	Director/D	
B.8241	South	PATIALA	11KV	DS S/U DIVN PATIALA	DS S/D Reektheri	D161FL12	TRICONE CITY	AMR	OK	31.03.2023	Category 5-UPS				3871	Not installed	0.883	NA	Director/D	
B.8242	South	PATIALA	11KV	DS S/U DIVN PATIALA	DS S/D Reektheri	D161FL15	11KV OMAKE CITY	AMR	OK	31.03.2023	Category 5-UPS				3884	Not installed	1.426	NA	Director/D	
B.8243	South	PATIALA	11KV	DS S/U DIVN PATIALA	DS S/D Reektheri	D161FL11	MIRZAPUR	AMR	OK	31.03.2023	AP 3Phase 3Wire				15196584	Not installed	1.763	NA	Director/D	
B.8244	South	PATIALA	11KV	DS S/U DIVN PATIALA	DS S/D Reektheri	D161F06	11KV DAULTAPUR	AMR	OK	31.03.2023	AP 3Phase 3Wire				8222932	Not installed	2.781	NA	Director/D	
B.8245	South	PATIALA	11KV	DS S/U DIVN PATIALA	DS S/D Reektheri	D161F01	11KV KALWA	AMR	OK	31.03.2023	AP 3Phase 3Wire				8222939	Not installed	2.962	NA	Director/D	
B.8246	South	PATIALA	11KV	DS S/U DIVN PATIALA	DS S/D Reektheri	D161F02	11KV REEKHERI NEW	AMR	OK	31.03.2023	AP 3Phase 3Wire				8222936	Not installed	3.195	NA	Director/D	
B.8247	South	PATIALA	11KV	DS S/U DIVN PATIALA	DS S/D Reektheri	D161F05	11KV CHALELA OLD	AMR	OK	31.03.2023	AP 3Phase 3Wire				8222936	Not installed	3.447	NA	Director/D	
B.8248	South	PATIALA	11KV	DS S/U DIVN PATIALA	DS S/D Reektheri	D161F08	11KV BARAN	AMR	OK	31.03.2023	Category 5-UPS				2067329	Not installed	5.748	NA	Director/D	
B.8249	South	PATIALA	11KV	DS S/U DIVN PATIALA	DS S/D Reektheri	D161F09	11KV UPS	AMR	OK	31.03.2023	Category 5-UPS				2066517	Not installed	11.648	NA	Director/D	
B.8250	South	PATIALA	11KV	DS S/U DIVN PATIALA	DS S/D Reektheri	D161F08	11 KV RASULPUR	AMR	OK	31.03.2023	AP 3Phase 3Wire				4018	900-450/577/1-1	1.862	NA	Director/D	
B.8251	South	PATIALA	11KV	DS S/U DIVN PATIALA	DS S/D Reektheri	D161F15	05A 2	AMR	OK	31.03.2023	Category 4				1266598	1200/577/1-1	6.736	NA	Director/D	
B.8252	South	PATIALA	11KV	DS S/U DIVN PATIALA	DS S/D Reektheri	D161F13	11KV G.S.A	AMR	OK	31.03.2023	Category 4				197913	900-450/577/1-1	14.434	NA	Director/D	
B.8253	South	PATIALA	11KV	DS S/U DIVN PATIALA	DS S/D Reektheri	D161F04	11 KV CHALELA NEW	AMR	OK	31.03.2023	AP 3Phase 3Wire				9544705	Not installed	2.140	NA	Director/D	
B.8254	South	PATIALA	11KV	DS S/U DIVN PATIALA	DS S/D Reektheri	D161F09	11KV FAGGANMAIRA	NON AMR	OK	31.03.2023	AP 3Phase 3Wire				9154335	900-450/577/1-1	2.382	NA	Director/D	
B.8255	South	PATIALA	11KV	DS S/U DIVN PATIALA	DS S/D Reektheri	D161F10	11KV CHALELA - 2	AMR	OK	31.03.2023	AP 3Phase 3Wire				9544705	900-450/577/1-1	2.694	NA	Director/D	
B.8256	South	PATIALA	11KV	DS S/U DIVN PATIALA	DS S/D Reektheri	D161F08	11KV KHALFALW	AMR	OK	31.03.2023	AP 3Phase 3Wire				9154441	Not installed	2.903	NA	Director/D	
B.8257	South	PATIALA	11KV	DS S/U DIVN PATIALA	DS S/D Reektheri	D161F12	PUNJANMAURA UPS	AMR	OK	31.03.2023	Category 5-UPS				1112297	Not installed	3.327	NA	Director/D	
B.8258	South	PATIALA	11KV	DS S/U DIVN PATIALA	DS S/D Urban Estate Patiala	D162FL01	PUNJABI UNIVERSITY	AMR	OK	31.03.2023	Category 4				2065728	Not installed	1.581	NA	Director/D	
B.8259	South	PATIALA	11KV	DS S/U DIVN PATIALA	DS S/D Urban Estate Patiala	D162FL13	Panchvati Feeder	AMR	OK	31.03.2023	Category 1				5936	Not installed	0.006	NA	Director/D	
B.8260	South	PATIALA	11KV	DS S/U DIVN PATIALA	DS S/D Urban Estate Patiala	D162FL03	ALL INDIA RADIO	AMR	OK	31.03.2023	Category 4				2067236	Not installed	0.414	NA	Director/D	
B.8261	South	PATIALA	11KV	DS S/U DIVN PATIALA	DS S/D Urban Estate Patiala	D162FL08	Rishi Colony Feeder	AMR	OK	31.03.2023	Category 1				6650	Not installed	2.061	NA	Director/D	
B.8262	South	PATIALA	11KV	DS S/U DIVN PATIALA	DS S/D Urban Estate Patiala	D162FL12	DS NORTH Phase-4	AMR	OK	31.03.2023	Category 1				32006	1200-600/5	3.676	NA	Director/D	
B.8263	South	PATIALA	11KV	DS S/U DIVN PATIALA	DS S/D Urban Estate Patiala	D162FL04	PUNJABI UNIVERSITY	AMR	OK	31.03.2023	Category 1				5795551	Not installed	6.073	NA	Director/D	
B.8264	South	PATIALA	11KV	DS S/U DIVN PATIALA	DS S/D Urban Estate Patiala	D162FL15	DEELWAL	AMR	OK	31.03.2023	Category 1				36743	1200-600/5	6.090	NA	Director/D	
B.8265	South	PATIALA	11KV	DS S/U DIVN PATIALA	DS S/D Urban Estate Patiala	D162FL02	SALARA VIHAR	AMR	OK	31.03.2023	Category 1				6745294	Not installed	6.597	NA	Director/D	
B.8266	South	PATIALA	11KV	DS S/U DIVN PATIALA	DS S/D Urban Estate Patiala	D162FL14	FRENDS COLONY	AMR	OK	31.03.2023	Category 1				36655	1200-600/5	7.564	NA	Director/D	
B.8267	South	PATIALA	11KV	DS S/U DIVN PATIALA	DS S/D Urban Estate Patiala	D162FL10	PROFESSOR COLONY	AMR	OK	31.03.2023	Category 1				36976	1200-600/5	7.952	NA	Director/D	
B.8268	South	PATIALA	11KV	DS S/U DIVN PATIALA	DS S/D Urban Estate Patiala	D162FL07	INDIA RADIO	AMR	OK	31.03.2023	Category 1				1112297	Not installed	8.079	NA	Director/D	
B.8269	South	PATIALA	11KV	DS S/U DIVN PATIALA	DS S/D Urban Estate Patiala	D162FL05	BANK FEEDER	AMR	OK	31.03.2023	Category 1				15193887	Not installed	8.567	NA	Director/D	
B.8270	South	PATIALA	11KV	DS S/U DIVN PATIALA	DS S/D Urban Estate Patiala	D162FL06	MEHTA COLONY	AMR	OK	31.03.2023	Category 1				11116985	Not installed	9.102	NA	Director/D	
B.8271	South	PATIALA	11KV	DS S/U DIVN PATIALA	DS S/D Urban Estate Patiala	D162FL01	URBAN ESTATE	AMR	OK	31.03.2023	Category 1				34239	1200-600/5	9.678	NA	Director/D	
B.8272	South	PATIALA	11KV	DS WEST DIVN PATIALA	DS NORTH TECH S/D PTA	B151tem1	11 kv vikas nagar	AMR	OK	31.03.2023	Category 1				9154428	Not installed	4.994	NA	Director/D	
B.8273	South	PATIALA	11KV	DS WEST DIVN PATIALA	DS NORTH TECH S/D PTA	B151FL13	DS NORTH TECH S/D PTA	AMR	OK	31.03.2023	Category 1				102103131	Not installed	8.866	NA	Director/D	
B.8274	South	PATIALA	11KV	DS WEST DIVN PATIALA	DS NORTH TECH S/D PTA	B151FL05	Dashmesh Nagar	AMR	OK	31.03.2023	Category 1				5259599	Not installed	11.528	NA	Director/D	
B.8275	South	PATIALA	11KV	DS WEST DIVN PATIALA	DS NORTH TECH S/D PTA	B151E14	ANAND NAGAR	AMR	OK	31.03.2023	Category 1				9154285	Not installed	12.384	NA	Director/D	
B.8276	South	PATIALA	11KV	DS WEST DIVN PATIALA	DS NORTH TECH S/D PTA	K152FL11	Eka Vihar	AMR	OK	31.03.2023	Category 1				3406	Not installed	2.393	NA	Director/D	
B.8277	South	PATIALA	11KV	DS WEST DIVN PATIALA	DS NORTH TECH S/D PTA	D151FL11	Sirhind Road	AMR	OK	31.03.2023	Category 1				2067244	Not installed	10.863	NA	Director/D	
B.8278	South	PATIALA	11KV	DS WEST DIVN PATIALA	DS NORTH TECH S/D PTA	D151FL13	Factory Arealok	AMR	OK	31.03.2023	Category 1				16194349	Not installed	12.375	NA	Director/D	
B.8279	South	PATIALA	11KV	DS WEST DIVN PATIALA	DS NORTH TECH S/D PTA	D161FL07	Industrial Estate(eold)	AMR	OK	31.03.2023	Category 1				2068820	Not installed	9.632	NA	Director/D	
B.8280	South	PATIALA	11KV	DS WEST DIVN PATIALA	DS NORTH TECH S/D PTA	D161FL03	Alpur	AMR	OK	31.03.2023	Category 1				3126	Not installed	13.961	NA	Director/D	
B.8281	South	PATIALA	11KV	DS WEST DIVN PATIALA	DS NORTH TECH S/D PTA	D161FL04	Jhuli	AMR	OK	31.03.2023	Category 1				3100	Not installed	14.274	NA	Director/D	
B.8282	South	PATIALA	11KV	DS WEST DIVN PATIALA	DS NORTH TECH S/D PTA	D161FL05	11 KV Bhawani Polymers Focal P	AMR	OK											

S.No	Zone	Circle	Voltage Level (kVA)	Division (kVA)	Sub-Division (kVA)	Feeder ID	Feeder Name	Feeder Metering Status (Metered/unmetered/AMR/AMI)	Status of Meter (Functional/Non-functional)	Metering Date	% data received through automatically by feeder AMR/AMI	Status of Communication		Period from 01.04.2021 to 31.03.2022		Sales	Remarks (Source of data)	
												Total Number of hours in the period	Number of hours when meter was unable to communicate in overall	Meter S.No	CT/PT ratio			Import (kWh)
B.8312	South	PATIALA	11KV	DS WEST DIVN PATIALA	DS WEST TECH S/D PTA	D515FL06	Gurbaa Colony	AMR	OK	31.03.2023	Category 1			5341565	Not installed	8.958	NA	Director/D
B.8313	South	PATIALA	11KV	DS WEST DIVN PATIALA	DS WEST TECH S/D PTA	D515FL01	Lower Mall	AMR	OK	31.03.2023	Category 1			4186063	Not installed	10.690	NA	Director/D
B.8314	South	PATIALA	11KV	DS WEST DIVN PATIALA	DS WEST TECH S/D PTA	D515FL20	VHK Colony	AMR	OK	31.03.2023	Category 1			16199425	900-450/577/1-1-1	10.761	NA	Director/D
B.8315	South	PATIALA	11KV	DS WEST DIVN PATIALA	DS WEST TECH S/D PTA	D515FL14	Newly Park	AMR	OK	31.03.2023	Category 1			20617361	Not installed	15.993	NA	Director/D
B.8316	South	PATIALA	11KV	DS WEST DIVN PATIALA	DS WEST TECH S/D PTA	D515FL06	Paig Ground	AMR	OK	31.03.2023	Category 1			2065679	1200/577/1-1-1	9.604	NA	Director/D
B.8317	South	PATIALA	11KV	DS WEST DIVN PATIALA	DS WEST TECH S/D PTA	D515FL16	CHOTTI BARADARI	AMR	OK	31.03.2023	Category 1			16199455	Not installed	0.000	NA	Director/D
B.8318	South	PATIALA	11KV	DS WEST DIVN PATIALA	DS WEST TECH S/D PTA	D515FL07	Hira Nagar	AMR	OK	31.03.2023	Category 1			4450	Not installed	7.592	NA	Director/D
B.8319	South	PATIALA	11KV	DS WEST DIVN PATIALA	DS WEST TECH S/D PTA	D515FL10	Leela Bhandan	AMR	OK	31.03.2023	Category 1			6745304	Not installed	12.653	NA	Director/D
B.8320	South	PATIALA	11KV	DS WEST DIVN PATIALA	DS WEST TECH S/D PTA	D519FL09	11kv GORND BAGH	AMR	OK	31.03.2023	Category 1			36957	1200-600/5	9.756	NA	Director/D
B.8321	South	ROPAR	11KV	DS DIVN. KHARAR	DS S/D CITY KHARAR	C252FL28	Chandigarh Road	AMR	OK	31.03.2023	Category 1			123456	Not installed	3.007	NA	Director/D
B.8322	South	ROPAR	11KV	DS DIVN. KHARAR	DS S/D CITY KHARAR	C252FL18	MODEL TOWN	AMR	OK	31.03.2023	Category 1			7336420	Not installed	4.460	NA	Director/D
B.8323	South	ROPAR	11KV	DS DIVN. KHARAR	DS S/D CITY KHARAR	C252FL09	KTM	AMR	OK	31.03.2023	Category 1			5437745	Not installed	5.971	NA	Director/D
B.8324	South	ROPAR	11KV	DS DIVN. KHARAR	DS S/D CITY KHARAR	C252FL31	Dashmesh Nagar	AMR	OK	31.03.2023	Category 1			222879	Not installed	15.644	NA	Director/D
B.8325	South	ROPAR	11KV	DS DIVN. KHARAR	DS S/D CITY KHARAR	C252FL08	MUNDI KHARAR	AMR	OK	31.03.2023	Category 1			6485756	Not installed	16.323	NA	Director/D
B.8326	South	ROPAR	11KV	DS DIVN. KHARAR	DS S/D CITY KHARAR	C252FL17	SHIVGT	AMR	OK	31.03.2023	Category 1			9534573	Not installed	18.698	NA	Director/D
B.8327	South	ROPAR	11KV	DS DIVN. KHARAR	DS S/D CITY KHARAR	0274FL25	11KV Gillo Velly	AMR	OK	31.03.2023	Category 1			73132187	400-200/5-5	11.643	NA	Director/D
B.8328	South	ROPAR	11KV	DS DIVN. KHARAR	DS S/D CITY KHARAR	0274FL26	11KV Shivalk Heights	AMR	OK	31.03.2023	Category 1			73132196	400-200/5-5	12.439	NA	Director/D
B.8329	South	ROPAR	11KV	DS DIVN. KHARAR	DS S/D CITY KHARAR	0252FL12	11 KV Sunny Mandir	AMR	OK	31.03.2023	Category 1			1234	1200-600/5	4.296	NA	Director/D
B.8330	South	ROPAR	11KV	DS DIVN. KHARAR	DS S/D CITY KHARAR	0252FL13	11 KV Chajumajra	NON AMR	OK	31.03.2023	Category 1			12345	1200-600/5	8.660	NA	Director/D
B.8331	South	ROPAR	11KV	DS DIVN. KHARAR	DS S/D CITY KHARAR	0252FL09	Nijjar Road	NON AMR	OK	31.03.2023	Category 1			123456	1200-600/5	8.927	NA	Director/D
B.8332	South	ROPAR	11KV	DS DIVN. KHARAR	DS S/D CITY KHARAR	0252FL01	11 KV Old Sunny	AMR	OK	31.03.2023	Category 1			15199027	1200/577/1-1-1	10.613	NA	Director/D
B.8333	South	ROPAR	11KV	DS DIVN. KHARAR	DS S/D CITY KHARAR	0252FL06	PARADISE	Not available	OK	31.03.2023	Category 1			197921	1200/577/1-1-1	13.551	NA	Director/D
B.8334	South	ROPAR	66KV	DS DIVN. KHARAR	DS S/D CITY KHARAR	8301DL14	PTL CHAPPAR CHIRRI	AMR	OK	31.03.2023	Category 4			Not available	Not available	15.241	NA	Director/D
B.8335	South	ROPAR	11KV	DS DIVN. KHARAR	DS S/D CITY MORINDA	0252FL15	SANGATPURA	AMR	OK	31.03.2023	AP 3Phase 3Wire			2066807	900-450/577/1-1-1	1.226	NA	Director/D
B.8336	South	ROPAR	11KV	DS DIVN. KHARAR	DS S/D CITY MORINDA	0252FL13	PANJKOHA NO.1	AMR	OK	31.03.2023	AP 3Phase 3Wire			8227203	1200/577/1-1-1	1.761	NA	Director/D
B.8337	South	ROPAR	11KV	DS DIVN. KHARAR	DS S/D CITY MORINDA	0252FL06	DOOMCHANDRI	AMR	OK	31.03.2023	AP 3Phase 3Wire			8223540	900-450/577/1-1-1	1.861	NA	Director/D
B.8338	South	ROPAR	11KV	DS DIVN. KHARAR	DS S/D CITY MORINDA	0252FL14	CHALAKI	AMR	OK	31.03.2023	AP 3Phase 3Wire			2066971	1200/577/1-1-1	2.113	NA	Director/D
B.8339	South	ROPAR	11KV	DS DIVN. KHARAR	DS S/D CITY MORINDA	0252FL11	ROUNI	AMR	OK	31.03.2023	AP 3Phase 3Wire			9154338	1200/577/1-1-1	2.292	NA	Director/D
B.8340	South	ROPAR	11KV	DS DIVN. KHARAR	DS S/D CITY MORINDA	0252FL07	PANJKOHA 2	AMR	OK	31.03.2023	AP 3Phase 3Wire			8223538	900-450/577/1-1-1	2.704	NA	Director/D
B.8341	South	ROPAR	11KV	DS DIVN. KHARAR	DS S/D CITY MORINDA	0252FL09	BOOTHGARGH	AMR	OK	31.03.2023	Category 5-UPS			4221026	900-450/577/1-1-1	6.367	NA	Director/D
B.8342	South	ROPAR	11KV	DS DIVN. KHARAR	DS S/D CITY MORINDA	0252FL22	11KV Siddipur	AMR	OK	31.03.2023	Category 5-UPS			36876	1200/577/1-1-1	8.198	NA	Director/D
B.8343	South	ROPAR	11KV	DS DIVN. KHARAR	DS S/D CITY MORINDA	0252FL04	EMADA Water Works	AMR	OK	31.03.2023	Category 4			9354004	1200/577/1-1-1	11.123	NA	Director/D
B.8344	South	ROPAR	11KV	DS DIVN. KHARAR	DS S/D CITY MORINDA	0252FL02	BADWALI	AMR	OK	31.03.2023	AP 3Phase 3Wire			9141089	900-450/577/1-1-1	2.948	NA	Director/D
B.8345	South	ROPAR	11KV	DS DIVN. KHARAR	DS S/D CITY MORINDA	0252FL01	SUGARMILLI	AMR	OK	31.03.2023	Category 4			7336701	900-450/577/1-1-1	5.836	NA	Director/D
B.8346	South	ROPAR	11KV	DS DIVN. KHARAR	DS S/D CITY MORINDA	0252FL15	DARPAN	AMR	OK	31.03.2023	Category 1			12527387	900-450/577/1-1-1	8.864	NA	Director/D
B.8347	South	ROPAR	11KV	DS DIVN. KHARAR	DS S/D CITY MORINDA	0252FL13	11 KV SHSH GANI	AMR	OK	31.03.2023	Category 1			3155	1200-600/5	10.299	NA	Director/D
B.8348	South	ROPAR	11KV	DS DIVN. KHARAR	DS S/D CITY MORINDA	0252FL09	CTTY	Not available	OK	31.03.2023	Category 1			Not available	1200-600/5	16.115	NA	Director/D
B.8349	South	ROPAR	66KV	DS DIVN. KHARAR	DS S/D CITY MORINDA	0252FL17	Kajali Water works-2	Not available	OK	31.03.2023	Category 1			Not available	Not available	0.092	NA	Director/D
B.8350	South	ROPAR	66KV	DS DIVN. KHARAR	DS S/D CITY MORINDA	0252FL16	KAJALI WATER WORKS 1	AMR	OK	31.03.2023	Category 2			Not available	Not available	41.082	NA	Director/D
B.8351	South	ROPAR	11KV	DS DIVN. KHARAR	DS S/D CITY-2 KHARAR	C252FL36	11kv Station T/F-1	AMR	OK	31.03.2023	Category 1			8222840	Not installed	0.061	NA	Director/D
B.8352	South	ROPAR	11KV	DS DIVN. KHARAR	DS S/D CITY-2 KHARAR	C252FL38	11kv Station T/F-2	AMR	OK	31.03.2023	Category 1			23248	Not installed	0.076	NA	Director/D
B.8353	South	ROPAR	11KV	DS DIVN. KHARAR	DS S/D CITY-2 KHARAR	C252FL13	Banglag	AMR	OK	31.03.2023	Category 5-UPS			7338441	Not installed	0.207	NA	Director/D
B.8354	South	ROPAR	11KV	DS DIVN. KHARAR	DS S/D CITY-2 KHARAR	C252FL05	SANTE MAJRA	AMR	OK	31.03.2023	AP 3Phase 3Wire			8223880	Not installed	10.845	NA	Director/D
B.8355	South	ROPAR	11KV	DS DIVN. KHARAR	DS S/D CITY-2 KHARAR	C252FL30	Ambika Devi	AMR	OK	31.03.2023	Category 1			6745302	Not installed	2.239	NA	Director/D
B.8356	South	ROPAR	11KV	DS DIVN. KHARAR	DS S/D CITY-2 KHARAR	C252FL35	11KV Rasanheri	AMR	OK	31.03.2023	AP 3Phase 3Wire			8222840	Not installed	2.414	NA	Director/D
B.8357	South	ROPAR	11KV	DS DIVN. KHARAR	DS S/D CITY-2 KHARAR	C252FL10	BADALI	AMR	OK	31.03.2023	AP 3Phase 4Wire			8222840	Not installed	2.753	NA	Director/D
B.8358	South	ROPAR	11KV	DS DIVN. KHARAR	DS S/D CITY-2 KHARAR	G252FL16	HOSPITAL	AMR	OK	31.03.2023	Category 3			8222838	Not installed	3.832	NA	Director/D
B.8359	South	ROPAR	11KV	DS DIVN. KHARAR	DS S/D CITY-2 KHARAR	C252FL12	KANJ MANDI	AMR	OK	31.03.2023	Category 1			7338276	Not installed	6.556	NA	Director/D
B.8360	South	ROPAR	11KV	DS DIVN. KHARAR	DS S/D CITY-2 KHARAR	C252FL15	KHANPUR	AMR	OK	31.03.2023	Category 1			8222879	Not installed	11.300	NA	Director/D
B.8361	South	ROPAR	11KV	DS DIVN. KHARAR	DS S/D CITY-2 KHARAR	C252FL04	CTY KHARAR	AMR	OK	31.03.2023	Category 1			6745302	Not installed	14.291	NA	Director/D
B.8362	South	ROPAR	11KV	DS DIVN. KHARAR	DS S/D CITY-2 KHARAR	C252FL24	Ranjit Nagar	NON AMR	OK	31.03.2023	Category 1			953548	Not installed	18.806	NA	Director/D
B.8363	South	ROPAR	11KV	DS DIVN. KHARAR	DS S/D CITY-2 KHARAR	0276FL03	AWHO-2	AMR	OK	31.03.2023	Category 1			123456	1200/577/1-1-1	0.000	NA	Director/D
B.8364	South	ROPAR	11KV	DS DIVN. KHARAR	DS S/D CITY-2 KHARAR	0276FL02	Ansal-2	AMR	OK	31.03.2023	Category 1			1519644	1200/577/1-1-1	1.136	NA	Director/D
B.8365	South	ROPAR	11KV	DS DIVN. KHARAR	DS S/D CITY-2 KHARAR	0276FL01	Ansal-1	AMR	OK	31.03.2023	Category 1			1519651	1200/577/1-1-1	1.972	NA	Director/D
B.8366	South	ROPAR	11KV	DS DIVN. KHARAR	DS S/D CITY-2 KHARAR	0276FL39	11 KV Santemaria	NON AMR	OK	31.03.2023	AP 3Phase 3Wire			123456	1200/577/1-1-1	2.144	NA	Director/D
B.8367	South	ROPAR	11KV	DS DIVN. KHARAR	DS S/D CITY-2 KHARAR	0276FL05	AHWO-1	AMR	OK	31.03.2023	Category 1			123456	1200/577/1-1-1	3.258	NA	Director/D
B.8368	South	ROPAR	11KV	DS DIVN. KHARAR	DS S/D CITY-2 KHARAR	0276FL04	Orchard County	AMR	OK	31.03.2023	Category 1			15196142	1200/577/1-1-1	14.203	NA	Director/D
B.8369	South	ROPAR	11KV	DS DIVN. KHARAR	DS S/D CITY-2 KHARAR	0276FL40	11 KV Casa Homes	AMR	OK	31.03.2023	Category 1			1234	1200/577/1-1-1	15.469	NA	Director/D
B.8370	South	ROPAR	11KV	DS DIVN. KHARAR	DS S/D CITY-2 KHARAR	0276FL41	11 KV Sector 1115	AMR	OK	31.03.2023	Category 1			1234	400-200/5-5	0.815	NA	Director/D
B.8371	South	ROPAR	11KV	DS DIVN. KHARAR	DS S/D CITY-2 KHARAR	DS25FL22	SOM DUTT	NON AMR	OK	31.03.2023	Category 1			73132194	400-200/5-5	0.952	NA	Director/D
B.8372	South	ROPAR	11KV	DS DIVN. KHARAR	DS S/D CITY-2 KHARAR	0274FL05	11KV JPTL	NON AMR	OK	31.03.2023	Category 1			1234	1200-600/5	7.216	NA	Director/D
B.8373	South	ROPAR	11KV	DS DIVN. KHARAR	DS S/D CITY-2 KHARAR	0274FL19	ACME HEIGHT	NON AMR	OK	31.03.2023	Category 1			1234	1200-600/5	10.464	NA	Director/D
B.8374	South	ROPAR	11KV	DS DIVN. KHARAR	DS S/D CITY-2 KHARAR	0276FL06	11KV GCG JHANIHERI	NON AMR	OK	31.03.2023	Category 5-UPS			33407	400-200/5-5	11.115	NA	Director/D
B.8375	South	ROPAR	11KV	DS DIVN. KHARAR	DS S/D CITY-2 KHARAR	0274FL20	11 KV Badala Road	AMR	OK	31.03.2023	Category 1			12345	400-200/5-5	18.349	NA	Director/D
B.8376	South	ROPAR	11KV	DS DIVN. KHARAR	DS S/D KURALI	0262FL13	KOR	AMR	OK	31.03.2023	AP 3Phase 3Wire			123456	Not installed	1.534	NA	Director/D
B.8377	South	ROPAR	11KV	DS DIVN. KHARAR	DS S/D KURALI	0262FL05	BOOR MAJRA (URBAN)	AMR	OK	31.03.2023	Category 1			2067619	Not installed	1.745	NA	Director/D
B.8378	South	ROPAR	11KV	DS DIVN. KHARAR	DS S/D KURALI	0262FL04	DHANAURI FEEDER	AMR	OK	31.03.2023	AP 3Phase 3Wire			2067972	Not installed	2.546	NA	Director/D
B.8379	South	ROPAR	11KV	DS DIVN. KHARAR	DS S/D KURALI	0262FL03	BOOR MAJRA (R)	AMR	OK	31.03.2023	Category 1			9534346	Not installed	2.671	NA	Director/D
B.8380	South	ROPAR	11KV	DS DIVN. KHARAR	DS S/D KURALI	0262FL09	KARALI	AMR	OK	31.03.2023	Category 5-UPS			10277316				

S.No	Zone	Circle	Voltage Level (kVA)	Division (kVA)	Sub-Division (kVA)	Feeder ID	Feeder Name	Feeder Metering Status (Metered/unmetered/AMR/AMI)	Status of Meter (Functional/Non-Functional)	Metering Date (Date of last actual meter reading/communication)	Feeder Type (Agr/Industrial/Mixed)	Status of Communication			Period from 01.04.2021 to 31.03.2022				Sales	Remarks (Source of data)
												% Data received through automatically if feeder AMR/AMI	Number of hours when meter was unable to communicate in week	Total Number of hours in the period	Meter S.No	CT/PT ratio	Import (kWh)	Export (kWh)		
B.8409	South	ROPAR	11KV	DS DIVN. KHARAR	DS S/D MAIRA	0253FL16	22K KV S/5 Majra	AMR	OK	31.03.2023	Category 4				198039	900-450/577/1-1-1	0.076	NA	Director/D	
B.8410	South	ROPAR	11KV	DS DIVN. KHARAR	DS S/D MAIRA	0253FL19	11 KV Station Transformer	AMR	OK	31.03.2023	Category 4				4744	900-450/577/1-1-1	0.113	NA	Director/D	
B.8411	South	ROPAR	11KV	DS DIVN. KHARAR	DS S/D MAIRA	0253FL21	ECO CITY 2	AMR	OK	31.03.2023	Category 1				27704	1200/577/1-1-1	0.821	NA	Director/D	
B.8412	South	ROPAR	11KV	DS DIVN. KHARAR	DS S/D MAIRA	0253FL06	METRO FEEDER	AMR	OK	31.03.2023	Category 4				2063430	1200/577/1-1-1	0.901	NA	Director/D	
B.8413	South	ROPAR	11KV	DS DIVN. KHARAR	DS S/D MAIRA	0253FL01	RANA MAHINDRA PAPER MILL	AMR	OK	31.03.2023	Category 4				5437723	900-450/577/1-1-1	1.085	NA	Director/D	
B.8414	South	ROPAR	11KV	DS DIVN. KHARAR	DS S/D MAIRA	0253FL13	METRO ECO GREEN RESORT	AMR	OK	31.03.2023	Category 4				23704	1200/577/1-1-1	3.361	NA	Director/D	
B.8415	South	ROPAR	11KV	DS DIVN. KHARAR	DS S/D MAIRA	0253FL11	SISWAN	AMR	OK	31.03.2023	Kandi Mixed				7042976	900-450/577/1-1-1	3.856	NA	Director/D	
B.8416	South	ROPAR	11KV	DS DIVN. KHARAR	DS S/D MAIRA	0253FL08	KANSALA FEEDER	AMR	OK	31.03.2023	Kandi Mixed				2067207	1200/577/1-1-1	4.906	NA	Director/D	
B.8417	South	ROPAR	11KV	DS DIVN. KHARAR	DS S/D MAIRA	0253FL07	SALBA FEEDER	AMR	OK	31.03.2023	Kandi Mixed				11116949	900-450/577/1-1-1	5.401	NA	Director/D	
B.8418	South	ROPAR	11KV	DS DIVN. KHARAR	DS S/D MAIRA	0253FL03	DHAKORAN FEEDER	AMR	OK	31.03.2023	Kandi Mixed				2065409	900-450/577/1-1-1	6.074	NA	Director/D	
B.8419	South	ROPAR	11KV	DS DIVN. KHARAR	DS S/D MAIRA	0253FL02	KHURABAD FEEDER	AMR	OK	31.03.2023	Kandi Mixed				10281183	1200/577/1-1-1	7.513	NA	Director/D	
B.8420	South	ROPAR	11KV	DS DIVN. KHARAR	DS S/D MAIRA	0253FL22	11 KV Chandpur	AMR	OK	31.03.2023	Kandi Mixed				5225	1200/577/1-1-1	7.604	NA	Director/D	
B.8421	South	ROPAR	11KV	DS DIVN. KHARAR	DS S/D MAIRA	0253FL05	PTI FEEDER	AMR	OK	31.03.2023	Kandi Mixed				2066335	900-450/577/1-1-1	8.068	NA	Director/D	
B.8422	South	ROPAR	11KV	DS DIVN. KHARAR	DS S/D MAIRA	0253FL10	BARONI FEEDER	AMR	OK	31.03.2023	Kandi Mixed				5295707	1200/577/1-1-1	8.704	NA	Director/D	
B.8423	South	ROPAR	11KV	DS DIVN. KHARAR	DS S/D MAIRA	0253FL09	RANGUANA FEEDER	Not available	OK	31.03.2023	Kandi Mixed				4219650	900-450/577/1-1-1	9.409	NA	Director/D	
B.8424	South	ROPAR	66KV	DS DIVN. KHARAR	DS S/D MAIRA	C252D008	MBM	AMR	OK	31.03.2023	Category 4				Not available	Not available	49.121	NA	Director/D	
B.8425	South	ROPAR	11KV	DS DIVN. KHARAR	DS S/U S/D KHARAR	C252FL25	CHANDO	AMR	OK	31.03.2023	Kandi Mixed				2066591	Not installed	0.962	NA	Director/D	
B.8426	South	ROPAR	11KV	DS DIVN. KHARAR	DS S/U S/D KHARAR	C252FL03	GHURLIAN	AMR	OK	31.03.2023	AP 3Phase 3Wire				2877016	Not installed	1.277	NA	Director/D	
B.8427	South	ROPAR	11KV	DS DIVN. KHARAR	DS S/U S/D KHARAR	C252FL01	GRANGA	AMR	OK	31.03.2023	AP 3Phase 3Wire				8222839	Not installed	3.941	NA	Director/D	
B.8428	South	ROPAR	11KV	DS DIVN. KHARAR	DS S/U S/D KHARAR	C252FL06	MAJHPUR	AMR	OK	31.03.2023	AP 3Phase 3Wire				8222878	Not installed	4.293	NA	Director/D	
B.8429	South	ROPAR	11KV	DS DIVN. KHARAR	DS S/U S/D KHARAR	C252FL07	Sehauran	AMR	OK	31.03.2023	Kandi Mixed				223787	Not installed	6.786	NA	Director/D	
B.8430	South	ROPAR	11KV	DS DIVN. KHARAR	DS S/U S/D KHARAR	C252FL29	UPS BHAGOMAURA	AMR	OK	31.03.2023	Category 5-UPS				9153548	Not installed	8.793	NA	Director/D	
B.8431	South	ROPAR	11KV	DS DIVN. KHARAR	DS S/U S/D KHARAR	C252FL11	RADIALA	AMR	OK	31.03.2023	Category 5-UPS				11069772	Not installed	9.782	NA	Director/D	
B.8432	South	ROPAR	11KV	DS DIVN. KHARAR	DS S/U S/D KHARAR	C252FL14	RORA	AMR	OK	31.03.2023	Category 5-UPS				2046491	Not installed	12.277	NA	Director/D	
B.8433	South	ROPAR	11KV	DS DIVN. KHARAR	DS S/U S/D KHARAR	0275FL08	11 KV Roorki	AMR	OK	31.03.2023	Category 5-UPS				5227	1200/577/1-1-1	0.465	NA	Director/D	
B.8434	South	ROPAR	11KV	DS DIVN. KHARAR	DS S/U S/D KHARAR	0275FL06	11 KV Teer. UPS	NON AMR	OK	31.03.2023	Category 5-UPS				4891	1200/577/1-1-1	2.136	NA	Director/D	
B.8435	South	ROPAR	11KV	DS DIVN. KHARAR	DS S/U S/D KHARAR	0275FL01	SUHAL	NON AMR	OK	31.03.2023	Kandi Mixed				16194334	1200/577/1-1-1	3.882	NA	Director/D	
B.8436	South	ROPAR	11KV	DS DIVN. KHARAR	DS S/U S/D KHARAR	0275FL02	BHAJOJI	NON AMR	OK	31.03.2023	Kandi Mixed				16194329	1200/577/1-1-1	5.152	NA	Director/D	
B.8437	South	ROPAR	11KV	DS DIVN. KHARAR	DS S/U S/D KHARAR	0275FL03	LAHNAUR	NON AMR	OK	31.03.2023	Kandi Mixed				22018067	1200/577/1-1-1	5.484	NA	Director/D	
B.8438	South	ROPAR	11KV	DS DIVN. KHARAR	DS S/U S/D KHARAR	0275FL05	11 KV Allahpur	NON AMR	OK	31.03.2023	Category 5-UPS				4890	1200/577/1-1-1	6.502	NA	Director/D	
B.8439	South	ROPAR	11KV	DS DIVN. KHARAR	DS S/U S/D KHARAR	0275FL04	PALHERI	AMR	OK	31.03.2023	Kandi Mixed				198067	1200/577/1-1-1	7.867	NA	Director/D	
B.8440	South	ROPAR	11KV	DS DIVN. KHARAR	DS S/U S/D KHARAR	0265FL02	BASSIAN	AMR	OK	31.03.2023	AP 3Phase 3Wire				2065825	Not installed	2.621	NA	Director/D	
B.8441	South	ROPAR	11KV	DS DIVN. KHARAR	DS S/U S/D KHARAR	0265FL06	SOTAL	AMR	OK	31.03.2023	AP 3Phase 3Wire				6761903	900-450/577/1-1-1	3.393	NA	Director/D	
B.8442	South	ROPAR	11KV	DS DIVN. KHARAR	DS S/U S/D MORINDA	0262FL10	FATEHPUR	AMR	OK	31.03.2023	AP 3Phase 3Wire				8223445	Not installed	2.318	NA	Director/D	
B.8443	South	ROPAR	11KV	DS DIVN. KHARAR	DS S/U S/D MORINDA	0262FL01	RASULPUR	AMR	OK	31.03.2023	AP 3Phase 3Wire				2066647	Not installed	2.367	NA	Director/D	
B.8444	South	ROPAR	11KV	DS DIVN. KHARAR	DS S/U S/D MORINDA	0265FL08	SANKARPUR	AMR	OK	31.03.2023	AP 3Phase 3Wire				2066178	900-450/577/1-1-1	2.730	NA	Director/D	
B.8445	South	ROPAR	11KV	DS DIVN. KHARAR	DS S/U S/D MORINDA	0265FL01	CLAKS	AMR	OK	31.03.2023	Category 2				2065379	900-450/577/1-1-1	3.946	NA	Director/D	
B.8446	South	ROPAR	11KV	DS DIVN. KHARAR	DS S/U S/D MORINDA	0265FL07	lulon	AMR	OK	31.03.2023	AP 3Phase 3Wire				6760741	Not installed	3.482	NA	Director/D	
B.8447	South	ROPAR	11KV	DS DIVN. KHARAR	DS S/U S/D MORINDA	0252FL21	KALARAN	AMR	OK	31.03.2023	AP 3Phase 3Wire				2047126	1200/577/1-1-1	1.190	NA	Director/D	
B.8448	South	ROPAR	11KV	DS DIVN. KHARAR	DS S/U S/D MORINDA	0252FL08	CHAKALAN 2	AMR	OK	31.03.2023	AP 3Phase 3Wire				2067839	1200/577/1-1-1	1.730	NA	Director/D	
B.8449	South	ROPAR	11KV	DS DIVN. KHARAR	DS S/U S/D MORINDA	0252FL12	CHAKALAN 1	AMR	OK	31.03.2023	AP 3Phase 3Wire				9154404	1200/577/1-1-1	2.186	NA	Director/D	
B.8450	South	ROPAR	11KV	DS DIVN. KHARAR	DS S/U S/D MORINDA	0252FL20	11 KV Savi Industry	AMR	OK	31.03.2023	Category 2				2067106	900-450/577/1-1-1	0.085	NA	Director/D	
B.8451	South	ROPAR	11KV	DS DIVN. KHARAR	DS S/U S/D MORINDA	0252FL05	PATANGARH	AMR	OK	31.03.2023	AP 3Phase 3Wire				2067106	900-450/577/1-1-1	2.001	NA	Director/D	
B.8452	South	ROPAR	11KV	DS DIVN. KHARAR	DS S/U S/D MORINDA	0251FL11	BHATERI	AMR	OK	31.03.2023	AP 3Phase 3Wire				9141088	900-450/577/1-1-1	2.114	NA	Director/D	
B.8453	South	ROPAR	11KV	DS DIVN. KHARAR	DS S/U S/D MORINDA	0251FL08	DUMNA	AMR	OK	31.03.2023	AP 3Phase 3Wire				8223173	900-450/577/1-1-1	2.425	NA	Director/D	
B.8454	South	ROPAR	11KV	DS DIVN. KHARAR	DS S/U S/D MORINDA	0251FL03	MAROLIJI	AMR	OK	31.03.2023	AP 3Phase 3Wire				6745316	900-450/577/1-1-1	2.548	NA	Director/D	
B.8455	South	ROPAR	11KV	DS DIVN. KHARAR	DS S/U S/D MORINDA	0251FL14	11KV Budnada	AMR	OK	31.03.2023	AP 3Phase 3Wire				9141089	900-450/577/1-1-1	2.835	NA	Director/D	
B.8456	South	ROPAR	11KV	DS DIVN. KHARAR	DS S/U S/D MORINDA	0251FL10	CHARLAN	AMR	OK	31.03.2023	AP 3Phase 3Wire				3061455	400-200/5-5	3.061	NA	Director/D	
B.8457	South	ROPAR	11KV	DS DIVN. KHARAR	DS S/U S/D MORINDA	0251FL07	CHATAMALLA	AMR	OK	31.03.2023	AP 3Phase 3Wire				2068147	900-450/577/1-1-1	3.135	NA	Director/D	
B.8458	South	ROPAR	11KV	DS DIVN. KHARAR	DS S/U S/D MORINDA	0251FL04	GOLAPUR	AMR	OK	31.03.2023	AP 3Phase 3Wire				8222836	900-450/577/1-1-1	3.231	NA	Director/D	
B.8459	South	ROPAR	11KV	DS DIVN. KHARAR	DS S/U S/D MORINDA	0251FL06	RANGANJ	NON AMR	OK	31.03.2023	Category 5-UPS				6745316	900-450/577/1-1-1	4.546	NA	Director/D	
B.8460	South	ROPAR	11KV	DS DIVN. KHARAR	DS S/U S/D MORINDA	0251FL16	DATARPUR	AMR	OK	31.03.2023	Category 5-UPS				1422	900-450/577/1-1-1	12.359	NA	Director/D	
B.8461	South	ROPAR	11KV	DS DIVN. KHARAR	DS S/U S/D MORINDA	0251FL12	AMR	OK	31.03.2023	Category 5-UPS				23414	900-450/577/1-1-1	12.928	NA	Director/D		
B.8462	South	ROPAR	11KV	DS DIVN. KHARAR	SUB OFFICE GHARUAN	02513971	KANPUR shahed	AMR	OK	31.03.2023	Category 1				8221397	Not installed	0.000	NA	Director/D	
B.8463	South	ROPAR	11KV	DS DIVN. KHARAR	SUB OFFICE GHARUAN	C2527	RORA SHARED	AMR	OK	31.03.2023	Category 1				2046491	Not installed	0.000	NA	Director/D	
B.8464	South	ROPAR	11KV	DS DIVN. KHARAR	SUB OFFICE GHARUAN	11600265	Solar plant	AMR	OK	31.03.2023	Category 1				1512494	900-450/577/1-1-1	0.000	NA	Director/D	
B.8465	South	ROPAR	11KV	DS DIVN. KHARAR	SUB OFFICE GHARUAN	0265FL05	THERI	AMR	OK	31.03.2023	AP 3Phase 3Wire				2068149	900-450/577/1-1-1	2.640	NA	Director/D	
B.8466	South	ROPAR	11KV	DS DIVN. KHARAR	SUB OFFICE GHARUAN	0265FL61	Sakroldan	AMR	OK	31.03.2023	AP 3Phase 3Wire				4221007	900-450/577/1-1-1	2.749	NA	Director/D	
B.8467	South	ROPAR	11KV	DS DIVN. KHARAR	SUB OFFICE GHARUAN	0265FL03	CHAKALAN	AMR	OK	31.03.2023	AP 3Phase 3Wire				206783					

S.No	Zone	Circle	Voltage Level (kVA)	Division (kVA)	Sub-Division (kVA)	Feeder ID	Feeder Name	Feeder Metering Status (Metered/unmetered/AMR/AMI)	Status of Meter (Functional/Non-functional)	Metering Date (Date of last actual meter reading/communication)	Feeder Type (Agri./Industrial/Mixed)	Status of Communication			Period from 01.04.2021 to 31.03.2022				Sales	Remarks (Source of data)
												% data received through automatically if feeder AMR/AMI	Number of hours when meter was unable to communicate in overall	Total Number of hours in the period	Meter S.No	CT/PT ratio	Import (kWh)	Export (kWh)		
B.8506	South	ROPAR	66KV	DS DIVN. ANANDPUR SAHIB	S/D NANGAL	B8M2BF01	NFL	Not available	OK	31.03.2023	Category 4				Not available	Not available	1.753	NA	Director/D	
B.8507	South	ROPAR	66KV	DS DIVN. ANANDPUR SAHIB	S/D NANGAL	O255FF02	PAL	Not available	OK	31.03.2023	Category 4				Not available	Not available	4.488	NA	Director/D	
B.8508	South	ROPAR	66KV	DS DIVN. ANANDPUR SAHIB	S/D NANGAL	O255FH03	NFL	NON AMR	OK	31.03.2023	Category 4				Not available	Not available	328.580	NA	Director/D	
B.8509	South	ROPAR	11KV	DS DIVN. ANANDPUR SAHIB	S/D NURPUR BEDI	O278F005	KALIWAN	NON AMR	OK	31.03.2023	Kandi Mixed	4165	400-200/5-5	2.840	NA	Director/D				
B.8510	South	ROPAR	11KV	DS DIVN. ANANDPUR SAHIB	S/D NURPUR BEDI	O278F02	SWARA	NON AMR	OK	31.03.2023	Kandi Mixed	1589	400-200/5-5	4.163	NA	Director/D				
B.8511	South	ROPAR	11KV	DS DIVN. ANANDPUR SAHIB	S/D NURPUR BEDI	O278F03	PLATA	NON AMR	OK	31.03.2023	Kandi Mixed	1588	400-200/5-5	4.556	NA	Director/D				
B.8512	South	ROPAR	11KV	DS DIVN. ANANDPUR SAHIB	S/D NURPUR BEDI	O278F04	NALHOTI	NON AMR	OK	31.03.2023	Kandi Mixed	1739	400-200/5-5	5.022	NA	Director/D				
B.8513	South	ROPAR	11KV	DS DIVN. ANANDPUR SAHIB	S/D NURPUR BEDI	O278F01	BHANGLAN	AMR	OK	31.03.2023	Kandi Mixed	1678	400-200/5-5	7.992	NA	Director/D				
B.8514	South	ROPAR	11KV	DS DIVN. ANANDPUR SAHIB	S/D NURPUR BEDI	O266FL19	BARWA	AMR	OK	31.03.2023	Category 5-UPS	5490	900-450/577/1-1	0.000	NA	Director/D				
B.8515	South	ROPAR	11KV	DS DIVN. ANANDPUR SAHIB	S/D NURPUR BEDI	O266FL14	SAIDPUR	AMR	OK	31.03.2023	Kandi Mixed	2067022	900-450/577/1-1	2.370	NA	Director/D				
B.8516	South	ROPAR	11KV	DS DIVN. ANANDPUR SAHIB	S/D NURPUR BEDI	O266FL02	Thana	AMR	OK	31.03.2023	Kandi Mixed	2066943	900-450/577/1-1	2.973	NA	Director/D				
B.8517	South	ROPAR	11KV	DS DIVN. ANANDPUR SAHIB	S/D NURPUR BEDI	O266FL16	MUKARI	AMR	OK	31.03.2023	Kandi Mixed	2066729	900-450/577/1-1	3.931	NA	Director/D				
B.8518	South	ROPAR	11KV	DS DIVN. ANANDPUR SAHIB	S/D NURPUR BEDI	O266FL09	Haripur	AMR	OK	31.03.2023	Kandi Mixed	2068134	900-450/577/1-1	4.208	NA	Director/D				
B.8519	South	ROPAR	11KV	DS DIVN. ANANDPUR SAHIB	S/D NURPUR BEDI	O266FL08	Jhangran	AMR	OK	31.03.2023	Kandi Mixed	34443	900-450/577/1-1	4.276	NA	Director/D				
B.8520	South	ROPAR	11KV	DS DIVN. ANANDPUR SAHIB	S/D NURPUR BEDI	O266FL18	BHANI	AMR	OK	31.03.2023	Category 5-UPS	12345	900-450/577/1-1	5.193	NA	Director/D				
B.8521	South	ROPAR	11KV	DS DIVN. ANANDPUR SAHIB	S/D NURPUR BEDI	O257FL13	HIVATPUR	AMR	OK	31.03.2023	Kandi Mixed	3640	900-450/577/1-1	9.251	NA	Director/D				
B.8522	South	ROPAR	11KV	DS DIVN. ANANDPUR SAHIB	S/D NURPUR BEDI	O266FL01	Bassi	AMR	OK	31.03.2023	Kandi Mixed	3834	900-450/577/1-1	10.168	NA	Director/D				
B.8523	South	ROPAR	11KV	DS DIVN. ANANDPUR SAHIB	S/D NURPUR BEDI	O266FL04	Asmanpur	AMR	OK	31.03.2023	Kandi Mixed	2068741	900-450/577/1-1	10.339	NA	Director/D				
B.8524	South	ROPAR	11KV	DS DIVN. ANANDPUR SAHIB	S/D NURPUR BEDI	O266FL03	Nurpur Bedi	Not available	OK	31.03.2023	Kandi Mixed	2066978	900-450/577/1-1	10.714	NA	Director/D				
B.8525	South	ROPAR	11KV	DS DIVN. ANANDPUR SAHIB	S/D NURPUR BEDI	O266FL17	BHANI	Not available	OK	31.03.2023	Kandi Mixed	Not available	Not available	1.206	NA	Director/D				
B.8526	South	ROPAR	11KV	DS DIVN. ANANDPUR SAHIB	SUB OFFICE TAKHATGARH	O267FL09	ABIANA	AMR	OK	31.03.2023	Category 5-UPS	4489	900-450/577/1-1	1.441	NA	Director/D				
B.8527	South	ROPAR	11KV	DS DIVN. ANANDPUR SAHIB	SUB OFFICE TAKHATGARH	O267FL08	Bhatton	AMR	OK	31.03.2023	Category 5-UPS	2066640	900-450/577/1-1	4.746	NA	Director/D				
B.8528	South	ROPAR	11KV	DS DIVN. ANANDPUR SAHIB	SUB OFFICE TAKHATGARH	O267FL02	BAINS	AMR	OK	31.03.2023	Kandi Mixed	2067714	900-450/577/1-1	5.408	NA	Director/D				
B.8529	South	ROPAR	11KV	DS DIVN. ANANDPUR SAHIB	SUB OFFICE TAKHATGARH	O267FL04	SRAIN	AMR	OK	31.03.2023	Kandi Mixed	33634	900-450/577/1-1	6.674	NA	Director/D				
B.8530	South	ROPAR	11KV	DS DIVN. ANANDPUR SAHIB	SUB OFFICE TAKHATGARH	O267FL03	TIBBA TAPPRIAN	AMR	OK	31.03.2023	Kandi Mixed	2066894	900-450/577/1-1	6.950	NA	Director/D				
B.8531	South	ROPAR	11KV	DS DIVN. ANANDPUR SAHIB	SUB OFFICE TAKHATGARH	O267FL01	HJANDIAN	AMR	OK	31.03.2023	Kandi Mixed	10268379	900-450/577/1-1	10.240	NA	Director/D				
B.8532	South	ROPAR	11KV	DS DIVN. ROPAR	S/D BELA	C253FL30	11 KV Bheeton Majra	AMR	OK	31.03.2023	AP 3Phase 3Wire	5444	Not installed	0.010	NA	Director/D				
B.8533	South	ROPAR	11KV	DS DIVN. ROPAR	S/D BELA	C253FL05	BALRAM PWIR	AMR	OK	31.03.2023	AP 3Phase 3Wire	8222650	Not installed	1.459	NA	Director/D				
B.8534	South	ROPAR	11KV	DS DIVN. ROPAR	S/D BELA	C253FL01	Bela	AMR	OK	31.03.2023	AP 3Phase 3Wire	7336810	Not installed	1.876	NA	Director/D				
B.8535	South	ROPAR	11KV	DS DIVN. ROPAR	S/D BELA	C253FL26	11KV KHERI	AMR	OK	31.03.2023	AP 3Phase 3Wire	33330	Not installed	1.932	NA	Director/D				
B.8536	South	ROPAR	11KV	DS DIVN. ROPAR	S/D BELA	C253FL15	Manjeet Pura	AMR	OK	31.03.2023	Category 5-UPS	9152612	Not installed	7.239	NA	Director/D				
B.8537	South	ROPAR	11KV	DS DIVN. ROPAR	S/D BELA	C253FL09	JATANA	AMR	OK	31.03.2023	Category 5-UPS	4187958	Not installed	9.762	NA	Director/D				
B.8538	South	ROPAR	11KV	DS DIVN. ROPAR	S/D BELA	O273FL04	Tapasri Amar Singh	NON AMR	OK	31.03.2023	AP 3Phase 3Wire	31135	200-100/5-5	0.437	NA	Director/D				
B.8539	South	ROPAR	11KV	DS DIVN. ROPAR	S/D BELA	O273FL05	11KV land Sahib	AMR	OK	31.03.2023	AP 3Phase 3Wire	37135	200-100/5-5	0.569	NA	Director/D				
B.8540	South	ROPAR	11KV	DS DIVN. ROPAR	S/D BELA	O273FL03	11KV Makhowal	AMR	OK	31.03.2023	AP 3Phase 3Wire	37186	200-100/5-5	0.648	NA	Director/D				
B.8541	South	ROPAR	11KV	DS DIVN. ROPAR	S/D BELA	O273FL01	Beharmpur Bet	AMR	OK	31.03.2023	AP 3Phase 3Wire	37137	200-100/5-5	1.247	NA	Director/D				
B.8542	South	ROPAR	11KV	DS DIVN. ROPAR	S/D BELA	O273FL06	Shri Guro Harjot Singh	AMR	OK	31.03.2023	Category 4	93112	200-100/5-5	2.330	NA	Director/D				
B.8543	South	ROPAR	11KV	DS DIVN. ROPAR	S/D BELA	O273FL02	11KV Mohan Majra	AMR	OK	31.03.2023	Category 5-UPS	37085	200-100/5-5	4.799	NA	Director/D				
B.8544	South	ROPAR	11KV	DS DIVN. ROPAR	S/D CHAMKAUR SAHIB	C253FL21	11 KV Sub Station	AMR	OK	31.03.2023	Substation Transformer	33330	Not installed	0.019	NA	Director/D				
B.8545	South	ROPAR	11KV	DS DIVN. ROPAR	S/D CHAMKAUR SAHIB	C253FL10	PSTC	AMR	OK	31.03.2023	AP 3Phase 3Wire	5388175	Not installed	1.392	NA	Director/D				
B.8546	South	ROPAR	11KV	DS DIVN. ROPAR	S/D CHAMKAUR SAHIB	C253FL17	11KV Ranghar	AMR	OK	31.03.2023	AP 3Phase 3Wire	33423	Not installed	1.778	NA	Director/D				
B.8547	South	ROPAR	11KV	DS DIVN. ROPAR	S/D CHAMKAUR SAHIB	C253FL20	11KV Dholran	AMR	OK	31.03.2023	AP 3Phase 3Wire	10273765	Not installed	1.805	NA	Director/D				
B.8548	South	ROPAR	11KV	DS DIVN. ROPAR	S/D CHAMKAUR SAHIB	C253FL12	11KV Kheer	AMR	OK	31.03.2023	AP 3Phase 3Wire	6740795	Not installed	1.011	NA	Director/D				
B.8549	South	ROPAR	11KV	DS DIVN. ROPAR	S/D CHAMKAUR SAHIB	C253FL22	11 KV Sandhuan UPS	AMR	OK	31.03.2023	Category 5-UPS	5430	Not installed	2.055	NA	Director/D				
B.8550	South	ROPAR	11KV	DS DIVN. ROPAR	S/D CHAMKAUR SAHIB	C253FL04	SALEM PUR	AMR	OK	31.03.2023	AP 3Phase 3Wire	9141086	Not installed	2.187	NA	Director/D				
B.8551	South	ROPAR	11KV	DS DIVN. ROPAR	S/D CHAMKAUR SAHIB	C253FL19	Kotli	AMR	OK	31.03.2023	AP 3Phase 3Wire	10273765	Not installed	2.190	NA	Director/D				
B.8552	South	ROPAR	11KV	DS DIVN. ROPAR	S/D CHAMKAUR SAHIB	C253FL16	AMBALI	AMR	OK	31.03.2023	AP 3Phase 3Wire	9154432	Not installed	2.263	NA	Director/D				
B.8553	South	ROPAR	11KV	DS DIVN. ROPAR	S/D CHAMKAUR SAHIB	C253FL07	MANEEL	AMR	OK	31.03.2023	AP 3Phase 3Wire	2067656	Not installed	2.208	NA	Director/D				
B.8554	South	ROPAR	11KV	DS DIVN. ROPAR	S/D CHAMKAUR SAHIB	C253FL06	KANDHOLA	AMR	OK	31.03.2023	AP 3Phase 3Wire	8223266	Not installed	2.386	NA	Director/D				
B.8555	South	ROPAR	11KV	DS DIVN. ROPAR	S/D CHAMKAUR SAHIB	C253FL02	MANEEL	AMR	OK	31.03.2023	AP 3Phase 3Wire	8222650	Not installed	2.561	NA	Director/D				
B.8556	South	ROPAR	11KV	DS DIVN. ROPAR	S/D CHAMKAUR SAHIB	C253FL13	HAWARA	AMR	OK	31.03.2023	AP 3Phase 3Wire	4187149	Not installed	2.613	NA	Director/D				
B.8557	South	ROPAR	11KV	DS DIVN. ROPAR	S/D CHAMKAUR SAHIB	C253FL11	BASSI	AMR	OK	31.03.2023	AP 3Phase 3Wire	9140843	Not installed	2.777	NA	Director/D				
B.8558	South	ROPAR	11KV	DS DIVN. ROPAR	S/D CHAMKAUR SAHIB	C253FL08	CHAMKAUR SAHIB	AMR	OK	31.03.2023	Category 1	2067887	Not installed	8.214	NA	Director/D				
B.8559	South	ROPAR	11KV	DS DIVN. ROPAR	S/D CHAMKAUR SAHIB	C253FL14	ANAZ MANDI	AMR	OK	31.03.2023	Category 1	8223219	Not installed	8.723	NA	Director/D				
B.8560	South	ROPAR	11KV	DS DIVN. ROPAR	S/D CHAMKAUR SAHIB	C253FL03	UNAZ	AMR	OK	31.03.2023	Category 5-UPS	8223261	Not installed	11.340	NA	Director/D				
B.8561	South	ROPAR	11KV	DS DIVN. ROPAR	S/D CHAMKAUR SAHIB	C253FL18	NAVODYA	AMR	OK	31.03.2023	Category 5-UPS	8223725	Not installed	11.711	NA	Director/D				
B.8562	South	ROPAR	11KV	DS DIVN. ROPAR	S/D CHAMKAUR SAHIB	O267FL02	SHANT PUR	AMR	OK	31.03.2023	AP 3Phase 3Wire	2068289	Not installed	2.199	NA	Director/D				
B.8563	South	ROPAR	11KV	DS DIVN. ROPAR	S/D CHAMKAUR SAHIB	O267FL07	MAKRONA	NON AMR	OK	31.03.2023	AP 3Phase 3Wire	9534571	Not installed	2.595	NA	Director/D				
B.8564	South	ROPAR	11KV	DS DIVN. ROPAR	S/D CHAMKAUR SAHIB	O267FL12	Rohla Majra	AMR	OK	31.03.2023	AP 3Phase 3Wire	9153271	Not installed	2.601	NA	Director/D				
B.8565	South	ROPAR	11KV	DS DIVN. ROPAR	S/D CHAMKAUR SAHIB	O267FL08	SAMMA SHEHRI	AMR	OK	31.03.2023	Category 5-UPS	9154370	Not installed	2.082	NA	Director/D				
B.8566	South	ROPAR	11KV	DS DIVN. ROPAR	S/D GHANOLI	C253FL05	RTP	AMR	OK	31.03.2023	Kandi Mixed									

S.No	Zone	Circle	Voltage Level (kVA)	Division (kVA)	Sub-Division (kVA)	Feeder ID	Feeder Name	Feeder Metering Status (Metered/unmetered/AMR/AMI)	Status of Meter (Functional/Non-Functional)	Metering Date (Date of last actual meter reading/communication)	Feeder Type (Agr/Industrial/Mixed)	Status of Communication			Period from 01.04.2021 to 31.03.2022				Sales	Remarks (Source of data)
												% data received through automatically by feeder AMR/AMI	Number of hours when meter was unable to communicate in overall	Total Number of hours in the period	Meter S.No	CT/PT ratio	Import (kU)	Export (kU)		
B.8603	South	ROPAR	132KV	DS DIVN. ROPAR	DS S/D ROPAR	C256FL02	MAX INDIA	Not available	OK	31.03.2023	Category 4				Not available	Not available	86.935	NA	Director/D	
B.8604	South	ROPAR	132KV	DS DIVN. ROPAR	DS S/D ROPAR	C256FL03	RANBAY	AMR	OK	31.03.2023	Category 4				Not available	Not available	93.561	NA	Director/D	
B.8605	South	ROPAR	11KV	DS DIVN. ROPAR	DS S/D SUKHRAMPUR	F103CZ56	NILET	AMR	OK	31.03.2023	Category 1				2068386	Not installed	3.556	NA	Director/D	
B.8606	South	ROPAR	11KV	DS DIVN. ROPAR	DS S/D SUKHRAMPUR	C251FL20	11KV Aatturpur	AMR	OK	31.03.2023	Category 1				2062950	Not installed	0.000	NA	Director/D	
B.8607	South	ROPAR	11KV	DS DIVN. ROPAR	DS S/D SUKHRAMPUR	C251FL14	132/RTPT COLONY	AMR	OK	31.03.2023	Category 1				6485410	Not installed	1.053	NA	Director/D	
B.8608	South	ROPAR	11KV	DS DIVN. ROPAR	DS S/D SUKHRAMPUR	C251FL07	11KV Sangtपुरा	AMR	OK	31.03.2023	AP 3Phase 3Wire				5437714	Not installed	1.708	NA	Director/D	
B.8609	South	ROPAR	11KV	DS DIVN. ROPAR	DS S/D SUKHRAMPUR	C251FL11	P S T C	AMR	OK	31.03.2023	AP 3Phase 3Wire				8223409	Not installed	1.986	NA	Director/D	
B.8610	South	ROPAR	11KV	DS DIVN. ROPAR	DS S/D SUKHRAMPUR	C251FL12	JHALLIAN KALAN	AMR	OK	31.03.2023	AP 3Phase 3Wire				5437714	Not installed	2.616	NA	Director/D	
B.8611	South	ROPAR	11KV	DS DIVN. ROPAR	DS S/D SUKHRAMPUR	C251FL10	BIRLA	AMR	OK	31.03.2023	AP 3Phase 3Wire				8223407	Not installed	2.810	NA	Director/D	
B.8612	South	ROPAR	11KV	DS DIVN. ROPAR	DS S/D SUKHRAMPUR	C251FL08	BEHRAM PUR	AMR	OK	31.03.2023	Kandi Mixed				5388135	Not installed	4.353	NA	Director/D	
B.8613	South	ROPAR	11KV	DS DIVN. ROPAR	DS S/D SUKHRAMPUR	C251FL13	UPS-1	AMR	OK	31.03.2023	Category 5-UPS				5342138	Not installed	7.602	NA	Director/D	
B.8614	South	ROPAR	11KV	DS DIVN. ROPAR	DS S/D SUKHRAMPUR	C251FL15	UPS-1	AMR	OK	31.03.2023	Category 5-UPS				2068250	Not installed	9.404	NA	Director/D	
B.8615	South	ROPAR	11KV	DS DIVN. ROPAR	DS S/D SUKHRAMPUR	C251FL21	11KV Mega Star	AMR	OK	31.03.2023	Category 2				32563	Not installed	10.077	NA	Director/D	
B.8616	South	ROPAR	11KV	DS DIVN. ROPAR	DS S/D SUKHRAMPUR	0262FL11	DULCHI MAURA	AMR	OK	31.03.2023	Kandi Mixed				15154521	Not installed	2.867	NA	Director/D	
B.8617	South	ROPAR	11KV	DS DIVN. ROPAR	DS S/D SUKHRAMPUR	C252FL06	LOHAR	AMR	OK	31.03.2023	Kandi Mixed				2067619	Not installed	4.568	NA	Director/D	
B.8618	South	ROPAR	11KV	DS DIVN. ROPAR	DS S/D SUKHRAMPUR	0262FL19	11KV ATALGARH	AMR	OK	31.03.2023	Category 1				5226	Not installed	4.717	NA	Director/D	
B.8619	South	ROPAR	11KV	DS DIVN. ROPAR	DS S/D SUKHRAMPUR	0262FL22	11KV Khabra UPS	Not available	OK	31.03.2023	Category 1				16199369	Not installed	7.303	NA	Director/D	
B.8620	South	ROPAR	66KV	DS DIVN. ROPAR	DS S/D SUKHRAMPUR	C251SL15	HT Ropar	AMR	OK	31.03.2023	Category 2				Not available	Not available	9.972	NA	Director/D	
B.8621	South	ROPAR	11KV	DS DIVN. SAMRALA	BEHLOLPUR	0263FL01	11 KV Kacha Machiwara	AMR	OK	31.03.2023	AP 3Phase 3Wire				9141157	1200-600/5	0.969	NA	Director/D	
B.8622	South	ROPAR	11KV	DS DIVN. SAMRALA	BEHLOLPUR	0263FL10	Mahotran	AMR	OK	31.03.2023	AP 3Phase 3Wire				914158	1200-600/5	0.993	NA	Director/D	
B.8623	South	ROPAR	11KV	DS DIVN. SAMRALA	BEHLOLPUR	0263FL07	11 KV Rajpur	AMR	OK	31.03.2023	AP 3Phase 3Wire				6699554	1200-600/5	1.900	NA	Director/D	
B.8624	South	ROPAR	11KV	DS DIVN. SAMRALA	BEHLOLPUR	0263FL04	11 KV Pawat	AMR	OK	31.03.2023	AP 3Phase 3Wire				6486426	1200-600/5	2.101	NA	Director/D	
B.8625	South	ROPAR	11KV	DS DIVN. SAMRALA	BEHLOLPUR	0263FL03	11 KV Kishanpura	AMR	OK	31.03.2023	AP 3Phase 3Wire				9141159	1200-600/5	2.237	NA	Director/D	
B.8626	South	ROPAR	11KV	DS DIVN. SAMRALA	BEHLOLPUR	0263FL05	11 KV Bharma	AMR	OK	31.03.2023	AP 3Phase 3Wire				9141160	1200-600/5	2.239	NA	Director/D	
B.8627	South	ROPAR	11KV	DS DIVN. SAMRALA	BEHLOLPUR	0263FL08	11KV PSTC	NON AMR	OK	31.03.2023	AP 3Phase 3Wire				3442	1200-600/5	2.291	NA	Director/D	
B.8628	South	ROPAR	11KV	DS DIVN. SAMRALA	BEHLOLPUR	0263FL11	11 KV Kori Affgana	AMR	OK	31.03.2023	Category 5-UPS				910134	1200-600/5	3.151	NA	Director/D	
B.8629	South	ROPAR	11KV	DS DIVN. SAMRALA	BEHLOLPUR	0263FL09	11KV Naanowal (UPS)	AMR	OK	31.03.2023	Category 5-UPS				9094698	1200-600/5	6.279	NA	Director/D	
B.8630	South	ROPAR	11KV	DS DIVN. SAMRALA	BEHLOLPUR	0263FL06	11 KV Shatagwal	AMR	OK	31.03.2023	Category 5-UPS				4221134	1200-600/5	7.507	NA	Director/D	
B.8631	South	ROPAR	11KV	DS DIVN. SAMRALA	BEHLOLPUR	0264FL06	11 KV Sherpur	AMR	OK	31.03.2023	AP 3Phase 3Wire				6675536	900-450/577/1-1-1	1.807	NA	Director/D	
B.8632	South	ROPAR	11KV	DS DIVN. SAMRALA	DS S/D CITY SAMRALA	C104FL18	Chahlian	AMR	OK	31.03.2023	AP 3Phase 3Wire				6036	Not installed	0.922	NA	Director/D	
B.8633	South	ROPAR	11KV	DS DIVN. SAMRALA	DS S/D CITY SAMRALA	C104FL22	BULPUR AP	AMR	OK	31.03.2023	AP 3Phase 3Wire				5439	400-200/5-5	1.105	NA	Director/D	
B.8634	South	ROPAR	11KV	DS DIVN. SAMRALA	DS S/D CITY SAMRALA	C104FL03	11 KV Dyalpur	AMR	OK	31.03.2023	AP 3Phase 3Wire				8094281	Not installed	1.326	NA	Director/D	
B.8635	South	ROPAR	11KV	DS DIVN. SAMRALA	DS S/D CITY SAMRALA	C104FL06	11 KV Rural Samrala	AMR	OK	31.03.2023	AP 3Phase 3Wire				2047081	Not installed	1.793	NA	Director/D	
B.8636	South	ROPAR	11KV	DS DIVN. SAMRALA	DS S/D CITY SAMRALA	C104FL01	11 KV Dhindsa	AMR	OK	31.03.2023	AP 3Phase 3Wire				9094276	Not installed	1.801	NA	Director/D	
B.8637	South	ROPAR	11KV	DS DIVN. SAMRALA	DS S/D CITY SAMRALA	C104FL11	11 KV PSTC-2	AMR	OK	31.03.2023	AP 3Phase 3Wire				9094647	Not installed	2.019	NA	Director/D	
B.8638	South	ROPAR	11KV	DS DIVN. SAMRALA	DS S/D CITY SAMRALA	C104FL20	11KV Gopi Mall Kaur Sain	AMR	OK	31.03.2023	Category 2				9141146	400-200/5-5	5.198	NA	Director/D	
B.8639	South	ROPAR	11KV	DS DIVN. SAMRALA	DS S/D CITY SAMRALA	C104FL08	11 KV Ghulal	AMR	OK	31.03.2023	Category 5-UPS				11116772	Not installed	9.827	NA	Director/D	
B.8640	South	ROPAR	11KV	DS DIVN. SAMRALA	DS S/D CITY SAMRALA	C104FL21	Behloipur Road City Samrala	AMR	OK	31.03.2023	Category 1				7183379	Not installed	11.055	NA	Director/D	
B.8641	South	ROPAR	11KV	DS DIVN. SAMRALA	DS S/D CITY SAMRALA	C104FL02	11 KV Bhani Sahib	AMR	OK	31.03.2023	Category 1				11117262	Not installed	14.505	NA	Director/D	
B.8642	South	ROPAR	11KV	DS DIVN. SAMRALA	DS S/D CITY SAMRALA	C104FL05	11 KV City-1	AMR	OK	31.03.2023	Category 1				9094281	400-200/5-5	16.515	NA	Director/D	
B.8643	South	ROPAR	11KV	DS DIVN. SAMRALA	DS S/D CITY SAMRALA	C105FL06	11 KV B.R.Spinner	AMR	OK	31.03.2023	Category 2				11116937	Not installed	0.000	NA	Director/D	
B.8644	South	ROPAR	11KV	DS DIVN. SAMRALA	DS S/D CITY SAMRALA	C105FL12	Rajewal AP	AMR	OK	31.03.2023	AP 3Phase 3Wire				5308	Not installed	1.436	NA	Director/D	
B.8645	South	ROPAR	11KV	DS DIVN. SAMRALA	DS S/D CITY SAMRALA	C105FL01	11 KV Shamshpur	AMR	OK	31.03.2023	AP 3Phase 3Wire				8223265	Not installed	1.598	NA	Director/D	
B.8646	South	ROPAR	11KV	DS DIVN. SAMRALA	DS S/D CITY SAMRALA	C105FL11	Otalain	AMR	OK	31.03.2023	AP 3Phase 3Wire				73142076	400-200/5-5	2.192	NA	Director/D	
B.8647	South	ROPAR	11KV	DS DIVN. SAMRALA	DS S/D CITY SAMRALA	C105FL08	11 KV Aliod	AMR	OK	31.03.2023	AP 3Phase 3Wire				2068581	400-200/5-5	2.241	NA	Director/D	
B.8648	South	ROPAR	11KV	DS DIVN. SAMRALA	DS S/D CITY SAMRALA	C105FL03	11 KV Bhagwanpura	AMR	OK	31.03.2023	AP 3Phase 3Wire				2066412	Not installed	2.401	NA	Director/D	
B.8649	South	ROPAR	11KV	DS DIVN. SAMRALA	DS S/D CITY SAMRALA	C105FL09	11 KV Shangang	AMR	OK	31.03.2023	Category 5-UPS				10273785	Not installed	2.449	NA	Director/D	
B.8650	South	ROPAR	11KV	DS DIVN. SAMRALA	DS S/D CITY SAMRALA	C105FL05	11 KV Nigra	AMR	OK	31.03.2023	AP 3Phase 3Wire				8223265	Not installed	2.495	NA	Director/D	
B.8651	South	ROPAR	11KV	DS DIVN. SAMRALA	DS S/D CITY SAMRALA	C105FL10	Manjhil	AMR	OK	31.03.2023	AP 3Phase 3Wire				8223265	Not installed	2.686	NA	Director/D	
B.8652	South	ROPAR	11KV	DS DIVN. SAMRALA	DS S/D CITY SAMRALA	C105FL05	11 KV Dhindsa	AMR	OK	31.03.2023	Category 5-UPS				11116988	400-200/5-5	5.286	NA	Director/D	
B.8653	South	ROPAR	11KV	DS DIVN. SAMRALA	DS S/D CITY SAMRALA	C255FL12	11 KV Diwala	AMR	OK	31.03.2023	Category 5-UPS				2068581	Not installed	8.271	NA	Director/D	
B.8654	South	ROPAR	11KV	DS DIVN. SAMRALA	DS S/D CITY SAMRALA	C105FL04	11 KV City-2	Not available	OK	31.03.2023	Category 2				11116737	Not installed	14.000	NA	Director/D	
B.8655	South	ROPAR	66KV	DS DIVN. SAMRALA	DS S/D CITY SAMRALA	C254034	Mittal Spinning	AMR	OK	31.03.2023	Category 4				Not available	Not available	6.001	NA	Director/D	
B.8656	South	ROPAR	11KV	DS DIVN. SAMRALA	DS S/D CITY SAMRALA	C104FL10	11KV No.1	AMR	OK	31.03.2023	AP 3Phase 3Wire				2067410	400-200/5-5	1.827	NA	Director/D	
B.8657	South	ROPAR	11KV	DS DIVN. SAMRALA	DS S/D CITY SAMRALA	C104FL15	11 KV Kotala	AMR	OK	31.03.2023	AP 3Phase 3Wire				9094277	Not installed	2.116	NA	Director/D	
B.8658	South	ROPAR	11KV	DS DIVN. SAMRALA	DS S/D CITY SAMRALA	C104FL19	Palmaira	AMR	OK	31.03.2023	Category 5-UPS				5262523	Not installed	4.525	NA	Director/D	
B.8659	South	ROPAR	11KV	DS DIVN. SAMRALA	DS S/D CITY SAMRALA	C105FL07	11 KV Kulewal	AMR	OK	31.03.2023	AP 3Phase 3Wire				8222530	400-200/5-5	1.952	NA	Director/D	
B.8660	South	ROPAR	11KV	DS DIVN. SAMRALA	DS S/D CITY SAMRALA	0257FL21	Mushkabad	AMR	OK	31.03.2023	AP 3Phase 3Wire				2047183	Not installed	0.032	NA	Director/D	
B.8661	South	ROPAR	11KV	DS DIVN. SAMRALA	DS S/D CITY SAMRALA	0257FL01	11 KV Dyalpur	AMR	OK	31.03.2023	AP 3Phase 3Wire				132545	Not installed	0.647	NA	Director/D	
B.8662	South	ROPAR	11KV	DS DIVN. SAMRALA	DS S/D CITY SAMRALA	0257FL05	11 KV Sihal	AMR	OK	31.03.2023	AP 3Phase 3Wire				8222746	Not installed	1.287	NA	Director/D	
B.8663	South	ROPAR	11KV	DS DIVN. SAMRALA	DS S/D CITY SAMRALA	0257FL18	Bondali	AMR												

S.No	Zone	Circle	Voltage Level (kVA)	Division (kVA)	Sub-Division (kVA)	Feeder ID	Feeder Name	Feeder Metering Status (Metered/unmetered/AMR/AMI)	Status of Meter (Functional/Non-Functional)	Metering Date (Date of last actual meter reading/communication)	Feeder Type (Agr/Industrial/Mixed)	Status of Communication			Period from 01.04.2021to 31.03.2022				Sales	Remarks (Source of data)
												% data received through automatically by feeder AMR/AMI	Number of hours when meter was unable to communicate in overall	Total Number of hours in the period	Meter S.No	CT/PT ratio	Import (kU)	Export (kU)		
B.8700	South	ROPAR	11KV	D5 DIVN. SAMRALA	KHAMANO	0256FL21	11kv Station T/J khmano	AMR	OK	31.03.2023	Category 1				11117181	1200/577/1-1-1	0.035		NA	Director/D
B.8701	South	ROPAR	11KV	D5 DIVN. SAMRALA	KHAMANO	0256FL10	11 KV Luxmi	AMR	OK	31.03.2023	Category 1				6489741	1200/577/1-1-1	0.363		NA	Director/D
B.8702	South	ROPAR	11KV	D5 DIVN. SAMRALA	KHAMANO	0256FL14	11KV AMANGARH	AMR	OK	31.03.2023	AP 3Phase 3Wire				11117317	1200/577/1-1-1	1.667		NA	Director/D
B.8703	South	ROPAR	11KV	D5 DIVN. SAMRALA	KHAMANO	0256FL13	11 KV KAMELA	AMR	OK	31.03.2023	AP 3Phase 3Wire				8156551	1200/577/1-1-1	1.820		NA	Director/D
B.8704	South	ROPAR	11KV	D5 DIVN. SAMRALA	KHAMANO	0256FL02	11 KV Kakrala	AMR	OK	31.03.2023	AP 3Phase 3Wire				8222750	1200/577/1-1-1	2.173		NA	Director/D
B.8705	South	ROPAR	11KV	D5 DIVN. SAMRALA	KHAMANO	0256FL07	11 KV Badeshan	AMR	OK	31.03.2023	AP 3Phase 3Wire				2068214	1200/577/1-1-1	2.196		NA	Director/D
B.8706	South	ROPAR	11KV	D5 DIVN. SAMRALA	KHAMANO	0256FL12	11 KV MAHESHPURA	AMR	OK	31.03.2023	AP 3Phase 3Wire				2067351	1200/577/1-1-1	2.292		NA	Director/D
B.8707	South	ROPAR	11KV	D5 DIVN. SAMRALA	KHAMANO	0256FL04	11 KV Manderan	AMR	OK	31.03.2023	AP 3Phase 3Wire				8223537	1200/577/1-1-1	2.320		NA	Director/D
B.8708	South	ROPAR	11KV	D5 DIVN. SAMRALA	KHAMANO	0256FL20	11KV Yuban Milk Food	AMR	OK	31.03.2023	Category 2				15194703	1200/577/1-1-1	2.352		NA	Director/D
B.8709	South	ROPAR	11KV	D5 DIVN. SAMRALA	KHAMANO	0256FL09	11 KV Amrala	AMR	OK	31.03.2023	AP 3Phase 3Wire				2068518	1200/577/1-1-1	2.365		NA	Director/D
B.8710	South	ROPAR	11KV	D5 DIVN. SAMRALA	KHAMANO	0256FL05	11 KV Lakhnapur	AMR	OK	31.03.2023	AP 3Phase 3Wire				2068428	1200/577/1-1-1	2.477		NA	Director/D
B.8711	South	ROPAR	11KV	D5 DIVN. SAMRALA	KHAMANO	0256FL01	11 KV Sanghol	AMR	OK	31.03.2023	AP 3Phase 3Wire				11117113	1200/577/1-1-1	2.614		NA	Director/D
B.8712	South	ROPAR	11KV	D5 DIVN. SAMRALA	KHAMANO	0256FL08	11 KV Mohan Majra	AMR	OK	31.03.2023	AP 3Phase 3Wire				2066649	1200/577/1-1-1	2.696		NA	Director/D
B.8713	South	ROPAR	11KV	D5 DIVN. SAMRALA	KHAMANO	0256FL03	11 KV Khamano	AMR	OK	31.03.2023	Category 1				2067649	1200/577/1-1-1	5.107		NA	Director/D
B.8714	South	ROPAR	11KV	D5 DIVN. SAMRALA	KHAMANO	0256FL11	11 KV Manosopur	AMR	OK	31.03.2023	Category 5 UPS				10273788	1200/577/1-1-1	6.865		NA	Director/D
B.8715	South	ROPAR	11KV	D5 DIVN. SAMRALA	KHAMANO	0256FL15	11 KV Bhandini	AMR	OK	31.03.2023	Category 1				11117181	1200/577/1-1-1	7.190		NA	Director/D
B.8716	South	ROPAR	11KV	D5 DIVN. SAMRALA	KHAMANO	0256FL22	Khamanon Khurd	AMR	OK	31.03.2023	Category 1				73192310	1200/577/1-1-1	9.268		NA	Director/D
B.8717	South	ROPAR	11KV	D5 DIVN. SAMRALA	KHAMANO	0256FL06	11 KV Navodya	AMR	OK	31.03.2023	Category 1				2067733	1200/577/1-1-1	10.012		NA	Director/D
B.8718	South	ROPAR	11KV	D5 DIVN. SAMRALA	KOHARA	8252FL15	11 KV Sunpogy Feb	AMR	OK	31.03.2023	Category 4				6679964	400-200/5-5	0.000		NA	Director/D
B.8719	South	ROPAR	11KV	D5 DIVN. SAMRALA	KOHARA	8252FL08	11 KV Sugar Mill	AMR	OK	31.03.2023	Category 2				2062465	Not installed	0.000		NA	Director/D
B.8720	South	ROPAR	11KV	D5 DIVN. SAMRALA	KOHARA	8252FL14	11KV Romas	NON AMR	OK	31.03.2023	Category 3				9141112	Not installed	0.000		NA	Director/D
B.8721	South	ROPAR	11KV	D5 DIVN. SAMRALA	KOHARA	8252FL99	11 KV S/5t Kohara	AMR	OK	31.03.2023	Substation Transformer				123456	Not installed	0.098		NA	Director/D
B.8722	South	ROPAR	11KV	D5 DIVN. SAMRALA	KOHARA	8252FL14	Agrotech India	AMR	OK	31.03.2023	Category 2				11117325	Not installed	0.188		NA	Director/D
B.8723	South	ROPAR	11KV	D5 DIVN. SAMRALA	KOHARA	8252FL17	11KV Budhewal AP	AMR	OK	31.03.2023	AP 3Phase 3Wire				549	Not installed	0.748		NA	Director/D
B.8724	South	ROPAR	11KV	D5 DIVN. SAMRALA	KOHARA	8252FL05	11 KV Kohara	AMR	OK	31.03.2023	AP 3Phase 3Wire				9140841	400-200/5-5	1.512		NA	Director/D
B.8725	South	ROPAR	11KV	D5 DIVN. SAMRALA	KOHARA	8252FL04	11 KV Lakhowal	AMR	OK	31.03.2023	AP 3Phase 3Wire				9154292	Not installed	2.215		NA	Director/D
B.8726	South	ROPAR	11KV	D5 DIVN. SAMRALA	KOHARA	8252FL38	11KV Lakhowal Road	AMR	OK	31.03.2023	Category 2				5225	Not installed	2.455		NA	Director/D
B.8727	South	ROPAR	11KV	D5 DIVN. SAMRALA	KOHARA	8252FL06	11 KV Dhanaansu	AMR	OK	31.03.2023	AP 3Phase 3Wire				9141087	400-200/5-5	2.483		NA	Director/D
B.8728	South	ROPAR	11KV	D5 DIVN. SAMRALA	KOHARA	8252FL35	RPK Alloys	AMR	OK	31.03.2023	Category 3				2068441	Not installed	2.521		NA	Director/D
B.8729	South	ROPAR	11KV	D5 DIVN. SAMRALA	KOHARA	8252FL18	11 KV Prime Steel	AMR	OK	31.03.2023	Category 2				11116777	Not installed	3.080		NA	Director/D
B.8730	South	ROPAR	11KV	D5 DIVN. SAMRALA	KOHARA	8252FL03	11 KV Punjab Worsted	AMR	OK	31.03.2023	Category 4				2068259	400-200/5-5	3.177		NA	Director/D
B.8731	South	ROPAR	11KV	D5 DIVN. SAMRALA	KOHARA	8252FL14	11KV Samindhi Steel	AMR	OK	31.03.2023	Category 2				10273787	Not installed	3.185		NA	Director/D
B.8732	South	ROPAR	11KV	D5 DIVN. SAMRALA	KOHARA	8252FL01	NKH Oid	AMR	OK	31.03.2023	Category 2				2068441	Not installed	3.517		NA	Director/D
B.8733	South	ROPAR	11KV	D5 DIVN. SAMRALA	KOHARA	8252FL27	Mohit Furnace	AMR	OK	31.03.2023	Category 2				30310	Not installed	4.113		NA	Director/D
B.8734	South	ROPAR	11KV	D5 DIVN. SAMRALA	KOHARA	8252FL02	11 KV Raj & Sandeep	NON AMR	OK	31.03.2023	Category 3				6740695	400-200/5-5	4.721		NA	Director/D
B.8735	South	ROPAR	11KV	D5 DIVN. SAMRALA	KOHARA	8252FL30	Dhanaansu Urban	AMR	OK	31.03.2023	Category 5 UPS				23318	Not installed	5.277		NA	Director/D
B.8736	South	ROPAR	11KV	D5 DIVN. SAMRALA	KOHARA	8252FL37	Maha Laxmi Spinning Mills	AMR	OK	31.03.2023	Category 4				3925	Not installed	5.975		NA	Director/D
B.8737	South	ROPAR	11KV	D5 DIVN. SAMRALA	KOHARA	8252FL12	Kohara Industry	AMR	OK	31.03.2023	Category 4				12039358	Not installed	6.028		NA	Director/D
B.8738	South	ROPAR	11KV	D5 DIVN. SAMRALA	KOHARA	8252FL31	Vaishno	AMR	OK	31.03.2023	Category 2				23686	Not installed	6.138		NA	Director/D
B.8739	South	ROPAR	11KV	D5 DIVN. SAMRALA	KOHARA	8252FL28	Kamdhenu	AMR	OK	31.03.2023	Category 2				848838	400-200/5-5	6.284		NA	Director/D
B.8740	South	ROPAR	11KV	D5 DIVN. SAMRALA	KOHARA	8252FL32	kohara urban	AMR	OK	31.03.2023	Category 5 UPS				2066332	400-200/5-5	6.759		NA	Director/D
B.8741	South	ROPAR	11KV	D5 DIVN. SAMRALA	KOHARA	8252FL33	Gurtej Steel	AMR	OK	31.03.2023	Category 3				12345	Not installed	9.537		NA	Director/D
B.8742	South	ROPAR	11KV	D5 DIVN. SAMRALA	KOHARA	8252FL13	Agri. Unit, Wansapati-11kv	AMR	OK	31.03.2023	Category 2				11116812	Not installed	9.656		NA	Director/D
B.8743	South	ROPAR	11KV	D5 DIVN. SAMRALA	KOHARA	8252FL21	Bhagwati-11KV	AMR	OK	31.03.2023	Category 2				6772589	400-200/5-5	9.872		NA	Director/D
B.8744	South	ROPAR	11KV	D5 DIVN. SAMRALA	KOHARA	8252FL26	11 KV NKH	AMR	OK	31.03.2023	Category 2				1273743	Not installed	9.997		NA	Director/D
B.8745	South	ROPAR	11KV	D5 DIVN. SAMRALA	KOHARA	8252FL09	11 KV United Ispat	AMR	OK	31.03.2023	Category 2				11116780	Not installed	10.693		NA	Director/D
B.8746	South	ROPAR	11KV	D5 DIVN. SAMRALA	KOHARA	C259FL21	Sahib alloy	AMR	OK	31.03.2023	Category 2				13190466	Not installed	11.298		NA	Director/D
B.8747	South	ROPAR	11KV	D5 DIVN. SAMRALA	KOHARA	8252FL25	Bioprocess Alloys-11KV	AMR	OK	31.03.2023	Category 2				30925	Not installed	11.406		NA	Director/D
B.8748	South	ROPAR	11KV	D5 DIVN. SAMRALA	KOHARA	8252FL20	11KV Mianji Steel	AMR	OK	31.03.2023	Category 2				5296198	400-200/5-5	12.656		NA	Director/D
B.8749	South	ROPAR	11KV	D5 DIVN. SAMRALA	KOHARA	8252FL16	11 KV Texas	AMR	OK	31.03.2023	Category 4				2067688	Not installed	14.609		NA	Director/D
B.8750	South	ROPAR	11KV	D5 DIVN. SAMRALA	KOHARA	8252FL10	11 KV Ishar Alloys	AMR	OK	31.03.2023	Category 2				5437504	Not installed	17.986		NA	Director/D
B.8751	South	ROPAR	11KV	D5 DIVN. SAMRALA	KOHARA	8252FL19	11 KV Jagron Metal	AMR	OK	31.03.2023	Category 2				9154452	Not installed	19.303		NA	Director/D
B.8752	South	ROPAR	11KV	D5 DIVN. SAMRALA	KOHARA	0277FL09	11 KV acme	AMR	OK	31.03.2023	Category 1				3959	900-450/577/1-1-1	0.797		NA	Director/D
B.8753	South	ROPAR	11KV	D5 DIVN. SAMRALA	KOHARA	0277FL05	Jindal	AMR	OK	31.03.2023	AP 3Phase 3Wire				318027	900-450/577/1-1-1	1.203		NA	Director/D
B.8754	South	ROPAR	11KV	D5 DIVN. SAMRALA	KOHARA	0277FL08	11 KV Gangotri Rubber	AMR	OK	31.03.2023	Category 2				3933	900-450/577/1-1-1	3.603		NA	Director/D
B.8755	South	ROPAR	11KV	D5 DIVN. SAMRALA	KOHARA	FL12D277	Hero Cycle	AMR	OK	31.03.2023	Category 4				12345	1800-900	4.252		NA	Director/D
B.8756	South	ROPAR	11KV	D5 DIVN. SAMRALA	KOHARA	0277FL01	11 KV Jandiali	NON AMR	OK	31.03.2023	Category 1				16199474	900-450/577/1-1-1	5.093		NA	Director/D
B.8757	South	ROPAR	11KV	D5 DIVN. SAMRALA	KOHARA	0277FL06	11KV AMWAY Forging	AMR	OK	31.03.2023	Category 2				12345	900-450/577/1-1-1	5.874		NA	Director/D
B.8758	South	ROPAR	11KV	D5 DIVN. SAMRALA	KOHARA	0277FL11	11 KV Budhewal Road	AMR	OK	31.03.2023	Category 2				1800-900	Not installed	6.001		NA	Director/D
B.8759	South	ROPAR	11KV	D5 DIVN. SAMRALA	KOHARA	0277FL10	11 KV Paharawal Road	NON AMR	OK	31.03.2023	Category 2				23456	1800-900	7.227		NA	Director/D
B.8760	South	ROPAR	11KV	D5 DIVN. SAMRALA	KOHARA	0277FL04	11 KV Jindal Agro	AMR	OK	31.03.2023	Category 2				16199453	900-450/577/1-1-1	9.319		NA	Director/D
B.8761	South	ROPAR	11KV	D5 DIVN. SAMRALA	KOHARA	0277FL02	11 KV Asian Lacto	NON AMR	OK	31.03.2023	Category 2				16199471	900-450/577/1-1-1	9.347		NA	Director/D
B.8762	South	ROPAR	11KV	D5 DIVN. SAMRALA	KOHARA	0277FL03	11 KV Osho tool	AMR	OK	31.03.2023	Category 2				16199454	900-450/577/1-1-1	15.911		NA	Director/D
B.8763	South	ROPAR	11KV	D5 DIVN. SAMRALA	KOHARA	0279FL04	Fatehgarh Jattan AP	AMR	OK	31.03.2023	AP 3Phase 3Wire				5250	1200-600/5	0.060		NA	Director/D
B.8764	South	ROPAR	11KV	D5 DIVN. SAMRALA	KOHARA	0279FL05	11KV Sahelwal Cat-2	AMR	OK	31.03.2023	Category 2				5337	1200-600/5	0.103		NA	Director/D
B.8765	South	ROPAR	11KV	D5 DIVN. SAMRALA	KOHARA	0279FL02	Marewal AP	AMR	OK	31.03.2023	AP 3Phase 3Wire				5372	1200-600/5	0.328		NA	Director/D
B.8766	South	ROPAR	11KV	D5 DIVN. SAMRALA	KOHARA	0279FL03	11KV Kalas Kalan UPS	AMR	OK	31.03.2023	Category 5 UPS				5389					

S.No	Zone	Circle	Voltage Level (kVA)	Division (kVA)	Sub-Division (kVA)	Feeder ID	Feeder Name	Feeder Metering Status (Metered/unmetered/AMR/AM)	Status of Meter (Functional/Non-functional)	Metering Date	% data received through automatically if feeder AMR/AM	Status of Communication		Period from 01.04.2021 to 31.03.2022				Sales	Remarks (Source of data)
												Total Number of hours in the period	Number of hours when meter was unable to communicate in overall	Meter S.No	CT/PT ratio	Import (MU)	Export (MU)		
B.8797	South	ROPAR	66KV	DS DIVN. SAMRALA	KOHARA	B25ZDL01	66 KV Alloyed Recycling	AMR	OK	31.03.2023	Category 3			Not available	Not available	199.080	NA	Director/D	
B.8798	South	ROPAR	11KV	DS DIVN. SAMRALA	MACHHIWARA	D26ZF126	11 KV Rattipur	NON AMR	OK	31.03.2023	AP 3Phase 3WIrre			4187129	1200-600/5	1.305	NA	Director/D	
B.8799	South	ROPAR	11KV	DS DIVN. SAMRALA	MACHHIWARA	D26ZF09	Sub station Transformer heddon	AMR	OK	31.03.2023	Substation Transformer			12265	900-450/577/1-1-1	0.021	NA	Director/D	
B.8800	South	ROPAR	11KV	DS DIVN. SAMRALA	MACHHIWARA	D26ZF11	11 KV SHERAN UPS	AMR	OK	31.03.2023	Category 5-UPS			8223802	1200-600/5	0.078	NA	Director/D	
B.8801	South	ROPAR	11KV	DS DIVN. SAMRALA	MACHHIWARA	D26ZF10	Mubarakpur	AMR	OK	31.03.2023	AP 3Phase 3WIrre			11069767	1200-600/5	0.867	NA	Director/D	
B.8802	South	ROPAR	11KV	DS DIVN. SAMRALA	MACHHIWARA	D26ZF02	11 KV Kotala Bet	AMR	OK	31.03.2023	AP 3Phase 3WIrre			9140842	900-450/577/1-1-1	0.979	NA	Director/D	
B.8803	South	ROPAR	11KV	DS DIVN. SAMRALA	MACHHIWARA	D26ZF04	11 KV Akalgah	AMR	OK	31.03.2023	AP 3Phase 3WIrre			8222646	900-450/577/1-1-1	1.085	NA	Director/D	
B.8804	South	ROPAR	11KV	DS DIVN. SAMRALA	MACHHIWARA	D26ZF125	Guga Marr	NON AMR	OK	31.03.2023	Category 1			36799	900-450/577/1-1-1	1.343	NA	Director/D	
B.8805	South	ROPAR	11KV	DS DIVN. SAMRALA	MACHHIWARA	D26ZF08	Tandi	AMR	OK	31.03.2023	AP 3Phase 3WIrre			1234	1200-600/5	1.836	NA	Director/D	
B.8806	South	ROPAR	11KV	DS DIVN. SAMRALA	MACHHIWARA	D26ZF03	11 KV Sakinderpur	AMR	OK	31.03.2023	AP 3Phase 3WIrre			7042924	900-450/577/1-1-1	2.652	NA	Director/D	
B.8807	South	ROPAR	11KV	DS DIVN. SAMRALA	MACHHIWARA	D26ZF01	11 KV Headdon Bet	NON AMR	OK	31.03.2023	Category 5-UPS			7336438	900-450/577/1-1-1	4.122	NA	Director/D	
B.8808	South	ROPAR	11KV	DS DIVN. SAMRALA	MACHHIWARA	D26ZF07	11 KV BARSAL KALAN	AMR	OK	31.03.2023	Category 5-UPS			123456	900-450/577/1-1-1	7.735	NA	Director/D	
B.8809	South	ROPAR	11KV	DS DIVN. SAMRALA	MACHHIWARA	D26ZF131	SUB STATION TRANSFORMER	AMR	OK	31.03.2023	Substation Transformer			4158	1200/577/1-1-1	0.010	NA	Director/D	
B.8810	South	ROPAR	11KV	DS DIVN. SAMRALA	MACHHIWARA	D26ZF02	11 KV Garh Bet	AMR	OK	31.03.2023	AP 3Phase 3WIrre			8223837	1200/577/1-1-1	0.616	NA	Director/D	
B.8811	South	ROPAR	11KV	DS DIVN. SAMRALA	MACHHIWARA	D26ZF11	11 KV Shergarh	AMR	OK	31.03.2023	AP 3Phase 3WIrre			6740948	1200/577/1-1-1	0.719	NA	Director/D	
B.8812	South	ROPAR	11KV	DS DIVN. SAMRALA	MACHHIWARA	D26ZF132	11 KV MNEWAL	AMR	OK	31.03.2023	AP 3Phase 3WIrre			73191414	1200/577/1-1-1	0.888	NA	Director/D	
B.8813	South	ROPAR	11KV	DS DIVN. SAMRALA	MACHHIWARA	D26ZF120	11 KV Rajgarh	AMR	OK	31.03.2023	AP 3Phase 3WIrre			8222542	1200/577/1-1-1	1.167	NA	Director/D	
B.8814	South	ROPAR	11KV	DS DIVN. SAMRALA	MACHHIWARA	D26ZF04	11 KV Ihaar Sahib	AMR	OK	31.03.2023	AP 3Phase 3WIrre			5341561	1200/577/1-1-1	1.299	NA	Director/D	
B.8815	South	ROPAR	11KV	DS DIVN. SAMRALA	MACHHIWARA	D26ZF121	Noorpur	NON AMR	OK	31.03.2023	AP 3Phase 3WIrre			13190572	900-450/577/1-1-1	1.313	NA	Director/D	
B.8816	South	ROPAR	11KV	DS DIVN. SAMRALA	MACHHIWARA	D26ZF13	11 KV Bhithan	AMR	OK	31.03.2023	Category 5-UPS			8222542	900-450/577/1-1-1	1.708	NA	Director/D	
B.8817	South	ROPAR	11KV	DS DIVN. SAMRALA	MACHHIWARA	D26ZF113	11 KV Jassowal	NON AMR	OK	31.03.2023	AP 3Phase 3WIrre			5027218	1200/577/1-1-1	1.948	NA	Director/D	
B.8818	South	ROPAR	11KV	DS DIVN. SAMRALA	MACHHIWARA	D26ZF09	11 KV Ghumana	AMR	OK	31.03.2023	AP 3Phase 3WIrre			6740948	900-450/577/1-1-1	2.021	NA	Director/D	
B.8819	South	ROPAR	11KV	DS DIVN. SAMRALA	MACHHIWARA	D26ZF01	11 KV Lubangarh	AMR	OK	31.03.2023	AP 3Phase 3WIrre			2067360	1200/577/1-1-1	2.262	NA	Director/D	
B.8820	South	ROPAR	11KV	DS DIVN. SAMRALA	MACHHIWARA	D26ZF119	11 KV Ahuja Cotspin	AMR	OK	31.03.2023	Category 4			7030193	900-450/577/1-1-1	2.515	NA	Director/D	
B.8821	South	ROPAR	11KV	DS DIVN. SAMRALA	MACHHIWARA	D26ZF129	Uma	AMR	OK	31.03.2023	Category 5-UPS			7193536	1200/577/1-1-1	2.643	NA	Director/D	
B.8822	South	ROPAR	11KV	DS DIVN. SAMRALA	MACHHIWARA	D26ZF12	11 KV Cotspin 2	AMR	OK	31.03.2023	Category 5-UPS			32392	900-450/577/1-1-1	3.581	NA	Director/D	
B.8823	South	ROPAR	11KV	DS DIVN. SAMRALA	MACHHIWARA	D26ZF127	11KV AODIANA	AMR	OK	31.03.2023	Category 5-UPS			3237	1200/577/1-1-1	4.076	NA	Director/D	
B.8824	South	ROPAR	11KV	DS DIVN. SAMRALA	MACHHIWARA	D26ZF08	11 KV Garg Concast	AMR	OK	31.03.2023	Category 2			9154380	1200/577/1-1-1	4.555	NA	Director/D	
B.8825	South	ROPAR	11KV	DS DIVN. SAMRALA	MACHHIWARA	D26ZF10	11 KV Markfed	AMR	OK	31.03.2023	Category 1			5437730	1200/577/1-1-1	4.715	NA	Director/D	
B.8826	South	ROPAR	11KV	DS DIVN. SAMRALA	MACHHIWARA	D26ZF123	Charan kamwal sahib	AMR	OK	31.03.2023	Category 1			15196799	1200/577/1-1-1	5.602	NA	Director/D	
B.8827	South	ROPAR	11KV	DS DIVN. SAMRALA	MACHHIWARA	D26ZF128	Uthawal kalan	AMR	OK	31.03.2023	Category 5-UPS			3598	1200/577/1-1-1	6.080	NA	Director/D	
B.8828	South	ROPAR	11KV	DS DIVN. SAMRALA	MACHHIWARA	D26ZF16	11 KV Chakri Rasal	AMR	OK	31.03.2023	Category 5-UPS			5489732	900-450/577/1-1-1	7.464	NA	Director/D	
B.8829	South	ROPAR	11KV	DS DIVN. SAMRALA	MACHHIWARA	D26ZF15	11 KV Machiwara	AMR	OK	31.03.2023	Category 1			2068123	900-450/577/1-1-1	10.344	NA	Director/D	
B.8830	South	ROPAR	11KV	DS DIVN. SAMRALA	MACHHIWARA	D26ZF14	11 KV Methewal	AMR	OK	31.03.2023	Category 5-UPS			5295557	1200/577/1-1-1	10.379	NA	Director/D	
B.8831	South	ROPAR	11KV	DS DIVN. SAMRALA	MACHHIWARA	D26ZF130	Gani Khan Nahi Khan	AMR	OK	31.03.2023	Category 1			36747	900-450/577/1-1-1	10.385	NA	Director/D	
B.8832	South	ROPAR	11KV	DS DIVN. SAMRALA	MACHHIWARA	D26ZF05	11 KV Bindra Ispat	Not available	OK	31.03.2023	Category 2			5341681	1200/577/1-1-1	12.707	NA	Director/D	
B.8833	South	ROPAR	66KV	DS DIVN. SAMRALA	MACHHIWARA	D26ZF17	66 KV Adhunik Alloys	Not available	OK	31.03.2023	Category 3			Not available	Not available	8.736	NA	Director/D	
B.8834	South	ROPAR	66KV	DS DIVN. SAMRALA	MACHHIWARA	D14DQ101	66 KV Malwa	Not available	OK	31.03.2023	Category 4			Not available	Not available	25.504	NA	Director/D	
B.8835	South	ROPAR	66KV	DS DIVN. SAMRALA	MACHHIWARA	D258DL18	66 KV Shiva Tax Feb	Not available	OK	31.03.2023	Category 4			Not available	Not available	52.105	NA	Director/D	
B.8836	South	ROPAR	66KV	DS DIVN. SAMRALA	MACHHIWARA	D14DQ102	66 KV S.T. Cotex	OK	31.03.2023	Category 4				Not available	Not available	152.842	NA	Director/D	
B.8837	South	SANGRUR	11KV	DS CITY DIVN. SUNAM	DS CITY S/D SUNAM	B204FL99	SUB STATION TR2	AMR	OK	31.03.2023	Substation Transformer			72	900-450/5	0.045	NA	Director/D	
B.8838	South	SANGRUR	11KV	DS CITY DIVN. SUNAM	DS CITY S/D SUNAM	B204FL98	SUB STATION TR1	AMR	OK	31.03.2023	Substation Transformer			3342432	1200-600/5	0.059	NA	Director/D	
B.8839	South	SANGRUR	11KV	DS CITY DIVN. SUNAM	DS CITY S/D SUNAM	B204FL12	11 KV HOSPITAL ROAD LINE	AMR	OK	31.03.2023	Category 5			8220267	900-450/5	0.185	NA	Director/D	
B.8840	South	SANGRUR	11KV	DS CITY DIVN. SUNAM	DS CITY S/D SUNAM	B20442	11KV SATOPEER	AMR	OK	31.03.2023	AP 3Phase 3WIrre			4589	900-450/5	1.591	NA	Director/D	
B.8841	South	SANGRUR	11KV	DS CITY DIVN. SUNAM	DS CITY S/D SUNAM	B204FL09	11 KV DADI POTI AP	AMR	OK	31.03.2023	AP 3Phase 3WIrre			10288305	900-450/5	1.806	NA	Director/D	
B.8842	South	SANGRUR	11KV	DS CITY DIVN. SUNAM	DS CITY S/D SUNAM	B204FL04	11 KV NAMOL ROAD AP	AMR	OK	31.03.2023	AP 3Phase 3WIrre			10282998	900-450/5	1.984	NA	Director/D	
B.8843	South	SANGRUR	11KV	DS CITY DIVN. SUNAM	DS CITY S/D SUNAM	B204FL03	11 KV LAKHMIWALA AP	AMR	OK	31.03.2023	AP 3Phase 3WIrre			1223367	1200-600/5	1.987	NA	Director/D	
B.8844	South	SANGRUR	11KV	DS CITY DIVN. SUNAM	DS CITY S/D SUNAM	B204FL05	11 KV BATHINDA ROAD AP	AMR	OK	31.03.2023	AP 3Phase 3WIrre			5226386	1200-600/5	2.008	NA	Director/D	
B.8845	South	SANGRUR	11KV	DS CITY DIVN. SUNAM	DS CITY S/D SUNAM	B204FL10	11 KV SINGHPURA AP	AMR	OK	31.03.2023	AP 3Phase 3WIrre			2067767	1200-600/5	2.377	NA	Director/D	
B.8846	South	SANGRUR	11KV	DS CITY DIVN. SUNAM	DS CITY S/D SUNAM	B204FL11	11 KV SHERON ROAD AP	AMR	OK	31.03.2023	AP 3Phase 3WIrre			82	900-450/5	2.908	NA	Director/D	
B.8847	South	SANGRUR	11KV	DS CITY DIVN. SUNAM	DS CITY S/D SUNAM	B204FL08	11 KV BHARUP AP	AMR	OK	31.03.2023	AP 3Phase 3WIrre			83	900-450/5	3.002	NA	Director/D	
B.8848	South	SANGRUR	11KV	DS CITY DIVN. SUNAM	DS CITY S/D SUNAM	B204FL13	11 KV ELAHI CHOWK URBAN	AMR	OK	31.03.2023	Category 1			579613	900-450/5	3.038	NA	Director/D	
B.8849	South	SANGRUR	11KV	DS CITY DIVN. SUNAM	DS CITY S/D SUNAM	B204FL01	11 KV SITARGH URBAN	AMR	OK	31.03.2023	Category 1			9154288	900-450/5	12.734	NA	Director/D	
B.8850	South	SANGRUR	11KV	DS CITY DIVN. SUNAM	DS CITY S/D SUNAM	B204FL02	11 KV HOSPITAL ROAD URBAN	AMR	OK	31.03.2023	Category 1			2067803	1200-600/5	13.529	NA	Director/D	
B.8851	South	SANGRUR	11KV	DS CITY DIVN. SUNAM	DS CITY S/D SUNAM	X23BF101	11 KV LACHMANPURA AP	AMR	OK	31.03.2023	AP 3Phase 3WIrre			43234	600/577/1-1-1	0.883	NA	Director/D	
B.8852	South	SANGRUR	11KV	DS CITY DIVN. SUNAM	DS CITY S/D SUNAM	X23BF102	11 KV BHAGWANPURA ROAD AP	AMR	OK	31.03.2023	AP 3Phase 3WIrre			36960	600/577/1-1-1	2.130	NA	Director/D	
B.8853	South	SANGRUR	11KV	DS CITY DIVN. SUNAM	DS CITY S/D SUNAM	D22ZF116	11 KV COURT COMPLEX URBAN	AMR	OK	31.03.2023	Category 1			579611	1200/577/1-1-1	0.093	NA	Director/D	
B.8854	South	SANGRUR	11KV	DS CITY DIVN. SUNAM	DS CITY S/D SUNAM	D22ZF114	11 KV CITY SUNAM URBAN	AMR	OK	31.03.2023	Category 1			2066468	1200-600/5	0.884	NA	Director/D	
B.8855	South	SANGRUR	11KV	DS CITY DIVN. SUNAM	DS CITY S/D SUNAM	D22ZF112	11 KV SAHIB DHARMA SINGH URBAN	AMR	OK	31.03.2023	Category 1			79197	1200/577/1-1-1	10.403	NA	Director/D	
B.8856	South	SANGRUR	11KV	DS CITY DIVN. SUNAM	DS CITY S/D SUNAM	D22ZF119	11 KV NEW ANAJ MANDI URBAN	NON AMR	OK	31.03.2023	Category 1			579584	1200/577/1-1-1	11.658	NA	Director/D	
B.8857	South	SANGRUR																	

S.No	Zone	Circle	Voltage (kVA)	Division (kVA)	Sub-Division (kVA)	Feeder ID	Feeder Name	Feeder Metering Status (Metered/unmetered/AMR/AMI)	Status of Meter (Functional/Non-Functional)	Metering Date (Date of last actual meter reading/communication)	Feeder Type (Agr/Industrial/Mixed)	Status of Communication			Period from 01.04.2021 to 31.03.2022				Sales	Remarks (Source of data)
												% data received through automatically if feeder AMR/AMI	Number of hours when meter was unable to communicate in overall	Total Number of hours in the period	Meter S.No	CT/PT ratio	Import (kU)	Export (kU)		
B.8894	South	SANGRUR	11KV	DS CITY DIVN. SUNAM	DS S/D CHEEMA	0224FL02	11 KV DHARAMGARH AP	AMR	OK	31.03.2023	AP 3Phase 3Wire				8223040	900-450/5	0.367	NA	Director/D	
B.8895	South	SANGRUR	11KV	DS CITY DIVN. SUNAM	DS S/D CHEEMA	0224FL22	11 KV MODEL TOWN AP(CHEEMA GRID)	AMR	OK	31.03.2023	AP 3Phase 3Wire				44915	900-450/5	0.810	NA	Director/D	
B.8896	South	SANGRUR	11KV	DS CITY DIVN. SUNAM	DS S/D CHEEMA	0224FL18	11 KV KUTIA AP	AMR	OK	31.03.2023	AP 3Phase 3Wire				15194760	900-450/5	1.156	NA	Director/D	
B.8897	South	SANGRUR	11KV	DS CITY DIVN. SUNAM	DS S/D CHEEMA	0224FL18	BHAI BHELO	AMR	OK	31.03.2023	AP 3Phase 3Wire				4356	900-450/5	1.237	NA	Director/D	
B.8898	South	SANGRUR	11KV	DS CITY DIVN. SUNAM	DS S/D CHEEMA	0224FL08	11 KV HEERO KALAN AP	AMR	OK	31.03.2023	AP 3Phase 3Wire				5437692	900-450/5	1.523	NA	Director/D	
B.8899	South	SANGRUR	11KV	DS CITY DIVN. SUNAM	DS S/D CHEEMA	0224FL19	11 KV MAN PATI AP	AMR	OK	31.03.2023	AP 3Phase 3Wire				15194779	1200-600/5	1.620	NA	Director/D	
B.8900	South	SANGRUR	11KV	DS CITY DIVN. SUNAM	DS S/D CHEEMA	0224FL04	11 KV CHOW BAS AP	AMR	OK	31.03.2023	AP 3Phase 3Wire				15193904	900-450/5	1.826	NA	Director/D	
B.8901	South	SANGRUR	11KV	DS CITY DIVN. SUNAM	DS S/D CHEEMA	0224FL07	11 KV JARHEPA AP	AMR	OK	31.03.2023	Category 5-UPS				5437683	900-450/5	1.853	NA	Director/D	
B.8902	South	SANGRUR	11KV	DS CITY DIVN. SUNAM	DS S/D CHEEMA	0224FL12	11 KV SAHUR AP(CHEEMA GRID)	AMR	OK	31.03.2023	AP 3Phase 3Wire				2064382	900-450/5	1.863	NA	Director/D	
B.8903	South	SANGRUR	11KV	DS CITY DIVN. SUNAM	DS S/D CHEEMA	0224FL27	11 KV Rohi AP, Cheema Grid	AMR	OK	31.03.2023	AP 3Phase 3Wire				3633	900-450/5	1.877	NA	Director/D	
B.8904	South	SANGRUR	11KV	DS CITY DIVN. SUNAM	DS S/D CHEEMA	0224FL11	11 KV AMRUKOTRA AP	AMR	OK	31.03.2023	AP 3Phase 3Wire				15194862	900-450/5	1.930	NA	Director/D	
B.8905	South	SANGRUR	11KV	DS CITY DIVN. SUNAM	DS S/D CHEEMA	0224FL21	11 KV BOOR AP	AMR	OK	31.03.2023	AP 3Phase 3Wire				44916	900-450/5	2.055	NA	Director/D	
B.8906	South	SANGRUR	11KV	DS CITY DIVN. SUNAM	DS S/D CHEEMA	0224FL03	11 KV SUNAM ROAD (CHEEMA GRID)	AMR	OK	31.03.2023	AP 3Phase 3Wire				5463611	900-450/5	2.159	NA	Director/D	
B.8907	South	SANGRUR	11KV	DS CITY DIVN. SUNAM	DS S/D CHEEMA	0224FL14	11 KV BIR KALAN AP	AMR	OK	31.03.2023	AP 3Phase 3Wire				8223036	1200-600/5	2.165	NA	Director/D	
B.8908	South	SANGRUR	11KV	DS CITY DIVN. SUNAM	DS S/D CHEEMA	0224FL01	11 KV TOLWAL AP	AMR	OK	31.03.2023	AP 3Phase 3Wire				8223543	1200-600/5	2.177	NA	Director/D	
B.8909	South	SANGRUR	11KV	DS CITY DIVN. SUNAM	DS S/D CHEEMA	0224FL15	11 KV BABA RODI RAM AP	AMR	OK	31.03.2023	AP 3Phase 3Wire				8222545	900-450/5	2.313	NA	Director/D	
B.8910	South	SANGRUR	11KV	DS CITY DIVN. SUNAM	DS S/D CHEEMA	0224FL05	11 KV SATOJ AP	AMR	OK	31.03.2023	AP 3Phase 3Wire				33473	900-450/5	2.346	NA	Director/D	
B.8911	South	SANGRUR	11KV	DS CITY DIVN. SUNAM	DS S/D CHEEMA	0224FL20	11 KV BEEBH AP	AMR	OK	31.03.2023	AP 3Phase 3Wire				15194738	900-450/5	2.582	NA	Director/D	
B.8912	South	SANGRUR	11KV	DS CITY DIVN. SUNAM	DS S/D CHEEMA	0224FL17	11 KV BABA KARMA AP	AMR	OK	31.03.2023	AP 3Phase 3Wire				15194801	1200-600/5	2.715	NA	Director/D	
B.8913	South	SANGRUR	11KV	DS CITY DIVN. SUNAM	DS S/D CHEEMA	0224FL25	11 KV Togaal Ap	AMR	OK	31.03.2023	AP 3Phase 3Wire				4568	1200-600/5	2.823	NA	Director/D	
B.8914	South	SANGRUR	11KV	DS CITY DIVN. SUNAM	DS S/D CHEEMA	0224FL10	11 KV JARHEPA AP(CHEEMA GRID)	AMR	OK	31.03.2023	AP 3Phase 3Wire				8223037	1200-600/5	2.839	NA	Director/D	
B.8915	South	SANGRUR	11KV	DS CITY DIVN. SUNAM	DS S/D CHEEMA	0224FL09	11 KV HARON AP	AMR	OK	31.03.2023	AP 3Phase 3Wire				8223038	1200-600/5	3.267	NA	Director/D	
B.8916	South	SANGRUR	11KV	DS CITY DIVN. SUNAM	DS S/D CHEEMA	0224FL23	11 KV SAMADHAN URBAN	AMR	OK	31.03.2023	Category 1				15194806	900-450/5	8.138	NA	Director/D	
B.8917	South	SANGRUR	11KV	DS CITY DIVN. SUNAM	DS S/D CHEEMA	0224FL24	Pindian Ups	AMR	OK	31.03.2023	Category 5-UPS				3420	900-450/5	8.333	NA	Director/D	
B.8918	South	SANGRUR	11KV	DS CITY DIVN. SUNAM	DS S/D CHEEMA	0224FL13	11 KV HEERO KALAN UPS	AMR	OK	31.03.2023	Category 5-UPS				2064448	1200-600/5	10.623	NA	Director/D	
B.8919	South	SANGRUR	11KV	DS CITY DIVN. SUNAM	DS S/D CHEEMA	0224FL06	11 KV CHEEMA URBAN	AMR	OK	31.03.2023	Category 3				8223092	1200-600/5	11.286	NA	Director/D	
B.8920	South	SANGRUR	11KV	DS CITY DIVN. SUNAM	DS S/D CHEEMA	0248FL06	11KV KHAWA KHURD AP	AMR	OK	31.03.2023	AP 3Phase 3Wire				9140928	900-450/5/7/1-1	1.188	NA	Director/D	
B.8921	South	SANGRUR	11KV	DS CITY DIVN. SUNAM	DS S/D CHEEMA	B248FL12	HEERON KALAN AP	AMR	OK	31.03.2023	AP 3Phase 3Wire				5647	900-450/5	1.255	NA	Director/D	
B.8922	South	SANGRUR	11KV	DS CITY DIVN. SUNAM	DS S/D CHEEMA	0248FL01	11 KV TOGAWAL AP	AMR	OK	31.03.2023	AP 3Phase 3Wire				9140930	900-450/5	2.502	NA	Director/D	
B.8923	South	SANGRUR	11KV	DS CITY DIVN. SUNAM	DS S/D CHEEMA	0248FL08	11KV UPS TOGAWAL	NON AMR	OK	31.03.2023	Category 5-UPS				2760	900-450/5	3.850	NA	Director/D	
B.8924	South	SANGRUR	11KV	DS CITY DIVN. SUNAM	DS S/D CHEEMA	0223FL99	SUB STATION TRANSFORMER KANKWAL	AMR	OK	31.03.2023	Substation Transformer				726703	900-450/5	0.024	NA	Director/D	
B.8925	South	SANGRUR	11KV	DS CITY DIVN. SUNAM	DS S/D CHEEMA	0248FL08	11 KV KANAKWAL URBAN	AMR	OK	31.03.2023	AP 3Phase 3Wire				9140915	900-450/5	1.264	NA	Director/D	
B.8926	South	SANGRUR	11KV	DS CITY DIVN. SUNAM	DS S/D CHEEMA	0225FL11	11 KV GANDUA RURAL	AMR	OK	31.03.2023	AP 3Phase 3Wire				10281304	1200-600/5	1.362	NA	Director/D	
B.8927	South	SANGRUR	11KV	DS CITY DIVN. SUNAM	DS S/D CHEEMA	0225FL06	11 KV HUMBLEWAS AP	AMR	OK	31.03.2023	AP 3Phase 3Wire				10281300	1200-600/5	1.542	NA	Director/D	
B.8928	South	SANGRUR	11KV	DS CITY DIVN. SUNAM	DS S/D CHEEMA	0225FL16	11 KV BABA Mukand Dass AP	AMR	OK	31.03.2023	AP 3Phase 3Wire				3137	1200-600/5	1.643	NA	Director/D	
B.8929	South	SANGRUR	11KV	DS CITY DIVN. SUNAM	DS S/D CHEEMA	0225FL09	11 KV JARHAL RURAL	AMR	OK	31.03.2023	AP 3Phase 3Wire				9140913	1200-600/5	2.021	NA	Director/D	
B.8930	South	SANGRUR	11KV	DS CITY DIVN. SUNAM	DS S/D CHEEMA	0225FL02	11 KV SOOLA SINGH WALA AP	AMR	OK	31.03.2023	AP 3Phase 3Wire				8223465	1200-600/5	2.438	NA	Director/D	
B.8931	South	SANGRUR	11KV	DS CITY DIVN. SUNAM	DS S/D CHEEMA	0225FL01	11 KV RATTANGARH AP	AMR	OK	31.03.2023	AP 3Phase 3Wire				9140911	1200-600/5	3.057	NA	Director/D	
B.8932	South	SANGRUR	11KV	DS CITY DIVN. SUNAM	DS S/D CHEEMA	0225FL12	11 KV DHARGARH UPS	AMR	OK	31.03.2023	Category 5-UPS				15194780	900-450/5	3.293	NA	Director/D	
B.8933	South	SANGRUR	11KV	DS CITY DIVN. SUNAM	DS S/D CHEEMA	0225FL04	11 KV KANAKWAL URBAN	AMR	OK	31.03.2023	Category 1				6675545	900-450/5	3.386	NA	Director/D	
B.8934	South	SANGRUR	11KV	DS CITY DIVN. SUNAM	DS S/D LONGOWAL	X219FL20	UPS KUNNRAN	OK	31.03.2023	Category 5-UPS				3613	1200-600/5	1.965	NA	Director/D		
B.8935	South	SANGRUR	11KV	DS CITY DIVN. SUNAM	DS S/D LONGOWAL	X219FL09	11 KV KUNRA AP(DUGGAN GRID)	NON AMR	OK	31.03.2023	AP 3Phase 3Wire				15194847	1200-600/5	2.496	NA	Director/D	
B.8936	South	SANGRUR	11KV	DS CITY DIVN. SUNAM	DS S/D LONGOWAL	X230FL99	SUB STATION TRANSFORMER LOHAKHERA	AMR	OK	31.03.2023	Substation Transformer				1180581	Not installed	0.018	NA	Director/D	
B.8937	South	SANGRUR	11KV	DS CITY DIVN. SUNAM	DS S/D LONGOWAL	X230FL03	11 KV MANDER KHURD AP	AMR	OK	31.03.2023	AP 3Phase 3Wire				15193735	Not installed	1.355	NA	Director/D	
B.8938	South	SANGRUR	11KV	DS CITY DIVN. SUNAM	DS S/D LONGOWAL	X230FL09	Pindian Road	AMR	OK	31.03.2023	AP 3Phase 3Wire				2803	Not installed	2.182	NA	Director/D	
B.8939	South	SANGRUR	11KV	DS CITY DIVN. SUNAM	DS S/D LONGOWAL	X230FL06	11 KV MANDER KALAN AP	AMR	OK	31.03.2023	AP 3Phase 3Wire				43117	Not installed	2.370	NA	Director/D	
B.8940	South	SANGRUR	11KV	DS CITY DIVN. SUNAM	DS S/D LONGOWAL	X230FL08	BUGRAN UPS	AMR	OK	31.03.2023	Category 5-UPS				2730	Not installed	2.427	NA	Director/D	
B.8941	South	SANGRUR	11KV	DS CITY DIVN. SUNAM	DS S/D LONGOWAL	X230FL04	11 KV ASRA KALAN AP	AMR	OK	31.03.2023	AP 3Phase 3Wire				28782	Not installed	2.828	NA	Director/D	
B.8942	South	SANGRUR	11KV	DS CITY DIVN. SUNAM	DS S/D LONGOWAL	X230FL01	11 KV LOHAKHERA URBAN C1	AMR	OK	31.03.2023	Category 1				43134	Not installed	2.893	NA	Director/D	
B.8943	South	SANGRUR	11KV	DS CITY DIVN. SUNAM	DS S/D LONGOWAL	X230FL02	11 KV PEERKHA ROAD AP	AMR	OK	31.03.2023	AP 3Phase 3Wire				15193734	Not installed	2.921	NA	Director/D	
B.8944	South	SANGRUR	11KV	DS CITY DIVN. SUNAM	DS S/D LONGOWAL	X230FL05	11 KV LONGOWAL ROAD AP(LOHAKHER)	NON AMR	OK	31.03.2023	AP 3Phase 3Wire				43216	Not installed	3.074	NA	Director/D	
B.8945	South	SANGRUR	11KV	DS CITY DIVN. SUNAM	DS S/D LONGOWAL	0248FL99	SUB STATION TRANSFORMER DHADRAN	AMR	OK	31.03.2023	Substation Transformer				800820	900-450/5	0.024	NA	Director/D	
B.8946	South	SANGRUR	11KV	DS CITY DIVN. SUNAM	DS S/D LONGOWAL	0248FL04	11 KV TAKPUR AP	AMR	OK	31.03.2023	AP 3Phase 3Wire				9140929	900-450/5	1.566	NA	Director/D	
B.8947	South	SANGRUR	11KV	DS CITY DIVN. SUNAM	DS S/D LONGOWAL	0248FL07	11 KV DIALGARH AP	AMR	OK	31.03.2023	AP 3Phase 3Wire				314398	900-450/5	1.743	NA	Director/D	
B.8948	South	SANGRUR	11KV	DS CITY DIVN. SUNAM	DS S/D LONGOWAL	0248FL13	Rakoke	AMR	OK	31.03.2023	AP 3Phase 3Wire				5609	900-450/5	2.041	NA	Director/D	
B.8949	South	SANGRUR	11KV	DS CITY DIVN. SUNAM	DS S/D LONGOWAL	0248FL10	BABA MITHU SHAH	AMR	OK	31.03.2023	AP 3Phase 3Wire				16198489	900-450/5/7/1-1	2.285	NA	Director/D	
B.8950	South	SANGRUR	11KV	DS CITY DIVN. SUNAM	DS S/D LONGOWAL	0248FL11	Tibian Wali	AMR	OK	31.03.2023	AP 3Phase 3Wire				33398	900-450/5/7/1-1	3.016	NA	Director/D	
B.8951	South	SANGRUR	11KV	DS CITY DIVN. SUNAM	DS S/D LONGOWAL	0248FL03	11 KV DHADRAN URBAN	AMR	OK	31.03.2023	Category 1				6489723	900-450/5	3.083	NA	Director/D	
B.8952	South	SANGRUR	11KV	DS CITY DIVN. SUNAM	DS S/D LONGOWAL	0248FL02	11 KV BUGRAN AP	AMR	OK	31.03.2023	AP 3Phase 3Wire				6073695	900-450/5	4.631	NA	Director/D	
B.8953	South	SANGRUR	11KV	DS CITY DIVN. SUNAM	DS S/D LONGOWAL	0248FL09	DYALGARH	NON AMR	OK	31.03.2023	Category 5-UPS				16198444	900-450/5/7/1-1	5.476	NA	Director/D	
B.8954	South	SANGRUR	11KV	DS CITY DIVN. SUNAM	DS S/D LONGOWAL	0227FL99	SUB STATION TRANSFORMER LONGOWAL	AMR	OK	31.03.2023	Substation Transformer				10339141	1200-600/5	0.035	NA	Director/D	
B.8955	South	SANGRUR	11KV	DS CITY DIVN. SUNAM	DS S/D LONGOWAL	0227FL16	SAMADHA WALI BRANCH	AMR	OK	31.03.2023	AP 3Phase 3Wire				4822	1200-600/5	0.997	NA	Director/D	
B.8956	South	SANGRUR	11KV	DS CITY DIVN. SUNAM	DS S/D LONGOWAL	0227FL17	SHAPUR 2 NO.	AMR	OK	31.03.2023	AP 3Phase 3Wire				5347	1200-600/5	1.418	NA	Director/D	
B.8957	South	SANGRUR	11KV	DS CITY DIVN. SUNAM	DS S/D LONGOWAL	0227FL09	11 KV NAMOL AP(LONGOWAL GRID)	AMR	OK	31.03.2023	AP 3Phase 3Wire				2064458	1200-600/5	1.913	NA	Director/D	
B.8958	South	SANGRUR	11KV	DS CITY DIVN. SUNAM	DS S/D LONGOWAL	0227FL10	11 KV SAHUR AP	AMR	OK	31.03.2023	AP 3Phase 3Wire				2046618	1200-600/5	2.125	NA	Director/D	
B.8959	South	SANGRUR	11KV	DS CITY DIVN. SUNAM	DS S/D LONGOWAL	0														

S.No	Zone	Circle	Voltage Level (kVA)	Division (kVA)	Sub-Division (kVA)	Feeder ID	Feeder Name	Feeder Metering Status (Metered/unmetered/AMR/AMI)	Status of Meter (Functional/Non-Functional)	Metering Date (Date of last actual meter reading/communication)	Feeder Type (Agr./Industrial/Mixed)	Status of Communication				Period from 01.04.2021 to 31.03.2022				Sales	Remarks (Source of data)
												% data received through automatically if feeder AMR/AMI	Number of hours when meter was unable to communicate in overall	Total Number of hours in the period	Meter S.No	CT/PT ratio	Import (kWh)	Export (kWh)			
B.8991	South	SANGRUR	11KV	DS CITY DIVN. SUNAM	DS S/D UBHEWAL	0227FL14	11 KV BAHADURPUR UPS	NON AMR	OK	31.03.2023	Category 5-UPS				2068400	1200-600/5	5.454	NA	Director/D		
B.8992	South	SANGRUR	11KV	DS CITY DIVN. SUNAM	DS S/D UBHEWAL	0226FL99	SUB STATION TRANSFORMER UBHEWAL	AMR	OK	31.03.2023	Substation Transformer				86653	1200-600/5	0.025	NA	Director/D		
B.8993	South	SANGRUR	11KV	DS CITY DIVN. SUNAM	DS S/D UBHEWAL	0226FL13	11 KV JANDIANWALA AP	AMR	OK	31.03.2023	AP 3Phase 3Wire				1519608	900-450/5	1.673	NA	Director/D		
B.8994	South	SANGRUR	11KV	DS CITY DIVN. SUNAM	DS S/D UBHEWAL	0226FL01	11 KV SUNAM ROAD (BIBHAWA GRID)	AMR	OK	31.03.2023	AP 3Phase 3Wire				8223867	1200-600/5	1.933	NA	Director/D		
B.8995	South	SANGRUR	11KV	DS CITY DIVN. SUNAM	DS S/D UBHEWAL	0226FL05	11KV BAHADURPUR AP(UBHEWAL GRID)	AMR	OK	31.03.2023	AP 3Phase 3Wire				9141065	1200-600/5	1.948	NA	Director/D		
B.8996	South	SANGRUR	11KV	DS CITY DIVN. SUNAM	DS S/D UBHEWAL	0226FL08	11 KV BHAMABADI AP	AMR	OK	31.03.2023	AP 3Phase 3Wire				2059564	900-450/5	2.143	NA	Director/D		
B.8997	South	SANGRUR	11KV	DS CITY DIVN. SUNAM	DS S/D UBHEWAL	0226FL09	11 KV NAMOL AP	AMR	OK	31.03.2023	AP 3Phase 3Wire				2068895	900-450/5	2.377	NA	Director/D		
B.8998	South	SANGRUR	11KV	DS CITY DIVN. SUNAM	DS S/D UBHEWAL	0226FL03	11 KV CHATHE AP 1	AMR	OK	31.03.2023	AP 3Phase 3Wire				9141062	1200-600/5	2.496	NA	Director/D		
B.8999	South	SANGRUR	11KV	DS CITY DIVN. SUNAM	DS S/D UBHEWAL	0226FL12	11 KV KILA BHARIAN AP	AMR	OK	31.03.2023	AP 3Phase 3Wire				15193902	900-450/5	2.591	NA	Director/D		
B.9000	South	SANGRUR	11KV	DS CITY DIVN. SUNAM	DS S/D UBHEWAL	0226FL11	11 KV CHATHE SEKHWA AP 2	AMR	OK	31.03.2023	AP 3Phase 3Wire				11116836	1200-600/5	2.893	NA	Director/D		
B.9001	South	SANGRUR	11KV	DS CITY DIVN. SUNAM	DS S/D UBHEWAL	0226FL06	11 KV DUGGAN 2 AP	AMR	OK	31.03.2023	AP 3Phase 3Wire				7042895	900-450/5	3.093	NA	Director/D		
B.9002	South	SANGRUR	11KV	DS CITY DIVN. SUNAM	DS S/D UBHEWAL	0226FL10	11KV TEELA ROAD AP	AMR	OK	31.03.2023	AP 3Phase 3Wire				11117247	1200-600/5	3.223	NA	Director/D		
B.9003	South	SANGRUR	11KV	DS CITY DIVN. SUNAM	DS S/D UBHEWAL	0226FL02	11 KV UBHEWAL AP	AMR	OK	31.03.2023	AP 3Phase 3Wire				9141064	1200-600/5	4.160	NA	Director/D		
B.9004	South	SANGRUR	11KV	DS CITY DIVN. SUNAM	DS S/D UBHEWAL	0226FL07	11 KV UBHEWAL URBAN	AMR	OK	31.03.2023	Category 1				2044529	900-450/5	6.024	NA	Director/D		
B.9005	South	SANGRUR	11KV	DS CITY DIVN. SUNAM	DS S/D UBHEWAL	0226FL04	11 KV MAMOL UPS	AMR	OK	31.03.2023	Category 5-UPS				8223849	1200-600/5	8.673	NA	Director/D		
B.9006	South	SANGRUR	11KV	DS CITY DIVN. SUNAM	DS S/D S/D SUNAM	8204FL14	11 KV NEELOWAL UPS	AMR	OK	31.03.2023	Category 5-UPS				2068263	1200-600/5	0.581	NA	Director/D		
B.9007	South	SANGRUR	11KV	DS CITY DIVN. SUNAM	DS S/D S/D SUNAM	8204FL06	11 KV GHASIWALA AP (220KV SUNAM)	AMR	OK	31.03.2023	AP 3Phase 3Wire				8223369	1200-600/5	1.951	NA	Director/D		
B.9008	South	SANGRUR	11KV	DS CITY DIVN. SUNAM	DS S/D S/D SUNAM	8204FL07	11 KV BAKSHIWALA-AP(220 SUNAM)	NON AMR	OK	31.03.2023	AP 3Phase 3Wire				8223370	1200-600/5	2.059	NA	Director/D		
B.9009	South	SANGRUR	11KV	DS CITY DIVN. SUNAM	DS S/D S/D SUNAM	X229FL99	SUB STATION TRANSFORMER BAKSHIWA	AMR	OK	31.03.2023	Substation Transformer				85355	1200/577/1-1	0.019	NA	Director/D		
B.9010	South	SANGRUR	11KV	DS CITY DIVN. SUNAM	DS S/D S/D SUNAM	X229FL04	11 KV NEELOWAL ROAD AP	AMR	OK	31.03.2023	AP 3Phase 3Wire				34857	1200/577/1-1	1.304	NA	Director/D		
B.9011	South	SANGRUR	11KV	DS CITY DIVN. SUNAM	DS S/D S/D SUNAM	X229FL10	11 KV BABA CHETAN DASS AP	AMR	OK	31.03.2023	AP 3Phase 3Wire				15192296	1200/577/1-1	2.112	NA	Director/D		
B.9012	South	SANGRUR	11KV	DS CITY DIVN. SUNAM	DS S/D S/D SUNAM	X229FL06	11 KV SANSARPURA ROAD AP	NON AMR	OK	31.03.2023	AP 3Phase 3Wire				15192321	1200/577/1-1	2.140	NA	Director/D		
B.9013	South	SANGRUR	11KV	DS CITY DIVN. SUNAM	DS S/D S/D SUNAM	X229FL07	11 KV UGHRAHA ROAD AP	AMR	OK	31.03.2023	AP 3Phase 3Wire				15192345	1200/577/1-1	2.143	NA	Director/D		
B.9014	South	SANGRUR	11KV	DS CITY DIVN. SUNAM	DS S/D S/D SUNAM	X229FL02	11 KV HAMBALWAS AP(BAKSHIWALA G)	AMR	OK	31.03.2023	AP 3Phase 3Wire				36858	1200/577/1-1	2.250	NA	Director/D		
B.9015	South	SANGRUR	11KV	DS CITY DIVN. SUNAM	DS S/D S/D SUNAM	X229FL03	11 KV JAKHEPAL ROAD AP	AMR	OK	31.03.2023	AP 3Phase 3Wire				36836	1200/577/1-1	2.250	NA	Director/D		
B.9016	South	SANGRUR	11KV	DS CITY DIVN. SUNAM	DS S/D S/D SUNAM	X229FL05	11 KV SUNAM ROAD AP(BAKSHIWALA G)	AMR	OK	31.03.2023	AP 3Phase 3Wire				36870	1200/577/1-1	2.258	NA	Director/D		
B.9017	South	SANGRUR	11KV	DS CITY DIVN. SUNAM	DS S/D S/D SUNAM	X229FL01	11 KV BAKSHIWALA URBAN	NON AMR	OK	31.03.2023	Category 1				34066	1200/577/1-1	1.569	NA	Director/D		
B.9018	South	SANGRUR	11KV	DS CITY DIVN. SUNAM	DS S/D S/D SUNAM	X218FL99	SUB STATION TRANSFORMER CHATHE G	AMR	OK	31.03.2023	Substation Transformer				120571	900-450/577/1-1	0.030	NA	Director/D		
B.9019	South	SANGRUR	11KV	DS CITY DIVN. SUNAM	DS S/D S/D SUNAM	X218FL04	11 KV BABA RUKHHAR DASS AP	AMR	OK	31.03.2023	AP 3Phase 3Wire				13190525	900-450/577/1-1	1.544	NA	Director/D		
B.9020	South	SANGRUR	11KV	DS CITY DIVN. SUNAM	DS S/D S/D SUNAM	X218FL08	11 KV JAWANDHE AP(CHATHE GRID)	AMR	OK	31.03.2023	AP 3Phase 3Wire				15190606	900-450/577/1-1	1.560	NA	Director/D		
B.9021	South	SANGRUR	11KV	DS CITY DIVN. SUNAM	DS S/D S/D SUNAM	X218FL09	11 KV BABA ROTI RAM(CHATHE GRID)	AMR	OK	31.03.2023	AP 3Phase 3Wire				13190545	900-450/577/1-1	1.712	NA	Director/D		
B.9022	South	SANGRUR	11KV	DS CITY DIVN. SUNAM	DS S/D S/D SUNAM	X218FL07	11 KV SANT SEWA DASS AP	AMR	OK	31.03.2023	AP 3Phase 3Wire				15190607	900-450/577/1-1	2.205	NA	Director/D		
B.9023	South	SANGRUR	11KV	DS CITY DIVN. SUNAM	DS S/D S/D SUNAM	X218FL05	11 KV KHADIAL-D AP(CHATHE GRID)	AMR	OK	31.03.2023	AP 3Phase 3Wire				12527371	900-450/577/1-1	2.228	NA	Director/D		
B.9024	South	SANGRUR	11KV	DS CITY DIVN. SUNAM	DS S/D S/D SUNAM	X218FL01	11 KV SANTIWALA AP	AMR	OK	31.03.2023	AP 3Phase 3Wire				13190511	900-450/577/1-1	2.719	NA	Director/D		
B.9025	South	SANGRUR	11KV	DS CITY DIVN. SUNAM	DS S/D S/D SUNAM	X218FL02	11 KV RATOLAN UPS	AMR	OK	31.03.2023	Category 5-UPS				13190521	900-450/577/1-1	5.121	NA	Director/D		
B.9026	South	SANGRUR	11KV	DS CITY DIVN. SUNAM	DS S/D S/D SUNAM	X218FL06	11 KV CHATHA NANEHRA URBAN	NON AMR	OK	31.03.2023	Category 1				2324	900-450/577/1-1	5.347	NA	Director/D		
B.9027	South	SANGRUR	11KV	DS CITY DIVN. SUNAM	DS S/D S/D SUNAM	0228FL99	SUB STATION TRANSFORMER CHHAALI	AMR	OK	31.03.2023	Substation Transformer				85238	1200-600/5	0.046	NA	Director/D		
B.9028	South	SANGRUR	11KV	DS CITY DIVN. SUNAM	DS S/D S/D SUNAM	0228FL21	11 KV FEEDER FOR 220 KV CHHAALI	AMR	OK	31.03.2023	Category 1				16194469	1200-600/5	0.084	NA	Director/D		
B.9029	South	SANGRUR	11KV	DS CITY DIVN. SUNAM	DS S/D S/D SUNAM	0228FL11	11 KV UGHRAHA AP(CHHAALI GRID)	AMR	OK	31.03.2023	AP 3Phase 3Wire				8223650	1200-600/5	0.597	NA	Director/D		
B.9030	South	SANGRUR	11KV	DS CITY DIVN. SUNAM	DS S/D S/D SUNAM	0228FL25	11 KV GURUSAR AP (CHHAALI GRID)	AMR	OK	31.03.2023	AP 3Phase 3Wire				9534377	1200-600/5	1.262	NA	Director/D		
B.9031	South	SANGRUR	11KV	DS CITY DIVN. SUNAM	DS S/D S/D SUNAM	0228FL08	11 KV RAMGARH JAWANDHE AP	AMR	OK	31.03.2023	AP 3Phase 3Wire				8223143	1200-600/5	1.508	NA	Director/D		
B.9032	South	SANGRUR	11KV	DS CITY DIVN. SUNAM	DS S/D S/D SUNAM	0228FL13	11 KV BABA ROTI RAM AP	AMR	OK	31.03.2023	AP 3Phase 3Wire				9154454	1200-600/5	1.745	NA	Director/D		
B.9033	South	SANGRUR	11KV	DS CITY DIVN. SUNAM	DS S/D S/D SUNAM	0228FL13	11 KV BABA ROTI RAM AP	AMR	OK	31.03.2023	AP 3Phase 3Wire				43149	1200-600/5	1.771	NA	Director/D		
B.9034	South	SANGRUR	11KV	DS CITY DIVN. SUNAM	DS S/D S/D SUNAM	0228FL31	Koulii Shah	AMR	OK	31.03.2023	AP 3Phase 3Wire				2731	1200-600/5	1.804	NA	Director/D		
B.9035	South	SANGRUR	11KV	DS CITY DIVN. SUNAM	DS S/D S/D SUNAM	0228FL30	Gugga Marhi	AMR	OK	31.03.2023	AP 3Phase 3Wire				2731	1200-600/5	1.866	NA	Director/D		
B.9036	South	SANGRUR	11KV	DS CITY DIVN. SUNAM	DS S/D S/D SUNAM	0228FL19	11 KV RAILWAY ROAD AP	AMR	OK	31.03.2023	AP 3Phase 3Wire				15196681	1200-600/5	1.924	NA	Director/D		
B.9037	South	SANGRUR	11KV	DS CITY DIVN. SUNAM	DS S/D S/D SUNAM	0228FL18	11 KV BABA CHATTAR DASS AP	AMR	OK	31.03.2023	AP 3Phase 3Wire				15199030	1200-600/5	2.075	NA	Director/D		
B.9038	South	SANGRUR	11KV	DS CITY DIVN. SUNAM	DS S/D S/D SUNAM	0228FL24	11 KV MOGRI TOWN AP(CHHAALI GRID)	AMR	OK	31.03.2023	AP 3Phase 3Wire				2023395	1200-600/5	2.022	NA	Director/D		
B.9039	South	SANGRUR	11KV	DS CITY DIVN. SUNAM	DS S/D S/D SUNAM	0228FL09	11 KV SUNAM ROAD AP(CHHAALI GRID)	AMR	OK	31.03.2023	AP 3Phase 3Wire				8223141	1200-600/5	2.150	NA	Director/D		
B.9040	South	SANGRUR	11KV	DS CITY DIVN. SUNAM	DS S/D S/D SUNAM	0228FL05	11 KV CHHAALI RURAL AP	AMR	OK	31.03.2023	AP 3Phase 3Wire				8223039	1200-600/5	2.208	NA	Director/D		
B.9041	South	SANGRUR	11KV	DS CITY DIVN. SUNAM	DS S/D S/D SUNAM	0228FL01	11 KV KOTHE ROHI RAM AP	AMR	OK	31.03.2023	AP 3Phase 3Wire				8223393	1200-600/5	2.412	NA	Director/D		
B.9042	South	SANGRUR	11KV	DS CITY DIVN. SUNAM	DS S/D S/D SUNAM	0228FL26	11 KV NEELOWAL AP(CHHAALI GRID)	AMR	OK	31.03.2023	AP 3Phase 3Wire				15199037	1200-600/5	4.060	NA	Director/D		
B.9043	South	SANGRUR	11KV	DS CITY DIVN. SUNAM	DS S/D S/D SUNAM	0228FL27	Nawi Chhali Urban	AMR	OK	31.03.2023	Category 1				5580	1200-600/5	4.423	NA	Director/D		
B.9044	South	SANGRUR	11KV	DS CITY DIVN. SUNAM	DS S/D S/D SUNAM	0228FL03	11 KV CHHAALI URBAN	AMR	OK	31.03.2023	Category 2				8927587	1200-600/5	7.805	NA	Director/D		
B.9045	South	SANGRUR	11KV	DS CITY DIVN. SUNAM	DS S/D S/D SUNAM	0228FL04	11 KV CHHAALI INDUSTRIAL	AMR	OK	31.03.2023	Category 2				2068563	1200-600/5	9.050	NA	Director/D		
B.9046	South	SANGRUR	11KV	DS CITY DIVN. SUNAM	DS S/D S/D SUNAM	X238FL99	SUB STATION TRANSFORMER MT SHERO	AMR	OK	31.03.2023	Substation Transformer				232789	600/577/1-1	0.017	NA	Director/D		
B.9047	South	SANGRUR	11KV	DS CITY DIVN. SUNAM	DS S/D S/D SUNAM	X238FL04	11 KV GHASIWAL AP(MODEL TOWN GR)	AMR	OK	31.03.2023	AP 3Phase 3Wire				15193732	600/577/1-1	2.386	NA	Director/D		
B.9048	South	SANGRUR	11KV	DS CITY DIVN. SUNAM	DS S/D S/D SUNAM	X238FL03	MODEL TOWN URBAN	AMR	OK	31.03.2023	Category 1				16194346	600/577/1-1	2.436	NA	Director/D		
B.9049	South	SANGRUR	11KV	DS CITY DIVN. SUNAM	DS S/D S/D SUNAM	0228FL09	11 KV GHASIWAL	AMR	OK	31.03.2023	Category 5-UPS				15193713	600/577/1-1	6.386	NA	Director/D		
B.9050	South	SANGRUR	11KV	DS CITY DIVN. SUNAM	DS S/D S/D SUNAM	0228FL07	11 KV KHADIAL-A AP(SULRAN GRID)	AMR	OK	31.03.2023	AP 3Phase 3Wire				8222875	900-450/5	2.774	NA	Director/D		
B.9051	South	SANGRUR	11KV	DS CITY DIVN. SUNAM	DS S/D S/D SUNAM	0228FL09	11 KV KHADIAL-B AP(SULRAN GRID)	AMR	OK	31.03.2023	AP 3Phase 3Wire				10281280	900-450/5	3.907	NA	Director/D		
B.9052	South	SANGRUR	11KV	DS CITY DIVN. SUNAM	DS S/D S/D SUNAM	X205FL20	11 KV KHADIAL-C AP(KULARAN GRID)	NON AMR	OK	31.03.2023	AP 3Phase 3Wire				11051964	900-450/5	3.029	NA	Director/D		
B.9053	South	SANGRUR	11KV	DS CITY DIVN. SUNAM	DS S/D S/D SUNAM	0223FL99	SUB STATION TRANSFORMER SUNAM	AMR	OK	31.03.2023	Substation Transformer				10154224	1200/577/1-1	0.021	NA	Director/D		
B.9054	South	SANGRUR	11KV	DS CITY DIVN. SUNAM																	

S.No	Zone	Circle	Voltage Level (kVA)	Division (kVA)	Sub-Division (kVA)	Feeder ID	Feeder Name	Feeder Metering Status (Metered/unmetered/AMR/AMI)	Status of Meter (Functional/Non-Functional)	Metering Date (Date of last actual meter reading/communication)	Feeder Type (Agr/Industrial/Mixed)	Status of Communication			Period from 01.04.2021 to 31.03.2022				Sales	Remarks (Source of data)
												% Data received through automatically by feeder AMR/AMI	Number of hours when meter was unable to communicate in overall	Total Number of hours in the period	Meter S.No	CT/PT ratio	Import (kWh)	Export (kWh)		
B.9088	South	SANGRUR	11KV	DS DIVN. DIRBA	DS CITY S/D DIRBA	D219FL02	11 KV KAMALPUR UPS	AMR	OK	31.03.2023	Category 5-UPS				6489713	900-450/5	5.518	NA	Director/D	
B.9089	South	SANGRUR	11KV	DS DIVN. DIRBA	DS CITY S/D DIRBA	D219FL06	DIALGARH	AMR	OK	31.03.2023	Category 5-UPS				2066408	900-450/5	7.187	NA	Director/D	
B.9090	South	SANGRUR	11KV	DS DIVN. DIRBA	DS CITY S/D DIRBA	X214FL10	Khanpur Nahri	AMR	OK	31.03.2023	AP 3Phase 3Wire				5425	1200/577/1-1-1	1.380	NA	Director/D	
B.9091	South	SANGRUR	11KV	DS DIVN. DIRBA	DS CITY S/D DIRBA	X214FL06	Khanpur Nahri	AMR	OK	31.03.2023	AP 3Phase 3Wire				1310033	1200/577/1-1-1	1.533	NA	Director/D	
B.9092	South	SANGRUR	11KV	DS DIVN. DIRBA	DS CITY S/D DIRBA	X231FL09	BABA SIDHWALA	AMR	OK	31.03.2023	AP 3Phase 3Wire				5877	900-450/577/1-1-1	1.294	NA	Director/D	
B.9093	South	SANGRUR	11KV	DS DIVN. DIRBA	DS CITY S/D DIRBA	X231FL07	MUNSHIHWALA AP	NON AMR	OK	31.03.2023	AP 3Phase 3Wire				7788	900-450/577/1-1-1	1.462	NA	Director/D	
B.9094	South	SANGRUR	11KV	DS DIVN. DIRBA	DS CITY S/D DIRBA	X231FL06	KAHLUDDASS	NON AMR	OK	31.03.2023	AP 3Phase 3Wire				15193702	900-450/577/1-1-1	2.011	NA	Director/D	
B.9095	South	SANGRUR	11KV	DS DIVN. DIRBA	DS CITY S/D DIRBA	X231FL05	BHARHUR	NON AMR	OK	31.03.2023	AP 3Phase 3Wire				15193717	900-450/577/1-1-1	2.027	NA	Director/D	
B.9096	South	SANGRUR	11KV	DS DIVN. DIRBA	DS CITY S/D DIRBA	X231FL03	MAGH DASS	NON AMR	OK	31.03.2023	AP 3Phase 3Wire				43195	900-450/577/1-1-1	2.078	NA	Director/D	
B.9097	South	SANGRUR	11KV	DS DIVN. DIRBA	DS CITY S/D DIRBA	X231FL04	SEHAL	NON AMR	OK	31.03.2023	AP 3Phase 3Wire				15193823	900-450/577/1-1-1	2.120	NA	Director/D	
B.9098	South	SANGRUR	11KV	DS DIVN. DIRBA	DS CITY S/D DIRBA	X231FL16	SAMURAN UPS	AMR	OK	31.03.2023	Category 5-UPS				15193721	900-450/577/1-1-1	5.591	NA	Director/D	
B.9099	South	SANGRUR	11KV	DS DIVN. DIRBA	DS CITY S/D DIRBA	D204FL01	BIALPUR	AMR	OK	31.03.2023	AP 3Phase 3Wire				37133	1200-600/5	4.017	NA	Director/D	
B.9100	South	SANGRUR	11KV	DS DIVN. DIRBA	DS S/D MEHLAN	X214FL09	Ghat Road	AMR	OK	31.03.2023	AP 3Phase 3Wire				4166	1200/577/1-1-1	1.443	NA	Director/D	
B.9101	South	SANGRUR	11KV	DS DIVN. DIRBA	DS S/D MEHLAN	X214FL03	NAGRA ROAD	AMR	OK	31.03.2023	AP 3Phase 3Wire				12093436	900-450/5	1.528	NA	Director/D	
B.9102	South	SANGRUR	11KV	DS DIVN. DIRBA	DS S/D MEHLAN	X214FL08	Kothi feeder	AMR	OK	31.03.2023	AP 3Phase 3Wire				15193667	1200/577/1-1-1	1.813	NA	Director/D	
B.9103	South	SANGRUR	11KV	DS DIVN. DIRBA	DS S/D MEHLAN	X214FL07	MAOURAN ROAD	AMR	OK	31.03.2023	AP 3Phase 3Wire				15193843	1200/577/1-1-1	2.004	NA	Director/D	
B.9104	South	SANGRUR	11KV	DS DIVN. DIRBA	DS S/D MEHLAN	X214FL04	DIRBA ROAD	AMR	OK	31.03.2023	AP 3Phase 3Wire				12093465	900-450/5	2.017	NA	Director/D	
B.9105	South	SANGRUR	11KV	DS DIVN. DIRBA	DS S/D MEHLAN	X214FL05	and dass	AMR	OK	31.03.2023	AP 3Phase 3Wire				12093580	900-450/5	2.105	NA	Director/D	
B.9106	South	SANGRUR	11KV	DS DIVN. DIRBA	DS S/D MEHLAN	X214FL02	SEKHON PATTI	AMR	OK	31.03.2023	AP 3Phase 3Wire				12093498	900-450/5	2.379	NA	Director/D	
B.9107	South	SANGRUR	11KV	DS DIVN. DIRBA	DS S/D MEHLAN	X214FL01	GULURAN CI	AMR	OK	31.03.2023	AP 3Phase 3Wire				12093495	900-450/5	6.561	NA	Director/D	
B.9108	South	SANGRUR	11KV	DS DIVN. DIRBA	DS S/D MEHLAN	D222FL02	GULURAN A	AMR	OK	31.03.2023	Category 5-UPS				8222824	900-450/5	8.975	NA	Director/D	
B.9109	South	SANGRUR	11KV	DS DIVN. DIRBA	DS S/D MEHLAN	D222FL08	SULAR CITY	AMR	OK	31.03.2023	Category 1				299374	900-450/5	1.428	NA	Director/D	
B.9110	South	SANGRUR	11KV	DS DIVN. DIRBA	DS S/D MEHLAN	D222FL01	SULAR	AMR	OK	31.03.2023	Category 5-UPS				9154306	900-450/5	2.720	NA	Director/D	
B.9111	South	SANGRUR	11KV	DS DIVN. DIRBA	DS S/D MEHLAN	D222FL04	TARANJ KHERA	AMR	OK	31.03.2023	AP 3Phase 3Wire				9544715	900-450/5	3.967	NA	Director/D	
B.9112	South	SANGRUR	11KV	DS DIVN. DIRBA	DS S/D MEHLAN	D222FL05	GHRAT	AMR	OK	31.03.2023	Category 1				9141119	900-450/5	4.155	NA	Director/D	
B.9113	South	SANGRUR	11KV	DS DIVN. DIRBA	DS S/D MEHLAN	D222FL03	SATLUR	AMR	OK	31.03.2023	AP 3Phase 3Wire				8222821	900-450/5	4.381	NA	Director/D	
B.9114	South	SANGRUR	11KV	DS DIVN. DIRBA	DS S/D MEHLAN	D222FL10	GULURAN B	AMR	OK	31.03.2023	AP 3Phase 3Wire				9140809	900-450/5	4.885	NA	Director/D	
B.9115	South	SANGRUR	11KV	DS DIVN. DIRBA	DS S/D MEHLAN	X205FL03	KULAR KHURD	AMR	OK	31.03.2023	AP 3Phase 3Wire				9534574	900-450/5	1.271	NA	Director/D	
B.9116	South	SANGRUR	11KV	DS DIVN. DIRBA	DS S/D MEHLAN	X205FL04	KHERI-B	AMR	OK	31.03.2023	AP 3Phase 3Wire				9154447	900-450/5	2.172	NA	Director/D	
B.9117	South	SANGRUR	11KV	DS DIVN. DIRBA	DS S/D MEHLAN	X205FL02	MEHLAN-A	AMR	OK	31.03.2023	AP 3Phase 3Wire				9534999	900-450/5	2.823	NA	Director/D	
B.9118	South	SANGRUR	11KV	DS DIVN. DIRBA	DS S/D MEHLAN	X205FL09	Sangur Road	AMR	OK	31.03.2023	AP 3Phase 3Wire				12093473	900-450/5	2.954	NA	Director/D	
B.9119	South	SANGRUR	11KV	DS DIVN. DIRBA	DS S/D MEHLAN	X205FL06	MARD KHERA	AMR	OK	31.03.2023	AP 3Phase 3Wire				12093465	900-450/5	3.486	NA	Director/D	
B.9120	South	SANGRUR	11KV	DS DIVN. DIRBA	DS S/D MEHLAN	X205FL05	KULAR KHURD	AMR	OK	31.03.2023	Category 1				9534574	900-450/5	4.298	NA	Director/D	
B.9121	South	SANGRUR	11KV	DS DIVN. DIRBA	DS S/D MEHLAN	X205FL10	BalgiBasti /MEHLAN-B	AMR	OK	31.03.2023	AP 3Phase 3Wire				12093460	900-450/5	4.358	NA	Director/D	
B.9122	South	SANGRUR	11KV	DS DIVN. DIRBA	DS S/D MEHLAN	X205FL07	TUNGAN	AMR	OK	31.03.2023	AP 3Phase 3Wire				12093454	900-450/5	4.464	NA	Director/D	
B.9123	South	SANGRUR	11KV	DS DIVN. DIRBA	DS S/D MEHLAN	X205FL01	MEHLAN	AMR	OK	31.03.2023	Category 5-UPS				12093460	900-450/5	7.496	NA	Director/D	
B.9124	South	SANGRUR	11KV	DS DIVN. DIRBA	DS S/D MEHLAN	D220FL15	M & E SCHODL	AMR	OK	31.03.2023	Category 1				15193775	900-450/5	0.026	NA	Director/D	
B.9125	South	SANGRUR	11KV	DS DIVN. DIRBA	DS S/D MEHLAN	D220FL03	GAGAPUR	AMR	OK	31.03.2023	AP 3Phase 3Wire				8222811	900-450/5	1.420	NA	Director/D	
B.9126	South	SANGRUR	11KV	DS DIVN. DIRBA	DS S/D MEHLAN	D204FL17	11 KV Kheri	AMR	OK	31.03.2023	AP 3Phase 3Wire				4277	1200-600/5	2.220	NA	Director/D	
B.9127	South	SANGRUR	11KV	DS DIVN. DIRBA	DS S/D MEHLAN	D204FL02	SALUMA	AMR	OK	31.03.2023	AP 3Phase 3Wire				34036	1200-600/5	4.041	NA	Director/D	
B.9128	South	SANGRUR	11KV	DS DIVN. DIRBA	DS S/D MEHLAN	D204FL04	NAGRI	AMR	OK	31.03.2023	AP 3Phase 3Wire				37082	1200-600/5	4.136	NA	Director/D	
B.9129	South	SANGRUR	11KV	DS DIVN. DIRBA	DS S/D MEHLAN	D204FL08	24 HOURS FEEDER NO 4	AMR	OK	31.03.2023	Category 5-UPS				37198	1200-600/5	6.122	NA	Director/D	
B.9130	South	SANGRUR	11KV	DS DIVN. DIRBA	DS S/D MEHLAN	D204FL20	11 KV Nagra UPS	AMR	OK	31.03.2023	Category 5-UPS				4959	900-450/5	8.272	NA	Director/D	
B.9131	South	SANGRUR	11KV	DS DIVN. DIRBA	DS S/D MEHLAN	D223FL03	KULARAN	AMR	OK	31.03.2023	AP 3Phase 3Wire				1724	1200-600/5	1.976	NA	Director/D	
B.9132	South	SANGRUR	11KV	DS DIVN. DIRBA	DS S/D MEHLAN	D223FL06	MEHLAN	AMR	OK	31.03.2023	AP 3Phase 3Wire				1721	1200-600/5	2.079	NA	Director/D	
B.9133	South	SANGRUR	11KV	DS DIVN. DIRBA	DS S/D MEHLAN	D223FL15	BIGARWAL	AMR	OK	31.03.2023	AP 3Phase 3Wire				1710	1200-600/5	4.811	NA	Director/D	
B.9134	South	SANGRUR	11KV	DS DIVN. DIRBA	DS S/D NADAMPUR	X227FL09	S/S Bharo	AMR	OK	31.03.2023	Substation Transformer				55005	1200/577/1-1-1	0.032	NA	Director/D	
B.9135	South	SANGRUR	11KV	DS DIVN. DIRBA	DS S/D NADAMPUR	X227FL16	MNH INDUSTRIES BHARD	AMR	OK	31.03.2023	Category 4				42867	1200/577/1-1-1	0.426	NA	Director/D	
B.9136	South	SANGRUR	11KV	DS DIVN. DIRBA	DS S/D NADAMPUR	X227FL05	CITY BHARD	AMR	OK	31.03.2023	Category 1				33450	1200/577/1-1-1	1.578	NA	Director/D	
B.9137	South	SANGRUR	11KV	DS DIVN. DIRBA	DS S/D NADAMPUR	X227FL06	BHARAJ	AMR	OK	31.03.2023	AP 3Phase 3Wire				24353	1200/577/1-1-1	1.864	NA	Director/D	
B.9138	South	SANGRUR	11KV	DS DIVN. DIRBA	DS S/D NADAMPUR	X227FL04	BHARD	AMR	OK	31.03.2023	AP 3Phase 3Wire				24363	1200/577/1-1-1	1.965	NA	Director/D	
B.9139	South	SANGRUR	11KV	DS DIVN. DIRBA	DS S/D NADAMPUR	X227FL14	Kheri Gillan	AMR	OK	31.03.2023	AP 3Phase 3Wire				5446	1200/577/1-1-1	2.071	NA	Director/D	
B.9140	South	SANGRUR	11KV	DS DIVN. DIRBA	DS S/D NADAMPUR	X227FL03	SHAPUR	AMR	OK	31.03.2023	AP 3Phase 3Wire				24310	1200/577/1-1-1	2.660	NA	Director/D	
B.9141	South	SANGRUR	11KV	DS DIVN. DIRBA	DS S/D NADAMPUR	X227FL07	UPA	AMR	OK	31.03.2023	Category 5-UPS				9154312	1200/577/1-1-1	1.384	NA	Director/D	
B.9142	South	SANGRUR	11KV	DS DIVN. DIRBA	DS S/D NADAMPUR	D177FL11	LAKHEWAL	AMR	OK	31.03.2023	AP 3Phase 3Wire				8222806	Not installed	1.935	NA	Director/D	
B.9143	South	SANGRUR	11KV	DS DIVN. DIRBA	DS S/D NADAMPUR	D177FL02	CHAND	AMR	OK	31.03.2023	AP 3Phase 3Wire				12479479	Not installed	2.123	NA	Director/D	
B.9144	South	SANGRUR	11KV	DS DIVN. DIRBA	DS S/D NADAMPUR	D177FL01	NOORPURA	AMR	OK	31.03.2023	AP 3Phase 3Wire				12479599	Not installed	2.198	NA	Director/D	
B.9145	South	SANGRUR	11KV	DS DIVN. DIRBA	DS S/D NADAMPUR	D177FL06	INDUSTRY	AMR	OK	31.03.2023	Category 2				2066300	Not installed	3.884	NA	Director/D	
B.9146	South	SANGRUR	11KV	DS DIVN. DIRBA	DS S/D NADAMPUR	D177FL13	PREM	AMR	OK	31.03.2023	Category 2				539023	Not installed	2.046	NA	Director/D	
B.9147	South	SANGRUR	11KV	DS DIVN. DIRBA	DS S/D NADAMPUR	D220FL11	MAHA-2	AMR	OK	31.03.2023	AP 3Phase 3Wire				12093444	900-450/577/1-1-1	2.216	NA	Director/D	
B.9148	South	SANGRUR	11KV	DS DIVN. DIRBA	DS S/D NADAMPUR	D206FL16	11 KV Turri	AMR	OK	31.03.2023	AP 3Phase 3Wire				12093444	900-450/5	2.304	NA	Director/D	
B.9149	South	SANGRUR	11KV	DS DIVN. DIRBA	DS S/D NADAMPUR	D206FL05	MAHA	AMR	OK	31.03.2023	AP 3Phase 3Wire				4221063	900-450/5	2.728	NA	Director/D	
B.9150	South	SANGRUR	11KV	DS DIVN. DIRBA	DS S/D NADAMPUR	D205FL19	BALAD KHURD	AMR	OK	31.03.2023	AP 3Phase 3Wire				2066881	1200-600/5	1.725	NA	Director/D	
B.9151	South	SANGRUR	11KV	DS DIVN. DIRBA	DS S/D NADAMPUR	D205FL02	MAJHI	AMR	OK	31.03.2023	AP 3Phase 3Wire				8223414	1200-600/5	2.073	NA	Director/D	
B.9152	South	SANGRUR	11KV	DS DIVN. DIRBA	DS S/D NADAMPUR	D205FL10	24 HOURS TURI	NON AMR	OK	31.03.2023	Category 5-UPS				2067664	1200/577/1-1-1	3.335	NA	Director/D	
B.9153	South	SANGRUR	11KV	DS DIVN. DIRBA	DS S/D NADAMPUR	D222FL19	Azur Renewable	AMR	OK	31.03.2023	Category 1				48351	900-450/5	0.020	NA	Director/D	
B.9154	South	SANGRUR	11KV	DS DIVN. DIRBA	DS S/D NADAMPUR	D222FL18	San Solar	AMR	OK											

S.No	Zone	Circle	Voltage Level (kVA)	Division (kVA)	Sub-Division (kVA)	Feeder ID	Feeder Name	Feeder Metering Status (Metered/unmetered/AMR/AMI)	Status of Meter (Functional/Non-Functional)	Metering Date (Date of last actual meter reading/communication)	Feeder Type (Agr/Industrial/Mixed)	Status of Communication			Period from 01.04.2021 to 31.03.2022				Sales	Remarks (Source of data)
												% data received through automatically if feeder AMR/AMI	Number of hours when meter was unable to communicate in week	Total Number of hours in the period	Meter S.No	CT/PT ratio	Import (kU)	Export (kU)		
B.9185	South	SANGRUR	11KV	DS DIVN. DIRBA	DS S/U S/D DIRBA	X224FL05	Ladwajara	AMR	OK	31.03.2023	AP 3Phase 3Wire				33401	1200/577/1-1-1	2,096	NA	Director/D	
B.9186	South	SANGRUR	11KV	DS DIVN. DIRBA	DS S/U S/D DIRBA	X224FL3	Kakuwala	AMR	OK	31.03.2023	AP 3Phase 3Wire				33533	1200/577/1-1-1	2,099	NA	Director/D	
B.9187	South	SANGRUR	11KV	DS DIVN. DIRBA	DS S/U S/D DIRBA	X224FL02	11 KV Rogla	AMR	OK	31.03.2023	AP 3Phase 3Wire				33532	1200/577/1-1-1	2,118	NA	Director/D	
B.9188	South	SANGRUR	11KV	DS DIVN. DIRBA	DS S/U S/D DIRBA	X224FL01	Kakuwala	AMR	OK	31.03.2023	AP 3Phase 3Wire				33549	1200/577/1-1-1	2,337	NA	Director/D	
B.9189	South	SANGRUR	11KV	DS DIVN. DIRBA	DS S/U S/D DIRBA	X224FL04	Baba Rohi wala	AMR	OK	31.03.2023	AP 3Phase 3Wire				33516	1200/577/1-1-1	2,413	NA	Director/D	
B.9190	South	SANGRUR	11KV	DS DIVN. DIRBA	DS S/U S/D DIRBA	X224FL07	Ladwajara C-1	AMR	OK	31.03.2023	Category 1				33506	1200/577/1-1-1	3,385	NA	Director/D	
B.9191	South	SANGRUR	11KV	DS DIVN. DIRBA	DS S/U S/D DIRBA	X224FL06	Khedhi Naga	AMR	OK	31.03.2023	Category 5-U/PS				33376	1200/577/1-1-1	9,637	NA	Director/D	
B.9192	South	SANGRUR	11KV	DS DIVN. DIRBA	DS S/U S/D DIRBA	X224FL19	S/S Munshiwala	NON AMR	OK	31.03.2023	Substation Transformer				125900	900-450/577/1-1-1	0,018	NA	Director/D	
B.9193	South	SANGRUR	11KV	DS DIVN. DIRBA	DS S/U S/D DIRBA	X231FL01	MUNSHIWALA	AMR	OK	31.03.2023	Category 1				43196	900-450/577/1-1-1	0,066	NA	Director/D	
B.9194	South	SANGRUR	11KV	DS DIVN. DIRBA	DS S/U S/D DIRBA	X231FL08	KIDAL	NON AMR	OK	31.03.2023	AP 3Phase 3Wire				1460	900-450/577/1-1-1	2,344	NA	Director/D	
B.9195	South	SANGRUR	11KV	DS DIVN. DIRBA	DS S/U S/D DIRBA	X231FL03	SINDHRAN	AMR	OK	31.03.2023	AP 3Phase 3Wire				43226	900-450/577/1-1-1	2,345	NA	Director/D	
B.9196	South	SANGRUR	11KV	DS DIVN. DIRBA	DS S/U S/D DIRBA	D022FL06	DHANDOLI KALAN	AMR	OK	31.03.2023	AP 3Phase 3Wire				9534430	900-450/577/1-1-1	3,577	NA	Director/D	
B.9197	South	SANGRUR	11KV	DS DIVN. DIRBA	DS S/U S/D DIRBA	D022FL14	S/S Kohrian	AMR	OK	31.03.2023	Substation Transformer				5342466	900-450/577/1-1-1	0,014	NA	Director/D	
B.9198	South	SANGRUR	11KV	DS DIVN. DIRBA	DS S/U S/D DIRBA	D022FL09	UBHIA A	AMR	OK	31.03.2023	AP 3Phase 3Wire				8223444	900-450/577/1-1-1	1,984	NA	Director/D	
B.9199	South	SANGRUR	11KV	DS DIVN. DIRBA	DS S/U S/D DIRBA	D022FL13	Stadium Road	AMR	OK	31.03.2023	AP 3Phase 3Wire				9154981	900-450/577/1-1-1	2,026	NA	Director/D	
B.9200	South	SANGRUR	11KV	DS DIVN. DIRBA	DS S/U S/D DIRBA	D022FL06	LADBNARA-2	AMR	OK	31.03.2023	AP 3Phase 3Wire				8223441	900-450/577/1-1-1	2,498	NA	Director/D	
B.9201	South	SANGRUR	11KV	DS DIVN. DIRBA	DS S/U S/D DIRBA	D022FL11	11KV BABA NINE GAJIA	AMR	OK	31.03.2023	AP 3Phase 3Wire				13190462	900-450/577/1-1-1	3,002	NA	Director/D	
B.9202	South	SANGRUR	11KV	DS DIVN. DIRBA	DS S/U S/D DIRBA	D022FL07	CHIAHAR A	AMR	OK	31.03.2023	AP 3Phase 3Wire				9154062	900-450/577/1-1-1	3,297	NA	Director/D	
B.9203	South	SANGRUR	11KV	DS DIVN. DIRBA	DS S/U S/D DIRBA	D022FL02	UBHIA B	AMR	OK	31.03.2023	AP 3Phase 3Wire				8223646	900-450/577/1-1-1	3,538	NA	Director/D	
B.9204	South	SANGRUR	11KV	DS DIVN. DIRBA	DS S/U S/D DIRBA	D022FL04	ROREWALA	AMR	OK	31.03.2023	AP 3Phase 3Wire				8223443	900-450/577/1-1-1	3,686	NA	Director/D	
B.9205	South	SANGRUR	11KV	DS DIVN. DIRBA	DS S/U S/D DIRBA	D022FL05	CHIAHAR B	AMR	OK	31.03.2023	AP 3Phase 3Wire				9544682	900-450/577/1-1-1	3,722	NA	Director/D	
B.9206	South	SANGRUR	11KV	DS DIVN. DIRBA	DS S/U S/D DIRBA	D022FL01	KOHRAN	AMR	OK	31.03.2023	Category 1				5342466	900-450/577/1-1-1	3,762	NA	Director/D	
B.9207	South	SANGRUR	11KV	DS DIVN. DIRBA	DS S/U S/D DIRBA	D022FL12	GHOODE NAB	AMR	OK	31.03.2023	AP 3Phase 3Wire				15193729	900-450/577/1-1-1	4,056	NA	Director/D	
B.9208	South	SANGRUR	11KV	DS DIVN. DIRBA	DS S/U S/D DIRBA	D022FL08	ROGLA-2	AMR	OK	31.03.2023	Category 5-U/PS				10281322	900-450/577/1-1-1	4,183	NA	Director/D	
B.9209	South	SANGRUR	11KV	DS DIVN. DIRBA	DS S/U S/D DIRBA	D022FL10	Chahar	NON AMR	OK	31.03.2023	Category 5-U/PS				9154381	900-450/577/1-1-1	12,744	NA	Director/D	
B.9210	South	SANGRUR	11KV	DS DIVN. DIRBA	DS S/U S/D DIRBA	D018FL17	Hanghali NAB	AMR	OK	31.03.2023	AP 3Phase 3Wire				13190524	1200-600/577/1-1-1	1,844	NA	Director/D	
B.9211	South	SANGRUR	11KV	DS DIVN. PATRAN	DS CITY S/D PATRAN	B154FL23	S/S patran	AMR	OK	31.03.2023	Substation Transformer				11114608	900-450/577/1-1-1	0,091	NA	Director/D	
B.9212	South	SANGRUR	11KV	DS DIVN. PATRAN	DS CITY S/D PATRAN	B154FL16	Nihalgarh	NON AMR	OK	31.03.2023	AP 3Phase 3Wire				9140764	1200-600/577/1-1-1	0,530	NA	Director/D	
B.9213	South	SANGRUR	11KV	DS DIVN. PATRAN	DS CITY S/D PATRAN	B154FL26	New Dugal	AMR	OK	31.03.2023	AP 3Phase 3Wire				39	900-450/577/1-1-1	1,438	NA	Director/D	
B.9214	South	SANGRUR	11KV	DS DIVN. PATRAN	DS CITY S/D PATRAN	B154FL21	TILLA SAHIB	AMR	OK	31.03.2023	AP 3Phase 3Wire				11112345	900-450/577/1-1-1	2,077	NA	Director/D	
B.9215	South	SANGRUR	11KV	DS DIVN. PATRAN	DS CITY S/D PATRAN	B154FL18	DHAB	AMR	OK	31.03.2023	AP 3Phase 3Wire				9154331	900-450/577/1-1-1	2,276	NA	Director/D	
B.9216	South	SANGRUR	11KV	DS DIVN. PATRAN	DS CITY S/D PATRAN	B154FL04	Duggal(MUNSHIWALA)	AMR	OK	31.03.2023	Category 1				763	1200-600/577/1-1-1	2,688	NA	Director/D	
B.9217	South	SANGRUR	11KV	DS DIVN. PATRAN	DS CITY S/D PATRAN	B154FL02	BHOOTGARH-1	AMR	OK	31.03.2023	AP 3Phase 3Wire				9140764	1200-600/577/1-1-1	2,872	NA	Director/D	
B.9218	South	SANGRUR	11KV	DS DIVN. PATRAN	DS CITY S/D PATRAN	B154FL09	HARIJU	AMR	OK	31.03.2023	AP 3Phase 3Wire				663	900-450/577/1-1-1	2,880	NA	Director/D	
B.9219	South	SANGRUR	11KV	DS DIVN. PATRAN	DS CITY S/D PATRAN	B154FL01	RAIDHRANA-1	AMR	OK	31.03.2023	AP 3Phase 3Wire				9140764	1200-600/577/1-1-1	3,194	NA	Director/D	
B.9220	South	SANGRUR	11KV	DS DIVN. PATRAN	DS CITY S/D PATRAN	B154FL19	Choonagra	AMR	OK	31.03.2023	AP 3Phase 3Wire				10277325	900-450/577/1-1-1	3,450	NA	Director/D	
B.9221	South	SANGRUR	11KV	DS DIVN. PATRAN	DS CITY S/D PATRAN	B154FL03	SHADHARI-1	AMR	OK	31.03.2023	AP 3Phase 3Wire				9140761	1200-600/577/1-1-1	4,026	NA	Director/D	
B.9222	South	SANGRUR	11KV	DS DIVN. PATRAN	DS CITY S/D PATRAN	B154FL40	CITY-4-NEW	AMR	OK	31.03.2023	Category 1				5991	900-450/577/1-1-1	5,662	NA	Director/D	
B.9223	South	SANGRUR	11KV	DS DIVN. PATRAN	DS CITY S/D PATRAN	B154FL15	JEONPURA UPS	AMR	OK	31.03.2023	Category 5-U/PS				2202554	900-450/577/1-1-1	6,567	NA	Director/D	
B.9224	South	SANGRUR	11KV	DS DIVN. PATRAN	DS CITY S/D PATRAN	B154FL14	City-1	AMR	OK	31.03.2023	Category 1				11114572	1200-600/577/1-1-1	9,468	NA	Director/D	
B.9225	South	SANGRUR	11KV	DS DIVN. PATRAN	DS CITY S/D PATRAN	B154FL41	CITY 6	NON AMR	OK	31.03.2023	Category 1				2202554	1200-600/577/1-1-1	9,707	NA	Director/D	
B.9226	South	SANGRUR	11KV	DS DIVN. PATRAN	DS CITY S/D PATRAN	B154FL22	CITY-5	AMR	OK	31.03.2023	Category 1				9140761	1200-600/577/1-1-1	10,765	NA	Director/D	
B.9227	South	SANGRUR	11KV	DS DIVN. PATRAN	DS CITY S/D PATRAN	B154FL05	CITY-2	NON AMR	OK	31.03.2023	Category 1				6761189	1200-600/577/1-1-1	12,139	NA	Director/D	
B.9228	South	SANGRUR	11KV	DS DIVN. PATRAN	DS CITY S/D PATRAN	TP12FL08	S/S duggal	AMR	OK	31.03.2023	Substation Transformer				0	900-450/577/1-1-1	0,171	NA	Director/D	
B.9229	South	SANGRUR	11KV	DS DIVN. PATRAN	DS CITY S/D PATRAN	P123FL04	BABA NANAK	AMR	OK	31.03.2023	AP 3Phase 3Wire				23309	900-450/577/1-1-1	2,128	NA	Director/D	
B.9230	South	SANGRUR	11KV	DS DIVN. PATRAN	DS CITY S/D PATRAN	P123FL03	Nihalgarh-2	AMR	OK	31.03.2023	AP 3Phase 3Wire				23477	900-450/577/1-1-1	2,665	NA	Director/D	
B.9231	South	SANGRUR	11KV	DS DIVN. PATRAN	DS CITY S/D PATRAN	P123FL02	Duggal-2	AMR	OK	31.03.2023	AP 3Phase 3Wire				23330	900-450/577/1-1-1	3,252	NA	Director/D	
B.9232	South	SANGRUR	11KV	DS DIVN. PATRAN	DS CITY S/D PATRAN	TP12FL10	TRILPAMP	AMR	OK	31.03.2023	AP 3Phase 3Wire				9140768	900-450/577/1-1-1	3,246	NA	Director/D	
B.9233	South	SANGRUR	11KV	DS DIVN. PATRAN	DS CITY S/D PATRAN	TP12FL01	JPS CHOUNAGARA	AMR	OK	31.03.2023	Category 5-U/PS				23451	900-450/577/1-1-1	6,092	NA	Director/D	
B.9234	South	SANGRUR	11KV	DS DIVN. PATRAN	DS CITY S/D PATRAN	TP12FL05	DUGGAL CITY	AMR	OK	31.03.2023	Category 1				36776	900-450/577/1-1-1	10,462	NA	Director/D	
B.9235	South	SANGRUR	11KV	DS DIVN. PATRAN	DS CITY S/D PATRAN	TP12FL14	UFS Nihalgarh	AMR	OK	31.03.2023	Category 5-U/PS				42100	900-450/577/1-1-1	14,205	NA	Director/D	
B.9236	South	SANGRUR	11KV	DS DIVN. PATRAN	DS CITY S/D PATRAN	0TP1FL14	Hariju	AMR	OK	31.03.2023	AP 3Phase 3Wire				5991	900-450/577/1-1-1	3,458	NA	Director/D	
B.9237	South	SANGRUR	11KV	DS DIVN. PATRAN	DS CITY S/D PATRAN	D188FL07	CITY-3	AMR	OK	31.03.2023	Category 2				4187874	900-450/577/1-1-1	19,385	NA	Director/D	
B.9238	South	SANGRUR	11KV	DS DIVN. PATRAN	DS CITY S/D PATRAN	B154FL06	SHADHARI-2	AMR	OK	31.03.2023	AP 3Phase 3Wire				9534449	1200-600/577/1-1-1	2,748	NA	Director/D	
B.9239	South	SANGRUR	11KV	DS DIVN. PATRAN	DS CITY S/D PATRAN	D188FL05	BHAMANNAJARA AP	AMR	OK	31.03.2023	AP 3Phase 3Wire				9140591	1200-600/577/1-1-1	2,089	NA	Director/D	
B.9240	South	SANGRUR	11KV	DS DIVN. PATRAN	DS CITY S/D PATRAN	D188FL08	DATRIWALA	AMR	OK	31.03.2023	AP 3Phase 3Wire				2067587	1200-600/577/1-1-1	3,568	NA	Director/D	
B.9241	South	SANGRUR	11KV	DS DIVN. PATRAN	DS CITY S/D PATRAN	D188FL15	BRASS-3	AMR	OK	31.03.2023	AP 3Phase 3Wire				7336664	1200-600/577/1-1-1	3,810	NA	Director/D	
B.9242	South	SANGRUR	11KV	DS DIVN. PATRAN	DS CITY S/D PATRAN	D188FL04	BRASS2	AMR	OK	31.03.2023	AP 3Phase 3Wire				9140666	1200-600/577/1-1-1	3,811	NA	Director/D	
B.9243	South	SANGRUR	11KV	DS DIVN. PATRAN	DS CITY S/D PATRAN	D188FL06	DHAB	AMR	OK	31.03.2023	AP 3Phase 3Wire				9140691	1200-600/577/1-1-1	4,066	NA	Director/D	
B.9244	South	SANGRUR	11KV	DS DIVN. PATRAN	DS CITY S/D PATRAN	D188FL20	JPS DATRIWALA	AMR	OK	31.03.2023	Category 5-U/PS				197939	1200-600/577/1-1-1	5,425	NA	Director/D	
B.9245	South	SANGRUR	11KV	DS DIVN. PATRAN	DS CITY S/D PATRAN	FL13D181	Ganesh Thread	AMR	OK	31.03.2023	Category 4				6676963	1200-600/577/1-1-1	6,098	NA	Director/D	
B.9246	South	SANGRUR	11KV	DS DIVN. PATRAN	DS CITY S/D PATRAN	FL02D173	BRASS-1	Not available	OK	31.03.2023	AP 3Phase 3Wire				11052085	Not installed	2,665	NA	Director/D	
B.9247	South	SANGRUR	11KV	DS DIVN. PATRAN	DS CITY S/D PATRAN	B154FL30	SS-1	NON AMR	OK	31.03.2023	Category 1				Not available	Not available	0,220	NA	Director/D	
B.9248	South	SANGRUR	11KV	DS DIVN. PATRAN	DS CITY S/D PATRAN	D188FL19	S/S	NON AMR	OK	31.03.2023	Substation Transformer				1527368	1200-600/577/1-1-1	0,021	NA	Director/D	
B.9																				

S.No	Zone	Circle	Voltage Level (kVA)	Division (kVA)	Sub-Division (kVA)	Feeder ID	Feeder Name	Feeder Metering Status (Metered/unmetered/AMR/AMI)	Status of Meter (Functional/Non-functional)	Metering Date (Date of last actual meter reading/communication)	Feeder Type (Agr/Industrial/Mixed)	Status of Communication			Period from 01.04.2021 to 31.03.2022				Sales	Remarks (Source of data)
												% data received through automatically if feeder AMR/AMI	Number of hours when meter was unable to communicate in overall	Total Number of hours in the period	Meter S.No	CT/PT ratio	Import (MU)	Export (MU)		
B-9282	South	SANGRUR	11KV	DS DIVN. PATRAN	DS S/D KHANOURI	0194FL03	KHANOURI KALAN	AMR	OK	31.03.2023	AP 3Phase 3Wire				9140676	900-450/5	1.742	NA	Director/D	
B-9283	South	SANGRUR	11KV	DS DIVN. PATRAN	DS S/D KHANOURI	0194FL10	Ghaggar AP	AMR	OK	31.03.2023	AP 3Phase 3Wire				9140677	900-450/5	2.405	NA	Director/D	
B-9284	South	SANGRUR	11KV	DS DIVN. PATRAN	DS S/D KHANOURI	0194FL04	BANARSI	AMR	OK	31.03.2023	AP 3Phase 3Wire				23222	1200-600/5	2.613	NA	Director/D	
B-9285	South	SANGRUR	11KV	DS DIVN. PATRAN	DS S/D KHANOURI	0194FL01	INDUSTRIAL	AMR	OK	31.03.2023	Category 2				6740725	900-450/5	4.218	NA	Director/D	
B-9286	South	SANGRUR	11KV	DS DIVN. PATRAN	DS S/D KHANOURI	0194FL02	BANARSI CITY	AMR	OK	31.03.2023	Category 1				6669359	900-450/5	4.715	NA	Director/D	
B-9287	South	SANGRUR	11KV	DS DIVN. PATRAN	DS S/D KHANOURI	0194FL07	UFS BOPUR	AMR	OK	31.03.2023	Category 5-UPS				10273811	900-450/5	9.546	NA	Director/D	
B-9288	South	SANGRUR	11KV	DS DIVN. PATRAN	DS S/D KHANOURI	0232FL04	ANDANA	AMR	OK	31.03.2023	AP 3Phase 3Wire				8222392	900-450/5	2.509	NA	Director/D	
B-9289	South	SANGRUR	11KV	DS DIVN. PATRAN	DS S/D KHANOURI	FL150232	GULLARI	AMR	OK	31.03.2023	AP 3Phase 3Wire				9140885	900-450/5	1.764	NA	Director/D	
B-9290	South	SANGRUR	11KV	DS DIVN. PATRAN	DS S/D KHANOURI	0233FL06	THASKA	AMR	OK	31.03.2023	AP 3Phase 3Wire				11116964	900-450/5	2.093	NA	Director/D	
B-9291	South	SANGRUR	11KV	DS DIVN. PATRAN	DS S/D KHANOURI	0233FL14	BHULLAN	AMR	OK	31.03.2023	AP 3Phase 3Wire				9140881	900-450/5	2.654	NA	Director/D	
B-9292	South	SANGRUR	11KV	DS DIVN. PATRAN	DS S/D KHANOURI	0233FL05	KARODA	NON AMR	OK	31.03.2023	AP 3Phase 3Wire				9154429	900-450/5	3.840	NA	Director/D	
B-9293	South	SANGRUR	11KV	DS DIVN. PATRAN	DS S/D KHANOURI	0179FL22	S/S	AMR	OK	31.03.2023	Substation Transformer				0	1200-600/5	0.012	NA	Director/D	
B-9294	South	SANGRUR	11KV	DS DIVN. PATRAN	DS S/D KHANOURI	0179FL05	SHERGARH	AMR	OK	31.03.2023	AP 3Phase 3Wire				9140729	1200-600/5	1.411	NA	Director/D	
B-9295	South	SANGRUR	11KV	DS DIVN. PATRAN	DS S/D KHANOURI	0179FL17	DHANOLI ROAD	NON AMR	OK	31.03.2023	AP 3Phase 3Wire				23578	1200-600/5	1.785	NA	Director/D	
B-9296	South	SANGRUR	11KV	DS DIVN. PATRAN	DS S/D KHANOURI	0179FL12	RASOOL	AMR	OK	31.03.2023	AP 3Phase 3Wire				93893-20900	1200-600/5	1.816	NA	Director/D	
B-9297	South	SANGRUR	11KV	DS DIVN. PATRAN	DS S/D KHANOURI	0179FL03	GULLARH	AMR	OK	31.03.2023	AP 3Phase 3Wire				9140730	1200-600/5	2.044	NA	Director/D	
B-9298	South	SANGRUR	11KV	DS DIVN. PATRAN	DS S/D KHANOURI	0179FL02	BHULLAN	AMR	OK	31.03.2023	AP 3Phase 3Wire				7336514	1200-600/5	2.077	NA	Director/D	
B-9299	South	SANGRUR	11KV	DS DIVN. PATRAN	DS S/D KHANOURI	0179FL10	GURDIRTPURA	AMR	OK	31.03.2023	AP 3Phase 3Wire				6679890	1200-600/5	2.199	NA	Director/D	
B-9300	South	SANGRUR	11KV	DS DIVN. PATRAN	DS S/D KHANOURI	0179FL06	MATOLI	AMR	OK	31.03.2023	AP 3Phase 3Wire				4219656	1200-600/5	2.305	NA	Director/D	
B-9301	South	SANGRUR	11KV	DS DIVN. PATRAN	DS S/D KHANOURI	0179FL16	KANGTHALU	AMR	OK	31.03.2023	AP 3Phase 3Wire				10273588	1200-600/5	2.336	NA	Director/D	
B-9302	South	SANGRUR	11KV	DS DIVN. PATRAN	DS S/D KHANOURI	0179FL26	Deva Sattar	AMR	OK	31.03.2023	AP 3Phase 3Wire				9140723	1200-600/5	2.353	NA	Director/D	
B-9303	South	SANGRUR	11KV	DS DIVN. PATRAN	DS S/D KHANOURI	0179FL08	GALOU	AMR	OK	31.03.2023	AP 3Phase 3Wire				6740712	1200-600/5	2.359	NA	Director/D	
B-9304	South	SANGRUR	11KV	DS DIVN. PATRAN	DS S/D KHANOURI	0179Z0	DRAIN	AMR	OK	31.03.2023	AP 3Phase 3Wire				23576	1200-600/5	2.486	NA	Director/D	
B-9305	South	SANGRUR	11KV	DS DIVN. PATRAN	DS S/D KHANOURI	0179FL13	DHABI	AMR	OK	31.03.2023	AP 3Phase 3Wire				9140626	1200-600/5	2.552	NA	Director/D	
B-9306	South	SANGRUR	11KV	DS DIVN. PATRAN	DS S/D KHANOURI	0179FL09	BEHER	AMR	OK	31.03.2023	AP 3Phase 3Wire				6743297	1200-600/5	2.628	NA	Director/D	
B-9307	South	SANGRUR	11KV	DS DIVN. PATRAN	DS S/D KHANOURI	0179FL01	SAGRA	AMR	OK	31.03.2023	AP 3Phase 3Wire				9140727	1200-600/5	2.678	NA	Director/D	
B-9308	South	SANGRUR	11KV	DS DIVN. PATRAN	DS S/D KHANOURI	0179FL14	KHANOURI-2	AMR	OK	31.03.2023	Category 1				9140726	1200-600/5	3.722	NA	Director/D	
B-9309	South	SANGRUR	11KV	DS DIVN. PATRAN	DS S/D KHANOURI	0179FL07	UFS TEIPUR	NON AMR	OK	31.03.2023	Category 5-UPS				10273812	1200-600/5	5.145	NA	Director/D	
B-9310	South	SANGRUR	11KV	DS DIVN. PATRAN	DS S/D KHANOURI	0179FL11	UFS THIRWA	AMR	OK	31.03.2023	Category 5-UPS				0	1200-600/5	9.759	NA	Director/D	
B-9311	South	SANGRUR	11KV	DS DIVN. PATRAN	DS S/D KHANOURI	0179FL04	KHANOURI PEER	AMR	OK	31.03.2023	Category 1				6740716	1200-600/5	10.992	NA	Director/D	
B-9312	South	SANGRUR	11KV	DS DIVN. PATRAN	DS S/D KHANOURI	0179FL02	KHANOURI 1	AMR	OK	31.03.2023	Category 1				11117098	1200-600/5	11.289	NA	Director/D	
B-9313	South	SANGRUR	11KV	DS DIVN. PATRAN	DS S/D SHATRANA	0194FL02	GULLARH (SAILWALA)	AMR	OK	31.03.2023	AP 3Phase 3Wire				23566	900-450/5/7/1-1	3.297	NA	Director/D	
B-9314	South	SANGRUR	11KV	DS DIVN. PATRAN	DS S/D SHATRANA	0194FL16	GULLARH + guga mari new link	AMR	OK	31.03.2023	AP 3Phase 3Wire				33632	1200-600/5	3.317	NA	Director/D	
B-9315	South	SANGRUR	11KV	DS DIVN. PATRAN	DS S/D SHATRANA	0180FL28	S/S	AMR	OK	31.03.2023	Substation Transformer				0	Not installed	0.046	NA	Director/D	
B-9316	South	SANGRUR	11KV	DS DIVN. PATRAN	DS S/D SHATRANA	0180FL05	Joge Wall	AMR	OK	31.03.2023	AP 3Phase 3Wire				9140694	Not installed	1.550	NA	Director/D	
B-9317	South	SANGRUR	11KV	DS DIVN. PATRAN	DS S/D SHATRANA	0180FL14	Pauid 2+ pauid nehri	AMR	OK	31.03.2023	AP 3Phase 3Wire				9154100	Not installed	2.807	NA	Director/D	
B-9318	South	SANGRUR	11KV	DS DIVN. PATRAN	DS S/D SHATRANA	0180FL07	Pauid 1+ pauid 3	AMR	OK	31.03.2023	AP 3Phase 3Wire				8223241	Not installed	2.907	NA	Director/D	
B-9319	South	SANGRUR	11KV	DS DIVN. PATRAN	DS S/D SHATRANA	0180FL18	JACHER-1	AMR	OK	31.03.2023	AP 3Phase 3Wire				11117252	Not installed	3.265	NA	Director/D	
B-9320	South	SANGRUR	11KV	DS DIVN. PATRAN	DS S/D SHATRANA	0180FL06	Kartarpura + kartarpura 2	AMR	OK	31.03.2023	AP 3Phase 3Wire				9140392	Not installed	3.368	NA	Director/D	
B-9321	South	SANGRUR	11KV	DS DIVN. PATRAN	DS S/D SHATRANA	0180FL25	GOBINPURA + gobindpura 2	AMR	OK	31.03.2023	AP 3Phase 3Wire				9140695	Not installed	3.496	NA	Director/D	
B-9322	South	SANGRUR	11KV	DS DIVN. PATRAN	DS S/D SHATRANA	0180FL13	Rasoli + rasoli 2	AMR	OK	31.03.2023	AP 3Phase 3Wire				9140590	900-450/5	3.556	NA	Director/D	
B-9323	South	SANGRUR	11KV	DS DIVN. PATRAN	DS S/D SHATRANA	FL102180	SHATRAN RURAL + ghaggar ap	AMR	OK	31.03.2023	AP 3Phase 3Wire				9140588	900-450/5	3.729	NA	Director/D	
B-9324	South	SANGRUR	11KV	DS DIVN. PATRAN	DS S/D SHATRANA	0180FL08	Hisa Nagar + hisa nagar 2	AMR	OK	31.03.2023	AP 3Phase 3Wire				9140586	Not installed	4.115	NA	Director/D	
B-9325	South	SANGRUR	11KV	DS DIVN. PATRAN	DS S/D SHATRANA	0180FL15	SHATRANA CITY +sisa nagar adda	AMR	OK	31.03.2023	Category 1				4180022	900-450/5	8.365	NA	Director/D	
B-9326	South	SANGRUR	11KV	DS DIVN. PATRAN	DS S/D SHATRANA	0180FL19	OM THIRD MILL	AMR	OK	31.03.2023	Category 4				36854	900-450/5	9.160	NA	Director/D	
B-9327	South	SANGRUR	11KV	DS DIVN. PATRAN	DS S/D SHATRANA	0180FL01	UFS Shadipur	AMR	OK	31.03.2023	Category 5-UPS				4486064	Not installed	10.805	NA	Director/D	
B-9328	South	SANGRUR	11KV	DS DIVN. PATRAN	DS S/D SHATRANA	FL180180	UFS PAIND	AMR	OK	31.03.2023	Category 5-UPS				11117252	900-450/5	11.036	NA	Director/D	
B-9329	South	SANGRUR	11KV	DS DIVN. PATRAN	DS S/D SHATRANA	0179FL12	NASKARNA + dera bikanerita new 1	AMR	OK	31.03.2023	AP 3Phase 3Wire				9140595	900-450/5/7/1-1	3.000	NA	Director/D	
B-9330	South	SANGRUR	11KV	DS DIVN. PATRAN	DS S/D PATRAN	B154FL11	KHASPURA	AMR	OK	31.03.2023	AP 3Phase 3Wire				9140603	1200-600/5	0.000	NA	Director/D	
B-9331	South	SANGRUR	11KV	DS DIVN. PATRAN	DS S/U S/D PATRAN	B154FL08	HAMCHERI	AMR	OK	31.03.2023	AP 3Phase 3Wire				39	1200-600/5	1.706	NA	Director/D	
B-9332	South	SANGRUR	11KV	DS DIVN. PATRAN	DS S/U S/D PATRAN	B154FL07	NOORPURA	AMR	OK	31.03.2023	AP 3Phase 3Wire				9140603	1200-600/5	2.152	NA	Director/D	
B-9333	South	SANGRUR	11KV	DS DIVN. PATRAN	DS S/U S/D PATRAN	B154FL12	NAWAGAON-1	AMR	OK	31.03.2023	AP 3Phase 3Wire				11114584	1200-600/5	2.480	NA	Director/D	
B-9334	South	SANGRUR	11KV	DS DIVN. PATRAN	DS S/U S/D PATRAN	B154FL06	NUK	AMR	OK	31.03.2023	AP 3Phase 3Wire				9140603	900-450/5/7/1-1	4.157	NA	Director/D	
B-9335	South	SANGRUR	11KV	DS DIVN. PATRAN	DS S/U S/D PATRAN	B154FL11	NEW KHASPUR	AMR	OK	31.03.2023	AP 3Phase 3Wire				9154331	1200-600/5	3.003	NA	Director/D	
B-9336	South	SANGRUR	11KV	DS DIVN. PATRAN	DS S/U S/D PATRAN	B154FL13	LALWA	AMR	OK	31.03.2023	AP 3Phase 3Wire				60221	1200-600/5	4.498	NA	Director/D	
B-9337	South	SANGRUR	11KV	DS DIVN. PATRAN	DS S/U S/D PATRAN	B154FL17	UFS DORALI	AMR	OK	31.03.2023	Category 5-UPS				4180056	1200-600/5	9.567	NA	Director/D	
B-9338	South	SANGRUR	11KV	DS DIVN. PATRAN	DS S/U S/D PATRAN	B154FL39	UFS MOTHER INDIA	AMR	OK	31.03.2023	Category 5-UPS				1000	900-450/5/7/1-1	10.635	NA	Director/D	
B-9339	South	SANGRUR	11KV	DS DIVN. PATRAN	DS S/U S/D PATRAN	0179FL12	S/S	AMR	OK	31.03.2023	Substation Transformer				16194309	900-450/5/7/1-1	0.007	NA	Director/D	
B-9340	South	SANGRUR	11KV	DS DIVN. PATRAN	DS S/U S/D PATRAN	0179FL09	PAWALLA GAT	AMR	OK	31.03.2023	AP 3Phase 3Wire				316094800	900-450/5/7/1-1	1.866	NA	Director/D	
B-9341	South	SANGRUR	11KV	DS DIVN. PATRAN	DS S/U S/D PATRAN	0179FL06	Khanwal-3	AMR	OK	31.03.2023	AP 3Phase 3Wire				23405	900-450/5/7/1-1	2.207	NA	Director/D	
B-9342	South	SANGRUR	11KV	DS DIVN. PATRAN	DS S/U S/D PATRAN	0179FL03	Sailwa	AMR	OK	31.03.2023	AP 3Phase 3Wire				23387	900-450/5/7/1-1	3.270	NA	Director/D	
B-9343	South	SANGRUR	11KV	DS DIVN. PATRAN	DS S/U S/D PATRAN	0179FL10	KHANG	AMR	OK	31.03.2023	AP 3Phase 3Wire				73161699	900-450/5/7/1-1	3.701	NA	Director/D	
B-9344	South	SANGRUR	11KV	DS DIVN. PATRAN	DS S/U S/D PATRAN	FL08DTP1	11 KV PATRAN FOODS	AMR	OK	31.03.2023	Category 4				13190037	900-450/5/7/1-1	3.794	NA	Director/D	
B-9345	South	SANGRUR	11KV	DS DIVN. PATRAN	DS S/U S/D PATRAN	0179FL04	HOTIPUR-2	AMR	OK	31.03.2023	AP 3Phase 3Wire				23537	900-450/5/7/1-1	4.298	NA	Director/D	
B-9346	South	SANGRUR	11KV	DS DIVN. PATRAN	DS S/U S/D PATRAN	0179FL08	PAWALLA	AMR	OK	31.03.2023	Category 5-UPS				23436	900-450/5/7/1-1	10.575	NA	Director/D	
B-9347	South	SANGRUR	11KV	DS DIVN. PATRAN	DS S/U S/D PATRAN	0180FL11	SUNDER NAGAR	AMR	OK	31.03.2023	AP 3Phase 3Wire									

S.No	Zone	Circle	Voltage Level (kVA)	Division (kVA)	Sub-Division (kVA)	Feeder ID	Feeder Name	Feeder Metering Status (Metered/unmetered/AMR/AMI)	Status of Meter (Functional/Non-Functional)	Metering Date (Date of last actual meter reading/communication)	Feeder Type (Agr/Industrial/Mixed)	Status of Communication			Period from 01.04.2021 to 31.03.2022			Sales	Remarks (Source of data)
												% Data received through automatically by feeder AMR/AMI	Number of hours when meter was unable to communicate in overall	Total Number of hours in the period	Meter S.No	CT/PT ratio	Import (kWh)		
B.9379	South	SANGRUR	11kV	DS DIVN. SANGRUR	DS CITY S/D SANGRUR	X239F06	DHIBER BASTI	AMR	OK	31.03.2023	Category 1	479935	1200/577/1-1-1	8.788	NA	Director/D			
B.9380	South	SANGRUR	11kV	DS DIVN. SANGRUR	DS CITY S/D SANGRUR	X239F03	Roy road	AMR	OK	31.03.2023	Category 1	197995	1200/577/1-1-1	9.292	NA	Director/D			
B.9381	South	SANGRUR	11kV	DS DIVN. SANGRUR	DS CITY S/D SANGRUR	X239F01	Sadar Bazar	AMR	OK	31.03.2023	Category 1	197993	1200/577/1-1-1	12.827	NA	Director/D			
B.9382	South	SANGRUR	11kV	DS DIVN. SANGRUR	DS CITY S/D SANGRUR	X202F01	HOSPITAL	AMR	OK	31.03.2023	Category 4	206463	200-100/5-5	1.808	NA	Director/D			
B.9383	South	SANGRUR	11kV	DS DIVN. SANGRUR	DS CITY S/D SANGRUR	X202F09	CITY SANGRUR	AMR	OK	31.03.2023	Category 1	2066463	1200-600/5	4.468	NA	Director/D			
B.9384	South	SANGRUR	11kV	DS DIVN. SANGRUR	DS CITY S/D SANGRUR	X202F03	DC ROAD SANGRUR	AMR	OK	31.03.2023	Category 1	2066487	200-100/5-5	10.895	NA	Director/D			
B.9385	South	SANGRUR	11kV	DS DIVN. SANGRUR	DS S/D BADRUKHAN	B203F10	UPLLI	AMR	OK	31.03.2023	AP 3Phase 3Wire	2067283	900-450/5	4.373	NA	Director/D			
B.9386	South	SANGRUR	11kV	DS DIVN. SANGRUR	DS S/D BADRUKHAN	B203F06	INDUSTRIAL	AMR	OK	31.03.2023	Category 2	2067960	900-450/5	10.474	NA	Director/D			
B.9387	South	SANGRUR	11kV	DS DIVN. SANGRUR	DS S/D BADRUKHAN	X234F03	Khirian	NON AMR	OK	31.03.2023	Category 1	583670	900-450/577/1-1-1	0.686	NA	Director/D			
B.9388	South	SANGRUR	11kV	DS DIVN. SANGRUR	DS S/D BADRUKHAN	X234F06	Kanjla road	AMR	OK	31.03.2023	AP 3Phase 3Wire	583698	900-450/577/1-1-1	2.342	NA	Director/D			
B.9389	South	SANGRUR	11kV	DS DIVN. SANGRUR	DS S/D BADRUKHAN	X234F07	Lidhra Road	AMR	OK	31.03.2023	AP 3Phase 3Wire	4705	900-450/577/1-1-1	2.356	NA	Director/D			
B.9390	South	SANGRUR	11kV	DS DIVN. SANGRUR	DS S/D BADRUKHAN	X234F04	Baba Rodhe	AMR	OK	31.03.2023	AP 3Phase 3Wire	583685	900-450/577/1-1-1	2.573	NA	Director/D			
B.9391	South	SANGRUR	11kV	DS DIVN. SANGRUR	DS S/D BADRUKHAN	X234F01	Rasaldar chhana	AMR	OK	31.03.2023	AP 3Phase 3Wire	583696	900-450/577/1-1-1	2.856	NA	Director/D			
B.9392	South	SANGRUR	11kV	DS DIVN. SANGRUR	DS S/D BADRUKHAN	X234F02	Bangwalli	NON AMR	OK	31.03.2023	Category 5-UPS	583679	900-450/577/1-1-1	6.266	NA	Director/D			
B.9393	South	SANGRUR	11kV	DS DIVN. SANGRUR	DS S/D BADRUKHAN	X234F05	Guddepurra	AMR	OK	31.03.2023	Category 1	578907	900-450/577/1-1-1	6.347	NA	Director/D			
B.9394	South	SANGRUR	11kV	DS DIVN. SANGRUR	DS S/D BADRUKHAN	X202F15	UPLLI UPS	AMR	OK	31.03.2023	Category 5-UPS	5948	1200-600/5	0.945	NA	Director/D			
B.9395	South	SANGRUR	11kV	DS DIVN. SANGRUR	DS S/D BADRUKHAN	X202F04	UBHEWAL	AMR	OK	31.03.2023	AP 3Phase 3Wire	9140926	200-100/5-5	2.147	NA	Director/D			
B.9396	South	SANGRUR	11kV	DS DIVN. SANGRUR	DS S/D BADRUKHAN	X202F07	HARERI	AMR	OK	31.03.2023	AP 3Phase 3Wire	6675934	1200-600/5	2.443	NA	Director/D			
B.9397	South	SANGRUR	11kV	DS DIVN. SANGRUR	DS S/D BADRUKHAN	X202F05	BADRUKHAN	AMR	OK	31.03.2023	AP 3Phase 3Wire	8223185	200-100/5-5	2.699	NA	Director/D			
B.9398	South	SANGRUR	11kV	DS DIVN. SANGRUR	DS S/D BADRUKHAN	X202F11	Baiguana	AMR	OK	31.03.2023	AP 3Phase 3Wire	37156	1200-600/5	2.714	NA	Director/D			
B.9399	South	SANGRUR	11kV	DS DIVN. SANGRUR	DS S/D BADRUKHAN	X202F08	BANGANALI	AMR	OK	31.03.2023	AP 3Phase 3Wire	9140927	200-100/5-5	3.056	NA	Director/D			
B.9400	South	SANGRUR	11kV	DS DIVN. SANGRUR	DS S/D BADRUKHAN	X202F12	BHAMABADI	NON AMR	OK	31.03.2023	AP 3Phase 3Wire	P883177	1200-600/5	3.499	NA	Director/D			
B.9401	South	SANGRUR	11kV	DS DIVN. SANGRUR	DS S/D BADRUKHAN	X202F14	Industrial Siana road	AMR	OK	31.03.2023	Category 2	15193872	1200-600/5	4.213	NA	Director/D			
B.9402	South	SANGRUR	11kV	DS DIVN. SANGRUR	DS S/D BADRUKHAN	X202F06	CHANGAL	AMR	OK	31.03.2023	AP 3Phase 3Wire	10288328	1200-600/5	4.301	NA	Director/D			
B.9403	South	SANGRUR	11kV	DS DIVN. SANGRUR	DS S/D BADRUKHAN	X202F13	Industrial	AMR	OK	31.03.2023	Category 2	15193865	1200-600/5	8.928	NA	Director/D			
B.9404	South	SANGRUR	11kV	DS DIVN. SANGRUR	DS S/D BADRUKHAN	X202F09	POLICE LINE	AMR	OK	31.03.2023	Category 1	7030279	200-100/5-5	12.491	NA	Director/D			
B.9405	South	SANGRUR	11kV	DS DIVN. SANGRUR	DS S/D BADRUKHAN	X202F10	MASTUANA SAHIB	AMR	OK	31.03.2023	Category 5-UPS	3194	1200-600/5	14.233	NA	Director/D			
B.9406	South	SANGRUR	11kV	DS DIVN. SANGRUR	DS S/D BHAWANIGARH	X217F08	Sub station	AMR	OK	31.03.2023	Substation Transformer	33610	900-450/577/1-1-1	0.005	NA	Director/D			
B.9407	South	SANGRUR	11kV	DS DIVN. SANGRUR	DS S/D BHAWANIGARH	X217F09	Bhattwal Khurd	AMR	OK	31.03.2023	AP 3Phase 3Wire	23282	900-450/577/1-1-1	1.715	NA	Director/D			
B.9408	South	SANGRUR	11kV	DS DIVN. SANGRUR	DS S/D BHAWANIGARH	X217F01	BALIAL (BHATTI)	AMR	OK	31.03.2023	AP 3Phase 3Wire	11112321	900-450/577/1-1-1	1.914	NA	Director/D			
B.9409	South	SANGRUR	11kV	DS DIVN. SANGRUR	DS S/D BHAWANIGARH	X217F02	BHATTIWA (BHTI)	AMR	OK	31.03.2023	AP 3Phase 3Wire	11122321	900-450/577/1-1-1	2.034	NA	Director/D			
B.9410	South	SANGRUR	11kV	DS DIVN. SANGRUR	DS S/D BHAWANIGARH	X217F04	Banspura (BHT)	AMR	OK	31.03.2023	AP 3Phase 3Wire	1252723	900-450/577/1-1-1	2.641	NA	Director/D			
B.9411	South	SANGRUR	11kV	DS DIVN. SANGRUR	DS S/D BHAWANIGARH	X217F03	Bhattwal (UPS)	AMR	OK	31.03.2023	Category 5-UPS	11125111	900-450/577/1-1-1	7.510	NA	Director/D			
B.9412	South	SANGRUR	11kV	DS DIVN. SANGRUR	DS S/D BHAWANIGARH	X226F11	Buth Singhwala	AMR	OK	31.03.2023	AP 3Phase 3Wire	5359	1200/577/1-1-1	0.345	NA	Director/D			
B.9413	South	SANGRUR	11kV	DS DIVN. SANGRUR	DS S/D BHAWANIGARH	X226F02	11 KV Gehlan C-1	AMR	OK	31.03.2023	Category 1	36969	1200/577/1-1-1	0.568	NA	Director/D			
B.9414	South	SANGRUR	11kV	DS DIVN. SANGRUR	DS S/D BHAWANIGARH	X226F07	Dhalwal	AMR	OK	31.03.2023	AP 3Phase 3Wire	15193741	1200/577/1-1-1	1.047	NA	Director/D			
B.9415	South	SANGRUR	11kV	DS DIVN. SANGRUR	DS S/D BHAWANIGARH	X226F05	11 kv Tibban wala	AMR	OK	31.03.2023	AP 3Phase 3Wire	37226	1200/577/1-1-1	1.240	NA	Director/D			
B.9416	South	SANGRUR	11kV	DS DIVN. SANGRUR	DS S/D BHAWANIGARH	X226F04	11 kv Rai Singh wala	AMR	OK	31.03.2023	AP 3Phase 3Wire	36921	1200/577/1-1-1	1.485	NA	Director/D			
B.9417	South	SANGRUR	11kV	DS DIVN. SANGRUR	DS S/D BHAWANIGARH	X226F03	11 kv Nand garh	AMR	OK	31.03.2023	AP 3Phase 3Wire	36973	1200/577/1-1-1	1.503	NA	Director/D			
B.9418	South	SANGRUR	11kV	DS DIVN. SANGRUR	DS S/D BHAWANIGARH	X226F01	11 kv Rasulpur channa UPS	AMR	OK	31.03.2023	Category 5-UPS	34438	1200/577/1-1-1	2.553	NA	Director/D			
B.9419	South	SANGRUR	11kV	DS DIVN. SANGRUR	DS S/D BHAWANIGARH	X206F07	BAKHOPUR URBAN	AMR	OK	31.03.2023	Category 1	10282805	900-450/577/1-1-1	1.282	NA	Director/D			
B.9420	South	SANGRUR	11kV	DS DIVN. SANGRUR	DS S/D BHAWANIGARH	X206F03	DALPURA	AMR	OK	31.03.2023	AP 3Phase 3Wire	16199244	900-450/5	1.815	NA	Director/D			
B.9421	South	SANGRUR	11kV	DS DIVN. SANGRUR	DS S/D BHAWANIGARH	X206F08	Bakhopur II	AMR	OK	31.03.2023	AP 3Phase 3Wire	10282808	900-450/577/1-1-1	1.187	NA	Director/D			
B.9422	South	SANGRUR	11kV	DS DIVN. SANGRUR	DS S/D BHAWANIGARH	X206F10	Bakhopur II	AMR	OK	31.03.2023	AP 3Phase 3Wire	12092472	900-450/577/1-1-1	2.225	NA	Director/D			
B.9423	South	SANGRUR	11kV	DS DIVN. SANGRUR	INDUSTERY (G/S/S, Bakhopur)	X206F12	INDUSTERY (G/S/S, Bakhopur)	AMR	OK	31.03.2023	Category 2	10283007	900-450/577/1-1-1	2.231	NA	Director/D			
B.9424	South	SANGRUR	11kV	DS DIVN. SANGRUR	DS S/D BHAWANIGARH	X206F04	GHULMAND SINGH WALA	AMR	OK	31.03.2023	AP 3Phase 3Wire	2360	900-450/5	2.302	NA	Director/D			
B.9425	South	SANGRUR	11kV	DS DIVN. SANGRUR	DS S/D BHAWANIGARH	X206F02	BAKHTRA	AMR	OK	31.03.2023	AP 3Phase 3Wire	36825	900-450/5	2.443	NA	Director/D			
B.9426	South	SANGRUR	11kV	DS DIVN. SANGRUR	DS S/D BHAWANIGARH	X206F13	KIRHAN	AMR	OK	31.03.2023	AP 3Phase 3Wire	92302478	900-450/577/1-1-1	2.064	NA	Director/D			
B.9427	South	SANGRUR	11kV	DS DIVN. SANGRUR	DS S/D BHAWANIGARH	X206F09	Paswan	AMR	OK	31.03.2023	AP 3Phase 3Wire	10282862	900-450/577/1-1-1	2.804	NA	Director/D			
B.9428	South	SANGRUR	11kV	DS DIVN. SANGRUR	DS S/D BHAWANIGARH	X206F01	BAKHOPUR	AMR	OK	31.03.2023	Category 5-UPS	23763	900-450/5	10.957	NA	Director/D			
B.9429	South	SANGRUR	11kV	DS DIVN. SANGRUR	DS S/D BHAWANIGARH	X203F10	KHERI	AMR	OK	31.03.2023	AP 3Phase 3Wire	37000	1200-600/5	2.487	NA	Director/D			
B.9430	South	SANGRUR	11kV	DS DIVN. SANGRUR	DS S/D BHAWANIGARH	X203F02	JAILAN	AMR	OK	31.03.2023	AP 3Phase 3Wire	2065757	1200/577/1-1-1	2.691	NA	Director/D			
B.9431	South	SANGRUR	11kV	DS DIVN. SANGRUR	DS S/D BHAWANIGARH	X203F14	Jain-2	AMR	OK	31.03.2023	AP 3Phase 3Wire	37073	1200-600/5	3.381	NA	Director/D			
B.9432	South	SANGRUR	11kV	DS DIVN. SANGRUR	DS S/D BHAWANIGARH	X202F13	11 kv 220 KV G/S/S	AMR	OK	31.03.2023	Category 1	37088	1200-600/5	1.462	NA	Director/D			
B.9433	South	SANGRUR	11kV	DS DIVN. SANGRUR	DS S/D BHAWANIGARH	X202F17	BHATTIWA (BHG)	AMR	OK	31.03.2023	AP 3Phase 3Wire	8222520	1200-600/5	1.731	NA	Director/D			
B.9434	South	SANGRUR	11kV	DS DIVN. SANGRUR	DS S/D BHAWANIGARH	X202F12	BALIAL (BHG)	AMR	OK	31.03.2023	AP 3Phase 3Wire	8222516	1200/577/1-1-1	1.995	NA	Director/D			
B.9435	South	SANGRUR	11kV	DS DIVN. SANGRUR	DS S/D BHAWANIGARH	X202F08	RAMPURA (BHG)	AMR	OK	31.03.2023	AP 3Phase 3Wire	8223415	1200-600/5	2.181	NA	Director/D			
B.9436	South	SANGRUR	11kV	DS DIVN. SANGRUR	DS S/D BHAWANIGARH	X202F18	BAKHOPUR	AMR	OK	31.03.2023	AP 3Phase 3Wire	2047141	1200-600/5	2.285	NA	Director/D			
B.9437	South	SANGRUR	11kV	DS DIVN. SANGRUR	DS S/D BHAWANIGARH	X202F09	BAKHOPUR	AMR	OK	31.03.2023	AP 3Phase 3Wire	36226	1200-600/5	2.477	NA	Director/D			
B.9438	South	SANGRUR	11kV	DS DIVN. SANGRUR	DS S/D BHAWANIGARH	X202F05	SANGATPURA	AMR	OK	31.03.2023	AP 3Phase 3Wire	8223413	1200-600/5	2.624	NA	Director/D			
B.9439	South	SANGRUR	11kV	DS DIVN. SANGRUR	DS S/D BHAWANIGARH	X202F07	KAKRA	AMR	OK	31.03.2023	AP 3Phase 3Wire	8223411	1200-600/5	2.732	NA	Director/D			
B.9440	South	SANGRUR	11kV	DS DIVN. SANGRUR	INDUSTRIAL (G/S/S, BHG)	X202F06	INDUSTRIAL (G/S/S, BHG)	AMR											

S.No	Zone	Circle	Voltage (kVA)	Division (kVA)	Sub-Division (kVA)	Feeder ID	Feeder Name	Feeder Metering Status (Metered/unmetered/AMR/AMI)	Status of Meter (Functional/Non-Functional)	Metering Date (Date of last actual meter reading/communication)	Feeder Type (Agr/Industrial/Mixed)	Status of Communication			Period from 01.04.2021 to 31.03.2022				Sales	Remarks (Source of data)
												% data received through automatically if feeder AMR/AMI	Number of hours when meter was unable to communicate in overall	Total Number of hours in the period	Meter S.No	CT/PT ratio	Import (kWh)	Export (kWh)		
B.9476	South	SANGRUR	11KV	DS DIVN. SANGRUR	DS S/D GHRACHON	D024FL10	KALOU DI	AMR	OK	31.03.2023	AP 3Phase 3Wire				37154	900-450/5	1,800	NA	Director/D	
B.9477	South	SANGRUR	11KV	DS DIVN. SANGRUR	DS S/D GHRACHON	D024FL19	Gharachon B	AMR	OK	31.03.2023	AP 3Phase 3Wire				4332	900-450/5	1,804	NA	Director/D	
B.9478	South	SANGRUR	11KV	DS DIVN. SANGRUR	DS S/D GHRACHON	D024FL22	Abbarpur-B	AMR	OK	31.03.2023	AP 3Phase 3Wire				5311	900-450/5	1,854	NA	Director/D	
B.9479	South	SANGRUR	11KV	DS DIVN. SANGRUR	DS S/D GHRACHON	D024FL21	NAGRA	AMR	OK	31.03.2023	AP 3Phase 3Wire				822497	900-450/5	2,108	NA	Director/D	
B.9480	South	SANGRUR	11KV	DS DIVN. SANGRUR	DS S/D GHRACHON	D024FL12	SAHIB DASS	AMR	OK	31.03.2023	AP 3Phase 3Wire				8222813	900-450/5	2,467	NA	Director/D	
B.9481	South	SANGRUR	11KV	DS DIVN. SANGRUR	DS S/D GHRACHON	D024FL18	Kaloudi A	AMR	OK	31.03.2023	AP 3Phase 3Wire				4277	1200-600/5	2,495	NA	Director/D	
B.9482	South	SANGRUR	11KV	DS DIVN. SANGRUR	DS S/D GHRACHON	D024FL07	GHRACHON	AMR	OK	31.03.2023	AP 3Phase 3Wire				37152	1200-600/5	2,608	NA	Director/D	
B.9483	South	SANGRUR	11KV	DS DIVN. SANGRUR	DS S/D GHRACHON	D024FL13	Sanghari	AMR	OK	31.03.2023	AP 3Phase 3Wire				37154	1200-600/5	2,705	NA	Director/D	
B.9484	South	SANGRUR	11KV	DS DIVN. SANGRUR	DS S/D GHRACHON	D024FL06	NAGRA	AMR	OK	31.03.2023	AP 3Phase 3Wire				822497	900-450/5	2,864	NA	Director/D	
B.9485	South	SANGRUR	11KV	DS DIVN. SANGRUR	DS S/D GHRACHON	D024FL14	GHRACHON CAT-1	AMR	OK	31.03.2023	Category 1				6679854	900-450/5	7,488	NA	Director/D	
B.9486	South	SANGRUR	11KV	DS DIVN. SANGRUR	DS S/D GHRACHON	D024FL09	GHRACHON SAHIB 24 HRS.	AMR	OK	31.03.2023	Category 5-UPS				15193699	900-450/5	7,693	NA	Director/D	
B.9487	South	SANGRUR	11KV	DS DIVN. SANGRUR	DS S/U S/D SANGRUR	B023FL08	PMPL	AMR	OK	31.03.2023	Category 4				2067720	900-450/5	0,051	NA	Director/D	
B.9488	South	SANGRUR	11KV	DS DIVN. SANGRUR	DS S/U S/D SANGRUR	B023FL11	Moonak Oil	AMR	OK	31.03.2023	Category 2				1312240	900-450/5	1,368	NA	Director/D	
B.9489	South	SANGRUR	11KV	DS DIVN. SANGRUR	DS S/U S/D SANGRUR	B023FL03	BAJWAL	AMR	OK	31.03.2023	AP 3Phase 3Wire				2067857	900-450/5	2,224	NA	Director/D	
B.9490	South	SANGRUR	11KV	DS DIVN. SANGRUR	DS S/U S/D SANGRUR	B023FL04	KANOI	AMR	OK	31.03.2023	AP 3Phase 3Wire				2068648	900-450/5	2,420	NA	Director/D	
B.9491	South	SANGRUR	11KV	DS DIVN. SANGRUR	DS S/U S/D SANGRUR	B023FL02	FOCAL POINT	AMR	OK	31.03.2023	Category 2				2068480	900-450/5	7,555	NA	Director/D	
B.9492	South	SANGRUR	11KV	DS DIVN. SANGRUR	DS S/U S/D SANGRUR	B023FL07	NICS	NON AMR	OK	31.03.2023	Category 4				2067739	900-450/5	13,074	NA	Director/D	
B.9493	South	SANGRUR	11KV	DS DIVN. SANGRUR	DS S/U S/D SANGRUR	D025FL07	SARON 2	AMR	OK	31.03.2023	AP 3Phase 3Wire				44921	1200/577/1-1-1	2,780	NA	Director/D	
B.9494	South	SANGRUR	11KV	DS DIVN. SANGRUR	DS S/U S/D SANGRUR	D025FL11	Fatehgarh Chhanna	AMR	OK	31.03.2023	AP 3Phase 3Wire				36824	1200/577/1-1-1	3,263	NA	Director/D	
B.9495	South	SANGRUR	11KV	DS DIVN. SANGRUR	DS S/U S/D SANGRUR	X216FL04	PATIALA ROAD	AMR	OK	31.03.2023	AP 3Phase 3Wire				23169	900-450/577/1-1-1	2,265	NA	Director/D	
B.9496	South	SANGRUR	11KV	DS DIVN. SANGRUR	DS S/U S/D SANGRUR	X216FL05	Bahad Road	AMR	OK	31.03.2023	AP 3Phase 3Wire				36843	900-450/577/1-1-1	2,062	NA	Director/D	
B.9497	South	SANGRUR	11KV	DS DIVN. SANGRUR	DS S/U S/D SANGRUR	X216FL02	GURDASPURA	AMR	OK	31.03.2023	AP 3Phase 3Wire				13190565	900-450/577/1-1-1	2,421	NA	Director/D	
B.9498	South	SANGRUR	11KV	DS DIVN. SANGRUR	DS S/U S/D SANGRUR	X216FL01	Kaloudi	AMR	OK	31.03.2023	Category 1				23169	900-450/577/1-1-1	3,394	NA	Director/D	
B.9499	South	SANGRUR	11KV	DS DIVN. SANGRUR	DS S/U S/D SANGRUR	X233FL07	Siban	AMR	OK	31.03.2023	AP 3Phase 3Wire				1454	900-450/577/1-1-1	2,349	NA	Director/D	
B.9500	South	SANGRUR	11KV	DS DIVN. SANGRUR	DS S/U S/D SANGRUR	X233FL06	Paran road	AMR	OK	31.03.2023	AP 3Phase 3Wire				583680	900-450/577/1-1-1	2,476	NA	Director/D	
B.9501	South	SANGRUR	11KV	DS DIVN. SANGRUR	DS S/U S/D SANGRUR	D023FL02	KanoI	AMR	OK	31.03.2023	Category 1				583688	900-450/577/1-1-1	2,402	NA	Director/D	
B.9502	South	SANGRUR	11KV	DS DIVN. SANGRUR	DS S/U S/D SANGRUR	D023FL03	KanoI	AMR	OK	31.03.2023	AP 3Phase 3Wire				583672	900-450/577/1-1-1	2,796	NA	Director/D	
B.9503	South	SANGRUR	11KV	DS DIVN. SANGRUR	DS S/U S/D SANGRUR	DA20FL01	Kammomajra	AMR	OK	31.03.2023	Category 5-UPS				579604	900-450/577/1-1-1	5,282	NA	Director/D	
B.9504	South	SANGRUR	11KV	DS DIVN. SANGRUR	DS S/U S/D SANGRUR	D020FL04	Jeevan Nagar	AMR	OK	31.03.2023	Category 1				579605	900-450/577/1-1-1	7,703	NA	Director/D	
B.9505	South	SANGRUR	11KV	DS DIVN. SANGRUR	DS S/U S/D SANGRUR	D020FL21	HOT LINE	AMR	OK	31.03.2023	Category 1				5731	1200-600/5	0,003	NA	Director/D	
B.9506	South	SANGRUR	11KV	DS DIVN. SANGRUR	DS S/U S/D SANGRUR	D020FL05	NH WALA	AMR	OK	31.03.2023	AP 3Phase 3Wire				8223992	1200-800/5	1,459	NA	Director/D	
B.9507	South	SANGRUR	11KV	DS DIVN. SANGRUR	DS S/U S/D SANGRUR	D020FL19	Nankapur	AMR	OK	31.03.2023	AP 3Phase 3Wire				15193774	1200-600/5	1,526	NA	Director/D	
B.9508	South	SANGRUR	11KV	DS DIVN. SANGRUR	DS S/U S/D SANGRUR	D020FL20	Beed	AMR	OK	31.03.2023	AP 3Phase 3Wire				3109	1200-600/5	1,913	NA	Director/D	
B.9509	South	SANGRUR	11KV	DS DIVN. SANGRUR	DS S/U S/D SANGRUR	D020FL06	JHEOUR MAIRA	NON AMR	OK	31.03.2023	AP 3Phase 3Wire				8223391	1200-600/5	1,981	NA	Director/D	
B.9510	South	SANGRUR	11KV	DS DIVN. SANGRUR	DS S/U S/D SANGRUR	D020FL02	MILK PLANT	AMR	OK	31.03.2023	Category 1				7336394	900-450/5	2,244	NA	Director/D	
B.9511	South	SANGRUR	11KV	DS DIVN. SANGRUR	DS S/U S/D SANGRUR	D020FL18	11 kv Ballan 1	AMR	OK	31.03.2023	AP 3Phase 3Wire				9534584	1200-600/5	2,413	NA	Director/D	
B.9512	South	SANGRUR	11KV	DS DIVN. SANGRUR	DS S/U S/D SANGRUR	D020FL17	HOTIAR	NON AMR	OK	31.03.2023	AP 3Phase 3Wire				9154408	1200-600/5	2,410	NA	Director/D	
B.9513	South	SANGRUR	11KV	DS DIVN. SANGRUR	DS S/U S/D SANGRUR	D020FL07	SANGRUR AGRO	AMR	OK	31.03.2023	Category 4				20686619	1200-600/5	2,613	NA	Director/D	
B.9514	South	SANGRUR	11KV	DS DIVN. SANGRUR	DS S/U S/D SANGRUR	D020FL14	MEHLAN ROAD	AMR	OK	31.03.2023	Category 2				2068598	900-450/5	2,719	NA	Director/D	
B.9515	South	SANGRUR	11KV	DS DIVN. SANGRUR	DS S/U S/D SANGRUR	D020FL09	KHURANA	AMR	OK	31.03.2023	AP 3Phase 3Wire				2067724	900-450/5	2,969	NA	Director/D	
B.9516	South	SANGRUR	11KV	DS DIVN. SANGRUR	DS S/U S/D SANGRUR	D020FL16	THALESAN	AMR	OK	31.03.2023	AP 3Phase 3Wire				9154437	900-450/5	3,276	NA	Director/D	
B.9517	South	SANGRUR	11KV	DS DIVN. SANGRUR	DS S/U S/D SANGRUR	D020FL01	MANGWAL	AMR	OK	31.03.2023	AP 3Phase 3Wire				7042838	1200-800/5	3,645	NA	Director/D	
B.9518	South	SANGRUR	11KV	DS DIVN. SANGRUR	DS S/U S/D SANGRUR	D020FL04	RUPA HARI	AMR	OK	31.03.2023	AP 3Phase 3Wire				6740760	900-450/5	3,802	NA	Director/D	
B.9519	South	SANGRUR	11KV	DS DIVN. SANGRUR	DS S/U S/D SANGRUR	D020FL08	SOHAN	AMR	OK	31.03.2023	Category 5-UPS				2067768	900-450/5	3,815	NA	Director/D	
B.9520	South	SANGRUR	11KV	DS DIVN. SANGRUR	DS S/U S/D SANGRUR	D020FL15	HARIPURA	AMR	OK	31.03.2023	Category 1				2068368	1200-600/5	8,821	NA	Director/D	
B.9521	South	SANGRUR	11KV	DS DIVN. SANGRUR	DS S/U S/D SANGRUR	D020FL04	NANKANA SAHIB	AMR	OK	31.03.2023	Category 1				2068521	900-450/5	10,719	NA	Director/D	
B.9522	South	SANGRUR	11KV	DS DIVN. SANGRUR	DS S/U S/D SANGRUR	X239FL02	33 kv Colony Sangur	AMR	OK	31.03.2023	Category 1				198952	1200/577/1-1-1	0,114	NA	Director/D	
B.9523	South	SANGRUR	11KV	DS DIVN. SANGRUR	DS S/U S/D SANGRUR	X239FL04	RANJOUR SANGUR	AMR	OK	31.03.2023	Category 1				52396	1200/577/1-1-1	5,166	NA	Director/D	
B.9524	South	SANGRUR	11KV	DS DIVN. SANGRUR	DS S/U S/D SANGRUR	X239FL05	Jeevan Nagar sohan	AMR	OK	31.03.2023	Category 1				197916	1200/577/1-1-1	5,915	NA	Director/D	
B.9525	South	SANGRUR	11KV	DS DIVN. SANGRUR	DS S/U S/D SANGRUR	D020FL11	BHAI GURDASS	AMR	OK	31.03.2023	Category 1				2068661	1200/577/1-1-1	0,723	NA	Director/D	
B.9526	South	SANGRUR	11KV	DS DIVN. SANGRUR	DS S/U S/D SANGRUR	D020FL29	BABA SIDH (AP)	AMR	OK	31.03.2023	AP 3Phase 3Wire				5718	1200/577/1-1-1	1,061	NA	Director/D	
B.9527	South	SANGRUR	11KV	DS DIVN. SANGRUR	DS S/U S/D SANGRUR	D020FL21	Bhindran-2	AMR	OK	31.03.2023	AP 3Phase 3Wire				37184	1200-600/5	1,183	NA	Director/D	
B.9528	South	SANGRUR	11KV	DS DIVN. SANGRUR	DS S/U S/D SANGRUR	D020FL28	DEBA TWIDHA (AP)	AMR	OK	31.03.2023	AP 3Phase 3Wire				5701	1200-600/5	1,279	NA	Director/D	
B.9529	South	SANGRUR	11KV	DS DIVN. SANGRUR	DS S/U S/D SANGRUR	D020FL04	RUPA HARI	AMR	OK	31.03.2023	AP 3Phase 3Wire				8223959	900-450/5	1,967	NA	Director/D	
B.9530	South	SANGRUR	11KV	DS DIVN. SANGRUR	DS S/U S/D SANGRUR	D020FL27	Baba Pothi wala	AMR	OK	31.03.2023	AP 3Phase 3Wire				37230	1200/577/1-1-1	2,137	NA	Director/D	
B.9531	South	SANGRUR	11KV	DS DIVN. SANGRUR	DS S/U S/D SANGRUR	D020FL22	Balian 2	AMR	OK	31.03.2023	AP 3Phase 3Wire				37168	1200-600/5	2,202	NA	Director/D	
B.9532	South	SANGRUR	11KV	DS DIVN. SANGRUR	DS S/U S/D SANGRUR	D020FL12	GHRABAN	AMR	OK	31.03.2023	AP 3Phase 3Wire				8223846	1200/577/1-1-1	2,240	NA	Director/D	
B.9533	South	SANGRUR	11KV	DS DIVN. SANGRUR	DS S/U S/D SANGRUR	D020FL06	KALOU DI	AMR	OK	31.03.2023	AP 3Phase 3Wire				37166	1200-600/5	2,355	NA	Director/D	
B.9534	South	SANGRUR	11KV	DS DIVN. SANGRUR	DS S/U S/D SANGRUR	D020FL09	SARON 2	AMR	OK	31.03.2023	AP 3Phase 3Wire				8220348	1200-600/5	2,507	NA	Director/D	
B.9535	South	SANGRUR	11KV	DS DIVN. SANGRUR	DS S/U S/D SANGRUR	D020FL07	BHINDRAN	AMR	OK	31.03.2023	AP 3Phase 3Wire				37185	1200-600/5	2,578	NA	Director/D	
B.9536	South	SANGRUR	11KV	DS DIVN. SANGRUR	DS S/U S/D SANGRUR	D020FL03	BALIAM 1	AMR	OK	31.03.2023	AP 3Phase 3Wire				37211	1200-600/5	2,692	NA	Director/D	
B.9537	South	SANGRUR	11KV	DS DIVN. SANGRUR	DS S/U S/D SANGRUR	D020FL18	Rupaher 2	AMR	OK	31.03.2023	AP 3Phase 3Wire				8222837	1200-600/5	2,984	NA	Director/D	
B.9538	South	SANGRUR	11KV	DS DIVN. SANGRUR	DS S/U S/D SANGRUR	D020FL19	Fatehgarh Chhanna	AMR	OK	31.03.2023	Category 5-UPS				37210	1200/577/1-1-1	7,524	NA	Director/D	
B.9539	South	SANGRUR	11KV	DS DIVN. SANGRUR	DS S/U S/D SANGRUR	D020FL11	LADI	Not available	OK	31.03.2023	Category 5-UPS				8222450	1200-600/5	9,468	NA	Director/D	
B.9540	South	SANGRUR	11KV	DS DIVN. SANGRUR	DS S/U S/D SANGRUR	D020FL09	MILK PLANT	Not available	OK	31.03.2023	Category 4				Not available	Not available	1,477	NA	Director/D	
B.																				

S.No	Zone	Circle	Voltage Level (kVA)	Division (kVA)	Sub-Division (kVA)	Feeder ID	Feeder Name	Feeder Metering Status (Metered/unmetered/AMR/AMI)	Status of Meter (Functional/Non-Functional)	Metering Date (Date of last actual meter reading/communication)	Feeder Type (Agr/Industrial/Mixed)	Status of Communication			Period from 01.04.2021 to 31.03.2022				Sales	Remarks (Source of data)
												% data received through automatically if feeder AMR/AMI	Number of hours when meter was unable to communicate in overall	Total Number of hours in the period	Meter S.No	CT/PT ratio	Import (kWh)	Export (kWh)		
B.9573	South	SANGRUR	11KV	DS S/U DIVN. SUNAM	LEDS CITY S/D LEHRAGAGA	0230FL14	Kamred Attar Singh	AMR	OK	31.03.2023	AP 3Phase 3Wire				95801-20000	900-450/577/1-1-1	1,780	NA	Director/D	
B.9574	South	SANGRUR	11KV	DS S/U DIVN. SUNAM	LEDS CITY S/D LEHRAGAGA	0230FL01	SANGATPURA	AMR	OK	31.03.2023	AP 3Phase 3Wire				33451	900-450/577/1-1-1	1,783	NA	Director/D	
B.9575	South	SANGRUR	11KV	DS S/U DIVN. SUNAM	LEDS CITY S/D LEHRAGAGA	0230FL09	Balwani Singh	AMR	OK	31.03.2023	AP 3Phase 3Wire				11117060	900-450/577-1-1	1,828	NA	Director/D	
B.9576	South	SANGRUR	11KV	DS S/U DIVN. SUNAM	LEDS CITY S/D LEHRAGAGA	0230FL11	Gurleen C-2	NON AMR	OK	31.03.2023	Category 1				9295689	900-450/577-1-1	1,885	NA	Director/D	
B.9577	South	SANGRUR	11KV	DS S/U DIVN. SUNAM	LEDS CITY S/D LEHRAGAGA	0230FL12	GAGA	AMR	OK	31.03.2023	AP 3Phase 3Wire				11117060	900-450/577-1-1	2,067	NA	Director/D	
B.9578	South	SANGRUR	11KV	DS S/U DIVN. SUNAM	LEDS CITY S/D LEHRAGAGA	0230FL06	Dashmesh Nager	AMR	OK	31.03.2023	AP 3Phase 3Wire				11116809	900-450/577/1-1-1	2,471	NA	Director/D	
B.9579	South	SANGRUR	11KV	DS S/U DIVN. SUNAM	LEDS CITY S/D LEHRAGAGA	0230FL07	Rethakera III	AMR	OK	31.03.2023	AP 3Phase 3Wire				7336833	900-450/577/1-1-1	2,562	NA	Director/D	
B.9580	South	SANGRUR	11KV	DS S/U DIVN. SUNAM	LEDS CITY S/D LEHRAGAGA	0230FL08	Gidrani Ap	AMR	OK	31.03.2023	AP 3Phase 3Wire				33619	900-450/577/1-1-1	2,648	NA	Director/D	
B.9581	South	SANGRUR	11KV	DS S/U DIVN. SUNAM	LEDS CITY S/D LEHRAGAGA	0230FL10	Kohangan Road	AMR	OK	31.03.2023	AP 3Phase 3Wire				7336833	900-450/577-1-1	3,305	NA	Director/D	
B.9582	South	SANGRUR	11KV	DS S/U DIVN. SUNAM	LEDS CITY S/D LEHRAGAGA	0230FL04	HARYJU	AMR	OK	31.03.2023	AP 3Phase 3Wire				7039575	900-450/577-1-1	3,164	NA	Director/D	
B.9583	South	SANGRUR	11KV	DS S/U DIVN. SUNAM	LEDS CITY S/D LEHRAGAGA	0230FL02	DASKA	AMR	OK	31.03.2023	AP 3Phase 3Wire				7336859	900-450/577-1-1	3,212	NA	Director/D	
B.9584	South	SANGRUR	11KV	DS S/U DIVN. SUNAM	LEDS CITY S/D LEHRAGAGA	0230FL03	Haryou UPS	AMR	OK	31.03.2023	Category 5-UPS				5437689	900-450/577-1-1	10,731	NA	Director/D	
B.9585	South	SANGRUR	11KV	DS S/U DIVN. SUNAM	LEDS CITY S/D LEHRAGAGA	0230FL17	LITT	AMR	OK	31.03.2023	AP 3Phase 3Wire				5940	900-450/577-1-1	0,253	NA	Director/D	
B.9586	South	SANGRUR	11KV	DS S/U DIVN. SUNAM	LEDS CITY S/D LEHRAGAGA	0230FL13	Attar Singh	AMR	OK	31.03.2023	AP 3Phase 3Wire				23240	900-450/577-1-1	1,969	NA	Director/D	
B.9587	South	SANGRUR	11KV	DS S/U DIVN. SUNAM	LEDS CITY S/D LEHRAGAGA	0230FL14	Baba Pars Ram	AMR	OK	31.03.2023	AP 3Phase 3Wire				23541	900-450/577-1-1	1,977	NA	Director/D	
B.9588	South	SANGRUR	11KV	DS S/U DIVN. SUNAM	LEDS CITY S/D LEHRAGAGA	0230FL07	FATHESARH	AMR	OK	31.03.2023	AP 3Phase 3Wire				9140914	1200-600/577-1-1	2,397	NA	Director/D	
B.9589	South	SANGRUR	11KV	DS S/U DIVN. SUNAM	LEDS CITY S/D LEHRAGAGA	0230FL15	Falera	AMR	OK	31.03.2023	AP 3Phase 3Wire				8222584	1200-600/577-1-1	2,517	NA	Director/D	
B.9590	South	SANGRUR	11KV	DS S/U DIVN. SUNAM	LEDS CITY S/D LEHRAGAGA	0230FL05	Fatehgarh ups	AMR	OK	31.03.2023	Category 5-UPS				10281298	1200-600/577-1-1	6,547	NA	Director/D	
B.9591	South	SANGRUR	11KV	DS S/U DIVN. SUNAM	LEDS CITY S/D LEHRAGAGA	0230FL12	G/S/S Lehra	AMR	OK	31.03.2023	Category 1				5295599	1200-600/577-1-1	0,012	NA	Director/D	
B.9592	South	SANGRUR	11KV	DS S/U DIVN. SUNAM	LEDS CITY S/D LEHRAGAGA	0230FL05	WINDMAR	AMR	OK	31.03.2023	Category 5-UPS				5740809	900-450/577-1-1	2,435	NA	Director/D	
B.9593	South	SANGRUR	11KV	DS S/U DIVN. SUNAM	LEDS CITY S/D LEHRAGAGA	0230FL04	KOTBA	AMR	OK	31.03.2023	AP 3Phase 3Wire				6027253	1200-600/577-1-1	2,594	NA	Director/D	
B.9594	South	SANGRUR	11KV	DS S/U DIVN. SUNAM	LEDS CITY S/D LEHRAGAGA	0230FL13	Baba Masar Ram	AMR	OK	31.03.2023	Category 1				15193900	1200-600/577-1-1	4,082	NA	Director/D	
B.9595	South	SANGRUR	11KV	DS S/U DIVN. SUNAM	LEDS CITY S/D LEHRAGAGA	0230FL03	CITY LEHRA	AMR	OK	31.03.2023	Category 1				8222538	1200-600/577-1-1	8,350	NA	Director/D	
B.9596	South	SANGRUR	11KV	DS S/U DIVN. SUNAM	LEDS CITY S/D LEHRAGAGA	0230FL10	Sunam Road	AMR	OK	31.03.2023	Category 1				8222470	1200-600/577-1-1	8,603	NA	Director/D	
B.9597	South	SANGRUR	11KV	DS S/U DIVN. SUNAM	LEDS CITY S/D LEHRAGAGA	0230FL14	hospital Road	AMR	OK	31.03.2023	Category 1				2026173	900-450/577-1-1	8,893	NA	Director/D	
B.9598	South	SANGRUR	11KV	DS S/U DIVN. SUNAM	LEDS CITY S/D LEHRAGAGA	0230FL06	24 HRS. CHANGALIWALA	NON AMR	OK	31.03.2023	Category 5-UPS				8223047	900-450/577-1-1	11,595	NA	Director/D	
B.9599	South	SANGRUR	11KV	DS S/U DIVN. SUNAM	LEDS S/D BANGAN	X232FL04	Akali Phula Singh	NON AMR	OK	31.03.2023	AP 3Phase 3Wire				37153	900-450/577/1-1-1	2,022	NA	Director/D	
B.9600	South	SANGRUR	11KV	DS S/U DIVN. SUNAM	LEDS S/D BANGAN	X232FL05	Delha Sihan	AMR	OK	31.03.2023	AP 3Phase 3Wire				37159	900-450/577/1-1-1	2,418	NA	Director/D	
B.9601	South	SANGRUR	11KV	DS S/U DIVN. SUNAM	LEDS S/D BANGAN	X232FL02	New Bushera	AMR	OK	31.03.2023	AP 3Phase 3Wire				24306	1200/577/1-1-1	1,416	NA	Director/D	
B.9602	South	SANGRUR	11KV	DS S/U DIVN. SUNAM	LEDS S/D BANGAN	X232FL08	Gugga Marhi	AMR	OK	31.03.2023	AP 3Phase 3Wire				6609	1200/577/1-1-1	1,447	NA	Director/D	
B.9603	South	SANGRUR	11KV	DS S/U DIVN. SUNAM	LEDS S/D BANGAN	X232FL09	DEHA BEAS	AMR	OK	31.03.2023	AP 3Phase 3Wire				5	1200/577/1-1-1	1,568	NA	Director/D	
B.9604	South	SANGRUR	11KV	DS S/U DIVN. SUNAM	LEDS S/D BANGAN	X232FL07	Deva Duttan Ap	AMR	OK	31.03.2023	AP 3Phase 3Wire				24285	1200/577/1-1-1	1,894	NA	Director/D	
B.9605	South	SANGRUR	11KV	DS S/U DIVN. SUNAM	LEDS S/D BANGAN	X232FL04	Bhunder Bhaini	AMR	OK	31.03.2023	AP 3Phase 3Wire				24385	1200/577/1-1-1	2,054	NA	Director/D	
B.9606	South	SANGRUR	11KV	DS S/U DIVN. SUNAM	LEDS S/D BANGAN	X232FL03	Mandvi Road	AMR	OK	31.03.2023	AP 3Phase 3Wire				24290	1200/577/1-1-1	2,164	NA	Director/D	
B.9607	South	SANGRUR	11KV	DS S/U DIVN. SUNAM	LEDS S/D BANGAN	X232FL05	Bhathan	AMR	OK	31.03.2023	AP 3Phase 3Wire				24323	1200/577/1-1-1	2,527	NA	Director/D	
B.9608	South	SANGRUR	11KV	DS S/U DIVN. SUNAM	LEDS S/D BANGAN	X232FL01	Hamirgarh	AMR	OK	31.03.2023	AP 3Phase 3Wire				24400	1200/577/1-1-1	2,662	NA	Director/D	
B.9609	South	SANGRUR	11KV	DS S/U DIVN. SUNAM	LEDS S/D BANGAN	X232FL06	Hamirgarh City	AMR	OK	31.03.2023	Category 1				24293	1200/577/1-1-1	5,181	NA	Director/D	
B.9610	South	SANGRUR	11KV	DS S/U DIVN. SUNAM	LEDS S/D BANGAN	X232FL19	SHERGARH NEW	AMR	OK	31.03.2023	AP 3Phase 3Wire				8223166	1200-600/577-1-1	1,579	NA	Director/D	
B.9611	South	SANGRUR	11KV	DS S/U DIVN. SUNAM	LEDS S/D BANGAN	0232FL17	Rajalheri	AMR	OK	31.03.2023	AP 3Phase 3Wire				8223168	900-450/577-1-1	2,066	NA	Director/D	
B.9612	South	SANGRUR	11KV	DS S/U DIVN. SUNAM	LEDS S/D BANGAN	0232FL13	Hamirgarh B	AMR	OK	31.03.2023	AP 3Phase 3Wire				8223166	1200-600/577-1-1	2,158	NA	Director/D	
B.9613	South	SANGRUR	11KV	DS S/U DIVN. SUNAM	LEDS S/D BANGAN	0232FL08	BUSHERA	AMR	OK	31.03.2023	AP 3Phase 3Wire				8223169	900-450/577-1-1	2,357	NA	Director/D	
B.9614	South	SANGRUR	11KV	DS S/U DIVN. SUNAM	LEDS S/D BANGAN	0232FL01	SHERGARH	AMR	OK	31.03.2023	AP 3Phase 3Wire				273797	1200-600/577-1-1	2,568	NA	Director/D	
B.9615	South	SANGRUR	11KV	DS S/U DIVN. SUNAM	LEDS S/D BANGAN	0232FL15	MERI (NEW)	AMR	OK	31.03.2023	Category 1				8223144	900-450/577-1-1	2,626	NA	Director/D	
B.9616	South	SANGRUR	11KV	DS S/U DIVN. SUNAM	LEDS S/D BANGAN	0232FL16	bangs C-1	AMR	OK	31.03.2023	Category 1				23452	900-450/577-1-1	2,910	NA	Director/D	
B.9617	South	SANGRUR	11KV	DS S/U DIVN. SUNAM	LEDS S/D BANGAN	0232FL03	THERI	AMR	OK	31.03.2023	AP 3Phase 3Wire				8223168	900-450/577-1-1	2,947	NA	Director/D	
B.9618	South	SANGRUR	11KV	DS S/U DIVN. SUNAM	LEDS S/D BANGAN	0232FL07	DUDIAN	AMR	OK	31.03.2023	AP 3Phase 3Wire				10273766	1200-600/577-1-1	3,081	NA	Director/D	
B.9619	South	SANGRUR	11KV	DS S/U DIVN. SUNAM	LEDS S/D BANGAN	0232FL02	24 BANGAN	AMR	OK	31.03.2023	Category 5-UPS				8223552	900-450/577-1-1	10,949	NA	Director/D	
B.9620	South	SANGRUR	11KV	DS S/U DIVN. SUNAM	LEDS S/D BANGAN	0230FL13	Baba Pars Ram	AMR	OK	31.03.2023	AP 3Phase 3Wire				2346613	900-450/577-1-1	1,306	NA	Director/D	
B.9621	South	SANGRUR	11KV	DS S/U DIVN. SUNAM	LEDS S/D BANGAN	0246FL03	DHINDA	AMR	OK	31.03.2023	AP 3Phase 3Wire				11116815	900-450/577/1-1-1	1,979	NA	Director/D	
B.9622	South	SANGRUR	11KV	DS S/U DIVN. SUNAM	LEDS S/D BANGAN	0246FL05	Peer Kartarpur	AMR	OK	31.03.2023	AP 3Phase 3Wire				11116815	900-450/577/1-1-1	2,193	NA	Director/D	
B.9623	South	SANGRUR	11KV	DS S/U DIVN. SUNAM	LEDS S/D BANGAN	0246FL10	DUDIAN 2	AMR	OK	31.03.2023	AP 3Phase 3Wire				8223648	900-450/577-1-1	2,251	NA	Director/D	
B.9624	South	SANGRUR	11KV	DS S/U DIVN. SUNAM	LEDS S/D BANGAN	0246FL09	BHULTA KHURAD	AMR	OK	31.03.2023	AP 3Phase 3Wire				10288313	900-450/577/1-1-1	3,969	NA	Director/D	
B.9625	South	SANGRUR	11KV	DS S/U DIVN. SUNAM	LEDS S/D BANGAN	0246FL14	DEHA UPS	AMR	OK	31.03.2023	Category 5-UPS				11117308	900-450/577/1-1-1	11,563	NA	Director/D	
B.9626	South	SANGRUR	11KV	DS S/U DIVN. SUNAM	LEDS S/D BANGAN	0233FL19	DEHARA	AMR	OK	31.03.2023	AP 3Phase 3Wire				8223167	900-450/577-1-1	1,745	NA	Director/D	
B.9627	South	SANGRUR	11KV	DS S/U DIVN. SUNAM	LEDS S/D BANGAN	0233FL11	CHANDU	AMR	OK	31.03.2023	AP 3Phase 3Wire				6669539	900-450/577-1-1	3,160	NA	Director/D	
B.9628	South	SANGRUR	11KV	DS S/U DIVN. SUNAM	LEDS S/D BANGAN	0233FL12	New Gaggar	AMR	OK	31.03.2023	AP 3Phase 3Wire				11117081	900-450/577-1-1	3,723	NA	Director/D	
B.9629	South	SANGRUR	11KV	DS S/U DIVN. SUNAM	LEDS S/D BANGAN	0233FL04	MANDVI RURAL	AMR	OK	31.03.2023	AP 3Phase 3Wire				6679884	900-450/577-1-1	3,776	NA	Director/D	
B.9630	South	SANGRUR	11KV	DS S/U DIVN. SUNAM	LEDS S/D BANGAN	0233FL15	Chandu Ups	AMR	OK	31.03.2023	Category 5-UPS				11116964	900-450/577-1-1	5,848	NA	Director/D	
B.9631	South	SANGRUR	11KV	DS S/U DIVN. SUNAM	LEDS S/D BANGAN	0233FL13	MANDVI CITY	AMR	OK	31.03.2023	Category 1				8223171	900-450/577-1-1	7,361	NA	Director/D	
B.9632	South	SANGRUR	11KV	DS S/U DIVN. SUNAM	LEDS S/D BANGAN	0233FL13	Hamirgarh	AMR	OK	31.03.2023	AP 3Phase 3Wire				8223171	1200-600/577-1-1	2,047	NA	Director/D	
B.9633	South	SANGRUR	11KV	DS S/U DIVN. SUNAM	LEDS S/D BANGAN	0233FL10	SURJANBHANI	AMR	OK	31.03.2023	AP 3Phase 3Wire				8223656	1200-600/577-1-1	4,264	NA	Director/D	
B.9634	South	SANGRUR	11KV	DS S/U DIVN. SUNAM	LEDS S/D BANGAN	0233FL03	DEHA	AMR	OK	31.03.2023	AP 3Phase 3Wire				8223660	1200-600/577-1-1	4,617	NA	Director/D	
B.9635	South	SANGRUR	11KV	DS S/U DIVN. SUNAM	LEDS S/D BANGAN	0233FL16	24 HRS. HAMIRGARH	AMR	OK	31.03.2023	Category 5-UPS				5437726	1200-600/577-1-1	7,644	NA	Director/D	
B.9636	South	SANGRUR	11KV	DS S/U DIVN. SUNAM	LEDS S/D MOONAK	X232FL12	Grid 5/Sa Balran													

S.No	Zone	Circle	Voltage Level (kVA)	Division (kVA)	Sub-Division (kVA)	Feeder ID	Feeder Name	Feeder Metering Status (Metred/unmetred/AMR/AMI)	Status of Meter (Functional/Non-functional)	Metering Date	Date of last actual meter reading/communication	Feeder Type (Agr/Industrial/Mixed)	Status of Communication			Period from 01.04.2021 to 31.03.2022				Sales	Remarks (Source of data)
													% data received through automatically if feeder AMR/AMI	Number of hours when meter was unable to communicate in overall	Total Number of hours in the period	Meter S.No	CT/PT ratio	Import (kWh)	Export (kWh)		
B.9670	South	SANGRUR	11KV	DS S/U DIVN. SUNAM	LEDS S/D MOONAK	D233FL01	KHOHAR	AMR	OK	31.03.2023		AP 3Phase 3Wire				9524604	900-450/5	3.212	NA	Director/D	
B.9671	South	SANGRUR	11KV	DS S/U DIVN. SUNAM	LEDS S/D MOONAK	D233FL07	24 HRS. MAHASINGHWALA	AMR	OK	31.03.2023		Category 5-UPS				7365995	900-450/5	5.324	NA	Director/D	
B.9672	South	SANGRUR	11KV	DS S/U DIVN. SUNAM	LEDS S/D MOONAK	D233FL20	GRIH S/ MOONAK	AMR	OK	31.03.2023		Category 1					1200-600/5	0.012	NA	Director/D	
B.9673	South	SANGRUR	11KV	DS S/U DIVN. SUNAM	LEDS S/D MOONAK	D233FL12	FILLOD AP	AMR	OK	31.03.2023		AP 3Phase 3Wire				8223174	1200-600/5	1.618	NA	Director/D	
B.9674	South	SANGRUR	11KV	DS S/U DIVN. SUNAM	LEDS S/D MOONAK	D233FL11	BALRAN	AMR	OK	31.03.2023		AP 3Phase 3Wire				8223659	1200-600/5	2.620	NA	Director/D	
B.9675	South	SANGRUR	11KV	DS S/U DIVN. SUNAM	LEDS S/D MOONAK	D233FL09	Rathee Krishan+(handa branch)p	AMR	OK	31.03.2023		AP 3Phase 3Wire				8223771	1200-600/5	3.468	NA	Director/D	
B.9676	South	SANGRUR	11KV	DS S/U DIVN. SUNAM	LEDS S/D MOONAK	D233FL06	HANDAKudrni	AMR	OK	31.03.2023		AP 3Phase 3Wire				8223657	1200-600/5	3.841	NA	Director/D	
B.9677	South	SANGRUR	11KV	DS S/U DIVN. SUNAM	LEDS S/D MOONAK	D233FL05	MAKORID SAHIB(new+old)	AMR	OK	31.03.2023		AP 3Phase 3Wire				5341623	1200-600/5	4.123	NA	Director/D	
B.9678	South	SANGRUR	11KV	DS S/U DIVN. SUNAM	LEDS S/D MOONAK	D233FL04	KARALI(new+manu)	AMR	OK	31.03.2023		AP 3Phase 3Wire				8223658	1200-600/5	4.265	NA	Director/D	
B.9679	South	SANGRUR	11KV	DS S/U DIVN. SUNAM	LEDS S/D MOONAK	D233FL14	CHULAR	AMR	OK	31.03.2023		AP 3Phase 3Wire				8223172	1200-600/5	6.549	NA	Director/D	
B.9680	South	SANGRUR	11KV	DS S/U DIVN. SUNAM	LEDS S/D MOONAK	D233FL15	PAPRA(main+branch)	AMR	OK	31.03.2023		AP 3Phase 3Wire				8223175	1200-600/5	4.707	NA	Director/D	
B.9681	South	SANGRUR	11KV	DS S/U DIVN. SUNAM	LEDS S/D MOONAK	D233FL17	BALAKNATH	NON AMR	OK	31.03.2023		Category 1				13190504	1200-600/5	6.698	NA	Director/D	
B.9682	South	SANGRUR	11KV	DS S/U DIVN. SUNAM	LEDS S/D MOONAK	D233FL19	Tohana Road	NON AMR	OK	31.03.2023		Category 1				1122	1200-600/5	9.300	NA	Director/D	
B.9683	South	SANGRUR	11KV	DS S/U DIVN. SUNAM	LEDS S/D MOONAK	D233FL01	24 HRS. BALRAN	AMR	OK	31.03.2023		Category 5-UPS				8223277	1200-600/5	13.473	NA	Director/D	
B.9684	South	SANGRUR	11KV	DS S/U DIVN. SUNAM	LEDS S/D MOONAK	D233FL08	MOONAK CITY	NON AMR	OK	31.03.2023		Category 1				7042940	1200-600/5	14.908	NA	Director/D	
B.9685	South	SANGRUR	11KV	DS S/U DIVN. SUNAM	LEDS S/U S/D LEHRAGAGA	X233FL08	BHAN GIR	AMR	OK	31.03.2023		AP 3Phase 3Wire				0	900-450/577/1-1	2.405	NA	Director/D	
B.9686	South	SANGRUR	11KV	DS S/U DIVN. SUNAM	LEDS S/U S/D LEHRAGAGA	X233FL07	RANGLI SHAH	AMR	OK	31.03.2023		AP 3Phase 3Wire				65782	900-450/577/1-1	2.626	NA	Director/D	
B.9687	South	SANGRUR	11KV	DS S/U DIVN. SUNAM	LEDS S/U S/D LEHRAGAGA	X233FL09	UPS Lehal Kalan	AMR	OK	31.03.2023		Category 5-UPS				38855	900-450/577/1-1	6.654	NA	Director/D	
B.9688	South	SANGRUR	11KV	DS S/U DIVN. SUNAM	LEDS S/U S/D LEHRAGAGA	D228FL16	BABA SIDH SAR	AMR	OK	31.03.2023		AP 3Phase 3Wire				15196156	1200-600/5	2.318	NA	Director/D	
B.9689	South	SANGRUR	11KV	DS S/U DIVN. SUNAM	LEDS S/U S/D LEHRAGAGA	D228FL07	SANGTIWALA	AMR	OK	31.03.2023		AP 3Phase 3Wire				5383378	1200-600/5	2.347	NA	Director/D	
B.9690	South	SANGRUR	11KV	DS S/U DIVN. SUNAM	LEDS S/U S/D LEHRAGAGA	D228FL15	GILL FEEDER	AMR	OK	31.03.2023		AP 3Phase 3Wire				15196092	1200-600/5	2.383	NA	Director/D	
B.9691	South	SANGRUR	11KV	DS S/U DIVN. SUNAM	LEDS S/U S/D LEHRAGAGA	D228FL12	NAGLA	AMR	OK	31.03.2023		AP 3Phase 3Wire				8223142	1200-600/5	2.506	NA	Director/D	
B.9692	South	SANGRUR	11KV	DS S/U DIVN. SUNAM	LEDS S/U S/D LEHRAGAGA	D228FL10	UPS SANGTIWALA	AMR	OK	31.03.2023		Category 5-UPS				6679876	1200-600/5	9.257	NA	Director/D	
B.9693	South	SANGRUR	11KV	DS S/U DIVN. SUNAM	LEDS S/U S/D LEHRAGAGA	X228FL08	SUB SATIION KHANDEBAD	AMR	OK	31.03.2023		AP 3Phase 3Wire				5877	900-450/577/1-1	0.020	NA	Director/D	
B.9694	South	SANGRUR	11KV	DS S/U DIVN. SUNAM	LEDS S/U S/D LEHRAGAGA	X228FL10	PALACE ROAD	AMR	OK	31.03.2023		AP 3Phase 3Wire				958012000	900-450/577/1-1	0.830	NA	Director/D	
B.9695	South	SANGRUR	11KV	DS S/U DIVN. SUNAM	LEDS S/U S/D LEHRAGAGA	X228FL03	GORAH TILA	AMR	OK	31.03.2023		AP 3Phase 3Wire				36949	900-450/577/1-1	1.528	NA	Director/D	
B.9696	South	SANGRUR	11KV	DS S/U DIVN. SUNAM	LEDS S/U S/D LEHRAGAGA	X228FL12	DHAB	AMR	OK	31.03.2023		AP 3Phase 3Wire				95801-20000	900-450/577/1-1	1.915	NA	Director/D	
B.9697	South	SANGRUR	11KV	DS S/U DIVN. SUNAM	LEDS S/U S/D LEHRAGAGA	X228FL02	DUGAL ROD	AMR	OK	31.03.2023		AP 3Phase 3Wire				73160196	900-450/577/1-1	2.015	NA	Director/D	
B.9698	South	SANGRUR	11KV	DS S/U DIVN. SUNAM	LEDS S/U S/D LEHRAGAGA	X228FL01	JOGI PEER	AMR	OK	31.03.2023		AP 3Phase 3Wire				36968	900-450/577/1-1	2.073	NA	Director/D	
B.9699	South	SANGRUR	11KV	DS S/U DIVN. SUNAM	LEDS S/U S/D LEHRAGAGA	X228FL11	11 KV LEHAL KHURD	AMR	OK	31.03.2023		AP 3Phase 3Wire				9646142100	900-450/577/1-1	2.218	NA	Director/D	
B.9700	South	SANGRUR	11KV	DS S/U DIVN. SUNAM	LEDS S/U S/D LEHRAGAGA	X228FL07	NATHA SHAH	AMR	OK	31.03.2023		AP 3Phase 3Wire				73163195	900-450/577/1-1	2.401	NA	Director/D	
B.9701	South	SANGRUR	11KV	DS S/U DIVN. SUNAM	LEDS S/U S/D LEHRAGAGA	X228FL09	DHINDRA ROAD	AMR	OK	31.03.2023		AP 3Phase 3Wire				34240	900-450/577/1-1	2.613	NA	Director/D	
B.9702	South	SANGRUR	11KV	DS S/U DIVN. SUNAM	LEDS S/U S/D LEHRAGAGA	X228FL05	KHAI ROD	AMR	OK	31.03.2023		AP 3Phase 3Wire				34432	900-450/577/1-1	2.789	NA	Director/D	
B.9703	South	SANGRUR	11KV	DS S/U DIVN. SUNAM	LEDS S/U S/D LEHRAGAGA	X228FL04	KHANDEBAD	AMR	OK	31.03.2023		Category 1				36959	900-450/577/1-1	3.258	NA	Director/D	
B.9704	South	SANGRUR	11KV	DS S/U DIVN. SUNAM	LEDS S/U S/D LEHRAGAGA	X228FL13	VERBIO	AMR	OK	31.03.2023		Category 4				5991	900-450/577/1-1	4.552	NA	Director/D	
B.9705	South	SANGRUR	11KV	DS S/U DIVN. SUNAM	LEDS S/U S/D LEHRAGAGA	X210FL12	SUB SATIION SEKHUWAS	AMR	OK	31.03.2023		AP 3Phase 3Wire				12345	400-200/5	0.026	NA	Director/D	
B.9706	South	SANGRUR	11KV	DS S/U DIVN. SUNAM	LEDS S/U S/D LEHRAGAGA	X210FL15	SIDHU PATTI	AMR	OK	31.03.2023		AP 3Phase 3Wire				12345	400-200/5	1.125	NA	Director/D	
B.9707	South	SANGRUR	11KV	DS S/U DIVN. SUNAM	LEDS S/U S/D LEHRAGAGA	X210FL04	GHOENAB-2	AMR	OK	31.03.2023		AP 3Phase 3Wire				10281049	900-450/5	1.471	NA	Director/D	
B.9708	South	SANGRUR	11KV	DS S/U DIVN. SUNAM	LEDS S/U S/D LEHRAGAGA	X210FL09	GEHLA PATTI	AMR	OK	31.03.2023		AP 3Phase 3Wire				12345	400-200/5	1.672	NA	Director/D	
B.9709	South	SANGRUR	11KV	DS S/U DIVN. SUNAM	LEDS S/U S/D LEHRAGAGA	X210FL14	RPODE WALA ROAD	AMR	OK	31.03.2023		AP 3Phase 3Wire				12345	400-200/5	1.712	NA	Director/D	
B.9710	South	SANGRUR	11KV	DS S/U DIVN. SUNAM	LEDS S/U S/D LEHRAGAGA	X210FL01	BHA KI PASHORE -2	AMR	OK	31.03.2023		AP 3Phase 3Wire				11117238	900-450/5	2.010	NA	Director/D	
B.9711	South	SANGRUR	11KV	DS S/U DIVN. SUNAM	LEDS S/U S/D LEHRAGAGA	X210FL02	BAGMARH	AMR	OK	31.03.2023		AP 3Phase 3Wire				10282917	900-450/5	2.120	NA	Director/D	
B.9712	South	SANGRUR	11KV	DS S/U DIVN. SUNAM	LEDS S/U S/D LEHRAGAGA	X210FL11	ROTHMAN DAS	AMR	OK	31.03.2023		AP 3Phase 3Wire				10283836	900-450/5	2.237	NA	Director/D	
B.9713	South	SANGRUR	11KV	DS S/U DIVN. SUNAM	LEDS S/U S/D LEHRAGAGA	X210FL10	TAHL DAS	AMR	OK	31.03.2023		AP 3Phase 3Wire				12345	400-200/5	2.249	NA	Director/D	
B.9714	South	SANGRUR	11KV	DS S/U DIVN. SUNAM	LEDS S/U S/D LEHRAGAGA	X210FL13	BHAI GURDAS	AMR	OK	31.03.2023		AP 3Phase 3Wire				12345	400-200/5	2.306	NA	Director/D	
B.9715	South	SANGRUR	11KV	DS S/U DIVN. SUNAM	LEDS S/U S/D LEHRAGAGA	X210FL08	SIDKAR	AMR	OK	31.03.2023		AP 3Phase 3Wire				12345	400-200/5	2.357	NA	Director/D	
B.9716	South	SANGRUR	11KV	DS S/U DIVN. SUNAM	LEDS S/U S/D LEHRAGAGA	X210FL05	SEKHUWAS CITY	AMR	OK	31.03.2023		Category 1				1028444	900-450/5	2.415	NA	Director/D	
B.9717	South	SANGRUR	11KV	DS S/U DIVN. SUNAM	LEDS S/U S/D LEHRAGAGA	X210FL06	KANDEBAD	AMR	OK	31.03.2023		AP 3Phase 3Wire				10283085	900-450/5	2.028	NA	Director/D	
B.9718	South	SANGRUR	11KV	DS S/U DIVN. SUNAM	LEDS S/U S/D LEHRAGAGA	X210FL03	SEKHUWAS	AMR	OK	31.03.2023		AP 3Phase 3Wire				10282909	900-450/5	2.482	NA	Director/D	
B.9719	South	SANGRUR	11KV	DS S/U DIVN. SUNAM	LEDS S/U S/D LEHRAGAGA	X210FL07	BHAI KE PASHOUR	AMR	OK	31.03.2023		Category 5-UPS				12345	400-200/5	11.267	NA	Director/D	
B.9720	South	SANGRUR	11KV	DS S/U DIVN. SUNAM	LEDS S/U S/D LEHRAGAGA	D246F00	SUB SATIION BHUTAL KALAN	AMR	OK	31.03.2023		AP 3Phase 3Wire				10288313	900-450/5	0.010	NA	Director/D	
B.9721	South	SANGRUR	11KV	DS S/U DIVN. SUNAM	LEDS S/U S/D LEHRAGAGA	D246FL11	BUDHIGR	AMR	OK	31.03.2023		AP 3Phase 3Wire				12092447	900-450/577/1-1	1.724	NA	Director/D	
B.9722	South	SANGRUR	11KV	DS S/U DIVN. SUNAM	LEDS S/U S/D LEHRAGAGA	D246FL07	GHOENAB	AMR	OK	31.03.2023		AP 3Phase 3Wire				2062221	900-450/5	1.755	NA	Director/D	
B.9723	South	SANGRUR	11KV	DS S/U DIVN. SUNAM	LEDS S/U S/D LEHRAGAGA	D246FL01	BARKAT	AMR	OK	31.03.2023		AP 3Phase 3Wire				2047081	900-450/5	1.827	NA	Director/D	
B.9724	South	SANGRUR	11KV	DS S/U DIVN. SUNAM	LEDS S/U S/D LEHRAGAGA	D246FL12	BARKAT	AMR	OK	31.03.2023		AP 3Phase 3Wire				12092476	900-450/577/1-1	2.127	NA	Director/D	
B.9725	South	SANGRUR	11KV	DS S/U DIVN. SUNAM	LEDS S/U S/D LEHRAGAGA	D246FL04	BHUTAL KALAN	AMR	OK	31.03.2023		AP 3Phase 3Wire				2047104	900-450/5	2.241	NA	Director/D	

S.No	Zone	Circle	Voltage Level (kVA)	Division (kVA)	Sub-Division (kVA)	Feeder Metering Status (Metered/unmetered/AMR/AMI)	Status of Meter (Functional/Non-functional)	Metering Date (Date of last actual meter reading/communication)	Feeder Type (Agr./Industrial/Mixed)	Status of Communication			Period from 01.04.2021 to 31.03.2022				Sales	Remarks (Source of data)
										% data received through automatically if feeder AMR/AMI	Number of hours when meter was unable to communicate in overall	Total Number of hours in the period	Meter S.No	CT/PT ratio	Import (kWh)	Export (kWh)		
B.9767	West	BATHINDA	11kV	DS CITY DIVN. BATHINDA	S/D GONIANA	DRL09	Gill Pati	AMR	OK	31.03.2023	AP 3Phase 3Wire	23494	1200-600/5	2,784	NA	Director/D		
B.9768	West	BATHINDA	11kV	DS CITY DIVN. BATHINDA	S/D GONIANA	DRL08	Khaii wala	NON AMR	OK	31.03.2023	AP 3Phase 3Wire	674	900-450/577/1-1	3,433	NA	Director/D		
B.9769	West	BATHINDA	11kV	DS CITY DIVN. BATHINDA	S/D GONIANA	DRH07	Khaii wala	AMR	OK	31.03.2023	Category 5-UPS	23588	1200-600/5	3,911	NA	Director/D		
B.9770	West	BATHINDA	11kV	DS CITY DIVN. BATHINDA	S/D GONIANA	D379FL11	Hot Live	NON AMR	OK	31.03.2023	Category 4	1117205	Not installed	0,480	NA	Director/D		
B.9771	West	BATHINDA	11kV	DS CITY DIVN. BATHINDA	S/D GONIANA	D379FL16	OMAXE COLONY	NON AMR	OK	31.03.2023	Category 1	73152097	Not installed	1,190	NA	Director/D		
B.9772	West	BATHINDA	11kV	DS CITY DIVN. BATHINDA	S/D GONIANA	D379FL14	Nesury 3P	NON AMR	OK	31.03.2023	AP 3Phase 3Wire	11117146	Not installed	1,489	NA	Director/D		
B.9773	West	BATHINDA	11kV	DS CITY DIVN. BATHINDA	S/D GONIANA	D379FL15	AMARGARH (A)	AMR	OK	31.03.2023	AP 3Phase 3Wire	2068740	Not installed	1,978	NA	Director/D		
B.9774	West	BATHINDA	11kV	DS CITY DIVN. BATHINDA	S/D GONIANA	D379FL06	Gill Pati	AMR	OK	31.03.2023	AP 3Phase 3Wire	8223806	Not installed	2,284	NA	Director/D		
B.9775	West	BATHINDA	11kV	DS CITY DIVN. BATHINDA	S/D GONIANA	D379FL01	MEHNA SERIA	AMR	OK	31.03.2023	AP 3Phase 3Wire	5385159	Not installed	2,820	NA	Director/D		
B.9776	West	BATHINDA	11kV	DS CITY DIVN. BATHINDA	S/D GONIANA	D379FL09	HARRAPUR	AMR	OK	31.03.2023	AP 3Phase 3Wire	9154230	Not installed	2,589	NA	Director/D		
B.9777	West	BATHINDA	11kV	DS CITY DIVN. BATHINDA	S/D GONIANA	D379FL04	AKLIA	NON AMR	OK	31.03.2023	AP 3Phase 3Wire	9154058	Not installed	2,878	NA	Director/D		
B.9778	West	BATHINDA	11kV	DS CITY DIVN. BATHINDA	S/D GONIANA	D379FL17	LAKHI JUNGLE	AMR	OK	31.03.2023	AP 3Phase 3Wire	2754	Not installed	3,126	NA	Director/D		
B.9779	West	BATHINDA	11kV	DS CITY DIVN. BATHINDA	S/D GONIANA	D379FL05	KHAIJI WALA	AMR	OK	31.03.2023	AP 3Phase 3Wire	4221019	Not installed	3,398	NA	Director/D		
B.9780	West	BATHINDA	11kV	DS CITY DIVN. BATHINDA	S/D GONIANA	D379FL02	KHEMJANA	AMR	OK	31.03.2023	AP 3Phase 3Wire	1033645	Not installed	3,622	NA	Director/D		
B.9781	West	BATHINDA	11kV	DS CITY DIVN. BATHINDA	S/D GONIANA	D379FL07	Bhokra	AMR	OK	31.03.2023	Category 1	11114545	Not installed	3,995	NA	Director/D		
B.9782	West	BATHINDA	11kV	DS CITY DIVN. BATHINDA	S/D GONIANA	D379FL12	Balshar Vinju	NON AMR	OK	31.03.2023	Category 1	2068011	Not installed	4,523	NA	Director/D		
B.9783	West	BATHINDA	11kV	DS CITY DIVN. BATHINDA	S/D GONIANA	D379FL07	11KV Gill Pati	NON AMR	OK	31.03.2023	Category 5-UPS	23760	Not installed	4,640	NA	Director/D		
B.9784	West	BATHINDA	11kV	DS CITY DIVN. BATHINDA	S/D GONIANA	D379FL13	GONIANA MANDI	AMR	OK	31.03.2023	Category 1	11117246	Not installed	9,217	NA	Director/D		
B.9785	West	BATHINDA	11kV	DS CITY DIVN. BATHINDA	S/D GONIANA	D379FL10	NEHAH WALD	NON AMR	OK	31.03.2023	Category 1	11117269	Not installed	9,877	NA	Director/D		
B.9786	West	BATHINDA	11kV	DS CITY DIVN. BATHINDA	S/D GONIANA	D379FL18	BHAI JASTA JI	AMR	OK	31.03.2023	Category 1	12395	Not installed	8,970	NA	Director/D		
B.9787	West	BATHINDA	11kV	DS CITY DIVN. BATHINDA	S/D GONIANA	D379FL08	FOCAL POINT	AMR	OK	31.03.2023	Category 5-UPS	2047163	Not installed	10,603	NA	Director/D		
B.9788	West	BATHINDA	11kV	DS CITY DIVN. BATHINDA	S/D GONIANA	D418FL18	AB COITON	AMR	OK	31.03.2023	Category 4	54321	900-450/577/1-1	0,080	NA	Director/D		
B.9789	West	BATHINDA	11kV	DS CITY DIVN. BATHINDA	S/D GONIANA	D418FL17	FOUJA SINGH	AMR	OK	31.03.2023	AP 3Phase 3Wire	111	900-450/577/1-1	1,027	NA	Director/D		
B.9790	West	BATHINDA	11kV	DS CITY DIVN. BATHINDA	S/D GONIANA	D418FL14	11 kv kaani wala	AMR	OK	31.03.2023	AP 3Phase 3Wire	1 111111+12	1200/577/1-1	1,888	NA	Director/D		
B.9791	West	BATHINDA	11kV	DS CITY DIVN. BATHINDA	S/D GONIANA	D418FL07	CHAK I EDA	AMR	OK	31.03.2023	AP 3Phase 3Wire	953488	900-450/577/1-1	2,534	NA	Director/D		
B.9792	West	BATHINDA	11kV	DS CITY DIVN. BATHINDA	S/D GONIANA	D418FL03	LEDA	AMR	OK	31.03.2023	AP 3Phase 3Wire	2041729	900-450/577/1-1	3,285	NA	Director/D		
B.9793	West	BATHINDA	11kV	DS CITY DIVN. BATHINDA	S/D GONIANA	D418FL05	Raukasar	NON AMR	OK	31.03.2023	Category 1	7336633	900-450/577/1-1	11,485	NA	Director/D		
B.9794	West	BATHINDA	11kV	DS CITY DIVN. BATHINDA	S/D GONIANA	D720FL08	11 KV KOTHE BHAGU WALA	NON AMR	OK	31.03.2023	AP 3Phase 3Wire	4687	900-450/5	1,122	NA	Director/D		
B.9795	West	BATHINDA	11kV	DS CITY DIVN. BATHINDA	S/D GONIANA	DRL11	kotha phule wala	NON AMR	OK	31.03.2023	AP 3Phase 3Wire	13190503	900-450/5	2,022	NA	Director/D		
B.9796	West	BATHINDA	11kV	DS CITY DIVN. BATHINDA	S/D GONIANA	D000FL05	BABA RODU SHAH	NON AMR	OK	31.03.2023	AP 3Phase 3Wire	123	900-450/5	2,310	NA	Director/D		
B.9797	West	BATHINDA	11kV	DS CITY DIVN. BATHINDA	S/D GONIANA	DRL12	Mehma Bhagwata	NON AMR	OK	31.03.2023	AP 3Phase 3Wire	13190539	900-450/5	2,519	NA	Director/D		
B.9798	West	BATHINDA	11kV	DS CITY DIVN. BATHINDA	S/D GONIANA	D379FL06	KOTHE CHARBI WALA	NON AMR	OK	31.03.2023	AP 3Phase 3Wire	12345	900-450/5	2,764	NA	Director/D		
B.9799	West	BATHINDA	11kV	DS CITY DIVN. BATHINDA	S/D GONIANA	DRL03	KILLI NHAJI SINGH	NON AMR	OK	31.03.2023	Category 1	12527425	900-450/5	3,990	NA	Director/D		
B.9800	West	BATHINDA	11kV	DS CITY DIVN. BATHINDA	S/D GONIANA	DRL02	BURAI MEHMA	AMR	OK	31.03.2023	Category 5-UPS	13190554	900-450/5	9,656	NA	Director/D		
B.9801	West	BATHINDA	11kV	DS CITY DIVN. BATHINDA	S/D GONIANA	D382FL10	JAITU ROAD	AMR	OK	31.03.2023	AP 3Phase 3Wire	9534413	Not installed	1,154	NA	Director/D		
B.9802	West	BATHINDA	11kV	DS CITY DIVN. BATHINDA	S/D GONIANA	D382FL12	kotha dhawan wala	NON AMR	OK	31.03.2023	AP 3Phase 3Wire	4053	900-450/577/1-1	1,405	NA	Director/D		
B.9803	West	BATHINDA	11kV	DS CITY DIVN. BATHINDA	S/D GONIANA	D382FL11	11KV Ramnara Road	NON AMR	OK	31.03.2023	AP 3Phase 3Wire	24389	Not installed	1,590	NA	Director/D		
B.9804	West	BATHINDA	11kV	DS CITY DIVN. BATHINDA	S/D GONIANA	D382FL07	Kotha warde wala	AMR	OK	31.03.2023	AP 3Phase 3Wire	2066840	Not installed	2,253	NA	Director/D		
B.9805	West	BATHINDA	11kV	DS CITY DIVN. BATHINDA	S/D GONIANA	D382FL04	KOTHE DHABAN WALE	NON AMR	OK	31.03.2023	AP 3Phase 3Wire	2066573	Not installed	2,272	NA	Director/D		
B.9806	West	BATHINDA	11kV	DS CITY DIVN. BATHINDA	S/D GONIANA	D382FL08	Bhaliana	AMR	OK	31.03.2023	AP 3Phase 3Wire	24380	900-450/577/1-1	2,650	NA	Director/D		
B.9807	West	BATHINDA	11kV	DS CITY DIVN. BATHINDA	S/D GONIANA	D382FL09	Ganga	AMR	OK	31.03.2023	AP 3Phase 3Wire	9534413	900-450/577/1-1	2,749	NA	Director/D		
B.9808	West	BATHINDA	11kV	DS CITY DIVN. BATHINDA	S/D GONIANA	D382FL05	KOTHE SANDHUAN WALE	AMR	OK	31.03.2023	AP 3Phase 3Wire	2067641	900-450/577/1-1	2,090	NA	Director/D		
B.9809	West	BATHINDA	11kV	DS CITY DIVN. BATHINDA	S/D GONIANA	D382FL01	KOTHE CHAKRI WALA	AMR	OK	31.03.2023	Category 1	9534886	Not installed	4,534	NA	Director/D		
B.9810	West	BATHINDA	11kV	DS CITY DIVN. BATHINDA	S/D GONIANA	D382FL01	ABLU	AMR	OK	31.03.2023	Category 5-UPS	2066638	Not installed	6,463	NA	Director/D		
B.9811	West	BATHINDA	11kV	DS CITY DIVN. BATHINDA	S/D GONIANA	D382FL02	KOTHE DHABAN WALE	AMR	OK	31.03.2023	Category 5-UPS	2066573	Not installed	7,832	NA	Director/D		
B.9812	West	BATHINDA	11kV	DS CITY DIVN. BATHINDA	S/D GONIANA	D70MFL05	SAINT BORE WALE	AMR	OK	31.03.2023	AP 3Phase 3Wire	4723	400-200/5-5	1,634	NA	Director/D		
B.9813	West	BATHINDA	11kV	DS CITY DIVN. BATHINDA	S/D GONIANA	D379FL07	NEHAH WALA (AP)	NON AMR	OK	31.03.2023	AP 3Phase 3Wire	9568187	Not installed	2,718	NA	Director/D		
B.9814	West	BATHINDA	11kV	DS CITY DIVN. BATHINDA	S/D GONIANA	D379FL08	DEERA NAGAR	AMR	OK	31.03.2023	AP 3Phase 3Wire	9568445	Not installed	3,065	NA	Director/D		
B.9815	West	BATHINDA	11kV	DS CITY DIVN. BATHINDA	S/D GONIANA	D379FL03	DEON JBI	AMR	OK	31.03.2023	AP 3Phase 3Wire	9568119	Not installed	3,405	NA	Director/D		
B.9816	West	BATHINDA	11kV	DS CITY DIVN. BATHINDA	S/D GONIANA	D379FL06	SIVAN	Not available	OK	31.03.2023	Category 5-UPS	9568190	Not installed	11,907	NA	Director/D		
B.9817	West	BATHINDA	66kV	DS CITY DIVN. BATHINDA	S/D GONIANA	D418DL02	SPORTING 66KV	NON AMR	OK	31.03.2023	Category 4	Not available	Not available	142,875	NA	Director/D		
B.9818	West	BATHINDA	11kV	DS CITY DIVN. BATHINDA	S/D SANGAT	D000FL03	SHERGARH	NON AMR	OK	31.03.2023	AP 3Phase 3Wire	3	400-200/5-5	2,293	NA	Director/D		
B.9819	West	BATHINDA	11kV	DS CITY DIVN. BATHINDA	S/D SANGAT	D000FL01	MEHTA	NON AMR	OK	31.03.2023	Category 1	1	400-200/5-5	3,104	NA	Director/D		
B.9820	West	BATHINDA	11kV	DS CITY DIVN. BATHINDA	S/D SANGAT	D000FL02	PHURSAR SAINEWALA	NON AMR	OK	31.03.2023	AP 3Phase 3Wire	1	400-200/5-5	3,124	NA	Director/D		
B.9821	West	BATHINDA	11kV	DS CITY DIVN. BATHINDA	S/D SANGAT	D706FL04	STATION WALA	AMR	OK	31.03.2023	Category 5-UPS	1570	400-200/5-5	3,481	NA	Director/D		
B.9822	West	BATHINDA	11kV	DS CITY DIVN. BATHINDA	S/D SANGAT	D517FL06	11KV BANDI AP	AMR	OK	31.03.2023	AP 3Phase 3Wire	37122	900-450/577/1-1	3,725	NA	Director/D		
B.9823	West	BATHINDA	11kV	DS CITY DIVN. BATHINDA	S/D SANGAT	D389FL09	MASHANA	AMR	OK	31.03.2023	AP 3Phase 3Wire	7042979	Not installed	1,220	NA	Director/D		
B.9824	West	BATHINDA	11kV	DS CITY DIVN. BATHINDA	S/D SANGAT	D394FL05	TIBBA	NON AMR	OK	31.03.2023	AP 3Phase 3Wire	1569	Not installed	1,525	NA	Director/D		
B.9825	West	BATHINDA	11kV	DS CITY DIVN. BATHINDA	S/D SANGAT	D394FL06	PUR KUTHA	AMR	OK	31.03.2023	AP 3Phase 3Wire	35018	900-450/577/1-1	1,625	NA	Director/D		
B.9826	West	BATHINDA	11kV	DS CITY DIVN. BATHINDA	S/D SANGAT	D394FL04	PICCA KALAN	AMR	OK	31.03.2023	AP 3Phase 3Wire	7336370	Not installed	2,477	NA	Director/D		
B.9827	West	BATHINDA	11kV	DS CITY DIVN. BATHINDA	S/D SANGAT	D394FL02	JASSI	AMR	OK	31.03.2023	Category 5-UPS	7042948	Not installed	5,617	NA	Director/D		
B.9828	West	BATHINDA	11kV	DS CITY DIVN. BATHINDA	S/D SANGAT	D394FL03	PICCA KALAN	AMR	OK	31.03.2023	Category 1	7042963	Not installed	6,782	NA	Director/D		
B.9829	West	BATHINDA	11kV	DS CITY DIVN. BATHINDA	S/D SANGAT	D389FL03	NARUANA	AMR	OK	31.03.2023	AP 3Phase 3Wire	8223511	Not installed	2,439	NA	Director/D		
B.9830	West	BATHINDA	11kV	DS CITY DIVN. BATHINDA	S/D SANGAT	D489FL09	11 kv Jai Singh Wala	AMR	OK	31.03.2023	AP 3Phase 3Wire	2066433	Not installed	2,912	NA	Director/D		
B.9831	West	BATHINDA	11kV	DS CITY DIVN. BATHINDA	S/D SANGAT	D389FL08	ADRAH NAGAR	NON AMR	OK	31.03.2023	Category 5-UPS	6740971	Not installed	9,520	NA	Director/D		

S.No	Zone	Circle	Voltage Level (kVA)	Division (kVA)	Sub-Division (kVA)	Feeder ID	Feeder Name	Feeder Metering Status (Metered/unmetered/AMR/AMI)	Status of Meter (Functional/Non-Functional)	Metering Date	Date of last actual meter reading/communication	Feeder Type (Agr./Industrial/Mixed)	Status of Communication			Period from 01.04.2021 to 31.03.2022				Sales	Remarks (Source of data)
													% data received through automatically if feeder AMR/AMI	Number of hours when meter was unable to communicate in overall	Total Number of hours in the period	Meter S.No	CT/PT ratio	Import (kWh)	Export (kWh)		
B.9864	West	BATHINDA	11KV	DS CITY DIVN. BATHINDA	DS S/D Tech-1 Bathinda	0722FL05	DANA MANDI	NON AMR	OK	31.03.2023		AP 3Phase 3Wire				15194776	900-450/577/1-1-1	2,043	NA	Director/D	
B.9865	West	BATHINDA	11KV	DS CITY DIVN. BATHINDA	DS S/D Tech-1 Bathinda	D-Fl02	HARRANGPURA	NON AMR	OK	31.03.2023		AP 3Phase 3Wire				13190580	1200-600/5	2,544	NA	Director/D	
B.9866	West	BATHINDA	11KV	DS CITY DIVN. BATHINDA	DS S/D Tech-1 Bathinda	0722FL11	11 KV JOGANAND	NON AMR	OK	31.03.2023		AP 3Phase 3Wire				12345	900-450/577/1-1-1	2,604	NA	Director/D	
B.9867	West	BATHINDA	11KV	DS CITY DIVN. BATHINDA	DS S/D Tech-1 Bathinda	D-Fl03	GOPIBARA	NON AMR	OK	31.03.2023		AP 3Phase 3Wire				13190581	1200-600/5	2,746	NA	Director/D	
B.9868	West	BATHINDA	11KV	DS CITY DIVN. BATHINDA	DS S/D Tech-1 Bathinda	0722FL10	BIBI WALA	AMR	OK	31.03.2023		Category 5-UPS				13190488	900-450/577/1-1-1	4,894	NA	Director/D	
B.9869	West	BATHINDA	11KV	DS CITY DIVN. BATHINDA	DS S/D Tech-1 Bathinda	D-Fl04	GOBINDPURA	NON AMR	OK	31.03.2023		Category 1				13190488	900-450/577/1-1-1	8,122	NA	Director/D	
B.9870	West	BATHINDA	11KV	DS CITY DIVN. BATHINDA	DS S/D Tech-1 Bathinda	0789FL04	11 KV ZILA PARISHAD	NON AMR	OK	31.03.2023		Category 1				5608	400-200/5-5	1,709	NA	Director/D	
B.9871	West	BATHINDA	11KV	DS CITY DIVN. BATHINDA	DS S/D Tech-1 Bathinda	0789FL05	11KV KANHAIYA CHOWK	AMR	OK	31.03.2023		Category 1				5679	400-200/5-5	5,717	NA	Director/D	
B.9872	West	BATHINDA	11KV	DS CITY DIVN. BATHINDA	DS S/D Tech-1 Bathinda	0389FL06	MILK PLANT	AMR	OK	31.03.2023		Category 4				15194808	Not installed	4,203	NA	Director/D	
B.9873	West	BATHINDA	11KV	DS CITY DIVN. BATHINDA	DS S/D Tech-1 Bathinda	0389FL07	Industrial	AMR	OK	31.03.2023		Category 2				9568148	Not installed	5,863	NA	Director/D	
B.9874	West	BATHINDA	11KV	DS CITY DIVN. BATHINDA	DS S/D Tech-1 Bathinda	0389FL01	11 KV House Fed	AMR	OK	31.03.2023		Category 1				9568189	Not installed	5,997	NA	Director/D	
B.9875	West	BATHINDA	11KV	DS CITY DIVN. BATHINDA	DS S/D Tech-1 Bathinda	0375FL05	KARGIL	AMR	OK	31.03.2023		Category 1				0197975	Not installed	8,434	NA	Director/D	
B.9876	West	BATHINDA	11KV	DS CITY DIVN. BATHINDA	DS S/D Tech-1 Bathinda	0389FL12	BATHINDA CHEMICAL	NON AMR	OK	31.03.2023		Category 4				15196075	Not installed	9,387	NA	Director/D	
B.9877	West	BATHINDA	11KV	DS CITY DIVN. BATHINDA	DS S/D Tech-1 Bathinda	0389FL14	11 KV DEEP SINGH NAGAR	AMR	OK	31.03.2023		Category 1				2383	Not installed	9,425	NA	Director/D	
B.9878	West	BATHINDA	11KV	DS CITY DIVN. BATHINDA	DS S/D Tech-1 Bathinda	0375FL05	HR FORCE	AMR	OK	31.03.2023		Category 1				9568921	Not installed	5,642	NA	Director/D	
B.9879	West	BATHINDA	11KV	DS CITY DIVN. BATHINDA	DS S/D Tech-1 Bathinda	0375FL11	BIBI WALA	AMR	OK	31.03.2023		Category 5-UPS				9568089	Not installed	0,000	NA	Director/D	
B.9880	West	BATHINDA	11KV	DS CITY DIVN. BATHINDA	DS S/D Tech-1 Bathinda	0375FL02	M.E.S.(STANDBY) /WATER WORKS	AMR	OK	31.03.2023		Category 4				9568091	Not installed	0,306	NA	Director/D	
B.9881	West	BATHINDA	11KV	DS CITY DIVN. BATHINDA	DS S/D Tech-1 Bathinda	0375FL01	BIBI WALA	AMR	OK	31.03.2023		AP 3Phase 3Wire				9568229	Not installed	0,604	NA	Director/D	
B.9882	West	BATHINDA	11KV	DS CITY DIVN. BATHINDA	DS S/D Tech-1 Bathinda	0375FL14	Reliance Market	AMR	OK	31.03.2023		Category 1				8223514	Not installed	1,893	NA	Director/D	
B.9883	West	BATHINDA	11KV	DS CITY DIVN. BATHINDA	DS S/D Tech-1 Bathinda	0375FL26	Polychrome	AMR	OK	31.03.2023		Category 4				9568092	Not installed	2,546	NA	Director/D	
B.9884	West	BATHINDA	11KV	DS CITY DIVN. BATHINDA	DS S/D Tech-1 Bathinda	0375FL17	MODEL TOWN PHASE 4&5	AMR	OK	31.03.2023		Category 1				15193754	Not installed	2,586	NA	Director/D	
B.9885	West	BATHINDA	11KV	DS CITY DIVN. BATHINDA	DS S/D Tech-1 Bathinda	0375FL12	KAMLA NEHRU	NON AMR	OK	31.03.2023		Category 1				11117048	Not installed	3,212	NA	Director/D	
B.9886	West	BATHINDA	11KV	DS CITY DIVN. BATHINDA	DS S/D Tech-1 Bathinda	0375FL27	11 KV WATER WORKS	NON AMR	OK	31.03.2023		Category 4				9568089	Not installed	3,234	NA	Director/D	
B.9887	West	BATHINDA	11KV	DS CITY DIVN. BATHINDA	DS S/D Tech-1 Bathinda	0375FL13	Patel Nagar	AMR	OK	31.03.2023		Category 1				9568114	Not installed	4,374	NA	Director/D	
B.9888	West	BATHINDA	11KV	DS CITY DIVN. BATHINDA	DS S/D Tech-1 Bathinda	0375FL15	GREEN CITY	NON AMR	OK	31.03.2023		Category 1				15193755	Not installed	4,451	NA	Director/D	
B.9889	West	BATHINDA	11KV	DS CITY DIVN. BATHINDA	DS S/D Tech-1 Bathinda	0375FL18	STADIUM	AMR	OK	31.03.2023		Category 1				16199628	Not installed	4,819	NA	Director/D	
B.9890	West	BATHINDA	11KV	DS CITY DIVN. BATHINDA	DS S/D Tech-1 Bathinda	0375FL06	GANESHA BASTI	NON AMR	OK	31.03.2023		Category 1				9568176	Not installed	5,385	NA	Director/D	
B.9891	West	BATHINDA	11KV	DS CITY DIVN. BATHINDA	DS S/D Tech-1 Bathinda	0375FL09	TIN KONI	AMR	OK	31.03.2023		Category 1				9568276	Not installed	6,223	NA	Director/D	
B.9892	West	BATHINDA	11KV	DS CITY DIVN. BATHINDA	DS S/D Tech-1 Bathinda	0375FL03	FOUJI CHOWK	AMR	OK	31.03.2023		Category 1				9568227	Not installed	6,508	NA	Director/D	
B.9893	West	BATHINDA	11KV	DS CITY DIVN. BATHINDA	DS S/D Tech-1 Bathinda	0375FL04	DAYA NAND	NON AMR	OK	31.03.2023		Category 1				9568123	Not installed	6,511	NA	Director/D	
B.9894	West	BATHINDA	11KV	DS CITY DIVN. BATHINDA	DS S/D Tech-1 Bathinda	0375FL21	MUBA FARIO NAGAR	AMR	OK	31.03.2023		Category 1				8222467	Not installed	7,050	NA	Director/D	
B.9895	West	BATHINDA	11KV	DS CITY DIVN. BATHINDA	DS S/D Tech-1 Bathinda	0375FL22	BHATT ROAD	NON AMR	OK	31.03.2023		Category 1				9568225	Not installed	7,574	NA	Director/D	
B.9896	West	BATHINDA	11KV	DS CITY DIVN. BATHINDA	DS S/D Tech-1 Bathinda	0375FL19	NAMDDEV NAGAR	NON AMR	OK	31.03.2023		Category 1				16199622	Not installed	8,673	NA	Director/D	
B.9897	West	BATHINDA	11KV	DS CITY DIVN. BATHINDA	DS S/D Tech-1 Bathinda	0375FL20	BALLA RAM NAGAR	AMR	OK	31.03.2023		Category 1				16199238	Not installed	10,347	NA	Director/D	
B.9898	West	BATHINDA	11KV	DS CITY DIVN. BATHINDA	DS S/D Tech-1 Bathinda	0375FL07	SHIV COLONY	AMR	OK	31.03.2023		Category 1				9568216	Not installed	10,931	NA	Director/D	
B.9899	West	BATHINDA	11KV	DS CITY DIVN. BATHINDA	DS S/D Tech-1 Bathinda	0391FL06	JEewan PARKASH	NON AMR	OK	31.03.2023		Category 1				11114552	900-450/577/1-1-1	4,508	NA	Director/D	
B.9900	West	BATHINDA	11KV	DS CITY DIVN. BATHINDA	DS S/D Tech-1 Bathinda	0391FL05	MODEL TOWN PHASE -3	AMR	OK	31.03.2023		Category 1				9568175	900-450/5	5,725	NA	Director/D	
B.9901	West	BATHINDA	11KV	DS CITY DIVN. BATHINDA	DS S/D Tech-1 Bathinda	0391FL01	JUJHAR SINGH NAGAR	AMR	OK	31.03.2023		Category 1				9568226	900-450/577/1-1-1	6,231	NA	Director/D	
B.9902	West	BATHINDA	11KV	DS CITY DIVN. BATHINDA	DS S/D Tech-1 Bathinda	0391FL03	MODEL TOWN PHASE -1	AMR	OK	31.03.2023		Category 1				7336855	900-450/577/1-1-1	6,430	NA	Director/D	
B.9903	West	BATHINDA	11KV	DS CITY DIVN. BATHINDA	DS S/D Tech-1 Bathinda	0391FL02	GHORA CHOWNK	AMR	OK	31.03.2023		Category 1				11116924	900-450/5	6,666	NA	Director/D	
B.9904	West	BATHINDA	11KV	DS CITY DIVN. BATHINDA	DS S/D Tech-1 Bathinda	T909FL07	COMMUNITY CENTRE	AMR	OK	31.03.2023		Category 1				8222426	900-450/5	7,548	NA	Director/D	
B.9905	West	BATHINDA	11KV	DS CITY DIVN. BATHINDA	DS S/D Tech-1 Bathinda	0391FL04	MODEL TOWN PHASE -2	AMR	OK	31.03.2023		Category 1				9568224	900-450/577/1-1-1	9,060	NA	Director/D	
B.9906	West	BATHINDA	11KV	DS CITY DIVN. BATHINDA	DS S/D Tech-1 Bathinda	0409FL15	ARWA BASTI	Not available	OK	31.03.2023		Category 1				9153889	Not installed	9,418	NA	Director/D	
B.9907	West	BATHINDA	66KV	DS CITY DIVN. BATHINDA	DS S/D Tech-1 Bathinda	0376EL03	AIR FORCE	Not available	OK	31.03.2023		Category 4				Not available	Not available	6,358	NA	Director/D	
B.9908	West	BATHINDA	66KV	DS CITY DIVN. BATHINDA	DS S/D Tech-1 Bathinda	8352EL02	AMBUBIA CEMENT	Not available	OK	31.03.2023		Category 4				Not available	Not available	24,664	NA	Director/D	
B.9909	West	BATHINDA	132KV	DS CITY DIVN. BATHINDA	DS S/D Tech-1 Bathinda	8352EL02	N.F.L.	Not available	OK	31.03.2023		Category 4				Not available	Not available	47,459	NA	Director/D	
B.9910	West	BATHINDA	132KV	DS CITY DIVN. BATHINDA	DS S/D Tech-1 Bathinda	8352EL03	M.E.S.	AMR	OK	31.03.2023		Category 4				Not available	Not available	60,275	NA	Director/D	
B.9911	West	BATHINDA	11KV	DS CITY DIVN. BATHINDA	DS S/D Tech-2 Bathinda	0390FL07	PLUMB SPINTEX	NON AMR	OK	31.03.2023		Category 4				5349299	400-200/5-5	10,000	NA	Director/D	
B.9912	West	BATHINDA	11KV	DS CITY DIVN. BATHINDA	DS S/D Tech-2 Bathinda	8352FL10	PLANT -1	NON AMR	OK	31.03.2023		Category 1				1	Not installed	0,000	NA	Director/D	
B.9913	West	BATHINDA	11KV	DS CITY DIVN. BATHINDA	DS S/D Tech-2 Bathinda	8352FL11	PLANT - 2	NON AMR	OK	31.03.2023		Category 1				1	Not installed	0,001	NA	Director/D	
B.9914	West	BATHINDA	11KV	DS CITY DIVN. BATHINDA	DS S/D Tech-2 Bathinda	8352FL07	C-COMUND	NON AMR	OK	31.03.2023		Category 1				1	Not installed	0,474	NA	Director/D	
B.9915	West	BATHINDA	11KV	DS CITY DIVN. BATHINDA	DS S/D Tech-2 Bathinda	8352FL08	COLONY -1	NON AMR	OK	31.03.2023		Category 1				1	Not installed	0,610	NA	Director/D	
B.9916	West	BATHINDA	11KV	DS CITY DIVN. BATHINDA	DS S/D Tech-2 Bathinda	8352FL09	COLONY - 2	AMR	OK	31.03.2023		Category 1				1	Not installed	1,908	NA	Director/D	
B.9917	West	BATHINDA	11KV	DS CITY DIVN. BATHINDA	DS S/D Tech-2 Bathinda	0390FL09	THERMAL PLANT BACK FEEDING	AMR	OK	31.03.2023		Category 1				11117106	Not installed	9,005	NA	Director/D	
B.9918	West	BATHINDA	11KV	DS CITY DIVN. BATHINDA	DS S/D Tech-2 Bathinda	0390FL07	MITTAL MALL	AMR	OK	31.03.2023		Category 4				9154270	Not installed	4,054	NA	Director/D	
B.9919	West	BATHINDA	11KV	DS CITY DIVN. BATHINDA	DS S/D Tech-2 Bathinda	0390FL01	GOLE MARKET -1	AMR	OK	31.03.2023		Category 1				11114534	Not installed	4,224	NA	Director/D	
B.9920	West	BATHINDA	11KV	DS CITY DIVN. BATHINDA	DS S/D Tech-2 Bathinda	0390FL03	NORTHEN RAILWAY	NON AMR	OK	31.03.2023		Category 4				9568255	Not installed	4,239	NA	Director/D	
B.9921	West	BATHINDA	11KV	DS CITY DIVN. BATHINDA	DS S/D Tech-2 Bathinda	0399FL14	11 KV GOPAL NAGAR	AMR	OK	31.03.2023		Category 1				5976	Not installed	5,941	NA	Director/D	
B.9922	West	BATHINDA																			

S.No	Zone	Circle	Voltage Level (kVA)	Division (kVA)	Sub-Division (kVA)	Feeder ID	Feeder Name	Feeder Metering Status (Metered/unmetered/AMR/AM)	Status of Meter (Functional/Non-Functional)	Metering Date (Date of last actual meter reading/communication)	Feeder Type (Agr/Industrial/Mixed)	Status of Communication			Period from 01.04.2021 to 31.03.2022				Sales	Remarks (Source of data)
												% data received through automatically if feeder AMR/AM	Number of hours when meter was unable to communicate in overall	Total Number of hours in the period	Meter S.No	CT/PT ratio	Import (kWh)	Export (kWh)		
B.9961	West	BATHINDA	11KV	DS DIVN. BHAGTA BHAI	DS S/D BHAGTA BHAI KA	FL19D356	Gaidu Sahib	AMR	OK	31.03.2023	AP 3Phase 3Wire				23251	Not installed	1.996	NA	Director/D	
B.9962	West	BATHINDA	11KV	DS DIVN. BHAGTA BHAI	DS S/D BHAGTA BHAI KA	D356FL11	GURUSAR AP	AMR	OK	31.03.2023	AP 3Phase 3Wire				8223433	Not installed	2.051	NA	Director/D	
B.9963	West	BATHINDA	11KV	DS DIVN. BHAGTA BHAI	DS S/D BHAGTA BHAI KA	D356FL17	Gurmi New	NON AMR	OK	31.03.2023	AP 3Phase 3Wire				23209	Not installed	2.198	NA	Director/D	
B.9964	West	BATHINDA	11KV	DS DIVN. BHAGTA BHAI	DS S/D BHAGTA BHAI KA	D356FL16	11 KV Ramilla	AMR	OK	31.03.2023	AP 3Phase 3Wire				431119	Not installed	2.254	NA	Director/D	
B.9965	West	BATHINDA	11KV	DS DIVN. BHAGTA BHAI	DS S/D BHAGTA BHAI KA	D356FL00	GUMTI AP	AMR	OK	31.03.2023	AP 3Phase 3Wire				8222698	Not installed	2.423	NA	Director/D	
B.9966	West	BATHINDA	11KV	DS DIVN. BHAGTA BHAI	DS S/D BHAGTA BHAI KA	D356FL07	BURJ LADHA	AMR	OK	31.03.2023	AP 3Phase 3Wire				9141136	Not installed	2.581	NA	Director/D	
B.9967	West	BATHINDA	11KV	DS DIVN. BHAGTA BHAI	DS S/D BHAGTA BHAI KA	D356FL03	DYALPURA AP (BHAGTA)	AMR	OK	31.03.2023	AP 3Phase 3Wire				9141137	Not installed	2.586	NA	Director/D	
B.9968	West	BATHINDA	11KV	DS DIVN. BHAGTA BHAI	DS S/D BHAGTA BHAI KA	D356FL05	KEJAR SINGH WALA	NON AMR	OK	31.03.2023	AP 3Phase 3Wire				9141138	Not installed	2.946	NA	Director/D	
B.9969	West	BATHINDA	11KV	DS DIVN. BHAGTA BHAI	DS S/D BHAGTA BHAI KA	D356FL13	BURJ THAROD	NON AMR	OK	31.03.2023	AP 3Phase 3Wire				12093469	Not installed	2.997	NA	Director/D	
B.9970	West	BATHINDA	11KV	DS DIVN. BHAGTA BHAI	DS S/D BHAGTA BHAI KA	D356FL20	11 KV Industrial	NON AMR	OK	31.03.2023	Category 1				3296	Not installed	4.227	NA	Director/D	
B.9971	West	BATHINDA	11KV	DS DIVN. BHAGTA BHAI	DS S/D BHAGTA BHAI KA	D356FL14	Gaushala	AMR	OK	31.03.2023	Category 1				11117190	Not installed	4.808	NA	Director/D	
B.9972	West	BATHINDA	11KV	DS DIVN. BHAGTA BHAI	DS S/D BHAGTA BHAI KA	D356FL10	THARAJ (U) BAHGTA	AMR	OK	31.03.2023	Category 5-U/PS				6740721	Not installed	7.443	NA	Director/D	
B.9973	West	BATHINDA	11KV	DS DIVN. BHAGTA BHAI	DS S/D BHAGTA BHAI KA	D356FL02	BHAGTA (U)	NON AMR	OK	31.03.2023	Category 1				16266	Not installed	8.601	NA	Director/D	
B.9974	West	BATHINDA	11KV	DS DIVN. BHAGTA BHAI	DS S/D BHAGTA BHAI KA	D356FL18	11 KV Bhai Behlo	AMR	OK	31.03.2023	Category 1				23280	Not installed	12.711	NA	Director/D	
B.9975	West	BATHINDA	11KV	DS DIVN. BHAGTA BHAI	DS S/D BHAGTA BHAI KA	D356FL01	KOTHA GURU (UPS)	NON AMR	OK	31.03.2023	Category 5-U/PS				8388172	Not installed	17.382	NA	Director/D	
B.9976	West	BATHINDA	11KV	DS DIVN. BHAGTA BHAI	DS S/D BHAGTA BHAI KA	89FL02	Deraj Hirri wala	NON AMR	OK	31.03.2023	AP 3Phase 3Wire				12527320	900-450/5	2.311	NA	Director/D	
B.9977	West	BATHINDA	11KV	DS DIVN. BHAGTA BHAI	DS S/D BHAGTA BHAI KA	89FL06	Kaur Singh Wala	NON AMR	OK	31.03.2023	AP 3Phase 3Wire				73142935	900-450/5	2.318	NA	Director/D	
B.9978	West	BATHINDA	11KV	DS DIVN. BHAGTA BHAI	DS S/D BHAGTA BHAI KA	89FL01	GURUSAR(BHODIPURA)	NON AMR	OK	31.03.2023	AP 3Phase 3Wire				12527380	900-450/5	2.600	NA	Director/D	
B.9979	West	BATHINDA	11KV	DS DIVN. BHAGTA BHAI	DS S/D BHAGTA BHAI KA	X374FL08	11 KV Baba Vidhi Chand	NON AMR	OK	31.03.2023	AP 3Phase 3Wire				3418	900-450/5	2.728	NA	Director/D	
B.9980	West	BATHINDA	11KV	DS DIVN. BHAGTA BHAI	DS S/D BHAGTA BHAI KA	89FL05	Mann Singh Wala	NON AMR	OK	31.03.2023	AP 3Phase 3Wire				73144339	900-450/5	2.877	NA	Director/D	
B.9981	West	BATHINDA	11KV	DS DIVN. BHAGTA BHAI	DS S/D BHAGTA BHAI KA	D356FL04	KEJAR SINGH WALA(BHODIPURA)	NON AMR	OK	31.03.2023	AP 3Phase 3Wire				12527350	900-450/5	3.153	NA	Director/D	
B.9982	West	BATHINDA	11KV	DS DIVN. BHAGTA BHAI	DS S/D BHAGTA BHAI KA	89FL03	Bhodpura	NON AMR	OK	31.03.2023	Category 1				12527311	900-450/5	6.291	NA	Director/D	
B.9983	West	BATHINDA	11KV	DS DIVN. BHAGTA BHAI	DS S/D BHAGTA BHAI KA	BHODFL07	KAUR SINGH WALA	NON AMR	OK	31.03.2023	Category 5-U/PS				23460	900-450/5	6.916	NA	Director/D	
B.9984	West	BATHINDA	11KV	DS DIVN. BHAGTA BHAI	DS S/D BHAGTA BHAI KA	FL11X392	Dyalpura New	AMR	OK	31.03.2023	AP 3Phase 3Wire				2772	Not installed	1.383	NA	Director/D	
B.9985	West	BATHINDA	11KV	DS DIVN. BHAGTA BHAI	DS S/D BHAGTA BHAI KA	X392FL15	BABA BADAJLA	AMR	OK	31.03.2023	AP 3Phase 3Wire				11069736	Not installed	1.472	NA	Director/D	
B.9986	West	BATHINDA	11KV	DS DIVN. BHAGTA BHAI	DS S/D BHAGTA BHAI KA	X392FL13	DYALPURA MRZA AP	NON AMR	OK	31.03.2023	AP 3Phase 3Wire				11069749	Not installed	1.805	NA	Director/D	
B.9987	West	BATHINDA	11KV	DS DIVN. BHAGTA BHAI	DS S/D BHAGTA BHAI KA	X376FL12	11 KV BABA BADAJLA NEW	AMR	OK	31.03.2023	AP 3Phase 3Wire				3315	Not installed	1.832	NA	Director/D	
B.9988	West	BATHINDA	11KV	DS DIVN. BHAGTA BHAI	DS S/D BHAGTA BHAI KA	X392FL14	KOTHA GURU AP	NON AMR	OK	31.03.2023	AP 3Phase 3Wire				11117064	Not installed	1.980	NA	Director/D	
B.9989	West	BATHINDA	11KV	DS DIVN. BHAGTA BHAI	DS S/D BHAGTA BHAI KA	X392FL10	Gungsar Sahib	NON AMR	OK	31.03.2023	AP 3Phase 3Wire				37093	Not installed	2.148	NA	Director/D	
B.9990	West	BATHINDA	11KV	DS DIVN. BHAGTA BHAI	DS S/D BHAGTA BHAI KA	D392FL09	Mujan Wala	AMR	OK	31.03.2023	AP 3Phase 3Wire				37160	Not installed	2.408	NA	Director/D	
B.9991	West	BATHINDA	11KV	DS DIVN. BHAGTA BHAI	DS S/D BHAGTA BHAI KA	X392FL09	DYALPURA MRZA (U)	NON AMR	OK	31.03.2023	Category 1				11069735	Not installed	5.781	NA	Director/D	
B.9992	West	BATHINDA	11KV	DS DIVN. BHAGTA BHAI	DS S/D BHAGTA BHAI KA	D356FL10	Gungsar AP	AMR	OK	31.03.2023	AP 3Phase 3Wire				37080	Not installed	1.847	NA	Director/D	
B.9993	West	BATHINDA	11KV	DS DIVN. BHAGTA BHAI	DS S/D BHAGTA BHAI KA	D356FL01	JALAL AP	NON AMR	OK	31.03.2023	AP 3Phase 3Wire				9141084	Not installed	2.045	NA	Director/D	
B.9994	West	BATHINDA	11KV	DS DIVN. BHAGTA BHAI	DS S/D BHAGTA BHAI KA	D356FL09	New Aalia	NON AMR	OK	31.03.2023	AP 3Phase 3Wire				37074	Not installed	2.117	NA	Director/D	
B.9995	West	BATHINDA	11KV	DS DIVN. BHAGTA BHAI	DS S/D BHAGTA BHAI KA	D356FL13	Hamirgah	AMR	OK	31.03.2023	AP 3Phase 3Wire				15193855	Not installed	2.169	NA	Director/D	
B.9996	West	BATHINDA	11KV	DS DIVN. BHAGTA BHAI	DS S/D BHAGTA BHAI KA	D356FL08	AKAMSAR SAHIB	AMR	OK	31.03.2023	AP 3Phase 3Wire				10282854	Not installed	2.192	NA	Director/D	
B.9997	West	BATHINDA	11KV	DS DIVN. BHAGTA BHAI	DS S/D BHAGTA BHAI KA	D356FL03	DYALPURA JUKHANAN	AMR	OK	31.03.2023	AP 3Phase 3Wire				9141083	Not installed	2.446	NA	Director/D	
B.9998	West	BATHINDA	11KV	DS DIVN. BHAGTA BHAI	DS S/D BHAGTA BHAI KA	D356FL05	BHODPURA (JALAL)	AMR	OK	31.03.2023	AP 3Phase 3Wire				9141082	Not installed	2.447	NA	Director/D	
B.9999	West	BATHINDA	11KV	DS DIVN. BHAGTA BHAI	DS S/D BHAGTA BHAI KA	D356FL02	AALKIA	NON AMR	OK	31.03.2023	AP 3Phase 3Wire				9141085	Not installed	2.544	NA	Director/D	
B.10000	West	BATHINDA	11KV	DS DIVN. BHAGTA BHAI	DS S/D BHAGTA BHAI KA	D356FL07	Surlipura	AMR	OK	31.03.2023	AP 3Phase 3Wire				23277	Not installed	2.759	NA	Director/D	
B.10001	West	BATHINDA	11KV	DS DIVN. BHAGTA BHAI	DS S/D BHAGTA BHAI KA	FL11D358	11 KV Surlipura UPS	AMR	OK	31.03.2023	Category 5-U/PS				2798	Not installed	4.388	NA	Director/D	
B.10002	West	BATHINDA	11KV	DS DIVN. BHAGTA BHAI	DS S/D BHAGTA BHAI KA	D356FL06	GURUSAR (UPS)	AMR	OK	31.03.2023	Category 5-U/PS				6761932	Not installed	5.799	NA	Director/D	
B.10003	West	BATHINDA	11KV	DS DIVN. BHAGTA BHAI	DS S/D BHAGTA BHAI KA	D356FL04	JALAL AP	AMR	OK	31.03.2023	Category 1				6761929	Not installed	5.984	NA	Director/D	
B.10004	West	BATHINDA	11KV	DS DIVN. BHAGTA BHAI	DS S/D BHAGTA BHAI KA	MAULUF04	TARUANA SAHIB	NON AMR	OK	31.03.2023	Category 1				7042879	Not installed	0.127	NA	Director/D	
B.10005	West	BATHINDA	11KV	DS DIVN. BHAGTA BHAI	DS S/D BHAGTA BHAI KA	MAULUF08	11 KV Burj Tharor	NON AMR	OK	31.03.2023	AP 3Phase 3Wire				2781	Not installed	1.334	NA	Director/D	
B.10006	West	BATHINDA	11KV	DS DIVN. BHAGTA BHAI	DS S/D BHAGTA BHAI KA	MAULUF06	DERANAGEWALA	AMR	OK	31.03.2023	AP 3Phase 3Wire				23326	Not installed	2.417	NA	Director/D	
B.10007	West	BATHINDA	11KV	DS DIVN. BHAGTA BHAI	DS S/D BHAGTA BHAI KA	MAULUF02	NEOR	NON AMR	OK	31.03.2023	AP 3Phase 3Wire				8223435	Not installed	2.444	NA	Director/D	
B.10008	West	BATHINDA	11KV	DS DIVN. BHAGTA BHAI	DS S/D BHAGTA BHAI KA	MAULUF05	KTMALUPA	AMR	OK	31.03.2023	AP 3Phase 3Wire				23512	Not installed	2.756	NA	Director/D	
B.10009	West	BATHINDA	11KV	DS DIVN. BHAGTA BHAI	DS S/D BHAGTA BHAI KA	MAULUF03	MALLUJ AP (MALLUKA)	AMR	OK	31.03.2023	AP 3Phase 3Wire				8223434	Not installed	2.893	NA	Director/D	
B.10010	West	BATHINDA	11KV	DS DIVN. BHAGTA BHAI	DS S/D BHAGTA BHAI KA	MAULUF07	11 KV Neer UPS	NON AMR	OK	31.03.2023	Category 5-U/PS				16199309	Not installed	3.250	NA	Director/D	
B.10011	West	BATHINDA	11KV	DS DIVN. BHAGTA BHAI	DS S/D BHAGTA BHAI KA	MAULUF01	MALUKA (LUPS)	NON AMR	OK	31.03.2023	Category 1				6220	900-450/577/1-1-1	9.968	NA	Director/D	
B.10012	West	BATHINDA	11KV	DS DIVN. BHAGTA BHAI	DS S/D BHAGTA BHAI KA	S358FL14	11 KV Dera Bhorawala New	AMR	OK	31.03.2023	AP 3Phase 3Wire				2808	Not installed	1.591	NA	Director/D	
B.10013	West	BATHINDA	11KV	DS DIVN. BHAGTA BHAI	DS S/D BHAGTA BHAI KA	SUKHF05	BHOREWALA	NON AMR	OK	31.03.2023	AP 3Phase 3Wire				7346636	Not installed	1.594	NA	Director/D	
B.10014	West	BATHINDA	11KV	DS DIVN. BHAGTA BHAI	DS S/D BHAGTA BHAI KA	SUKHF08	Burj Ladhia AP	AMR	OK	31.03.2023	AP 3Phase 3Wire				15194054	900-450/577/1-1-1	1.765	NA	Director/D	
B.10015	West	BATHINDA	11KV	DS DIVN. BHAGTA BHAI	DS S/D BHAGTA BHAI KA	SUKHF14	11 KV Burj Ladhia NEW	AMR	OK	31.03.2023	AP 3Phase 3Wire				15194676	Not installed	1.885	NA	Director/D	
B.10016	West	BATHINDA	11KV	DS DIVN. BHAGTA BHAI	DS S/D BHAGTA BHAI KA	SUKHF00	SUKHANAND AP (SUKHANAND)	AMR	OK	31.03.2023	AP 3Phase 3Wire				7336702	Not installed	2.491	NA	Director/D	
B.10017	West	BATHINDA	11KV	DS DIVN. BHAGTA BHAI	DS S/D BHAGTA BHAI KA	SUKHF03	SANTUWALA	AMR	OK	31.03.2023	AP 3Phase 3Wire				7336719	Not installed	2.898	NA	Director/D	
B.10018	West	BATHINDA	11KV	DS DIVN. BHAGTA BHAI	DS S/D BHAGTA BHAI KA	SUKHF02	SUKHANAND (U)	AMR	OK	31.03.2023	Category 1				7336729	Not installed	7.162	NA	Director/D	
B.10019	West	BATHINDA	11KV	DS DIVN. BHAGTA BHAI	DS S/D BHAGTA BHAI KA	D356FL05	BHODPURA (THARAJ)	NON AMR	OK	31.03.2023	AP 3Phase 3Wire				10282773	Not installed	1.462	NA	Director/D	
B.10020	West	BATHINDA	11KV	DS DIVN. BHAGTA BHAI	DS S/D BHAGTA BHAI KA	D392FL10	11 KV Swami Parmanand	NON AMR	OK	31.03.2023	AP 3Phase 3Wire				15194699	Not installed	1.902	NA	Director/D	
B.10021	West	BATHINDA	11KV	DS DIVN. BHAGTA BHAI	DS S/D BHAGTA BHAI KA	THFL02	DHILMA	AMR	OK	31.03.2023	AP 3Phase 3Wire				7042837	Not installed	2.010	NA	Director/D	
B.10022	West	BATHINDA	11KV	DS DIVN. BHAGTA BHAI	DS S/D BHAGTA BHAI KA	THARFL08	DALU WALA (UPS)	AMR	OK	31.03.2023	Category 5-U/PS				12093590	Not installed	2.250	NA	Director/D	
B.10023	West	BATHINDA	11KV	DS DIVN. BHAGTA BHAI	DS S/D BHAGTA BHAI KA	THFL06	DHUNDRA	AMR	OK	31.03.2023	AP 3Phase 3Wire				9454088	Not installed	2.263	NA	Director/D	
B.10024	West	BATHINDA	11KV	DS DIVN. BHAGTA BHAI	DS S/D BHAGTA BHAI KA	THFL01	THARAJ AP	AMR	OK	31.03.2023	AP 3Phase 3Wire				7042902	Not installed	2.460	NA	Director/D	
B.10025	West	BATHINDA	11KV	DS DIVN. BHAGTA BHAI	DS S/D BHAGTA BHAI KA	THFL04	THARAJ (UPS)	NON AMR	OK	31.03.2023	Category 1				7042863	Not installed	2.790	NA	Director/D	
B.10026	West	BATHINDA	11KV	DS DIVN. BHAGTA BHAI	DS S/D BHAGTA BHAI KA	THFL07	DALUWALA	AMR	OK	31.03.2023	AP 3Phase 3Wire				23744	Not installed	2.831	NA	Director/D	
B.10027	West	BATHINDA	11KV	DS DIVN. BHAGTA BHAI																

S.No	Zone	Circle	Voltage Level (kVA)	Division (kVA)	Sub-Division (kVA)	Feeder ID	Feeder Name	Feeder Metering Status (Metered/unmetered/AMR/AMI)	Status of Meter (Functional/Non-functional)	Metering Date	Date of last actual meter reading/communication	Feeder Type (Agr/Industrial/Mixed)	Status of Communication			Period from 01.04.2021 to 31.03.2022				Sales	Remarks (Source of data)
													% data received through automatically if feeder AMR/AMI	Number of hours when meter was unable to communicate in overall	Total Number of hours in the period	Meter S.No	CT/PT ratio	Import (kWh)	Export (kWh)		
B.10058	West	BATHINDA	11KV	DS DIVN. BHAGTA BHA	DS S/D BHAI RUPA	DYALF03	SALABATPURA (AP)	NON AMR	OK	31.03.2023		AP 3Phase 3Wire	9534524	Not installed	1,462	NA	Director/D				
B.10059	West	BATHINDA	11KV	DS DIVN. BHAGTA BHA	DS S/D BHAI RUPA	X359F14	11 KV BABA FARID AP	NON AMR	OK	31.03.2023		AP 3Phase 3Wire	1234	Not installed	1,718	NA	Director/D				
B.10060	West	BATHINDA	11KV	DS DIVN. BHAGTA BHA	DS S/D BHAI RUPA	DYALFL08	KOTHE GILLA WALA	NON AMR	OK	31.03.2023		AP 3Phase 3Wire	42233	Not installed	1,877	NA	Director/D				
B.10061	West	BATHINDA	11KV	DS DIVN. BHAGTA BHA	DS S/D BHAI RUPA	DYALFL11	CHANDWALA	NON AMR	OK	31.03.2023		AP 3Phase 3Wire	1519476	Not installed	1,968	NA	Director/D				
B.10062	West	BATHINDA	11KV	DS DIVN. BHAGTA BHA	DS S/D BHAI RUPA	DYALFL10	Bhai Mani Singh	AMR	OK	31.03.2023		AP 3Phase 3Wire	1519484	Not installed	1,975	NA	Director/D				
B.10063	West	BATHINDA	11KV	DS DIVN. BHAGTA BHA	DS S/D BHAI RUPA	DYALFL12	DYALPURA AP (DYAL P BHA/KA)	NON AMR	OK	31.03.2023		AP 3Phase 3Wire	9534498	Not installed	2,115	NA	Director/D				
B.10064	West	BATHINDA	11KV	DS DIVN. BHAGTA BHA	DS S/D BHAI RUPA	FL13DYAL	11 KV Mai Rai	AMR	OK	31.03.2023		AP 3Phase 3Wire	73183212	Not installed	2,152	NA	Director/D				
B.10065	West	BATHINDA	11KV	DS DIVN. BHAGTA BHA	DS S/D BHAI RUPA	DYALFL04	JAFARNAMA SAHIB	NON AMR	OK	31.03.2023		AP 3Phase 3Wire	9534528	Not installed	2,530	NA	Director/D				
B.10066	West	BATHINDA	11KV	DS DIVN. BHAGTA BHA	DS S/D BHAI RUPA	DYALFL09	DULLEWALA AP	NON AMR	OK	31.03.2023		AP 3Phase 3Wire	15194654	Not installed	2,591	NA	Director/D				
B.10067	West	BATHINDA	11KV	DS DIVN. BHAGTA BHA	DS S/D BHAI RUPA	X359FL07	BURI RAGGAR AP	NON AMR	OK	31.03.2023		AP 3Phase 3Wire	43230	Not installed	2,689	NA	Director/D				
B.10068	West	BATHINDA	11KV	DS DIVN. BHAGTA BHA	DS S/D BHAI RUPA	X359FL05	11 KV ADAMPURA AP	AMR	OK	31.03.2023		AP 3Phase 3Wire	12093472	Not installed	2,748	NA	Director/D				
B.10069	West	BATHINDA	11KV	DS DIVN. BHAGTA BHA	DS S/D BHAI RUPA	FL12DYAL	Mehar Miha	AMR	OK	31.03.2023		AP 3Phase 3Wire	15194867	Not installed	3,031	NA	Director/D				
B.10070	West	BATHINDA	11KV	DS DIVN. BHAGTA BHA	DS S/D BHAI RUPA	X359FL06	11 KV DYALPURA UPS	AMR	OK	31.03.2023		Category 5-UPS	9534597	Not installed	4,705	NA	Director/D				
B.10071	West	BATHINDA	11KV	DS DIVN. BHAGTA BHA	DS S/D BHAI RUPA	X359FL01	SALABATPURA UPS	NON AMR	OK	31.03.2023		Category 5-UPS	9534401	Not installed	6,221	NA	Director/D				
B.10072	West	BATHINDA	11KV	DS DIVN. BHAGTA BHA	DS S/D BHAI RUPA	X392FL07	Gumti Jand Sahib AP(Dyalgra M)	AMR	OK	31.03.2023		AP 3Phase 3Wire	23706	Not installed	2,395	NA	Director/D				
B.10073	West	BATHINDA	11KV	DS DIVN. BHAGTA BHA	DS S/D BHAI RUPA	X392FL16	MANNI WALA AP	AMR	OK	31.03.2023		AP 3Phase 3Wire	11069747	Not installed	3,214	NA	Director/D				
B.10074	West	BATHINDA	11KV	DS DIVN. BHAGTA BHA	DS S/D BHAI RUPA	X392FL08	SAMADHI WALA	AMR	OK	31.03.2023		AP 3Phase 3Wire	11069733	Not installed	3,544	NA	Director/D				
B.10075	West	BATHINDA	11KV	DS DIVN. BHAGTA BHA	DS S/D BHAI RUPA	X392FL10	GUMTI UPS	AMR	OK	31.03.2023		Category 5-UPS	1117007	Not installed	9,119	NA	Director/D				
B.10076	West	BATHINDA	11KV	DS DIVN. BHAGTA BHA	DS S/D BHAI RUPA	D358FL12	Jani Sahib	AMR	OK	31.03.2023		AP 3Phase 3Wire	9141081	Not installed	2,204	NA	Director/D				
B.10077	West	BATHINDA	11KV	DS DIVN. BHAGTA BHA	DS S/D BHAI RUPA	D358FL04	SIDHANA	NON AMR	OK	31.03.2023		AP 3Phase 3Wire	9565137	Not installed	2,468	NA	Director/D				
B.10078	West	BATHINDA	11KV	DS DIVN. BHAGTA BHA	DS S/D BHAI RUPA	selbFL03	Kaloke (selbrah)	NON AMR	OK	31.03.2023		Category 1	15196117	400-200/5-5	1,280	NA	Director/D				
B.10079	West	BATHINDA	11KV	DS DIVN. BHAGTA BHA	DS S/D BHAI RUPA	FL07selb	11 KV Baba Deep Singh	NON AMR	OK	31.03.2023		AP 3Phase 3Wire	2740	400-200/5-5	2,342	NA	Director/D				
B.10080	West	BATHINDA	11KV	DS DIVN. BHAGTA BHA	DS S/D BHAI RUPA	selbFL02	Baba Sidh	NON AMR	OK	31.03.2023		AP 3Phase 3Wire	16194307	400-200/5-5	2,354	NA	Director/D				
B.10081	West	BATHINDA	11KV	DS DIVN. BHAGTA BHA	DS S/D BHAI RUPA	X37FL06	Dhab Wala	NON AMR	OK	31.03.2023		AP 3Phase 3Wire	2656	400-200/5-5	2,510	NA	Director/D				
B.10082	West	BATHINDA	11KV	DS DIVN. BHAGTA BHA	DS S/D BHAI RUPA	selbFL04	Thrth	NON AMR	OK	31.03.2023		AP 3Phase 3Wire	1441	400-200/5-5	2,747	NA	Director/D				
B.10083	West	BATHINDA	11KV	DS DIVN. BHAGTA BHA	DS S/D BHAI RUPA	selbFL01	SERBAN URBAN	NON AMR	OK	31.03.2023		Category 1	16194340	400-200/5-5	12,401	NA	Director/D				
B.10084	West	BATHINDA	11KV	DS DIVN. BHAGTA BHA	DS S/D NATHANA	DGANFL01	GANGA URBAN	NON AMR	OK	31.03.2023		Category 1	16194473	400-200/5-5	2,020	NA	Director/D				
B.10085	West	BATHINDA	11KV	DS DIVN. BHAGTA BHA	DS S/D NATHANA	DGANFL03	UDHARSAR AP	NON AMR	OK	31.03.2023		AP 3Phase 3Wire	16194403	400-200/5-5	2,597	NA	Director/D				
B.10086	West	BATHINDA	11KV	DS DIVN. BHAGTA BHA	DS S/D NATHANA	FL06GANF	11 KV Baba Mohan Dass	NON AMR	OK	31.03.2023		AP 3Phase 3Wire	2761	400-200/5-5	2,905	NA	Director/D				
B.10087	West	BATHINDA	11KV	DS DIVN. BHAGTA BHA	DS S/D NATHANA	DGANFL05	Dera Data Hari Singh	NON AMR	OK	31.03.2023		AP 3Phase 3Wire	2745	400-200/5-5	3,300	NA	Director/D				
B.10088	West	BATHINDA	11KV	DS DIVN. BHAGTA BHA	DS S/D NATHANA	X382FL07	11 KV New Jandawala	NON AMR	OK	31.03.2023		Category 5-UPS	9658	400-200/5-5	4,577	NA	Director/D				
B.10089	West	BATHINDA	11KV	DS DIVN. BHAGTA BHA	DS S/D NATHANA	DGANFL02	BIDOLI UPS	NON AMR	OK	31.03.2023		Category 5-UPS	16198465	400-200/5-5	4,890	NA	Director/D				
B.10090	West	BATHINDA	11KV	DS DIVN. BHAGTA BHA	DS S/D NATHANA	D418FL11	11 KV Kotha Kheta Singh Wala	AMR	OK	31.03.2023		AP 3Phase 3Wire	15194775	900-450/577/1-1-1	1,661	NA	Director/D				
B.10091	West	BATHINDA	11KV	DS DIVN. BHAGTA BHA	DS S/D NATHANA	D418FL01	KHEMJANA	NON AMR	OK	31.03.2023		AP 3Phase 3Wire	1.1111E+13	1200/577/1-1-1	2,257	NA	Director/D				
B.10092	West	BATHINDA	11KV	DS DIVN. BHAGTA BHA	DS S/D NATHANA	D418FL12	11 KV SHER WALA RURAL	AMR	OK	31.03.2023		AP 3Phase 3Wire	15193816	900-450/577/1-1-1	2,415	NA	Director/D				
B.10093	West	BATHINDA	11KV	DS DIVN. BHAGTA BHA	DS S/D NATHANA	D418FL06	JANDAWALA	AMR	OK	31.03.2023		AP 3Phase 3Wire	954721	900-450/577/1-1-1	2,912	NA	Director/D				
B.10094	West	BATHINDA	11KV	DS DIVN. BHAGTA BHA	DS S/D NATHANA	D418FL08	Jandawala	NON AMR	OK	31.03.2023		Category 5-UPS	32502	900-450/577/1-1-1	3,901	NA	Director/D				
B.10095	West	BATHINDA	11KV	DS DIVN. BHAGTA BHA	DS S/D NATHANA	D384FL17	11 KV Romana	AMR	OK	31.03.2023		AP 3Phase 3Wire	37167	400-200/5-5	1,568	NA	Director/D				
B.10096	West	BATHINDA	11KV	DS DIVN. BHAGTA BHA	DS S/D NATHANA	D384FL14	Buri Dalia	NON AMR	OK	31.03.2023		AP 3Phase 3Wire	15194702	Not installed	1,575	NA	Director/D				
B.10097	West	BATHINDA	11KV	DS DIVN. BHAGTA BHA	DS S/D NATHANA	D384FL16	CHAPARI WALA	AMR	OK	31.03.2023		AP 3Phase 3Wire	5463622	Not installed	1,694	NA	Director/D				
B.10098	West	BATHINDA	11KV	DS DIVN. BHAGTA BHA	DS S/D NATHANA	D384FL03	GORING NAGAR	AMR	OK	31.03.2023		AP 3Phase 3Wire	8222607	Not installed	1,930	NA	Director/D				
B.10099	West	BATHINDA	11KV	DS DIVN. BHAGTA BHA	DS S/D NATHANA	D384FL12	BANI ANA AP	AMR	OK	31.03.2023		AP 3Phase 3Wire	37167	Not installed	2,272	NA	Director/D				
B.10100	West	BATHINDA	11KV	DS DIVN. BHAGTA BHA	DS S/D NATHANA	D384FL05	BABA GAT	NON AMR	OK	31.03.2023		AP 3Phase 3Wire	8222606	Not installed	2,420	NA	Director/D				
B.10101	West	BATHINDA	11KV	DS DIVN. BHAGTA BHA	DS S/D NATHANA	D384FL13	kalyan sarda AP	NON AMR	OK	31.03.2023		AP 3Phase 3Wire	37225	400-200/5-5	2,583	NA	Director/D				
B.10102	West	BATHINDA	11KV	DS DIVN. BHAGTA BHA	DS S/D NATHANA	D384FL10	Baba Kalyan Dass	NON AMR	OK	31.03.2023		AP 3Phase 3Wire	12527376	Not installed	2,714	NA	Director/D				
B.10103	West	BATHINDA	11KV	DS DIVN. BHAGTA BHA	DS S/D NATHANA	D384FL09	mari	AMR	OK	31.03.2023		AP 3Phase 3Wire	12527372	Not installed	2,719	NA	Director/D				
B.10104	West	BATHINDA	11KV	DS DIVN. BHAGTA BHA	DS S/D NATHANA	D384FL08	GALSHALA	AMR	OK	31.03.2023		AP 3Phase 3Wire	9542413	Not installed	2,729	NA	Director/D				
B.10105	West	BATHINDA	11KV	DS DIVN. BHAGTA BHA	DS S/D NATHANA	D384FL04	BHAINI	AMR	OK	31.03.2023		AP 3Phase 3Wire	12524262	Not installed	2,816	NA	Director/D				
B.10106	West	BATHINDA	11KV	DS DIVN. BHAGTA BHA	DS S/D NATHANA	D384FL11	Nathpura	AMR	OK	31.03.2023		AP 3Phase 3Wire	12527374	400-200/5-5	2,976	NA	Director/D				
B.10107	West	BATHINDA	11KV	DS DIVN. BHAGTA BHA	DS S/D NATHANA	D384FL02	KALYAN MALIKA	AMR	OK	31.03.2023		AP 3Phase 3Wire	8222608	Not installed	3,017	NA	Director/D				
B.10108	West	BATHINDA	11KV	DS DIVN. BHAGTA BHA	DS S/D NATHANA	D384FL15	Doon	AMR	OK	31.03.2023		AP 3Phase 3Wire	8222609	Not installed	3,153	NA	Director/D				
B.10109	West	BATHINDA	11KV	DS DIVN. BHAGTA BHA	DS S/D NATHANA	D384FL07	KALYAN	AMR	OK	31.03.2023		AP 3Phase 3Wire	8222609	400-200/5-5	3,401	NA	Director/D				
B.10110	West	BATHINDA	11KV	DS DIVN. BHAGTA BHA	DS S/D NATHANA	D384FL01	KALYAN SUKHA	AMR	OK	31.03.2023		Category 1	9154199	Not installed	7,421	NA	Director/D				
B.10111	West	BATHINDA	11KV	DS DIVN. BHAGTA BHA	DS S/D NATHANA	D384FL06	BHAINI	NON AMR	OK	31.03.2023		Category 5-UPS	5463622	400-200/5-5	8,064	NA	Director/D				
B.10112	West	BATHINDA	11KV	DS DIVN. BHAGTA BHA	DS S/D NATHANA	MehrFL08	Gumatar	AMR	OK	31.03.2023		AP 3Phase 3Wire	12527365	900-450/577/1-1-1	2,246	NA	Director/D				
B.10113	West	BATHINDA	11KV	DS DIVN. BHAGTA BHA	DS S/D NATHANA	T901FL11	MALLIANA AP	NON AMR	OK	31.03.2023		AP 3Phase 3Wire	10273736	900-450/577/1-1-1	2,292	NA	Director/D				
B.10114	West	BATHINDA	11KV	DS DIVN. BHAGTA BHA	DS S/D NATHANA	MehrFL09	Babamool	NON AMR	OK	31.03.2023		AP 3Phase 3Wire	10273728	900-450/577/1-1-1	2,887	NA	Director/D				
B.10115	West	BATHINDA	11KV	DS DIVN. BHAGTA BHA	DS S/D NATHANA	MehrFL07	Kothe Rathiran	NON AMR	OK	31.03.2023		AP 3Phase 3Wire	10273741	400-200/5-5	3,557	NA	Director/D				
B.10116	West	BATHINDA	11KV	DS DIVN. BHAGTA BHA	DS S/D NATHANA	D357FL05	Jal Singh	NON AMR	OK	31.03.2023		AP 3Phase 3Wire	1.14E+07	900-450/577/1-1-1	9,767	NA	Director/D				
B.10117	West	BATHINDA	11KV	DS DIVN. BHAGTA BHA	DS S/D NATHANA	D357FL08	Jandawala Road	NON AMR	OK	31.03.2023		AP 3Phase 3Wire	8222610	Not installed	1,878	NA	Director/D				

S.No	Zone	Circle	Voltage Level (kVA)	Division (kVA)	Sub-Division (kVA)	Feeder ID	Feeder Name	Feeder Metering Status (Metered/unmetered/AMR/AMI)	Status of Meter (Functional/Non-Functional)	Metering Date (Date of last actual meter reading/communication)	Feeder Type (Agr/Industrial/Mixed)	Status of Communication			Period from 01.04.2021 to 31.03.2022				Sales	Remarks (Source of data)
												% data received through automatically if feeder AMR/AMI	Number of hours when meter was unable to communicate in overall	Total Number of hours in the period	Meter S.No	CT/PT ratio	Import (kU)	Export (kU)		
B.10155	West	BATHINDA	11KV	DS DIVN. BUDHLADA	DS S/D BARETA	D388FL02	Chakalsher AP	AMR	OK	31.03.2023	AP 3Phase 3Wire				8222941	Not installed	1.742	NA	Director/D	
B.10156	West	BATHINDA	11KV	DS DIVN. BUDHLADA	DS S/D BARETA	D388FL03	BHAWA AP	AMR	OK	31.03.2023	AP 3Phase 3Wire				9141163	Not installed	1.756	NA	Director/D	
B.10157	West	BATHINDA	11KV	DS DIVN. BUDHLADA	DS S/D BARETA	D388FL07	Dashmesh Nagar	NON AMR	OK	31.03.2023	AP 3Phase 3Wire				11052080	Not installed	1.997	NA	Director/D	
B.10158	West	BATHINDA	11KV	DS DIVN. BUDHLADA	DS S/D BARETA	D388FL08	Todapur AP	NON AMR	OK	31.03.2023	AP 3Phase 3Wire				231700	Not installed	2.084	NA	Director/D	
B.10159	West	BATHINDA	11KV	DS DIVN. BUDHLADA	DS S/D BARETA	D388FL10	Birewala AP	AMR	OK	31.03.2023	AP 3Phase 3Wire				34206	Not installed	2.126	NA	Director/D	
B.10160	West	BATHINDA	11KV	DS DIVN. BUDHLADA	DS S/D BARETA	D388FL01	CHAKALI SHER UPS	AMR	OK	31.03.2023	Category 5-UPS				6669350	Not installed	8.479	NA	Director/D	
B.10161	West	BATHINDA	11KV	DS DIVN. BUDHLADA	DS S/D BARETA	D388FL17	DHALIWAL AP FEEDER	AMR	OK	31.03.2023	AP 3Phase 3Wire				4453	Not installed	0.002	NA	Director/D	
B.10162	West	BATHINDA	11KV	DS DIVN. BUDHLADA	DS S/D BARETA	D388FL14	11 KV BABA DHYAN DAS	AMR	OK	31.03.2023	AP 3Phase 3Wire				3894	Not installed	1.410	NA	Director/D	
B.10163	West	BATHINDA	11KV	DS DIVN. BUDHLADA	DS S/D BARETA	D388FL06	Soni Wala AP	AMR	OK	31.03.2023	AP 3Phase 3Wire				11052089	Not installed	1.466	NA	Director/D	
B.10164	West	BATHINDA	11KV	DS DIVN. BUDHLADA	DS S/D BARETA	D388FL15	11 KV CHALHAN AP	NON AMR	OK	31.03.2023	AP 3Phase 3Wire				3930	Not installed	2.416	NA	Director/D	
B.10165	West	BATHINDA	11KV	DS DIVN. BUDHLADA	DS S/D BARETA	D388FL08	Khatri Wala AP	AMR	OK	31.03.2023	AP 3Phase 3Wire				34233	Not installed	2.931	NA	Director/D	
B.10166	West	BATHINDA	11KV	DS DIVN. BUDHLADA	DS S/D BARETA	D388FL01	Rangrial AP	AMR	OK	31.03.2023	AP 3Phase 3Wire				9534487	Not installed	2.974	NA	Director/D	
B.10167	West	BATHINDA	11KV	DS DIVN. BUDHLADA	DS S/D BARETA	D369FL02	SEKHON PATI	AMR	OK	31.03.2023	AP 3Phase 3Wire				36791	Not installed	2.035	NA	Director/D	
B.10168	West	BATHINDA	11KV	DS DIVN. BUDHLADA	DS S/D BARETA	D369FL07	Chahal Patli	AMR	OK	31.03.2023	AP 3Phase 3Wire				1424	Not installed	2.208	NA	Director/D	
B.10169	West	BATHINDA	11KV	DS DIVN. BUDHLADA	DS S/D BARETA	D369FL05	DHILLON PATI	AMR	OK	31.03.2023	AP 3Phase 3Wire				34209	Not installed	2.471	NA	Director/D	
B.10170	West	BATHINDA	11KV	DS DIVN. BUDHLADA	DS S/D BARETA	D369FL03	DHALIWAL PATI	AMR	OK	31.03.2023	AP 3Phase 3Wire				36944	Not installed	2.603	NA	Director/D	
B.10171	West	BATHINDA	11KV	DS DIVN. BUDHLADA	DS S/D BARETA	D369FL06	KHUDAL	AMR	OK	31.03.2023	Category 5-UPS				36974	Not installed	6.944	NA	Director/D	
B.10172	West	BATHINDA	11KV	DS DIVN. BUDHLADA	DS S/D BARETA	D369FL04	KISHANGARH URBAN	NON AMR	OK	31.03.2023	Category 1				36676	Not installed	7.101	NA	Director/D	
B.10173	West	BATHINDA	11KV	DS DIVN. BUDHLADA	DS S/D BARETA	X352FL03	RANJIT SINGH WALA AP	NON AMR	OK	31.03.2023	AP 3Phase 3Wire				10283021	Not installed	1.595	NA	Director/D	
B.10174	West	BATHINDA	11KV	DS DIVN. BUDHLADA	DS S/D BARETA	X352FL16	11 KV Theri Wala	AMR	OK	31.03.2023	AP 3Phase 3Wire				15194668	Not installed	1.661	NA	Director/D	
B.10175	West	BATHINDA	11KV	DS DIVN. BUDHLADA	DS S/D BARETA	X352FL02	PANJ PEER AP	AMR	OK	31.03.2023	AP 3Phase 3Wire				10283777	Not installed	1.843	NA	Director/D	
B.10176	West	BATHINDA	11KV	DS DIVN. BUDHLADA	DS S/D BARETA	X352FL15	11 KV Sattan Wala AP	NON AMR	OK	31.03.2023	AP 3Phase 3Wire				15193824	Not installed	1.887	NA	Director/D	
B.10177	West	BATHINDA	11KV	DS DIVN. BUDHLADA	DS S/D BARETA	X352FL10	Sangheri AP	NON AMR	OK	31.03.2023	AP 3Phase 3Wire				15194697	Not installed	2.206	NA	Director/D	
B.10178	West	BATHINDA	11KV	DS DIVN. BUDHLADA	DS S/D BARETA	X352FL02	Deputy Wala AP	AMR	OK	31.03.2023	AP 3Phase 3Wire				10288310	Not installed	2.275	NA	Director/D	
B.10179	West	BATHINDA	11KV	DS DIVN. BUDHLADA	DS S/D BARETA	X352FL14	11 KV Kapoor Singh Wala	AMR	OK	31.03.2023	AP 3Phase 3Wire				15193923	Not installed	2.285	NA	Director/D	
B.10180	West	BATHINDA	11KV	DS DIVN. BUDHLADA	DS S/D BARETA	X352FL08	11 KV Nari Academy AP	AMR	OK	31.03.2023	AP 3Phase 3Wire				10283894	Not installed	2.318	NA	Director/D	
B.10181	West	BATHINDA	11KV	DS DIVN. BUDHLADA	DS S/D BARETA	X352FL06	Dhampurua AP	AMR	OK	31.03.2023	AP 3Phase 3Wire				11069764	Not installed	2.396	NA	Director/D	
B.10182	West	BATHINDA	11KV	DS DIVN. BUDHLADA	DS S/D BARETA	X352FL13	11 KV Sasgali AP	AMR	OK	31.03.2023	AP 3Phase 3Wire				15193803	Not installed	2.421	NA	Director/D	
B.10183	West	BATHINDA	11KV	DS DIVN. BUDHLADA	DS S/D BARETA	X352FL09	Chan Pura Dhani AP	AMR	OK	31.03.2023	AP 3Phase 3Wire				43161	Not installed	2.427	NA	Director/D	
B.10184	West	BATHINDA	11KV	DS DIVN. BUDHLADA	DS S/D BARETA	X352FL07	GORKHATHI AP	AMR	OK	31.03.2023	AP 3Phase 3Wire				11069753	Not installed	2.429	NA	Director/D	
B.10185	West	BATHINDA	11KV	DS DIVN. BUDHLADA	DS S/D BARETA	X352FL11	Bhakha Par AP	AMR	OK	31.03.2023	AP 3Phase 3Wire				43198	Not installed	2.661	NA	Director/D	
B.10186	West	BATHINDA	11KV	DS DIVN. BUDHLADA	DS S/D BARETA	X352FL18	Bohali Urban AP	AMR	OK	31.03.2023	AP 3Phase 3Wire				21056	Not installed	2.785	NA	Director/D	
B.10187	West	BATHINDA	11KV	DS DIVN. BUDHLADA	DS S/D BARETA	X352FL01	MANDER UPS	NON AMR	OK	31.03.2023	Category 5-UPS				10282859	Not installed	3.116	NA	Director/D	
B.10188	West	BATHINDA	11KV	DS DIVN. BUDHLADA	DS S/D BARETA	X352FL12	11 KV Kulian Urban	AMR	OK	31.03.2023	Category 1				10288394	Not installed	6.831	NA	Director/D	
B.10189	West	BATHINDA	11KV	DS DIVN. BUDHLADA	DS S/D BARETA	X209FL09	KALIA	NON AMR	OK	31.03.2023	AP 3Phase 3Wire				7336720	900-450/5	1.500	NA	Director/D	
B.10190	West	BATHINDA	11KV	DS DIVN. BUDHLADA	DS S/D BARETA	X209FL11	11 KV Khudal AP	AMR	OK	31.03.2023	AP 3Phase 3Wire				43157	900-450/577/1-1-1	1.582	NA	Director/D	
B.10191	West	BATHINDA	11KV	DS DIVN. BUDHLADA	DS S/D BARETA	X209FL13	11 KV BABA BETA SHAM AP	AMR	OK	31.03.2023	AP 3Phase 3Wire				2353085	900-450/577/1-1-1	1.861	NA	Director/D	
B.10192	West	BATHINDA	11KV	DS DIVN. BUDHLADA	DS S/D BARETA	X209FL08	Gurdyn Bahokwala	NON AMR	OK	31.03.2023	AP 3Phase 3Wire				9154439	900-450/5	2.204	NA	Director/D	
B.10193	West	BATHINDA	11KV	DS DIVN. BUDHLADA	DS S/D BHIKHI	D399FL08	11 KV Billana	AMR	OK	31.03.2023	AP 3Phase 3Wire				23611	Not installed	2.402	NA	Director/D	
B.10194	West	BATHINDA	11KV	DS DIVN. BUDHLADA	DS S/D BHIKHI	D370FL16	11 KV Waste Plant	AMR	OK	31.03.2023	Category 4				6117	Not installed	0.140	NA	Director/D	
B.10195	West	BATHINDA	11KV	DS DIVN. BUDHLADA	DS S/D BHIKHI	D370FL10	MULLA SINGH WALA	AMR	OK	31.03.2023	AP 3Phase 3Wire				4221010	Not installed	1.480	NA	Director/D	
B.10196	West	BATHINDA	11KV	DS DIVN. BUDHLADA	DS S/D BHIKHI	D370FL03	Kotra	AMR	OK	31.03.2023	AP 3Phase 3Wire				8223773	Not installed	1.606	NA	Director/D	
B.10197	West	BATHINDA	11KV	DS DIVN. BUDHLADA	DS S/D BHIKHI	D370FL17	11 KV Lopiana AP	AMR	OK	31.03.2023	Category 1				11117083	Not installed	2.152	NA	Director/D	
B.10198	West	BATHINDA	11KV	DS DIVN. BUDHLADA	DS S/D BHIKHI	D370FL14	Dalel Singh Wala AP	AMR	OK	31.03.2023	AP 3Phase 3Wire				199048	Not installed	2.196	NA	Director/D	
B.10199	West	BATHINDA	11KV	DS DIVN. BUDHLADA	DS S/D BHIKHI	D370FL06	Pharwahi	AMR	OK	31.03.2023	AP 3Phase 3Wire				11116959	Not installed	2.276	NA	Director/D	
B.10200	West	BATHINDA	11KV	DS DIVN. BUDHLADA	DS S/D BHIKHI	D370FL07	JASARWAL AP	AMR	OK	31.03.2023	AP 3Phase 3Wire				8223744	Not installed	2.466	NA	Director/D	
B.10201	West	BATHINDA	11KV	DS DIVN. BUDHLADA	DS S/D BHIKHI	D370FL05	Dhaipya	AMR	OK	31.03.2023	AP 3Phase 3Wire				8223775	Not installed	2.588	NA	Director/D	
B.10202	West	BATHINDA	11KV	DS DIVN. BUDHLADA	DS S/D BHIKHI	D370FL02	AMR	OK	31.03.2023	AP 3Phase 3Wire				3441261	Not installed	2.692	NA	Director/D		
B.10203	West	BATHINDA	11KV	DS DIVN. BUDHLADA	DS S/D BHIKHI	D370FL08	BHIKHI AP	NON AMR	OK	31.03.2023	AP 3Phase 3Wire				8223776	Not installed	2.875	NA	Director/D	
B.10204	West	BATHINDA	11KV	DS DIVN. BUDHLADA	DS S/D BHIKHI	D370FL13	Kotra UPS	AMR	OK	31.03.2023	Category 5-UPS				11117136	Not installed	3.433	NA	Director/D	
B.10205	West	BATHINDA	11KV	DS DIVN. BUDHLADA	DS S/D BHIKHI	D370FL09	Budhlada Road	AMR	OK	31.03.2023	Category 2				9534607	Not installed	8.039	NA	Director/D	
B.10206	West	BATHINDA	11KV	DS DIVN. BUDHLADA	DS S/D BHIKHI	D370FL11	hospital road	AMR	OK	31.03.2023	Category 1				10282826	Not installed	8.119	NA	Director/D	
B.10207	West	BATHINDA	11KV	DS DIVN. BUDHLADA	DS S/D BHIKHI	D370FL01	Khwa Khurad UPS	AMR	OK	31.03.2023	Category 5-UPS				7336387	Not installed	9.633	NA	Director/D	
B.10208	West	BATHINDA	11KV	DS DIVN. BUDHLADA	DS S/D BHIKHI	D370FL15	Bhali Urban	AMR	OK	31.03.2023	Category 1				210721	Not installed	12.585	NA	Director/D	
B.10209	West	BATHINDA	11KV	DS DIVN. BUDHLADA	DS S/D BHIKHI	D392FL01	BAPPIANA AP	AMR	OK	31.03.2023	AP 3Phase 3Wire				8223761	Not installed	2.090	NA	Director/D	
B.10210	West	BATHINDA	11KV	DS DIVN. BUDHLADA	DS S/D BHIKHI	FL19D392	Carnal Surjit Singh	NON AMR	OK	31.03.2023	AP 3Phase 3Wire				36797	100/5	2.100	NA	Director/D	
B.10211	West	BATHINDA	11KV	DS DIVN. BUDHLADA	DS S/D BHIKHI	X353FL12	Sant Baggia Singh	AMR	OK	31.03.2023	AP 3Phase 3Wire				33475	Not installed	0.701	NA	Director/D	
B.10212	West	BATHINDA	11KV	DS DIVN. BUDHLADA	DS S/D BHIKHI	X353FL11	Sunam Road AP (N)	AMR	OK	31.03.2023	AP 3Phase 3Wire				11052079	Not installed	1.776	NA	Director/D	
B.10213	West	BATHINDA	11KV	DS DIVN. BUDHLADA	DS S/D BHIKHI	X353FL06	Bhikhi Urban	AMR	OK	31.03.2023	AP 3Phase 3Wire				10283268	Not installed	1.841	NA	Director/D	
B.10214	West	BATHINDA	11KV	DS DIVN. BUDHLADA	DS S/D BHIKHI	Bik Dhani	AMR	OK	31.03.2023	AP 3Phase 3Wire				33396	Not installed	1.151	NA	Director/D		
B.10215	West	BATHINDA	11KV	DS DIVN. BUDHLADA	DS S/D BHIKHI	X353FL08	KHAWA ROAD	AMR	OK	31.03.2023	AP 3Phase 3Wire				11052007	Not installed	2.227	NA	Director/D	
B.10216	West	BATHINDA	11KV	DS DIVN. BUDHLADA	DS S/D BHIKHI	435311	Dwane Kohre	NON AMR	OK	31.03.2023	AP 3Phase 3Wire				33653	Not installed	2.254	NA	Director/D	
B.10217	West	BATHINDA	11KV	DS DIVN. BUDHLADA	DS S/D BHIKHI	X353FL03	BIR KHURD AP	NON AMR	OK	31.03.2023	AP 3Phase 3Wire				7042876	Not installed	2.295	NA	Director/D	
B.10218	West	BATHINDA	11KV	DS DIVN. BUDHLADA	DS S/D BHIKHI	X353FL02	BHIKHI ROAD	AMR	OK	31.03.2023	AP 3Phase 3Wire				7042825	Not installed	2.325	NA	Director/D	
B.10219	West	BATHINDA	11KV	DS DIVN. BUDHLADA	DS S/D BHIKHI	X353FL01	BIR KHURD AP	NON AMR	OK	31.03.2023	Category 1				7043666	Not installed	2.439	NA	Director/D	
B.10220	West	BATHINDA	11KV	DS DIVN. BUDHLADA	DS S/D BHIKHI	X353FL07	BIR KHURD UPS	AMR	OK	31.03.2023	Category 5-UPS				2067222	Not installed	3.635	NA	Director/D	
B.10221	West	BATHINDA	11KV	DS DIVN. BUDHLADA	DS S/D BHIKHI	D369FL07	Mohar Singh Wala	AMR	OK	31.03.2023	AP 3Phase 3Wire				2047055	Not installed	1.419	NA	Director/D	
B.10222	West	BATHINDA	11KV	DS DIVN. BUDHLADA	DS S/D BHIKHI	D369FL15	JHRI WALA	NON AMR	OK	31.03.2023	AP 3Phase 3Wire				1					

S.No	Zone	Circle	Voltage Level (kVA)	Division (kVA)	Sub-Division (kVA)	Feeder ID	Feeder Name	Feeder Metering Status (Metered/unmetered/AMR/AMI)	Status of Meter (Functional/Non-Functional)	Metering Date	Date of last actual meter reading/communication	Feeder Type (Agr/Industrial/Mixed)	Status of Communication			Period from 01.04.2021 to 31.03.2022				Sales	Remarks (Source of data)
													% data received through automatically if feeder AMR/AMI	Number of hours when meter was unable to communicate in overall	Total Number of hours in the period	Meter S.No	CT/PT ratio	Import (kWh)	Export (kWh)		
B.10252	West	BATHINDA	11KV	DS DIVN. BUDHLADA	DS S/D BOHA	0371FL01	Ganiwala AP	AMR	OK	31.03.2023		AP 3Phase 3Wire				8223764	Not installed	2,085	NA	Director/D	
B.10253	West	BATHINDA	11KV	DS DIVN. BUDHLADA	DS S/D BOHA	0371FL04	Satike	NON AMR	OK	31.03.2023		AP 3Phase 3Wire				8223763	Not installed	2,292	NA	Director/D	
B.10254	West	BATHINDA	11KV	DS DIVN. BUDHLADA	DS S/D BOHA	0371FL09	Gandhu Kalan	NON AMR	OK	31.03.2023		AP 3Phase 3Wire				34059	Not installed	2,323	NA	Director/D	
B.10255	West	BATHINDA	11KV	DS DIVN. BUDHLADA	DS S/D BOHA	0371FL05	Shekharwala	AMR	OK	31.03.2023		AP 3Phase 3Wire				365761	Not installed	2,369	NA	Director/D	
B.10256	West	BATHINDA	11KV	DS DIVN. BUDHLADA	DS S/D BOHA	0371FL02	Jolan	AMR	OK	31.03.2023		AP 3Phase 3Wire				4856	Not installed	2,416	NA	Director/D	
B.10257	West	BATHINDA	11KV	DS DIVN. BUDHLADA	DS S/D BOHA	0371FL17	GADDAR PATTI UPS	AMR	OK	31.03.2023		Category 5-UPS				36981	Not installed	2,462	NA	Director/D	
B.10258	West	BATHINDA	11KV	DS DIVN. BUDHLADA	DS S/D BOHA	0371FL07	Mander	AMR	OK	31.03.2023		AP 3Phase 3Wire				9154322	Not installed	3,217	NA	Director/D	
B.10259	West	BATHINDA	11KV	DS DIVN. BUDHLADA	DS S/D BOHA	0371FL06	Lakhwal	AMR	OK	31.03.2023		Category 5-UPS				4967	Not installed	8,018	NA	Director/D	
B.10260	West	BATHINDA	11KV	DS DIVN. BUDHLADA	DS S/D BOHA	0371FL05	Boha	NON AMR	OK	31.03.2023		Category 5-UPS				206693	Not installed	8,076	NA	Director/D	
B.10261	West	BATHINDA	11KV	DS DIVN. BUDHLADA	DS S/D BOHA	0371FL13	MAGHANAN UPS	AMR	OK	31.03.2023		Category 5-UPS				1519307	Not installed	8,936	NA	Director/D	
B.10262	West	BATHINDA	11KV	DS DIVN. BUDHLADA	DS S/D BOHA	0388FL05	Reond	AMR	OK	31.03.2023		AP 3Phase 3Wire				9153633	Not installed	1,553	NA	Director/D	
B.10263	West	BATHINDA	11KV	DS DIVN. BUDHLADA	DS S/D BOHA	0388FL12	11 KV Drain Wala AP	AMR	OK	31.03.2023		AP 3Phase 3Wire				1519377	Not installed	1,929	NA	Director/D	
B.10264	West	BATHINDA	11KV	DS DIVN. BUDHLADA	DS S/D BOHA	0388FL04	Andliamal	AMR	OK	31.03.2023		AP 3Phase 3Wire				9141162	Not installed	2,064	NA	Director/D	
B.10265	West	BATHINDA	11KV	DS DIVN. BUDHLADA	DS S/D BOHA	0388FL15	11 KV RAMGARH SHAHPURIA AP	AMR	OK	31.03.2023		AP 3Phase 3Wire				4713	Not installed	2,066	NA	Director/D	
B.10266	West	BATHINDA	11KV	DS DIVN. BUDHLADA	DS S/D BOHA	0388FL06	REOND PLOT	NON AMR	OK	31.03.2023		AP 3Phase 3Wire				10201977	Not installed	2,226	NA	Director/D	
B.10267	West	BATHINDA	11KV	DS DIVN. BUDHLADA	DS S/D BOHA	X351FL05	TAHLIAN URBAN	NON AMR	OK	31.03.2023		Category 1				9152765	Not installed	1,253	NA	Director/D	
B.10268	West	BATHINDA	11KV	DS DIVN. BUDHLADA	DS S/D BOHA	X351FL08	Madhal AP	AMR	OK	31.03.2023		AP 3Phase 3Wire				34231	Not installed	2,106	NA	Director/D	
B.10269	West	BATHINDA	11KV	DS DIVN. BUDHLADA	DS S/D BOHA	X351FL10	11 KV BABA NANAK AP	AMR	OK	31.03.2023		AP 3Phase 3Wire				3860	Not installed	2,312	NA	Director/D	
B.10270	West	BATHINDA	11KV	DS DIVN. BUDHLADA	DS S/D BOHA	X351FL02	ALAMPUR MANDRAN	NON AMR	OK	31.03.2023		AP 3Phase 3Wire				9154435	Not installed	2,376	NA	Director/D	
B.10271	West	BATHINDA	11KV	DS DIVN. BUDHLADA	DS S/D BOHA	X351FL01	BHATNAL AP	NON AMR	OK	31.03.2023		AP 3Phase 3Wire				9154479	Not installed	2,552	NA	Director/D	
B.10272	West	BATHINDA	11KV	DS DIVN. BUDHLADA	DS S/D BOHA	X351FL07	Phulu Wala AP	AMR	OK	31.03.2023		AP 3Phase 3Wire				36966	Not installed	3,048	NA	Director/D	
B.10273	West	BATHINDA	11KV	DS DIVN. BUDHLADA	DS S/D BOHA	X351FL09	GULAB SINGH WALA	NON AMR	OK	31.03.2023		AP 3Phase 3Wire				3096	Not installed	3,316	NA	Director/D	
B.10274	West	BATHINDA	11KV	DS DIVN. BUDHLADA	DS S/D BOHA	X351FL04	MAL SINGH WALA UPS	AMR	OK	31.03.2023		Category 5-UPS				9154396	Not installed	6,223	NA	Director/D	
B.10275	West	BATHINDA	11KV	DS DIVN. BUDHLADA	DS S/D BOHA	X351FL11	11 KV CHEENA UPS	AMR	OK	31.03.2023		Category 5-UPS				4440	Not installed	6,347	NA	Director/D	
B.10276	West	BATHINDA	11KV	DS DIVN. BUDHLADA	DS S/D BUDHLADA	0399FL05	BHADRA AP	AMR	OK	31.03.2023		AP 3Phase 3Wire				9534543	900-450/577/1-1-1	1,674	NA	Director/D	
B.10277	West	BATHINDA	11KV	DS DIVN. BUDHLADA	DS S/D BUDHLADA	0399FL12	Baba Mastan	AMR	OK	31.03.2023		AP 3Phase 3Wire				37205	900-450/577/1-1-1	1,818	NA	Director/D	
B.10278	West	BATHINDA	11KV	DS DIVN. BUDHLADA	DS S/D BUDHLADA	0399FL04	BHADRA URBAN	AMR	OK	31.03.2023		Category 1				9534513	Not installed	2,136	NA	Director/D	
B.10279	West	BATHINDA	11KV	DS DIVN. BUDHLADA	DS S/D BUDHLADA	0399FL09	Baba Mastan Dass AP	AMR	OK	31.03.2023		AP 3Phase 3Wire				24324	900-450/577/1-1-1	2,255	NA	Director/D	
B.10280	West	BATHINDA	11KV	DS DIVN. BUDHLADA	DS S/D BUDHLADA	0399FL02	NATHA SINGH WALA	AMR	OK	31.03.2023		AP 3Phase 3Wire				9534605	Not installed	2,453	NA	Director/D	
B.10281	West	BATHINDA	11KV	DS DIVN. BUDHLADA	DS S/D BUDHLADA	0399FL11	kanakwal	AMR	OK	31.03.2023		AP 3Phase 3Wire				33606	900-450/577/1-1-1	2,662	NA	Director/D	
B.10282	West	BATHINDA	11KV	DS DIVN. BUDHLADA	DS S/D BUDHLADA	0399FL10	Alampur UPS	NON AMR	OK	31.03.2023		Category 5-UPS				24275	900-450/577/1-1-1	2,795	NA	Director/D	
B.10283	West	BATHINDA	11KV	DS DIVN. BUDHLADA	DS S/D BUDHLADA	0399FL06	Baba Jabbar Nath AP	AMR	OK	31.03.2023		AP 3Phase 3Wire				1257280	Not installed	2,874	NA	Director/D	
B.10284	West	BATHINDA	11KV	DS DIVN. BUDHLADA	DS S/D BUDHLADA	0399FL03	Alampur New	AMR	OK	31.03.2023		AP 3Phase 3Wire				9534564	Not installed	3,125	NA	Director/D	
B.10285	West	BATHINDA	11KV	DS DIVN. BUDHLADA	DS S/D BUDHLADA	0399FL01	BUNGA SAHIB UPS	AMR	OK	31.03.2023		Category 5-UPS				9534454	900-450/577/1-1-1	11,461	NA	Director/D	
B.10286	West	BATHINDA	11KV	DS DIVN. BUDHLADA	DS S/D BUDHLADA	0399FL14	DHARMEANA	AMR	OK	31.03.2023		AP 3Phase 3Wire				23375	Not installed	0,140	NA	Director/D	
B.10287	West	BATHINDA	11KV	DS DIVN. BUDHLADA	DS S/D BUDHLADA	0399FL07	SANT SURESHA NAND	AMR	OK	31.03.2023		AP 3Phase 3Wire				11052062	Not installed	2,206	NA	Director/D	
B.10288	West	BATHINDA	11KV	DS DIVN. BUDHLADA	DS S/D BUDHLADA	0399FL02	Khillan AP	AMR	OK	31.03.2023		AP 3Phase 3Wire				8223771	Not installed	2,266	NA	Director/D	
B.10289	West	BATHINDA	11KV	DS DIVN. BUDHLADA	DS S/D BUDHLADA	0399FL08	Bhai Bahlan AP	AMR	OK	31.03.2023		AP 3Phase 3Wire				1257285	Not installed	2,387	NA	Director/D	
B.10290	West	BATHINDA	11KV	DS DIVN. BUDHLADA	DS S/D BUDHLADA	0399FL05	JETGARH AP	AMR	OK	31.03.2023		AP 3Phase 3Wire				9141164	Not installed	2,515	NA	Director/D	
B.10291	West	BATHINDA	11KV	DS DIVN. BUDHLADA	DS S/D BUDHLADA	0399FL03	Borawal AP	AMR	OK	31.03.2023		AP 3Phase 3Wire				8223762	Not installed	2,808	NA	Director/D	
B.10292	West	BATHINDA	11KV	DS DIVN. BUDHLADA	DS S/D BUDHLADA	0399FL11	11 KV Dera Beas	AMR	OK	31.03.2023		AP 3Phase 3Wire				36795	100/5-5	2,916	NA	Director/D	
B.10293	West	BATHINDA	11KV	DS DIVN. BUDHLADA	DS S/D BUDHLADA	0399FL12	Budhpura AP	AMR	OK	31.03.2023		AP 3Phase 3Wire				23375	100/5-5	3,216	NA	Director/D	
B.10294	West	BATHINDA	11KV	DS DIVN. BUDHLADA	DS S/D BUDHLADA	0399FL06	Borawal ROAD	AMR	OK	31.03.2023		Category 1				7002859	Not installed	3,425	NA	Director/D	
B.10295	West	BATHINDA	11KV	DS DIVN. BUDHLADA	DS S/D BUDHLADA	0399FL13	PHARWAH ROAD	AMR	OK	31.03.2023		Category 5-UPS				3182	100/5-5	6,003	NA	Director/D	
B.10296	West	BATHINDA	11KV	DS DIVN. BUDHLADA	DS S/D BUDHLADA	0399FL04	Gurne UPS	NON AMR	OK	31.03.2023		Category 5-UPS				7042858	Not installed	7,501	NA	Director/D	
B.10297	West	BATHINDA	11KV	DS DIVN. BUDHLADA	DS S/D BUDHLADA	0367FL25	66KV substation Budhlada	AMR	OK	31.03.2023		Substation Transformer				184	Not installed	0,036	NA	Director/D	
B.10298	West	BATHINDA	11KV	DS DIVN. BUDHLADA	DS S/D BUDHLADA	0367FL20	Sant Prem Das	AMR	OK	31.03.2023		AP 3Phase 3Wire				3628	Not installed	1,599	NA	Director/D	
B.10299	West	BATHINDA	11KV	DS DIVN. BUDHLADA	DS S/D BUDHLADA	0367FL19	BIRU GHAR	AMR	OK	31.03.2023		AP 3Phase 3Wire				8222831	Not installed	1,605	NA	Director/D	
B.10300	West	BATHINDA	11KV	DS DIVN. BUDHLADA	DS S/D BUDHLADA	0367FL03	Phapha	NON AMR	OK	31.03.2023		AP 3Phase 3Wire				3983	Not installed	1,846	NA	Director/D	
B.10301	West	BATHINDA	11KV	DS DIVN. BUDHLADA	DS S/D BUDHLADA	0367FL18	GURNE AP	AMR	OK	31.03.2023		AP 3Phase 3Wire				30333607	Not installed	2,356	NA	Director/D	
B.10302	West	BATHINDA	11KV	DS DIVN. BUDHLADA	DS S/D BUDHLADA	0367FL16	Choa AP	AMR	OK	31.03.2023		AP 3Phase 3Wire				12093520	Not installed	2,449	NA	Director/D	
B.10303	West	BATHINDA	11KV	DS DIVN. BUDHLADA	DS S/D BUDHLADA	0367FL05	BACHHUANA	AMR	OK	31.03.2023		AP 3Phase 3Wire				8222832	Not installed	2,589	NA	Director/D	
B.10304	West	BATHINDA	11KV	DS DIVN. BUDHLADA	DS S/D BUDHLADA	0367FL02	BANUPUR AP	AMR	OK	31.03.2023		AP 3Phase 3Wire				37162	Not installed	2,645	NA	Director/D	
B.10305	West	BATHINDA	11KV	DS DIVN. BUDHLADA	DS S/D BUDHLADA	0367FL11	HASANPUR AP	AMR	OK	31.03.2023		AP 3Phase 3Wire				37168	Not installed	2,701	NA	Director/D	
B.10306	West	BATHINDA	11KV	DS DIVN. BUDHLADA	DS S/D BUDHLADA	0367FL07	CHAK BHAI KE AP	AMR	OK	31.03.2023		AP 3Phase 3Wire				2066508	Not installed	2,851	NA	Director/D	
B.10307	West	BATHINDA	11KV	DS DIVN. BUDHLADA	DS S/D BUDHLADA	0367FL09	Kulehrn	AMR	OK	31.03.2023		AP 3Phase 3Wire				37219	Not installed	2,854	NA	Director/D	
B.10308	West	BATHINDA	11KV	DS DIVN. BUDHLADA	DS S/D BUDHLADA	0367FL11	Ralli	AMR	OK	31.03.2023		AP 3Phase 3Wire				910284	Not installed	2,928	NA	Director/D	
B.10309	West	BATHINDA	11KV	DS DIVN. BUDHLADA	DS S/D BUDHLADA	0367FL04	Dodra	NON AMR	OK	31.03.2023		AP 3Phase 3Wire				37027	Not installed	2,954	NA	Director/D	
B.10310	West	BATHINDA	11KV	DS DIVN. BUDHLADA	DS S/D BUDHLADA	0367FL17	Bahar AP	AMR	OK	31.03.2023		AP 3Phase 3Wire				3102669	Not installed	3,521	NA	Director/D	
B.10311	West	BATHINDA	11KV	DS DIVN. BUDHLADA	DS S/D BUDHLADA	11KV TAI PALACE ROAD		AMR	OK	31.03.2023		Category 1				4911	Not installed	3,589	NA	Director/D	
B.10312	West	BATHINDA	11KV	DS DIVN. BUDHLADA	DS S/D BUDHLADA	0367FL01	COLLEGE ROAD URBAN	AMR	OK	31.03.2023		Category 1				37140	Not installed	4,857	NA	Director/D	
B.10313	West	BATHINDA	11KV	DS DIVN. BUDHLADA	DS S/D BUDHLADA	0367FL10	Aeshampur UPS	AMR	OK	31.03.2023		Category 5-UPS				37163	Not installed	6,943	NA	Director/D	
B.10314	West	BATHINDA	11KV	DS DIVN. BUDHLADA	DS S/D BUDHLADA	0367FL06	Boha Road	NON AMR	OK	31.03.2023		Category 1				37204	Not installed	7,787	NA	Director/D	
B.10315	West	BATHINDA	11KV	DS DIVN. BUDHLADA	DS S/D BUDHLADA	0367FL13	11 KV H P Road	AMR	OK	31.03.2023		Category 1				13190562	Not installed	8,146	NA	Director/D	
B.10316	West	BATHINDA	11KV	DS DIVN. BUDHLADA	DS S/D BUDHLADA	0367FL08	Budhlada URBAN	AMR	OK	31.03.2023		Category 1				2998	Not installed	11,095	NA	Director/D	
B.10317	West	BATHINDA	11KV	DS DIVN. BUDHLADA	DS S/D BUDHLADA	0367FL05	Bus Stand Road	AMR	OK	31.03.2023		Category 1				11168802	Not installed	13,878	NA	Director/D	
B.10318	West	BATHINDA</																			

S.No	Zone	Circle	Voltage Level (kVA)	Division (kVA)	Sub-Division (kVA)	Feeder ID	Feeder Name	Feeder Metering Status (Metered/unmetered/AMR/AMI)	Status of Meter (Functional/Non-Functional)	Metering Date (Date of last actual meter reading/communication)	Feeder Type (Agr/Industrial/Mixed)	Status of Communication			Period from 01.04.2021 to 31.03.2022				Sales	Remarks (Source of data)
												% data received through automatically if feeder AMR/AMI	Number of hours when meter was unable to communicate in overall	Total Number of hours in the period	Meter S.No	CT/PT ratio	Import (kU)	Export (kU)		
B.10349	West	BATHINDA	11KV	D5 DIVN. MANS	D5 CITY S/D MANS	K37201	Baba Rangli Ram	AMR	OK	31.03.2023	Category 5-UPS				15196569	Not installed	4.843	NA	Director/D	
B.10350	West	BATHINDA	11KV	D5 DIVN. MANS	D5 CITY S/D MANS	D363FL14	Baba Jawahar Dass	AMR	OK	31.03.2023	AP 3Phase 3Wire				11052060	Not installed	1.260	NA	Director/D	
B.10351	West	BATHINDA	11KV	D5 DIVN. MANS	D5 CITY S/D MANS	D363FL04	NANGAL KHURD	AMR	OK	31.03.2023	AP 3Phase 3Wire				11052060	Not installed	1.334	NA	Director/D	
B.10352	West	BATHINDA	11KV	D5 DIVN. MANS	D5 CITY S/D MANS	D363FL03	NARBERPURA	AMR	OK	31.03.2023	AP 3Phase 3Wire				8873349	Not installed	1.568	NA	Director/D	
B.10353	West	BATHINDA	11KV	D5 DIVN. MANS	D5 CITY S/D MANS	D363FL00	Banala	AMR	OK	31.03.2023	AP 3Phase 3Wire				11052077	Not installed	2.170	NA	Director/D	
B.10354	West	BATHINDA	11KV	D5 DIVN. MANS	D5 CITY S/D MANS	D363FL02	AKKANWALI	AMR	OK	31.03.2023	AP 3Phase 3Wire				2067903	900-450/577/1-1	2.850	NA	Director/D	
B.10355	West	BATHINDA	11KV	D5 DIVN. MANS	D5 CITY S/D MANS	D363FL10	DELIANA	AMR	OK	31.03.2023	Category 5-UPS				2065508	Not installed	5.407	NA	Director/D	
B.10356	West	BATHINDA	11KV	D5 DIVN. MANS	D5 CITY S/D MANS	D363FL07	HIRE WALA	NON AMR	OK	31.03.2023	Category 5-UPS				3190598	Not installed	8.698	NA	Director/D	
B.10357	West	BATHINDA	11KV	D5 DIVN. MANS	D5 CITY S/D MANS	D361FL15	CIVIL HOSPITALS	AMR	OK	31.03.2023	Category 4				9568256	Not installed	0.296	NA	Director/D	
B.10358	West	BATHINDA	11KV	D5 DIVN. MANS	D5 CITY S/D MANS	D363FL08	INDUSTRIAL	AMR	OK	31.03.2023	Category 1				9568300	Not installed	4.105	NA	Director/D	
B.10359	West	BATHINDA	11KV	D5 DIVN. MANS	D5 CITY S/D MANS	D363FL09	CITY MANS	AMR	OK	31.03.2023	Category 1				9568300	Not installed	5.479	NA	Director/D	
B.10360	West	BATHINDA	11KV	D5 DIVN. MANS	D5 CITY S/D MANS	D363FL02	BHAI GURDAS	AMR	OK	31.03.2023	Category 1				9568175	Not installed	6.590	NA	Director/D	
B.10361	West	BATHINDA	11KV	D5 DIVN. MANS	D5 CITY S/D MANS	D361FL13	TIRVENI	AMR	OK	31.03.2023	Category 1				17052069	Not installed	7.839	NA	Director/D	
B.10362	West	BATHINDA	11KV	D5 DIVN. MANS	D5 CITY S/D MANS	D361FL01	WATER WORKS	NON AMR	OK	31.03.2023	Category 1				9568125	Not installed	7.933	NA	Director/D	
B.10363	West	BATHINDA	11KV	D5 DIVN. MANS	D5 CITY S/D MANS	D361FL07	CHAKRIARI	Not available	OK	31.03.2023	AP 3Phase 3Wire				37114	900-450/577/1-1	2.585	NA	Director/D	
B.10364	West	BATHINDA	6KV	D5 DIVN. MANS	D5 CITY S/D MANS	D363C-2	Silbiu Splinex	AMR	OK	31.03.2023	Category 4				Not available	Not available	16.998	NA	Director/D	
B.10365	West	BATHINDA	11KV	D5 DIVN. MANS	D5 S/D JHUNIR	B366FL17	SHEETALSAR	AMR	OK	31.03.2023	AP 3Phase 3Wire				4328	200-100/5-5	1.201	NA	Director/D	
B.10366	West	BATHINDA	11KV	D5 DIVN. MANS	D5 S/D JHUNIR	B366FL16	FATTA MALOKA	AMR	OK	31.03.2023	AP 3Phase 3Wire				16194402	200-100/5-5	1.462	NA	Director/D	
B.10367	West	BATHINDA	11KV	D5 DIVN. MANS	D5 S/D JHUNIR	B366FL02	MAKHE WALA	AMR	OK	31.03.2023	AP 3Phase 3Wire				10288317	1200/577/1-1	1.624	NA	Director/D	
B.10368	West	BATHINDA	11KV	D5 DIVN. MANS	D5 S/D JHUNIR	B366FL04	MOFFER	AMR	OK	31.03.2023	AP 3Phase 3Wire				11052028	1200/577/1-1	1.346	NA	Director/D	
B.10369	West	BATHINDA	11KV	D5 DIVN. MANS	D5 S/D JHUNIR	B366FL12	Chainewala	AMR	OK	31.03.2023	AP 3Phase 3Wire				34116	200-100/5-5	2.092	NA	Director/D	
B.10370	West	BATHINDA	11KV	D5 DIVN. MANS	D5 S/D JHUNIR	B366FL06	CHURHA	AMR	OK	31.03.2023	AP 3Phase 3Wire				10288316	200-100/5-5	2.210	NA	Director/D	
B.10371	West	BATHINDA	11KV	D5 DIVN. MANS	D5 S/D JHUNIR	B366FL10	11kv jataa Khurd(Old Fatehpur)	AMR	OK	31.03.2023	AP 3Phase 3Wire				13190575	200-100/5-5	2.308	NA	Director/D	
B.10372	West	BATHINDA	11KV	D5 DIVN. MANS	D5 S/D JHUNIR	B366FL01	GHURKANI	AMR	OK	31.03.2023	AP 3Phase 3Wire				12092505	200-100/5-5	2.377	NA	Director/D	
B.10373	West	BATHINDA	11KV	D5 DIVN. MANS	D5 S/D JHUNIR	B366FL08	Chuduwala	AMR	OK	31.03.2023	AP 3Phase 3Wire				33493	200-100/5-5	2.718	NA	Director/D	
B.10374	West	BATHINDA	11KV	D5 DIVN. MANS	D5 S/D JHUNIR	B366FL11	Korwala	AMR	OK	31.03.2023	AP 3Phase 3Wire				12517384	200-100/5-5	3.118	NA	Director/D	
B.10375	West	BATHINDA	11KV	D5 DIVN. MANS	D5 S/D JHUNIR	B366FL07	UPS-I	AMR	OK	31.03.2023	Category 5-UPS				10288322	1200/577/1-1	5.340	NA	Director/D	
B.10376	West	BATHINDA	11KV	D5 DIVN. MANS	D5 S/D JHUNIR	B366FL03	Sahnewali UPS III	AMR	OK	31.03.2023	Category 5-UPS				10282986	1200/577/1-1	6.548	NA	Director/D	
B.10377	West	BATHINDA	11KV	D5 DIVN. MANS	D5 S/D JHUNIR	B366FL09	JHUNIR	AMR	OK	31.03.2023	Category 1				102391	200-100/5-5	7.521	NA	Director/D	
B.10378	West	BATHINDA	11KV	D5 DIVN. MANS	D5 S/D JHUNIR	B366FL05	UPS-II	AMR	OK	31.03.2023	Category 5-UPS				10282908	200-100/5-5	10.562	NA	Director/D	
B.10379	West	BATHINDA	11KV	D5 DIVN. MANS	D5 S/D JHUNIR	D366FL01	AKHILE URBAN	AMR	OK	31.03.2023	Category 1				9154074	900-450/577/1-1	1.092	NA	Director/D	
B.10380	West	BATHINDA	11KV	D5 DIVN. MANS	D5 S/D JHUNIR	D366FL07	AKASAR	AMR	OK	31.03.2023	AP 3Phase 2Wire				345204	900-450/577/1-1	2.000	NA	Director/D	
B.10381	West	BATHINDA	11KV	D5 DIVN. MANS	D5 S/D JHUNIR	D366FL06	Bain	AMR	OK	31.03.2023	AP 3Phase 3Wire				12093446	Not installed	2.254	NA	Director/D	
B.10382	West	BATHINDA	11KV	D5 DIVN. MANS	D5 S/D JHUNIR	D366FL09	Heerke	AMR	OK	31.03.2023	AP 3Phase 3Wire				27738	900-450/577/1-1	2.385	NA	Director/D	
B.10383	West	BATHINDA	11KV	D5 DIVN. MANS	D5 S/D JHUNIR	D366FL12	GHAGAR	AMR	OK	31.03.2023	AP 3Phase 3Wire				15193794	Not installed	2.452	NA	Director/D	
B.10384	West	BATHINDA	11KV	D5 DIVN. MANS	D5 S/D JHUNIR	D366FL14	HANDJUKI	AMR	OK	31.03.2023	AP 3Phase 3Wire				9154089	Not installed	2.589	NA	Director/D	
B.10385	West	BATHINDA	11KV	D5 DIVN. MANS	D5 S/D JHUNIR	D366FL03	CHOTAN	AMR	OK	31.03.2023	AP 3Phase 3Wire				9154092	900-450/577/1-1	2.425	NA	Director/D	
B.10386	West	BATHINDA	11KV	D5 DIVN. MANS	D5 S/D JHUNIR	D366FL02	ALLIKE	AMR	OK	31.03.2023	Category 5-UPS				9154176	Not installed	9.935	NA	Director/D	
B.10387	West	BATHINDA	11KV	D5 DIVN. MANS	D5 S/D JHUNIR	K371FL07	DANEWALA URBAN	AMR	OK	31.03.2023	Category 1				3263	Not installed	1.030	NA	Director/D	
B.10388	West	BATHINDA	11KV	D5 DIVN. MANS	D5 S/D JHUNIR	K371FL08	Moffar UPS	NON AMR	OK	31.03.2023	Category 5-UPS				4243	Not installed	1.142	NA	Director/D	
B.10389	West	BATHINDA	11KV	D5 DIVN. MANS	D5 S/D JHUNIR	K371FL05	MODA	AMR	OK	31.03.2023	AP 3Phase 3Wire				16198443	Not installed	1.881	NA	Director/D	
B.10390	West	BATHINDA	11KV	D5 DIVN. MANS	D5 S/D JHUNIR	K371FL09	KRUTA	AMR	OK	31.03.2023	AP 3Phase 3Wire				4239	Not installed	2.162	NA	Director/D	
B.10391	West	BATHINDA	11KV	D5 DIVN. MANS	D5 S/D JHUNIR	K371FL04	Kaithal	AMR	OK	31.03.2023	AP 3Phase 3Wire				15193847	Not installed	2.311	NA	Director/D	
B.10392	West	BATHINDA	11KV	D5 DIVN. MANS	D5 S/D JHUNIR	K371FL-3	SANDU	NON AMR	OK	31.03.2023	AP 3Phase 3Wire				15194845	Not installed	2.359	NA	Director/D	
B.10393	West	BATHINDA	11KV	D5 DIVN. MANS	D5 S/D JHUNIR	K371FL06	MALKO	AMR	OK	31.03.2023	AP 3Phase 3Wire				2631	Not installed	2.452	NA	Director/D	
B.10394	West	BATHINDA	11KV	D5 DIVN. MANS	D5 S/D JHUNIR	K371FL-2	Fardiky	AMR	OK	31.03.2023	Category 5-UPS				15194669	Not installed	2.582	NA	Director/D	
B.10395	West	BATHINDA	11KV	D5 DIVN. MANS	D5 S/D JHUNIR	K371FL01	Nandh garh	AMR	OK	31.03.2023	Category 5-UPS				123456	Not installed	7.913	NA	Director/D	
B.10396	West	BATHINDA	11KV	D5 DIVN. MANS	D5 S/D JHUNIR	D363FL06	ANANDGARH	AMR	OK	31.03.2023	AP 3Phase 3Wire				8222382	900-450/577/1-1	2.022	NA	Director/D	
B.10397	West	BATHINDA	11KV	D5 DIVN. MANS	D5 S/D JHUNIR	D363FL08	Bhamme kalan	AMR	OK	31.03.2023	AP 3Phase 3Wire				7312286	900-450/577/1-1	2.437	NA	Director/D	
B.10398	West	BATHINDA	11KV	D5 DIVN. MANS	D5 S/D JHUNIR	D363FL11	KOT DHARMU URBAN	AMR	OK	31.03.2023	Category 1				8222832	900-450/577/1-1	3.140	NA	Director/D	
B.10399	West	BATHINDA	11KV	D5 DIVN. MANS	D5 S/D JHUNIR	D363FL01	KOT DHARMU UPS	AMR	OK	31.03.2023	Category 5-UPS				11052082	Not installed	6.834	NA	Director/D	
B.10400	West	BATHINDA	11KV	D5 DIVN. MANS	D5 S/D JOGA	D365FL03	UBHA (AP)	AMR	OK	31.03.2023	AP 3Phase 3Wire				8223665	Not installed	1.848	NA	Director/D	
B.10401	West	BATHINDA	11KV	D5 DIVN. MANS	D5 S/D JOGA	D365FL18	DETA SINGHANA	AMR	OK	31.03.2023	AP 3Phase 3Wire				15193895	Not installed	1.914	NA	Director/D	
B.10402	West	BATHINDA	11KV	D5 DIVN. MANS	D5 S/D JOGA	D365FL19	BOHARAN WALA	AMR	OK	31.03.2023	AP 3Phase 3Wire				15193917	Not installed	1.989	NA	Director/D	
B.10403	West	BATHINDA	11KV	D5 DIVN. MANS	D5 S/D JOGA	D365FL11	BHUPAL	NON AMR	OK	31.03.2023	AP 3Phase 3Wire				9154177	Not installed	2.011	NA	Director/D	
B.10404	West	BATHINDA	11KV	D5 DIVN. MANS	D5 S/D JOGA	D365FL13	Gausalka	AMR	OK	31.03.2023	AP 3Phase 3Wire				12527363	Not installed	2.233	NA	Director/D	
B.10405	West	BATHINDA	11KV	D5 DIVN. MANS	D5 S/D JOGA	D365FL16	11 K.V. KALRA WALA	AMR	OK	31.03.2023	AP 3Phase 3Wire				15194795	Not installed	2.304	NA	Director/D	
B.10406	West	BATHINDA	11KV	D5 DIVN. MANS	D5 S/D JOGA	D365FL01	Makha chahlan	AMR	OK	31.03.2023	AP 3Phase 3Wire				2066337	Not installed	2.373	NA	Director/D	
B.10407	West	BATHINDA	11KV	D5 DIVN. MANS	D5 S/D JOGA	D365FL14	Kaithal	NON AMR	OK	31.03.2023	AP 3Phase 3Wire				112093482	Not installed	2.396	NA	Director/D	
B.10408	West	BATHINDA	11KV	D5 DIVN. MANS	D5 S/D JOGA	D365FL21	ANODPGARH AP	AMR	OK	31.03.2023	AP 3Phase 3Wire				7424100	Not installed	2.463	NA	Director/D	
B.10409	West																			

S.No	Zone	Circle	Voltage Level (kVA)	Division (kVA)	Sub-Division (kVA)	Feeder ID	Feeder Name	Feeder Metering Status (Metered/unmetered/AMR/AMI)	Status of Meter (Functional/Non-Functional)	Metering Date (Date of last actual meter reading/communication)	Feeder Type (Agr/Industrial/Mixed)	Status of Communication		Period from 01.04.2021 to 31.03.2022				Sales	Remarks (Source of data)
												% data received through automatically if feeder AMR/AMI	Number of hours when meter was unable to communicate in overall	Total Number of hours in the period	Meter S.No	CT/PT ratio	Import (kWh)		
B.10446	West	BATHINDA	11KV	DS DIVN. MANSA	DS S/D SURDULGARH	0366FL10	Baba Amar Singh Kirti	NON AMR	OK	31.03.2023	AP 3Phase 3Wire			23651	900-450/577/1-1-1	2.544	NA	Director/D	
B.10447	West	BATHINDA	11KV	DS DIVN. MANSA	DS S/D SURDULGARH	0366FL08	Mirpur Kalan (Alike Grid)	NON AMR	OK	31.03.2023	Category 5-U/PS			23636	Not installed	6.250	NA	Director/D	
B.10448	West	BATHINDA	11KV	DS DIVN. MANSA	DS S/D SURDULGARH	KAHNFLO5	KaInevaa Urban	NON AMR	OK	31.03.2023	Category 1			120183	900-450/577/1-1-1	0.784	NA	Director/D	
B.10449	West	BATHINDA	11KV	DS DIVN. MANSA	DS S/D SURDULGARH	0366FL01	NON AMR	OK	31.03.2023	Category 5-U/PS			703132735	900-450/577/1-1-1	1.909	NA	Director/D		
B.10450	West	BATHINDA	11KV	DS DIVN. MANSA	DS S/D SURDULGARH	KAHNFLO2	ROKRI	AMR	OK	31.03.2023	AP 3Phase 3Wire			9153615	900-450/577/1-1-1	2.254	NA	Director/D	
B.10451	West	BATHINDA	11KV	DS DIVN. MANSA	DS S/D SURDULGARH	KAHNFLO8	BABA BADRI DASS	AMR	OK	31.03.2023	AP 3Phase 3Wire			33612	900-450/577/1-1-1	2.403	NA	Director/D	
B.10452	West	BATHINDA	11KV	DS DIVN. MANSA	DS S/D SURDULGARH	KAHNFLO4	AMAR DASS	NON AMR	OK	31.03.2023	AP 3Phase 3Wire			9154064	900-450/577/1-1-1	2.451	NA	Director/D	
B.10453	West	BATHINDA	11KV	DS DIVN. MANSA	DS S/D SURDULGARH	7905FL07	New Bhunder	AMR	OK	31.03.2023	AP 3Phase 3Wire			73112880	900-450/577/1-1-1	2.485	NA	Director/D	
B.10454	West	BATHINDA	11KV	DS DIVN. MANSA	DS S/D SURDULGARH	KAHNFLO3	HIAND DASS	AMR	OK	31.03.2023	AP 3Phase 3Wire			91541158	900-450/577/1-1-1	2.501	NA	Director/D	
B.10455	West	BATHINDA	11KV	DS DIVN. MANSA	DS S/D SURDULGARH	KAHNFLO1	KAHNWAL	AMR	OK	31.03.2023	Category 5-U/PS			9153630	900-450/577/1-1-1	5.890	NA	Director/D	
B.10456	West	BATHINDA	11KV	DS DIVN. MANSA	DS S/D SURDULGARH	X85FL01	AHLUPUR	AMR	OK	31.03.2023	AP 3Phase 3Wire			16194411	900-450/577/1-1-1	2.256	NA	Director/D	
B.10457	West	BATHINDA	11KV	DS DIVN. MANSA	DS S/D SURDULGARH	X85FL02	KHERA ROAD	NON AMR	OK	31.03.2023	AP 3Phase 3Wire			16194410	900-450/577/1-1-1	2.336	NA	Director/D	
B.10458	West	BATHINDA	11KV	DS DIVN. MANSA	DS S/D SURDULGARH	X85FL04	Dhingana	AMR	OK	31.03.2023	AP 3Phase 3Wire			16194422	900-450/577/1-1-1	2.373	NA	Director/D	
B.10459	West	BATHINDA	11KV	DS DIVN. MANSA	DS S/D SURDULGARH	X85FL03	AHLUPUR	AMR	OK	31.03.2023	Category 5-U/PS			16194407	900-450/577/1-1-1	6.797	NA	Director/D	
B.10460	West	BATHINDA	11KV	DS DIVN. MANSA	DS S/D SURDULGARH	E35FL08	COHAR KHERA	AMR	OK	31.03.2023	AP 3Phase 3Wire			8223751	Not installed	1.992	NA	Director/D	
B.10461	West	BATHINDA	11KV	DS DIVN. MANSA	DS S/D SURDULGARH	E35FL07	KARNDI	AMR	OK	31.03.2023	AP 3Phase 3Wire			5388141	Not installed	2.172	NA	Director/D	
B.10462	West	BATHINDA	11KV	DS DIVN. MANSA	DS S/D SURDULGARH	E35FL05	SANGHA	AMR	OK	31.03.2023	AP 3Phase 3Wire			8223752	Not installed	2.354	NA	Director/D	
B.10463	West	BATHINDA	11KV	DS DIVN. MANSA	DS S/D SURDULGARH	E35FL01	RARANA	AMR	OK	31.03.2023	AP 3Phase 3Wire			8223755	Not installed	2.651	NA	Director/D	
B.10464	West	BATHINDA	11KV	DS DIVN. MANSA	DS S/D SURDULGARH	E35FL11	DING ROAD	AMR	OK	31.03.2023	AP 3Phase 3Wire			12092484	Not installed	2.667	NA	Director/D	
B.10465	West	BATHINDA	11KV	DS DIVN. MANSA	DS S/D SURDULGARH	E35SG07	11 kv MOKAL AP	NON AMR	OK	31.03.2023	AP 3Phase 3Wire			4666	Not installed	2.742	NA	Director/D	
B.10466	West	BATHINDA	11KV	DS DIVN. MANSA	DS S/D SURDULGARH	E35SG05	Baba Ramdev J	AMR	OK	31.03.2023	AP 3Phase 3Wire			2634	Not installed	2.934	NA	Director/D	
B.10467	West	BATHINDA	11KV	DS DIVN. MANSA	DS S/D SURDULGARH	E35FL12	Naharan	AMR	OK	31.03.2023	AP 3Phase 3Wire			23473	Not installed	2.968	NA	Director/D	
B.10468	West	BATHINDA	11KV	DS DIVN. MANSA	DS S/D SURDULGARH	E35FL09	RANGOI	AMR	OK	31.03.2023	AP 3Phase 3Wire			8223753	Not installed	3.097	NA	Director/D	
B.10469	West	BATHINDA	11KV	DS DIVN. MANSA	DS S/D SURDULGARH	E35FL13	SOTAR	AMR	OK	31.03.2023	AP 3Phase 3Wire			12092470	Not installed	3.111	NA	Director/D	
B.10470	West	BATHINDA	11KV	DS DIVN. MANSA	DS S/D SURDULGARH	E35FL03	JANAMJIT	NON AMR	OK	31.03.2023	AP 3Phase 3Wire			8223754	Not installed	3.383	NA	Director/D	
B.10471	West	BATHINDA	11KV	DS DIVN. MANSA	DS S/D SURDULGARH	E35SG06	Bhawanji Road AP	AMR	OK	31.03.2023	AP 3Phase 3Wire			2629	Not installed	3.385	NA	Director/D	
B.10472	West	BATHINDA	11KV	DS DIVN. MANSA	DS S/D SURDULGARH	E35FL02	MANKHERA	NON AMR	OK	31.03.2023	AP 3Phase 3Wire			234713	Not installed	4.037	NA	Director/D	
B.10473	West	BATHINDA	11KV	DS DIVN. MANSA	DS S/D SURDULGARH	E35FL10	BHAGIPIR URBAN	NON AMR	OK	31.03.2023	Category 1			12092485	Not installed	4.065	NA	Director/D	
B.10474	West	BATHINDA	11KV	DS DIVN. MANSA	DS S/D SURDULGARH	E35FL04	BHAGIPIPER	AMR	OK	31.03.2023	Category 5-U/PS			2068719	Not installed	6.710	NA	Director/D	
B.10475	West	BATHINDA	11KV	DS DIVN. MANSA	DS S/D SURDULGARH	0366FL17	COURT COMPLEX	AMR	OK	31.03.2023	Category 4			15194793	Not installed	0.087	NA	Director/D	
B.10476	West	BATHINDA	11KV	DS DIVN. MANSA	DS S/D SURDULGARH	0366FL01	ALHUPUR	AMR	OK	31.03.2023	AP 3Phase 3Wire			10273761	Not installed	1.307	NA	Director/D	
B.10477	West	BATHINDA	11KV	DS DIVN. MANSA	DS S/D SURDULGARH	0366FL15	ROHIMBARHA	AMR	OK	31.03.2023	AP 3Phase 3Wire			8223347	Not installed	1.859	NA	Director/D	
B.10478	West	BATHINDA	11KV	DS DIVN. MANSA	DS S/D SURDULGARH	0366FL04	FODS MANDI	AMR	OK	31.03.2023	AP 3Phase 3Wire			8223357	Not installed	2.149	NA	Director/D	
B.10479	West	BATHINDA	11KV	DS DIVN. MANSA	DS S/D SURDULGARH	0366FL08	KHERA	AMR	OK	31.03.2023	AP 3Phase 3Wire			8222390	Not installed	2.335	NA	Director/D	
B.10480	West	BATHINDA	11KV	DS DIVN. MANSA	DS S/D SURDULGARH	0366FL05	SARDULEWALA	AMR	OK	31.03.2023	AP 3Phase 3Wire			10273780	Not installed	2.457	NA	Director/D	
B.10481	West	BATHINDA	11KV	DS DIVN. MANSA	DS S/D SURDULGARH	0366FL16	mehre ap	AMR	OK	31.03.2023	AP 3Phase 3Wire			8222390	Not installed	2.643	NA	Director/D	
B.10482	West	BATHINDA	11KV	DS DIVN. MANSA	DS S/D SURDULGARH	0366FL09	BHUNDER	NON AMR	OK	31.03.2023	AP 3Phase 3Wire			2067149	Not installed	2.765	NA	Director/D	
B.10483	West	BATHINDA	11KV	DS DIVN. MANSA	DS S/D SURDULGARH	0366FL07	BHAGWAN PURA	AMR	OK	31.03.2023	AP 3Phase 3Wire			10273767	Not installed	2.831	NA	Director/D	
B.10484	West	BATHINDA	11KV	DS DIVN. MANSA	DS S/D SURDULGARH	0366FL10	BABA VALITE SHAH	AMR	OK	31.03.2023	AP 3Phase 3Wire			10273770	Not installed	2.877	NA	Director/D	
B.10485	West	BATHINDA	11KV	DS DIVN. MANSA	DS S/D SURDULGARH	0366FL10	MIRPUR	AMR	OK	31.03.2023	Category 5-U/PS			5342170	Not installed	3.498	NA	Director/D	
B.10486	West	BATHINDA	11KV	DS DIVN. MANSA	DS S/D SURDULGARH	0366FL19	INDUSTRIAL	AMR	OK	31.03.2023	Category 1			3297	Not installed	4.204	NA	Director/D	
B.10487	West	BATHINDA	11KV	DS DIVN. MANSA	DS S/D SURDULGARH	0366FL18	BABA BAHU DASS JI	NON AMR	OK	31.03.2023	Category 1			3283	Not installed	5.002	NA	Director/D	
B.10488	West	BATHINDA	11KV	DS DIVN. MANSA	DS S/D SURDULGARH	0366FL14	SARDULGARH MANCHAN	AMR	OK	31.03.2023	Category 1			23201	Not installed	7.798	NA	Director/D	
B.10489	West	BATHINDA	11KV	DS DIVN. MANSA	DS S/D SURDULGARH	0366FL03	SARDULGARH	NON AMR	OK	31.03.2023	Category 1			5390808	Not installed	7.874	NA	Director/D	
B.10490	West	BATHINDA	11KV	DS DIVN. MANSA	DS S/D SURDULGARH	0366FL11	HJANDA KHURD	AMR	OK	31.03.2023	Category 5-U/PS			5437498	Not installed	10.676	NA	Director/D	
B.10491	West	BATHINDA	11KV	DS DIVN. MANSA	DS S/D SURDULGARH	0366FL06	KUSLA	AMR	OK	31.03.2023	Category 5-U/PS			11069741	Not installed	10.980	NA	Director/D	
B.10492	West	BATHINDA	11KV	DS DIVN. MANSA	DS S/D S/D MANSA	835FL14	PUDA COLONY	AMR	OK	31.03.2023	Category 4			497999	Not installed	0.003	NA	Director/D	
B.10493	West	BATHINDA	11KV	DS DIVN. MANSA	DS S/D S/D MANSA	835FL08	PL ROAD	AMR	OK	31.03.2023	Category 5-U/PS			955144	Not installed	0.245	NA	Director/D	
B.10494	West	BATHINDA	11KV	DS DIVN. MANSA	DS S/D S/D MANSA	835FL11	DISTT JAIL	AMR	OK	31.03.2023	Category 4			33381	1200-600/5	6.410	NA	Director/D	
B.10495	West	BATHINDA	11KV	DS DIVN. MANSA	DS S/D S/D MANSA	835FL03	BHANI BAGA	AMR	OK	31.03.2023	AP 3Phase 3Wire			2067956	1200-600/5	2.365	NA	Director/D	
B.10496	West	BATHINDA	11KV	DS DIVN. MANSA	DS S/D S/D MANSA	835FL12	Rohi Wala	AMR	OK	31.03.2023	AP 3Phase 3Wire			33393	Not installed	2.756	NA	Director/D	
B.10497	West	BATHINDA	11KV	DS DIVN. MANSA	DS S/D S/D MANSA	835FL09	THUTHANWALI	AMR	OK	31.03.2023	AP 3Phase 3Wire			2066692	1200-600/5	2.798	NA	Director/D	
B.10498	West	BATHINDA	11KV	DS DIVN. MANSA	DS S/D S/D MANSA	835FL04	KHALIA	AMR	OK	31.03.2023	AP 3Phase 3Wire			8222974	Not installed	3.137	NA	Director/D	
B.10499	West	BATHINDA	11KV	DS DIVN. MANSA	DS S/D S/D MANSA	835FL10	KANSA KHURD	AMR	OK	31.03.2023	AP 3Phase 3Wire			2027149	1200-600/5	3.668	NA	Director/D	
B.10500	West	BATHINDA	11KV	DS DIVN. MANSA	DS S/D S/D MANSA	835FL05	KHALIA UPS	AMR	OK	31.03.2023	Category 5-U/PS			2067861	Not installed	7.473	NA	Director/D	
B.10501	West	BATHINDA	11KV	DS DIVN. MANSA	DS S/D S/D MANSA	835FL02	KANCHIAN	NON AMR	OK	31.03.2023	Category 1			2067968	Not installed	9.282	NA	Director/D	
B.10502	West	BATHINDA	11KV	DS DIVN. MANSA	DS S/D S/D MANSA	835FL08	KHOKHAR UPS	AMR	OK	31.03.2023	Category 5-U/PS			9154123	Not installed	16.942	NA	Director/D	
B.10503	West	BATHINDA	11KV	DS DIVN. MANSA	DS S/D S/D MANSA	X37FL05	Gaowal AP	AMR	OK	31.03.2023	AP 3Phase 3Wire			2046479	Not installed	2.102	NA	Director/D	
B.10504	West	BATHINDA	11KV	DS DIVN. MANSA	DS S/D S/D MANSA	0366FL09	KHOKHAR	AMR	OK	31.03.2023	AP 3Phase 3Wire			2047142	Not installed	2.206	NA	Director/D	
B.10505	West	BATHINDA	11KV	DS DIVN. MANSA	DS S/D S/D MANSA	0366FL12	DULO WAL	AMR	OK	31.03.2023	AP 3Phase 3Wire			4280	900-450/577/1-1-1	2.183	NA	Director/D	
B.10506	West	BATHINDA	11KV	DS DIVN. MANSA	DS S/D S/D MANSA	0366FL05	BAJEWALA	NON AMR	OK	31.03.2023	Category 5-U/PS			8823346	900-450/577/1-1-1	1			

S.No	Zone	Circle	Voltage Level (kVA)	Division (kVA)	Sub-Division (kVA)	Feeder ID	Feeder Name	Feeder Metering Status (Metered/unmetered/AMR/AMI)	Status of Meter (Functional/Non-Functional)	Metering Date (Date of last actual meter reading/communication)	Feeder Type (Agr/Industrial/Mixed)	Status of Communication			Period from 01.04.2021 to 31.03.2022				Sales	Remarks (Source of data)
												% data received through automatically if feeder AMR/AMI	Number of hours when meter was unable to communicate in overall	Total Number of hours in the period	Meter S.No	CT/PT ratio	Import (kWh)	Export (kWh)		
B.10543	West	BATHINDA	11kV	DS DIVN. MAUR	DS CITY S/D MAUR	0385FL13	BHAGAT AP	AMR	OK	31.03.2023	AP 3Phase 3Wire				3153	900-450/577/1-1-1	1.319	NA	Director/D	
B.10544	West	BATHINDA	11kV	DS DIVN. MAUR	DS CITY S/D MAUR	0385SL12	bangana	AMR	OK	31.03.2023	AP 3Phase 3Wire				3156	900-450/577/1-1-1	1.936	NA	Director/D	
B.10545	West	BATHINDA	11kV	DS DIVN. MAUR	DS CITY S/D MAUR	0385FL05	MAURI	AMR	OK	31.03.2023	AP 3Phase 3Wire				822830	900-450/577/1-1-1	2.230	NA	Director/D	
B.10546	West	BATHINDA	11kV	DS DIVN. MAUR	DS CITY S/D MAUR	0385FL09	Baba Nanak	AMR	OK	31.03.2023	AP 3Phase 3Wire				11544657	900-450/577/1-1-1	2.851	NA	Director/D	
B.10547	West	BATHINDA	11kV	DS DIVN. MAUR	DS CITY S/D MAUR	0385FL08	Bhai Bakthor	AMR	OK	31.03.2023	AP 3Phase 3Wire				10282925	Not installed	3.318	NA	Director/D	
B.10548	West	BATHINDA	11kV	DS DIVN. MAUR	DS CITY S/D MAUR	0385FL00	YATRI	AMR	OK	31.03.2023	AP 3Phase 3Wire				10288404	Not installed	3.490	NA	Director/D	
B.10549	West	BATHINDA	11kV	DS DIVN. MAUR	DS CITY S/D MAUR	0385FL04	NATT	AMR	OK	31.03.2023	AP 3Phase 3Wire				8222829	Not installed	3.715	NA	Director/D	
B.10550	West	BATHINDA	11kV	DS DIVN. MAUR	DS CITY S/D MAUR	0385FL02	JODHPUR URBAN	AMR	OK	31.03.2023	Category 1				6489146	900-450/577/1-1-1	4.862	NA	Director/D	
B.10551	West	BATHINDA	11kV	DS DIVN. MAUR	DS CITY S/D MAUR	0385FL01	MANGA KALAN	AMR	OK	31.03.2023	Category 5-UUPS				6485583	Not installed	5.165	NA	Director/D	
B.10552	West	BATHINDA	11kV	DS DIVN. MAUR	DS CITY S/D MAUR	0385FL07	BURI SEMA	AMR	OK	31.03.2023	Category 5-UUPS				8222826	900-450/577/1-1-1	9.970	NA	Director/D	
B.10553	West	BATHINDA	11kV	DS DIVN. MAUR	DS CITY S/D MAUR	0363FL10	LAMMI	AMR	OK	31.03.2023	AP 3Phase 3Wire				3142	1200/577/1-1-1	1.236	NA	Director/D	
B.10554	West	BATHINDA	11kV	DS DIVN. MAUR	DS CITY S/D MAUR	0367FL11	SEKHPURA AP	NON AMR	OK	31.03.2023	AP 3Phase 3Wire				4634	1200/577/1-1-1	1.869	NA	Director/D	
B.10555	West	BATHINDA	11kV	DS DIVN. MAUR	DS CITY S/D MAUR	KSF101	Sandoha	AMR	OK	31.03.2023	AP 3Phase 3Wire				34119	1200/577/1-1-1	2.168	NA	Director/D	
B.10556	West	BATHINDA	11kV	DS DIVN. MAUR	DS CITY S/D MAUR	KSF106	KUBBEY	NON AMR	OK	31.03.2023	AP 3Phase 3Wire				34441	1200/577/1-1-1	2.180	NA	Director/D	
B.10557	West	BATHINDA	11kV	DS DIVN. MAUR	DS CITY S/D MAUR	KSF105	Komali	NON AMR	OK	31.03.2023	AP 3Phase 3Wire				34122	1200/577/1-1-1	2.592	NA	Director/D	
B.10558	West	BATHINDA	11kV	DS DIVN. MAUR	DS CITY S/D MAUR	KSF104	Swetch	NON AMR	OK	31.03.2023	Category 1				34245	1200/577/1-1-1	2.657	NA	Director/D	
B.10559	West	BATHINDA	11kV	DS DIVN. MAUR	DS CITY S/D MAUR	KSF102	guru kashi	AMR	OK	31.03.2023	AP 3Phase 3Wire				34118	1200/577/1-1-1	2.852	NA	Director/D	
B.10560	West	BATHINDA	11kV	DS DIVN. MAUR	DS CITY S/D MAUR	KSF105	DALYE WALI	AMR	OK	31.03.2023	Category 5-UUPS				36963	1200/577/1-1-1	4.962	NA	Director/D	
B.10561	West	BATHINDA	11kV	DS DIVN. MAUR	DS CITY S/D MAUR	X367FL12	Buri UPS	AMR	OK	31.03.2023	Category 5-UUPS				4424	1200/577/1-1-1	5.547	NA	Director/D	
B.10562	West	BATHINDA	11kV	DS DIVN. MAUR	DS CITY S/D MAUR	X366FL03	SADA SINGH WALA	AMR	OK	31.03.2023	Category 5-UUPS				9154445	Not installed	6.977	NA	Director/D	
B.10563	West	BATHINDA	11kV	DS DIVN. MAUR	DS CITY S/D MAUR	X366FL11	BOHAR	AMR	OK	31.03.2023	AP 3Phase 3Wire				4702	Not installed	9.528	NA	Director/D	
B.10564	West	BATHINDA	11kV	DS DIVN. MAUR	DS CITY S/D MAUR	X366FL11	kalloh	AMR	OK	31.03.2023	AP 3Phase 3Wire				2904	Not installed	2.270	NA	Director/D	
B.10565	West	BATHINDA	11kV	DS DIVN. MAUR	DS CITY S/D MAUR	X366FL02	KOTLI KHURD	AMR	OK	31.03.2023	AP 3Phase 3Wire				9154395	Not installed	2.336	NA	Director/D	
B.10566	West	BATHINDA	11kV	DS DIVN. MAUR	DS CITY S/D MAUR	X366FL01	KOTLI KALAN	AMR	OK	31.03.2023	Category 1				9154405	Not installed	2.855	NA	Director/D	
B.10567	West	BATHINDA	11kV	DS DIVN. MAUR	DS CITY S/D MAUR	X366FL04	TARHA SAHB	AMR	OK	31.03.2023	Category 5-UUPS				9154367	Not installed	4.740	NA	Director/D	
B.10568	West	BATHINDA	11kV	DS DIVN. MAUR	DS CITY S/D MAUR	0366FL10	MAUR KHURD	AMR	OK	31.03.2023	Category 5-UUPS				1116873	Not installed	6.866	NA	Director/D	
B.10569	West	BATHINDA	11kV	DS DIVN. MAUR	DS CITY S/D MAUR	X373FL10	Water Works (from 66KV Maur)	AMR	OK	31.03.2023	Category 1				16199431	1200/577/1-1-1	8.576	NA	Director/D	
B.10570	West	BATHINDA	11kV	DS DIVN. MAUR	DS CITY S/D MAUR	X373FL09	PUMP ROAD (From 66KV Maur)	NON AMR	OK	31.03.2023	Category 1				16199320	1200/577/1-1-1	8.878	NA	Director/D	
B.10571	West	BATHINDA	11kV	DS DIVN. MAUR	DS CITY S/D MAUR	X373FL08	Partap Sintex (66KV MAUR)	AMR	OK	31.03.2023	Category 4				16199284	1200/577/1-1-1	10.322	NA	Director/D	
B.10572	West	BATHINDA	11kV	DS DIVN. MAUR	DS CITY S/D MAUR	0366FL07	TALWANDI AKLIA	AMR	OK	31.03.2023	AP 3Phase 3Wire				8223608	Not installed	1.851	NA	Director/D	
B.10573	West	BATHINDA	11kV	DS DIVN. MAUR	DS S/D KOT SHAMIR	C352FL10	Sudhant City	AMR	OK	31.03.2023	Category 1				24915	Not installed	1.430	NA	Director/D	
B.10574	West	BATHINDA	11kV	DS DIVN. MAUR	DS S/D KOT SHAMIR	C352FL04	PHOOSI MANDI	NON AMR	OK	31.03.2023	AP 3Phase 3Wire				1116789	Not installed	1.603	NA	Director/D	
B.10575	West	BATHINDA	11kV	DS DIVN. MAUR	DS S/D KOT SHAMIR	C352FL12	Ohga AP	AMR	OK	31.03.2023	AP 3Phase 3Wire				5424	Not installed	3.333	NA	Director/D	
B.10576	West	BATHINDA	11kV	DS DIVN. MAUR	DS S/D KOT SHAMIR	C380FL11	IOCL	AMR	OK	31.03.2023	Category 4				12527350	Not installed	3.438	NA	Director/D	
B.10577	West	BATHINDA	11kV	DS DIVN. MAUR	DS S/D KOT SHAMIR	C352FL06	DEPTU	AMR	OK	31.03.2023	Category 5-UUPS				1116867	Not installed	3.561	NA	Director/D	
B.10578	West	BATHINDA	11kV	DS DIVN. MAUR	DS S/D KOT SHAMIR	C352FL09	GEHRI BHAGI	AMR	OK	31.03.2023	AP 3Phase 3Wire				13190512	Not installed	3.866	NA	Director/D	
B.10579	West	BATHINDA	11kV	DS DIVN. MAUR	DS S/D KOT SHAMIR	C352FL01	JASSI	AMR	OK	31.03.2023	AP 3Phase 3Wire				1029366	Not installed	4.067	NA	Director/D	
B.10580	West	BATHINDA	11kV	DS DIVN. MAUR	DS S/D KOT SHAMIR	C352FL05	GILLAB GARH	AMR	OK	31.03.2023	Category 5-UUPS				1116967	Not installed	10.387	NA	Director/D	
B.10581	West	BATHINDA	11kV	DS DIVN. MAUR	DS S/D KOT SHAMIR	New3FL08	Nasibura	AMR	OK	31.03.2023	AP 3Phase 3Wire				2066817	Not installed	3.001	NA	Director/D	
B.10582	West	BATHINDA	11kV	DS DIVN. MAUR	DS S/D KOT SHAMIR	X356FL08	DERA VASAU DASS	AMR	OK	31.03.2023	AP 3Phase 3Wire				13190555	Not installed	2.740	NA	Director/D	
B.10583	West	BATHINDA	11kV	DS DIVN. MAUR	DS S/D KOT SHAMIR	New1New1	Butar Pati	AMR	OK	31.03.2023	AP 3Phase 3Wire				10282930	Not installed	2.925	NA	Director/D	
B.10584	West	BATHINDA	11kV	DS DIVN. MAUR	DS S/D KOT SHAMIR	DHANFL09	YATRI PATTI	NON AMR	OK	31.03.2023	AP 3Phase 3Wire				13190480	Not installed	3.712	NA	Director/D	
B.10585	West	BATHINDA	11kV	DS DIVN. MAUR	DS S/D KOT SHAMIR	X356FL12	Petro Pump	AMR	OK	31.03.2023	AP 3Phase 3Wire				199058	Not installed	4.043	NA	Director/D	
B.10586	West	BATHINDA	11kV	DS DIVN. MAUR	DS S/D KOT SHAMIR	DHANFL08	KOT FATTA	AMR	OK	31.03.2023	Category 1				10288400	Not installed	5.910	NA	Director/D	
B.10587	West	BATHINDA	11kV	DS DIVN. MAUR	DS S/D KOT SHAMIR	X356FL06	UPS Tungvali	AMR	OK	31.03.2023	Category 5-UUPS				12093466	Not installed	7.455	NA	Director/D	
B.10588	West	BATHINDA	11kV	DS DIVN. MAUR	DS S/D KOT SHAMIR	X363FL04	Rangan Bhunder	AMR	OK	31.03.2023	AP 3Phase 3Wire				12527343	Not installed	3.401	NA	Director/D	
B.10589	West	BATHINDA	11kV	DS DIVN. MAUR	DS S/D KOT SHAMIR	X363FL05	Drain Area	AMR	OK	31.03.2023	Category 5-UUPS				12527382	Not installed	5.701	NA	Director/D	
B.10590	West	BATHINDA	11kV	DS DIVN. MAUR	DS S/D KOT SHAMIR	DTM6FL06	Chakr-wala AP	AMR	OK	31.03.2023	AP 3Phase 3Wire				5645	Not installed	6.028	NA	Director/D	
B.10591	West	BATHINDA	11kV	DS DIVN. MAUR	DS S/D KOT SHAMIR	DTM6FL05	Damdama Sahib AP	AMR	OK	31.03.2023	AP 3Phase 3Wire				5645	Not installed	6.845	NA	Director/D	
B.10592	West	BATHINDA	11kV	DS DIVN. MAUR	DS S/D KOT SHAMIR	DTM6FL03	Jwan Singh wala CAT-1	AMR	OK	31.03.2023	Category 1				5592	Not installed	3.290	NA	Director/D	
B.10593	West	BATHINDA	11kV	DS DIVN. MAUR	DS S/D KOT SHAMIR	DTM6FL04	Bhagwinder UPS	AMR	OK	31.03.2023	Category 5-UUPS				5646	Not installed	12.517	NA	Director/D	
B.10594	West	BATHINDA	11kV	DS DIVN. MAUR	DS S/D KOT SHAMIR	0373FL08	BHAGU	AMR	OK	31.03.2023	Category 5-UUPS				5388156	Not installed	0.576	NA	Director/D	
B.10595	West	BATHINDA	11kV	DS DIVN. MAUR	DS S/D KOT SHAMIR	0373FL10	ANSAL MITTAL	AMR	OK	31.03.2023	Category 1				8223515	Not installed	1.129	NA	Director/D	
B.10596	West	BATHINDA	11kV	DS DIVN. MAUR	DS S/D KOT SHAMIR	0373FL10	BHAGI VANDER	AMR	OK	31.03.2023	Category 5-UUPS				7043393	Not installed	1.202	NA	Director/D	
B.10597	West	BATHINDA	11kV	DS DIVN. MAUR	DS S/D KOT SHAMIR	0373FL11	BATHINDA ROAD	AMR	OK	31.03.2023	Category 5-UUPS				10281321	Not installed	1.790	NA	Director/D	
B.10598	West	BATHINDA	11kV	DS DIVN. MAUR	DS S/D KOT SHAMIR	0373FL06	TILLA	AMR	OK	31.03.2023	AP 3Phase 3Wire				8223198	Not installed	1.956	NA	Director/D	
B.10599	West	BATHINDA	11kV	DS DIVN. MAUR	DS S/D KOT SHAMIR	0373FL12	JIWAN SINGH WALA	NON AMR	OK	31.03.2023	AP 3Phase 3Wire				2809	Not installed	2.270	NA	Director/D	
B.10600	West	BATHINDA	11kV	DS DIVN. MAUR	DS S/D KOT SHAMIR	0373FL13	TALWANDI ROAD AP	AMR	OK	31.03.2023	AP 3Phase 3Wire				16199564	Not installed	2.838	NA	Director/D	
B.10601	West	BATHINDA	11kV	DS DIVN. MAUR	DS S/D KOT SHAMIR	0373FL10	Mansa Road	AMR	OK	31.03.2023	Category 5-UUPS				914095	Not installed	3.062	NA	Director/D	
B.10602	West	BATHINDA	11kV	DS DIVN. MAUR	DS S/D KOT SHAMIR	0373FL02	KOT SHAMIR	AMR	OK	31.03.2023	AP 3Phase 3Wire				914095	Not installed	3.062	NA	Director/D	
B.10603	West	BATHINDA	11kV	DS DIVN. MAUR	DS S/D KOT SHAMIR	0373FL01	TUNGWALI	NON AMR	OK	31.03.2023	AP 3Phase 3Wire				914094	Not installed	3.109	NA	Director/D	
B.10604	West	BATHINDA	11kV	DS DIVN. MAUR	DS S/D KOT SHAMIR	0373FL14	DERA BABA MURLIDHAR AP	AMR	OK	31.03.2023	AP 3Phase 3Wire				16199277	Not installed	3.504	NA	Director/D	
B.10605	West	BATHINDA	11kV	DS DIVN. MAUR	DS S/D KOT SHAMIR	0373FL21	Kalewander	AMR	OK	31.03.2023	Category 5-UUPS				2778	Not installed	3.549	NA	Director/D	
B.10606	West	BATHINDA	11kV	DS DIVN. MAUR	DS S/D KOT SHAMIR	0373FL04	KOT BHARA	AMR	OK	31.03.2023	AP 3Phase 3Wire				9154009	Not installed	3.626	NA	Director/D	
B.10607	West	BATHINDA	11kV	DS DIVN. MAUR	DS S/D KOT SHAMIR	0373FL03	CT FEEDER	AMR	OK	31.03.2023	Category 5-UUPS				7335504	Not installed	7.842	NA	Director/D	
B.10608	West	BATHINDA	11kV	DS DIVN. MAUR	DS S/D KOT SHAMIR	0373FL09	AZAD	Not available	OK	31.03.2023	Category 4				7336557	Not installed	12.013	NA	Director/D	
B.10609	West	BATHINDA	132kV	DS DIVN. MAUR	DS S/D KOT SHAMIR	C352B7	Railway Traction Gehri Bhagi	Not available	OK	31.03.2023	Category 4				Not available	Not available	8.321	NA	Director/D	
B.10610	West	BATHINDA	66kV	DS DIVN. MAUR	DS S/D KOT SHAMIR															

S.No	Zone	Circle	Voltage (kV)	Division (kVA)	Sub-Division (kVA)	Feeder ID	Feeder Name	Feeder Metering Status (Metered/unmetered/AMR/AMI)	Status of Meter (Functional/Non-Functional)	Metering Date (Date of last actual meter reading/communication)	Feeder Type (Agr/Industrial/Mixed)	Status of Communication		Period from 01.04.2021 to 31.03.2022				Sales	Remarks (Source of data)
												% Data received through automatically if feeder AMR/AMI	Number of hours when meter was unable to communicate in overall	Total Number of hours in the period	Meter S.No	CT/PT ratio	Import (kU)		
B.10640	West	BATHINDA	11KV	DS DIVN. MAUR	DS S/D RAMA MANDI	X383F04	Tarkhanwala AP	NON AMR	OK	31.03.2023	AP 3Phase 3Wire			12479724	900-450/577/1-1-1	2.734	NA	Director/D	
B.10641	West	BATHINDA	11KV	DS DIVN. MAUR	DS S/D RAMA MANDI	X383F02	Sukhladi	NON AMR	OK	31.03.2023	Category 5-UPS			16199575	900-450/577/1-1-1	4.398	NA	Director/D	
B.10642	West	BATHINDA	11KV	DS DIVN. MAUR	DS S/D RAMA MANDI	X383F01	Senu	AMR	OK	31.03.2023	Category 5-UPS			16199504	900-450/577/1-1-1	4.962	NA	Director/D	
B.10643	West	BATHINDA	11KV	DS DIVN. MAUR	DS S/D TALWANDI SAHBO	X366F03	FATHEGARH	AMR	OK	31.03.2023	AP 3Phase 3Wire			2953725	1200/577/1-1-1	1.243	NA	Director/D	
B.10644	West	BATHINDA	11KV	DS DIVN. MAUR	DS S/D TALWANDI SAHBO	X366F06	GURUSAR	AMR	OK	31.03.2023	Category 5-UPS			1988865	1200/577/1-1-1	1.260	NA	Director/D	
B.10645	West	BATHINDA	11KV	DS DIVN. MAUR	DS S/D TALWANDI SAHBO	X366F10	HOSPITAL	AMR	OK	31.03.2023	Category 4			10273810	900-450/577/1-1-1	1.795	NA	Director/D	
B.10646	West	BATHINDA	11KV	DS DIVN. MAUR	DS S/D TALWANDI SAHBO	X366F11	KIRTANPURA SAHIB	AMR	OK	31.03.2023	AP 3Phase 3Wire			2067181	900-450/577/1-1-1	1.909	NA	Director/D	
B.10647	West	BATHINDA	11KV	DS DIVN. MAUR	DS S/D TALWANDI SAHBO	X366F16	NAWAN PIND DHANI	AMR	OK	31.03.2023	AP 3Phase 3Wire			3139	900-450/577/1-1-1	2.258	NA	Director/D	
B.10648	West	BATHINDA	11KV	DS DIVN. MAUR	DS S/D TALWANDI SAHBO	X366F14	SANGAT	AMR	OK	31.03.2023	AP 3Phase 3Wire			3139	900-450/577/1-1-1	2.535	NA	Director/D	
B.10649	West	BATHINDA	11KV	DS DIVN. MAUR	DS S/D TALWANDI SAHBO	X366F13	Behman	AMR	OK	31.03.2023	AP 3Phase 3Wire			33611	1200/577/1-1-1	2.595	NA	Director/D	
B.10650	West	BATHINDA	11KV	DS DIVN. MAUR	DS S/D TALWANDI SAHBO	X366F01	SHEKH-PURA	AMR	OK	31.03.2023	AP 3Phase 3Wire			2067579	1200/577/1-1-1	2.856	NA	Director/D	
B.10651	West	BATHINDA	11KV	DS DIVN. MAUR	DS S/D TALWANDI SAHBO	X366F03	GATWALI	AMR	OK	31.03.2023	AP 3Phase 3Wire			2067355	1200/577/1-1-1	2.992	NA	Director/D	
B.10652	West	BATHINDA	11KV	DS DIVN. MAUR	DS S/D TALWANDI SAHBO	X366F10	Talwandi Sabo	AMR	OK	31.03.2023	AP 3Phase 3Wire			9568304	900-450/577/1-1-1	3.243	NA	Director/D	
B.10653	West	BATHINDA	11KV	DS DIVN. MAUR	DS S/D TALWANDI SAHBO	X366F18	MAUR ROAD	AMR	OK	31.03.2023	Category 1			3292	1200/577/1-1-1	4.609	NA	Director/D	
B.10654	West	BATHINDA	11KV	DS DIVN. MAUR	DS S/D TALWANDI SAHBO	X366F04	HALKANA	AMR	OK	31.03.2023	Category 5-UPS			2067058	900-450/577/1-1-1	4.690	NA	Director/D	
B.10655	West	BATHINDA	11KV	DS DIVN. MAUR	DS S/D TALWANDI SAHBO	X366F17	TEONA PUIARIAN	AMR	OK	31.03.2023	Category 5-UPS			3178	1200/577/1-1-1	5.362	NA	Director/D	
B.10656	West	BATHINDA	11KV	DS DIVN. MAUR	DS S/D TALWANDI SAHBO	X366F12	LELEWALA	AMR	OK	31.03.2023	Category 5-UPS			2067058	900-450/577/1-1-1	8.716	NA	Director/D	
B.10657	West	BATHINDA	11KV	DS DIVN. MAUR	DS S/D TALWANDI SAHBO	X366F07	RORI ROAD	AMR	OK	31.03.2023	Category 1			5388136	900-450/577/1-1-1	12.457	NA	Director/D	
B.10658	West	BATHINDA	11KV	DS DIVN. MAUR	DS S/D TALWANDI SAHBO	X366F08	RAMAN ROAD	NON AMR	OK	31.03.2023	Category 1			6740483	1200/577/1-1-1	12.579	NA	Director/D	
B.10659	West	BATHINDA	11KV	DS DIVN. MAUR	DS S/D TALWANDI SAHBO	X366F03	Dhuri Banawali	AMR	OK	31.03.2023	Category 4			20244	1200/577/1-1-1	0.969	NA	Director/D	
B.10660	West	BATHINDA	11KV	DS DIVN. MAUR	DS S/D TALWANDI SAHBO	X362F08	NEW MALWA	AMR	OK	31.03.2023	AP 3Phase 3Wire			3331	Not installed	0.965	NA	Director/D	
B.10661	West	BATHINDA	11KV	DS DIVN. MAUR	DS S/D TALWANDI SAHBO	X362F07	DHINGAR	AMR	OK	31.03.2023	AP 3Phase 3Wire			3337	Not installed	1.726	NA	Director/D	
B.10662	West	BATHINDA	11KV	DS DIVN. MAUR	DS S/D TALWANDI SAHBO	X362F02	BHAGWANPURA	AMR	OK	31.03.2023	AP 3Phase 3Wire			12527286	Not installed	2.050	NA	Director/D	
B.10663	West	BATHINDA	11KV	DS DIVN. MAUR	DS S/D TALWANDI SAHBO	X362F04	JAMBER BASTI	AMR	OK	31.03.2023	AP 3Phase 3Wire			9154345	Not installed	2.354	NA	Director/D	
B.10664	West	BATHINDA	11KV	DS DIVN. MAUR	DS S/D TALWANDI SAHBO	X362F03	SINGO	AMR	OK	31.03.2023	AP 3Phase 3Wire			9154480	Not installed	2.658	NA	Director/D	
B.10665	West	BATHINDA	11KV	DS DIVN. MAUR	DS S/D TALWANDI SAHBO	X362F01	JAGGA RAM TIRTH	NON AMR	OK	31.03.2023	Category 1			9154329	Not installed	3.207	NA	Director/D	
B.10666	West	BATHINDA	11KV	DS DIVN. MAUR	DS S/D TALWANDI SAHBO	X362F06	NEW PUNJAB POLYTECHNIC COLLEGE	AMR	OK	31.03.2023	Category 5-UPS			12527377	Not installed	5.385	NA	Director/D	
B.10667	West	BATHINDA	11KV	DS DIVN. MAUR	DS S/D TALWANDI SAHBO	X362New	Manuana	AMR	OK	31.03.2023	Category 5-UPS			9154298	Not installed	7.006	NA	Director/D	
B.10668	West	BATHINDA	11KV	DS DIVN. MAUR	DS S/D TALWANDI SAHBO	X367F09	Banawala	AMR	OK	31.03.2023	AP 3Phase 3Wire			15193766	1200/577/1-1-1	2.889	NA	Director/D	
B.10669	West	BATHINDA	11KV	DS DIVN. MAUR	DS S/D TALWANDI SAHBO	X367F08	Chehawa	AMR	OK	31.03.2023	Category 5-UPS			15193758	1200/577/1-1-1	5.706	NA	Director/D	
B.10670	West	BATHINDA	11KV	DS DIVN. MAUR	DS S/D TALWANDI SAHBO	X377F04	PERON	NON AMR	OK	31.03.2023	AP 3Phase 3Wire			5342141	Not installed	1.842	NA	Director/D	
B.10671	West	BATHINDA	11KV	DS DIVN. MAUR	DS S/D TALWANDI SAHBO	X377F07	Behniwal	AMR	OK	31.03.2023	AP 3Phase 3Wire			12527366	Not installed	2.140	NA	Director/D	
B.10672	West	BATHINDA	11KV	DS DIVN. MAUR	DS S/D TALWANDI SAHBO	X377F05	NAINGLA	AMR	OK	31.03.2023	Category 1			5342155	Not installed	2.355	NA	Director/D	
B.10673	West	BATHINDA	11KV	DS DIVN. MAUR	DS S/D TALWANDI SAHBO	X377F02	NATHEHA	NON AMR	OK	31.03.2023	AP 3Phase 3Wire			2066610	Not installed	2.467	NA	Director/D	
B.10674	West	BATHINDA	11KV	DS DIVN. MAUR	DS S/D TALWANDI SAHBO	X377F08	Fattabahu	AMR	OK	31.03.2023	AP 3Phase 3Wire			23547	Not installed	2.604	NA	Director/D	
B.10675	West	BATHINDA	11KV	DS DIVN. MAUR	DS S/D TALWANDI SAHBO	X377F06	Koreana	AMR	OK	31.03.2023	AP 3Phase 3Wire			12527366	Not installed	2.884	NA	Director/D	
B.10676	West	BATHINDA	11KV	DS DIVN. MAUR	DS S/D TALWANDI SAHBO	X377F03	LEHR	AMR	OK	31.03.2023	Category 5-UPS			5342170	Not installed	4.525	NA	Director/D	
B.10677	West	BATHINDA	11KV	DS DIVN. MAUR	DS S/D TALWANDI SAHBO	X377F01	GOLDWALA	AMR	OK	31.03.2023	Category 5-UPS			5342272	Not installed	8.299	NA	Director/D	
B.10678	West	BATHINDA	11KV	DS DIVN. MAUR	DS S/D TALWANDI SAHBO	X362F01	JIFT TANDIAN	AMR	OK	31.03.2023	Category 4			11117080	Not installed	0.929	NA	Director/D	
B.10679	West	BATHINDA	11KV	DS DIVN. MAUR	DS S/D TALWANDI SAHBO	X362F05	KALAWALA	AMR	OK	31.03.2023	Category 5-UPS			11117172	Not installed	3.606	NA	Director/D	
B.10680	West	BATHINDA	11KV	DS DIVN. MAUR	DS S/U S/D MAUR	B351F13	Bhai Bhaktu	AMR	OK	31.03.2023	AP 3Phase 3Wire			45121	1200-600/5	1.532	NA	Director/D	
B.10681	West	BATHINDA	11KV	DS DIVN. MAUR	DS S/U S/D MAUR	B351F01	Tamkot	AMR	OK	31.03.2023	AP 3Phase 3Wire			8222975	Not installed	2.119	NA	Director/D	
B.10682	West	BATHINDA	11KV	DS DIVN. MAUR	DS S/U S/D MAUR	B351F15	Kr Ralla Road AP	AMR	OK	31.03.2023	AP 3Phase 3Wire			4939	1200-600/5	2.209	NA	Director/D	
B.10683	West	BATHINDA	11KV	DS DIVN. MAUR	DS S/U S/D MAUR	B351F07	Tamkot	AMR	OK	31.03.2023	Category 5-UPS			6740758	Not installed	6.205	NA	Director/D	
B.10684	West	BATHINDA	11KV	DS DIVN. MAUR	DS S/U S/D MAUR	C351F12	Titarsar AP	AMR	OK	31.03.2023	AP 3Phase 3Wire			2047131	Not installed	2.254	NA	Director/D	
B.10685	West	BATHINDA	11KV	DS DIVN. MAUR	DS S/U S/D MAUR	C351F09	Maisar khana	AMR	OK	31.03.2023	AP 3Phase 3Wire			2046502	Not installed	2.264	NA	Director/D	
B.10686	West	BATHINDA	11KV	DS DIVN. MAUR	DS S/U S/D MAUR	C351F03	Ramnagar	AMR	OK	31.03.2023	AP 3Phase 3Wire			2047131	Not installed	2.598	NA	Director/D	
B.10687	West	BATHINDA	11KV	DS DIVN. MAUR	DS S/U S/D MAUR	C351F19	KUTWAL KALAN	AMR	OK	31.03.2023	AP 3Phase 3Wire			9568323	Not installed	3.368	NA	Director/D	
B.10688	West	BATHINDA	11KV	DS DIVN. MAUR	DS S/U S/D MAUR	C351F05	Bhaini Chaur	AMR	OK	31.03.2023	AP 3Phase 3Wire			9141140	Not installed	3.365	NA	Director/D	
B.10689	West	BATHINDA	11KV	DS DIVN. MAUR	DS S/U S/D MAUR	C351F04	Sewak	AMR	OK	31.03.2023	AP 3Phase 3Wire			9568310	Not installed	3.950	NA	Director/D	
B.10690	West	BATHINDA	11KV	DS DIVN. MAUR	DS S/U S/D MAUR	C351F13	Balianwal	AMR	OK	31.03.2023	AP 3Phase 3Wire			6761890	Not installed	4.190	NA	Director/D	
B.10691	West	BATHINDA	11KV	DS DIVN. MAUR	DS S/U S/D MAUR	C351F11	Chanarhal	AMR	OK	31.03.2023	Category 5-UPS			5341637	Not installed	8.812	NA	Director/D	
B.10692	West	BATHINDA	11KV	DS DIVN. MAUR	DS S/U S/D MAUR	C351F12	Mandi Khurd	NON AMR	OK	31.03.2023	Category 5-UPS			9042963	Not installed	10.674	NA	Director/D	
B.10693	West	BATHINDA	11KV	DS DIVN. MAUR	DS S/U S/D MAUR	X362F04	220 RAILWAY CIRCUIT	AMR	OK	31.03.2023	Category 1			3206	Not installed	0.000	NA	Director/D	
B.10694	West	BATHINDA	11KV	DS DIVN. MAUR	DS S/U S/D MAUR	X368F19	Nandgarh Kotra	AMR	OK	31.03.2023	AP 3Phase 3Wire			7042045	Not installed	3.424	NA	Director/D	
B.10695	West	BATHINDA	11KV	DS DIVN. MAUR	DS S/U S/D MAUR	X361F16	Buri Jhabbar	AMR	OK	31.03.2023	AP 3Phase 3Wire			9153549	900-450/577/1-1-1	1.629	NA	Director/D	
B.10696	West	BATHINDA	11KV	DS DIVN. MAUR	DS S/U S/D MAUR	X361F15	Khark Singh Wala	NON AMR	OK	31.03.2023	Category 5-UPS			9153550	900-450/577/1-1-1	1.810	NA	Director/D	
B.10697	West	BATHINDA	11KV	DS DIVN. MAUR	DS S/U S/D MAUR	X361F13	SARITA PANJJI	AMR	OK	31.03.2023	AP 3Phase 3Wire			5437686	900-450/577/1-1-1	1.842	NA	Director/D	
B.10698	West	BATHINDA	11KV	DS DIVN. MAUR	DS S/U S/D MAUR	X361F19	Kr Baba Ramdass	AMR	OK	31.03.2023	AP 3Phase 3Wire			5437695	900-450/577/1-1-1	1.996	NA	Director/D	
B.10699	West	BATHINDA	11KV	DS DIVN. MAUR	DS S/U S/D MAUR	X361F02	Sardara	AMR	OK	31.03.2023	AP 3Phase 3Wire			12093456	900-450/577/1-1-1	3.375	NA	Director/D	
B.10700	West	BATHINDA	11KV	DS DIVN. MAUR	DS S/U S/D MAUR	X361F09	Peer	AMR	OK	31.03.2023	AP 3Phase 3Wire			12093497	900-450/577/1-1-1	2.408	NA	Director/D	
B.10701	West	BATHINDA	11KV	DS DIVN. MAUR	DS S/U S/D MAUR	X361F06	Buri Hari	AMR	OK	31.03.2023	AP 3Phase 3Wire			12093453	900-450/577/1-1-1	2.701	NA	Director/D	
B.10702	West	BATHINDA	11KV	DS DIVN. MAUR	DS S/U S/D MAUR	X361F14	Buri Dhillwan	NON AMR	OK	31.03.2023	Category 5-UPS			9135551	900-450/577/1-1-1	2.717	NA	Director/D	
B.10703	West	BATHINDA	11KV	DS DIVN. MAUR	DS S/U S/D MAUR	X361F12	Bhagwala	AMR	OK	31.03.2023	AP 3Phase 3Wire			23443	900-450/577/1-1-1	2.919	NA	Director/D	
B.10704	West	BATHINDA	11KV	DS DIVN. MAUR	DS S/U S/D MAUR	X361F07	Bhainiwal	AMR	OK	31.03.2023	AP 3Phase 3Wire			13800470	900-450/577/1-1-1	2.940	NA	Director/D	
B.10705	West	BATHINDA	11KV	DS DIVN. MAUR	DS S/U S/D MAUR	X361F18	Koche	AMR	OK	31.03.2023	AP 3Phase 3Wire			9153545	900-450/577/1-1-1	3.007	NA	Director/D	
B.10706	West	BATHINDA	11KV	DS DIVN. MAUR	DS S/U S/D MAUR	X361F17	Ujha	AMR	OK	31.03.2023	AP 3Phase 3Wire			9153576	900-450/577/1-1-1	3.074	NA	Director/D	
B.10707	West	BATHINDA	11																

S.No	Zone	Circle	Voltage Level (kVA)	Division (kVA)	Sub-Division (kVA)	Feeder ID	Feeder Name	Feeder Metering Status (Metered/unmetered/AM/AMR)	Status of Meter (Functional/Non-Functional)	Metering Date	Date of last actual meter reading/communication	Feeder Type (Agr/Industrial/Mixed)	Status of Communication			Period from 01.04.2021 to 31.03.2022				Sales	Remarks (Source of data)
													% data received through automatically if feeder AMR/AM	Number of hours when meter was unable to communicate in overall	Total Number of hours in the period	Meter S.No	CT/PT ratio	Import (kWh)	Export (kWh)		
B.10737	West	BATHINDA	11kV	DS DIVN. MAUR	DS S/U S/D MAUR	X373FL07	Ghunan Kalan	AMR	OK	31.03.2023		AP 3Phase 3Wire				1442	1200/577/1-1-1	2.802	NA	Director/D	
B.10738	West	BATHINDA	11kV	DS DIVN. MAUR	DS S/U S/D MAUR	X373FL11	KUTWAL KHURD	AMR	OK	31.03.2023		Category 5-U/PS				4841	1200/577/1-1-1	3.762	NA	Director/D	
B.10739	West	BATHINDA	11kV	DS DIVN. MAUR	DS S/U S/D MAUR	X373FL03	Bhai Desa	AMR	OK	31.03.2023		Category 5-U/PS				198015	1200/577/1-1-1	8.934	NA	Director/D	
B.10740	West	BATHINDA	11kV	DS DIVN. RAMPURA PHUL	DS S/D BHUCHO MANDI	O338FL09	Daulatnagar	NON AMR	OK	31.03.2023		AP 3Phase 3Wire				911044	Not installed	2.318	NA	Director/D	
B.10741	West	BATHINDA	11kV	DS DIVN. RAMPURA PHUL	DS S/D BHUCHO MANDI	O332FL14	Chil Hospital	AMR	OK	31.03.2023		Category 4				2066333	Not installed	0.059	NA	Director/D	
B.10742	West	BATHINDA	11kV	DS DIVN. RAMPURA PHUL	DS S/D BHUCHO MANDI	O332FL18	Dhan Guru Nanak	NON AMR	OK	31.03.2023		Category 1				9154343	Not installed	1.158	NA	Director/D	
B.10743	West	BATHINDA	11kV	DS DIVN. RAMPURA PHUL	DS S/D BHUCHO MANDI	O332FL09	11 kv Lavaresar AP	AMR	OK	31.03.2023		AP 3Phase 3Wire				4055	Not installed	1.450	NA	Director/D	
B.10744	West	BATHINDA	11kV	DS DIVN. RAMPURA PHUL	DS S/D BHUCHO MANDI	O332FL17	Korhe Thanda	AMR	OK	31.03.2023		AP 3Phase 3Wire				34194	Not installed	2.223	NA	Director/D	
B.10745	West	BATHINDA	11kV	DS DIVN. RAMPURA PHUL	DS S/D BHUCHO MANDI	O332FL05	BHAGU	AMR	OK	31.03.2023		AP 3Phase 3Wire				8223661	Not installed	2.404	NA	Director/D	
B.10746	West	BATHINDA	11kV	DS DIVN. RAMPURA PHUL	DS S/D BHUCHO MANDI	O332FL20	11 kv Baba Mallo AP	AMR	OK	31.03.2023		AP 3Phase 3Wire				2066333	Not installed	2.415	NA	Director/D	
B.10747	West	BATHINDA	11kV	DS DIVN. RAMPURA PHUL	DS S/D BHUCHO MANDI	O332FL06	SEMA	AMR	OK	31.03.2023		AP 3Phase 3Wire				9141128	Not installed	2.610	NA	Director/D	
B.10748	West	BATHINDA	11kV	DS DIVN. RAMPURA PHUL	DS S/D BHUCHO MANDI	O332FL04	RUMMI	AMR	OK	31.03.2023		AP 3Phase 3Wire				8223701	Not installed	2.627	NA	Director/D	
B.10749	West	BATHINDA	11kV	DS DIVN. RAMPURA PHUL	DS S/D BHUCHO MANDI	O332FL15	Bhuchoo Kalan	AMR	OK	31.03.2023		AP 3Phase 3Wire				34208	Not installed	2.764	NA	Director/D	
B.10750	West	BATHINDA	11kV	DS DIVN. RAMPURA PHUL	DS S/D BHUCHO MANDI	O332FL08	LEHRA BEGA	NON AMR	OK	31.03.2023		AP 3Phase 3Wire				8223703	Not installed	2.980	NA	Director/D	
B.10751	West	BATHINDA	11kV	DS DIVN. RAMPURA PHUL	DS S/D BHUCHO MANDI	O332FL16	Baba Khem Singh ji	AMR	OK	31.03.2023		AP 3Phase 3Wire				2474	Not installed	3.101	NA	Director/D	
B.10752	West	BATHINDA	11kV	DS DIVN. RAMPURA PHUL	DS S/D BHUCHO MANDI	O332FL07	LEHRA KHANA	AMR	OK	31.03.2023		AP 3Phase 3Wire				8223702	Not installed	3.114	NA	Director/D	
B.10753	West	BATHINDA	11kV	DS DIVN. RAMPURA PHUL	DS S/D BHUCHO MANDI	O332FL03	BHUCHO MANDI	AMR	OK	31.03.2023		Category 1				12092464	Not installed	3.786	NA	Director/D	
B.10754	West	BATHINDA	11kV	DS DIVN. RAMPURA PHUL	DS S/D BHUCHO MANDI	O332FL11	AZAD	AMR	OK	31.03.2023		Category 4				10283027	Not installed	6.381	NA	Director/D	
B.10755	West	BATHINDA	11kV	DS DIVN. RAMPURA PHUL	DS S/D BHUCHO MANDI	O332FL12	Station Basti	AMR	OK	31.03.2023		Category 1				30331	Not installed	7.258	NA	Director/D	
B.10756	West	BATHINDA	11kV	DS DIVN. RAMPURA PHUL	DS S/D BHUCHO MANDI	O332FL10	BABA HIRNAM SINGH	AMR	OK	31.03.2023		Category 1				15186095	Not installed	10.215	NA	Director/D	
B.10757	West	BATHINDA	11kV	DS DIVN. RAMPURA PHUL	DS S/D BHUCHO MANDI	O332FL01	Cold Store	NON AMR	OK	31.03.2023		Category 1				9479	Not installed	10.243	NA	Director/D	
B.10758	West	BATHINDA	11kV	DS DIVN. RAMPURA PHUL	DS S/D BHUCHO MANDI	O332FL19	MAIN BAZAR	AMR	OK	31.03.2023		Category 1				3291	Not installed	12.411	NA	Director/D	
B.10759	West	BATHINDA	11kV	DS DIVN. RAMPURA PHUL	DS S/D BHUCHO MANDI	O332FL02	INDUSTRIAL	AMR	OK	31.03.2023		Category 1				30337	Not installed	15.732	NA	Director/D	
B.10760	West	BATHINDA	11kV	DS DIVN. RAMPURA PHUL	DS S/D BHUCHO MANDI	O332FL10	DRAIN AP	AMR	OK	31.03.2023		AP 3Phase 3Wire				12527356	Not installed	1.896	NA	Director/D	
B.10761	West	BATHINDA	11kV	DS DIVN. RAMPURA PHUL	DS S/D BHUCHO MANDI	O332FL04	DHAN SINGH KHANA	AMR	OK	31.03.2023		AP 3Phase 3Wire				8223541	Not installed	2.099	NA	Director/D	
B.10762	West	BATHINDA	11kV	DS DIVN. RAMPURA PHUL	DS S/D BHUCHO MANDI	O332FL02	RAIKHANA	NON AMR	OK	31.03.2023		AP 3Phase 3Wire				8223544	Not installed	2.243	NA	Director/D	
B.10763	West	BATHINDA	11kV	DS DIVN. RAMPURA PHUL	DS S/D BHUCHO MANDI	O332FL13	11 kv Chanarhal AP	AMR	OK	31.03.2023		AP 3Phase 3Wire				4460	Not installed	2.407	NA	Director/D	
B.10764	West	BATHINDA	11kV	DS DIVN. RAMPURA PHUL	DS S/D BHUCHO MANDI	O332FL09	Look Plant	AMR	OK	31.03.2023		AP 3Phase 3Wire				9154385	Not installed	2.609	NA	Director/D	
B.10765	West	BATHINDA	11kV	DS DIVN. RAMPURA PHUL	DS S/D BHUCHO MANDI	O332FL06	GILL RURAL. C.F.SINGH	NON AMR	OK	31.03.2023		AP 3Phase 3Wire				8222454	400-200/5-5	2.685	NA	Director/D	
B.10766	West	BATHINDA	11kV	DS DIVN. RAMPURA PHUL	DS S/D BHUCHO MANDI	O332FL07	Baba Momi Ji	AMR	OK	31.03.2023		AP 3Phase 3Wire				23759	400-200/5-5	2.830	NA	Director/D	
B.10767	West	BATHINDA	11kV	DS DIVN. RAMPURA PHUL	DS S/D BHUCHO MANDI	O332FL11	Baba Bahaji Ji	AMR	OK	31.03.2023		AP 3Phase 3Wire				43166	400-200/5-5	2.971	NA	Director/D	
B.10768	West	BATHINDA	11kV	DS DIVN. RAMPURA PHUL	DS S/D BHUCHO MANDI	O332FL08	CHAK FATEH SINGH WALA	NON AMR	OK	31.03.2023		AP 3Phase 3Wire				8223545	Not installed	3.231	NA	Director/D	
B.10769	West	BATHINDA	11kV	DS DIVN. RAMPURA PHUL	DS S/D BHUCHO MANDI	O332FL12	lehra khana ups	AMR	OK	31.03.2023		Category 5-U/PS				3168	Not installed	3.542	NA	Director/D	
B.10770	West	BATHINDA	11kV	DS DIVN. RAMPURA PHUL	DS S/D BHUCHO MANDI	O332FL08	Burji Khan Singh Wala	AMR	OK	31.03.2023		AP 3Phase 3Wire				43168	400-200/5-5	4.033	NA	Director/D	
B.10771	West	BATHINDA	11kV	DS DIVN. RAMPURA PHUL	DS S/D BHUCHO MANDI	O332FL03	CHAK FATEH SINGH WALA	NON AMR	OK	31.03.2023		Category 5-U/PS				43156	400-200/5-5	5.221	NA	Director/D	
B.10772	West	BATHINDA	11kV	DS DIVN. RAMPURA PHUL	DS S/D BHUCHO MANDI	O332FL05	CHAK FATEH SINGH	NON AMR	OK	31.03.2023		Category 1				7336356	Not installed	6.476	NA	Director/D	
B.10773	West	BATHINDA	11kV	DS DIVN. RAMPURA PHUL	DS S/D BHUCHO MANDI	O332FL13	DhanF13	AMR	OK	31.03.2023		AP 3Phase 3Wire				1012179	Not installed	2.015	NA	Director/D	
B.10774	West	BATHINDA	11kV	DS DIVN. RAMPURA PHUL	DS S/D BHUCHO MANDI	DhanFL02	Dhan Singh Khana	AMR	OK	31.03.2023		AP 3Phase 3Wire				10282919	Not installed	2.291	NA	Director/D	
B.10775	West	BATHINDA	11kV	DS DIVN. RAMPURA PHUL	DS S/D BHUCHO MANDI	DhanFL03	BHANDARSAR	AMR	OK	31.03.2023		AP 3Phase 3Wire				11069739	Not installed	2.330	NA	Director/D	
B.10776	West	BATHINDA	11kV	DS DIVN. RAMPURA PHUL	DS S/D BHUCHO MANDI	DhanFL01	Dhan Singh Khana cate-1	NON AMR	OK	31.03.2023		Category 1				10288370	Not installed	2.361	NA	Director/D	
B.10777	West	BATHINDA	11kV	DS DIVN. RAMPURA PHUL	DS S/D BHUCHO MANDI	X36FL06	RAMA WALA	NON AMR	OK	31.03.2023		AP 3Phase 3Wire				73112124	Not installed	1.647	NA	Director/D	
B.10778	West	BATHINDA	11kV	DS DIVN. RAMPURA PHUL	DS S/D BHUCHO MANDI	JHANFL06	Rakhana	AMR	OK	31.03.2023		AP 3Phase 3Wire				23605	Not installed	0.895	NA	Director/D	
B.10779	West	BATHINDA	11kV	DS DIVN. RAMPURA PHUL	DS S/D BHUCHO MANDI	JHANFL04	Jhan catery	AMR	OK	31.03.2023		AP 3Phase 3Wire				11052086	Not installed	1.916	NA	Director/D	
B.10780	West	BATHINDA	11kV	DS DIVN. RAMPURA PHUL	DS S/D BHUCHO MANDI	JHANFL07	Mansa Khurd	AMR	OK	31.03.2023		AP 3Phase 3Wire				10282773	Not installed	1.929	NA	Director/D	
B.10781	West	BATHINDA	11kV	DS DIVN. RAMPURA PHUL	DS S/D BHUCHO MANDI	JHANFL03	GILL	AMR	OK	31.03.2023		Category 5-U/PS				10282870	Not installed	2.115	NA	Director/D	
B.10782	West	BATHINDA	11kV	DS DIVN. RAMPURA PHUL	DS S/D BHUCHO MANDI	JHANFL02	RAIKHANA UPS	NON AMR	OK	31.03.2023		Category 5-U/PS				10282789	Not installed	2.851	NA	Director/D	
B.10783	West	BATHINDA	11kV	DS DIVN. RAMPURA PHUL	DS S/D BHUCHO MANDI	JhanF09	Gill Goshal	AMR	OK	31.03.2023		AP 3Phase 3Wire				23649	Not installed	2.879	NA	Director/D	
B.10784	West	BATHINDA	11kV	DS DIVN. RAMPURA PHUL	DS S/D BHUCHO MANDI	JHANFL01	JHANDUKE Gate-1	NON AMR	OK	31.03.2023		Category 1				10283662	Not installed	3.700	NA	Director/D	
B.10785	West	BATHINDA	11kV	DS DIVN. RAMPURA PHUL	DS S/D BHUCHO MANDI	O332FL20	gan	NON AMR	OK	31.03.2023		AP 3Phase 3Wire				3395	900-450/5	1.893	NA	Director/D	
B.10786	West	BATHINDA	11kV	DS DIVN. RAMPURA PHUL	DS S/D CITY RAMPURA PHUL	B33FL03	C H P	NON AMR	OK	31.03.2023		Category 1				7	Not installed	0.062	NA	Director/D	
B.10787	West	BATHINDA	11kV	DS DIVN. RAMPURA PHUL	DS S/D CITY RAMPURA PHUL	3530	GHTP Colony	NON AMR	OK	31.03.2023		Category 4				6	Not installed	0.126	NA	Director/D	
B.10788	West	BATHINDA	11kV	DS DIVN. RAMPURA PHUL	DS S/D CITY RAMPURA PHUL	O879FL06	Jaude pui	AMR	OK	31.03.2023		Category 1				16199609	400-200/5-5	4.481	NA	Director/D	
B.10789	West	BATHINDA	11kV	DS DIVN. RAMPURA PHUL	DS S/D CITY RAMPURA PHUL	GILLFL1	AJIT ROAD	NON AMR	OK	31.03.2023		Category 1				9848315	400-200/5-5	7.026	NA	Director/D	
B.10790	West	BATHINDA	11kV	DS DIVN. RAMPURA PHUL	DS S/D CITY RAMPURA PHUL	O334FL04	Chak catery	AMR	OK	31.03.2023		Category 1				1519704	400-200/5-5	7.351	NA	Director/D	
B.10791	West	BATHINDA	11kV	DS DIVN. RAMPURA PHUL	DS S/D CITY RAMPURA PHUL	O334FL08	ADWA LIMITED	NON AMR	OK	31.03.2023		Category 1				13517630	Not installed	0.023	NA	Director/D	
B.10792	West	BATHINDA	11kV	DS DIVN. RAMPURA PHUL	DS S/D CITY RAMPURA PHUL	O334FL14	Jhu Guru Agand Dev Ji	AMR	OK	31.03.2023		Category 4				3609	Not installed	0.198	NA	Director/D	
B.10793	West	BATHINDA	11kV	DS DIVN. RAMPURA PHUL	DS S/D CITY RAMPURA PHUL	O334FL10	COURT	NON AMR	OK	31.03.2023		Category 1				9568275	Not installed	0.381	NA	Director/D	
B.10794	West	BATHINDA	11kV	DS DIVN. RAMPURA PHUL	DS S/D CITY RAMPURA PHUL	O334FL13	College Road	AMR	OK	31.03.2023		Category 1									

S.No	Zone	Circle	Voltage Level (kVA)	Division (kVA)	Sub-Division (kVA)	Feeder ID	Feeder Name	Feeder Metering Status (Metered/unmetered/AMR/AMI)	Status of Meter (Functional/Non-Functional)	Metering Date (Date of last actual meter reading/communication)	Feeder Type (Agr/Industrial/Mixed)	Status of Communication			Period from 01.04.2021 to 31.03.2022				Sales	Remarks (Source of data)
												% data received through automatically if feeder AMR/AMI	Number of hours when meter was unable to communicate in overall	Total Number of hours in the period	Meter S.No	CT/PT ratio	Import (kWh)	Export (kWh)		
B.10834	West	BATHINDA	11KV	DS DIVN. RAMPURA PHUL	S/D S/U RAMPURA PHUL	1ETHF06	Railway Line	AMR	OK	31.03.2023	AP 3Phase 3Wire				12093583	900-450/5	3.044	NA	Director/D	
B.10835	West	BATHINDA	11KV	DS DIVN. RAMPURA PHUL	S/D S/U RAMPURA PHUL	DF106	Jaid	AMR	OK	31.03.2023	AP 3Phase 3Wire				9153994	Not installed	3.076	NA	Director/D	
B.10836	West	BATHINDA	11KV	DS DIVN. RAMPURA PHUL	S/D S/U RAMPURA PHUL	1ETHF01	1ETHURU	AMR	OK	31.03.2023	Category 1				7336694	Not installed	4.776	NA	Director/D	
B.10837	West	BATHINDA	11KV	DS DIVN. RAMPURA PHUL	S/D S/U RAMPURA PHUL	1ETHF04	BUSGAR	NON AMR	OK	31.03.2023	Category 5-UPS				7336697	Not installed	7.872	NA	Director/D	
B.10838	West	BATHINDA	11KV	DS DIVN. RAMPURA PHUL	S/D S/U RAMPURA PHUL	MNDF08	PITHO	NON AMR	OK	31.03.2023	AP 3Phase 3Wire				12345	900-450/5	1.504	NA	Director/D	
B.10839	West	BATHINDA	11KV	DS DIVN. RAMPURA PHUL	S/D S/U RAMPURA PHUL	ND02FL13	11 kv Baba dayal singh	NON AMR	OK	31.03.2023	AP 3Phase 3Wire				5606	900-450/5	1.832	NA	Director/D	
B.10840	West	BATHINDA	11KV	DS DIVN. RAMPURA PHUL	S/D S/U RAMPURA PHUL	07B2FL04	BABA KRAK DASS	NON AMR	OK	31.03.2023	AP 3Phase 3Wire				23798	900-450/5/7/1-1	2.012	NA	Director/D	
B.10841	West	BATHINDA	11KV	DS DIVN. RAMPURA PHUL	S/D S/U RAMPURA PHUL	07B2FL03	SHINMAR	NON AMR	OK	31.03.2023	AP 3Phase 3Wire				123	900-450/5	2.075	NA	Director/D	
B.10842	West	BATHINDA	11KV	DS DIVN. RAMPURA PHUL	S/D S/U RAMPURA PHUL	MNDF07	BABA TAPA	NON AMR	OK	31.03.2023	AP 3Phase 3Wire				1519474	900-450/5/7/1-1	2.406	NA	Director/D	
B.10843	West	BATHINDA	11KV	DS DIVN. RAMPURA PHUL	S/D S/U RAMPURA PHUL	07B2FL02	JEOND	AMR	OK	31.03.2023	AP 3Phase 3Wire				23497	900-450/5/7/1-1	2.668	NA	Director/D	
B.10844	West	BATHINDA	11KV	DS DIVN. RAMPURA PHUL	S/D S/U RAMPURA PHUL	07B2FL12	BABA BHULLA	NON AMR	OK	31.03.2023	AP 3Phase 3Wire				24296	900-450/5/7/1-1	2.839	NA	Director/D	
B.10845	West	BATHINDA	11KV	DS DIVN. RAMPURA PHUL	S/D S/U RAMPURA PHUL	07B2FL9	Gharela	NON AMR	OK	31.03.2023	AP 3Phase 3Wire				3942	900-450/5/7/1-1	2.940	NA	Director/D	
B.10846	West	BATHINDA	11KV	DS DIVN. RAMPURA PHUL	S/D S/U RAMPURA PHUL	07B2FL05	Joend	NON AMR	OK	31.03.2023	Category 1				1234	900-450/5	4.732	NA	Director/D	
B.10847	West	BATHINDA	11KV	DS DIVN. RAMPURA PHUL	S/D S/U RAMPURA PHUL	07B2FL01	JAI	NON AMR	OK	31.03.2023	Category 5-UPS				13190574	900-450/5/7/1-1	10.886	NA	Director/D	
B.10848	West	BATHINDA	11KV	DS DIVN. RAMPURA PHUL	S/D S/U RAMPURA PHUL	MNDF13	MAKANA	AMR	OK	31.03.2023	AP 3Phase 3Wire				15193762	900-450/5/7/1-1	1.553	NA	Director/D	
B.10849	West	BATHINDA	11KV	DS DIVN. RAMPURA PHUL	S/D S/U RAMPURA PHUL	X354FL04	Lehra Mohabbat AP	AMR	OK	31.03.2023	AP 3Phase 3Wire				4441	Not installed	1.842	NA	Director/D	
B.10850	West	BATHINDA	11KV	DS DIVN. RAMPURA PHUL	S/D S/U RAMPURA PHUL	MNDF10	Baba Pere	AMR	OK	31.03.2023	AP 3Phase 3Wire				12093480	900-450/5/7/1-1	2.090	NA	Director/D	
B.10851	West	BATHINDA	11KV	DS DIVN. RAMPURA PHUL	S/D S/U RAMPURA PHUL	MNDF05	MANDI KALAN	AMR	OK	31.03.2023	AP 3Phase 3Wire				9154302	Not installed	2.223	NA	Director/D	
B.10852	West	BATHINDA	11KV	DS DIVN. RAMPURA PHUL	S/D S/U RAMPURA PHUL	MNDF03	DHADE	AMR	OK	31.03.2023	AP 3Phase 3Wire				10273808	Not installed	2.395	NA	Director/D	
B.10853	West	BATHINDA	11KV	DS DIVN. RAMPURA PHUL	S/D S/U RAMPURA PHUL	MNDF04	BHINDER	NON AMR	OK	31.03.2023	Category 5-UPS				9154478	Not installed	2.626	NA	Director/D	
B.10854	West	BATHINDA	11KV	DS DIVN. RAMPURA PHUL	S/D S/U RAMPURA PHUL	MNDF02	PITHO	AMR	OK	31.03.2023	AP 3Phase 3Wire				9154356	900-450/5/7/1-1	2.754	NA	Director/D	
B.10855	West	BATHINDA	11KV	DS DIVN. RAMPURA PHUL	S/D S/U RAMPURA PHUL	MNDF06	Badyala	AMR	OK	31.03.2023	AP 3Phase 3Wire				11116818	Not installed	2.825	NA	Director/D	
B.10856	West	BATHINDA	11KV	DS DIVN. RAMPURA PHUL	S/D S/U RAMPURA PHUL	MNDF01	MODIHANA	NON AMR	OK	31.03.2023	AP 3Phase 3Wire				9534486	Not installed	3.420	NA	Director/D	
B.10857	West	BATHINDA	11KV	DS DIVN. RAMPURA PHUL	S/D S/U RAMPURA PHUL	MNDF12	COLLAGE ROAD	AMR	OK	31.03.2023	AP 3Phase 3Wire				9154356	900-450/5/7/1-1	3.706	NA	Director/D	
B.10858	West	BATHINDA	11KV	DS DIVN. RAMPURA PHUL	S/D S/U RAMPURA PHUL	MNDF07	DHADE	AMR	OK	31.03.2023	Category 5-UPS				9154421	Not installed	4.102	NA	Director/D	
B.10859	West	BATHINDA	11KV	DS DIVN. RAMPURA PHUL	S/D S/U RAMPURA PHUL	MNDF08	INDUSTRIES	NON AMR	OK	31.03.2023	Category 1				9154009	Not installed	6.016	NA	Director/D	
B.10860	West	BATHINDA	11KV	DS DIVN. RAMPURA PHUL	S/D S/U RAMPURA PHUL	MNDF11	BARI SAHIB	NON AMR	OK	31.03.2023	Category 5-UPS				12092446	Not installed	7.550	NA	Director/D	
B.10861	West	BATHINDA	11KV	DS DIVN. RAMPURA PHUL	S/D S/U RAMPURA PHUL	MNDF01	MANDI KALAN	AMR	OK	31.03.2023	Category 1				9154400	900-450/5/7/1-1	10.057	NA	Director/D	
B.10862	West	BATHINDA	11KV	DS DIVN. RAMPURA PHUL	S/D S/U RAMPURA PHUL	MEHRF02	MEHRAJ	NON AMR	OK	31.03.2023	AP 3Phase 3Wire				10273754	900-450/5/7/1-1	1.768	NA	Director/D	
B.10863	West	BATHINDA	11KV	DS DIVN. RAMPURA PHUL	S/D S/U RAMPURA PHUL	mehrf11	Baba kala	AMR	OK	31.03.2023	AP 3Phase 3Wire				43141	400-200/5	2.478	NA	Director/D	
B.10864	West	BATHINDA	11KV	DS DIVN. RAMPURA PHUL	S/D S/U RAMPURA PHUL	MEHRF04	GURUSAR	NON AMR	OK	31.03.2023	AP 3Phase 3Wire				5722469	900-450/5/7/1-1	3.523	NA	Director/D	
B.10865	West	BATHINDA	11KV	DS DIVN. RAMPURA PHUL	S/D S/U RAMPURA PHUL	mehrf10	PIL SAHIB	NON AMR	OK	31.03.2023	Category 5-UPS				290456	400-200/5	3.706	NA	Director/D	
B.10866	West	BATHINDA	11KV	DS DIVN. RAMPURA PHUL	S/D S/U RAMPURA PHUL	MEHRF06	PIPLI	AMR	OK	31.03.2023	Category 5-UPS				23582	900-450/5/7/1-1	4.749	NA	Director/D	
B.10867	West	BATHINDA	11KV	DS DIVN. RAMPURA PHUL	S/D S/U RAMPURA PHUL	MEHRF03	INDUSTRIES	NON AMR	OK	31.03.2023	Category 1				10273725	900-450/5/7/1-1	9.416	NA	Director/D	
B.10868	West	BATHINDA	11KV	DS DIVN. RAMPURA PHUL	S/D S/U RAMPURA PHUL	MEHRF01	Mehraj	AMR	OK	31.03.2023	Category 1				43162	400-200/5	12.341	NA	Director/D	
B.10869	West	BATHINDA	11KV	DS DIVN. RAMPURA PHUL	S/D S/U RAMPURA PHUL	0354FL09	GILL	AMR	OK	31.03.2023	AP 3Phase 3Wire				8223708	Not installed	0.837	NA	Director/D	
B.10870	West	BATHINDA	11KV	DS DIVN. RAMPURA PHUL	S/D S/U RAMPURA PHUL	0354FL17	DHINGER	AMR	OK	31.03.2023	AP 3Phase 3Wire				1503763	Not installed	1.529	NA	Director/D	
B.10871	West	BATHINDA	11KV	DS DIVN. RAMPURA PHUL	S/D S/U RAMPURA PHUL	0354FL03	MEHRAJ	AMR	OK	31.03.2023	AP 3Phase 3Wire				8223710	Not installed	1.863	NA	Director/D	
B.10872	West	BATHINDA	11KV	DS DIVN. RAMPURA PHUL	S/D S/U RAMPURA PHUL	0354FL00	DHPALJ AP (PHUL)	AMR	OK	31.03.2023	AP 3Phase 3Wire				9568130	Not installed	2.469	NA	Director/D	
B.10873	West	BATHINDA	11KV	DS DIVN. RAMPURA PHUL	S/D S/U RAMPURA PHUL	0354FL16	SAUL PATTI AP	AMR	OK	31.03.2023	AP 3Phase 3Wire				3963	Not installed	2.536	NA	Director/D	
B.10874	West	BATHINDA	11KV	DS DIVN. RAMPURA PHUL	S/D S/U RAMPURA PHUL	0354FL6	Maluana	AMR	OK	31.03.2023	AP 3Phase 3Wire				9568282	Not installed	2.700	NA	Director/D	
B.10875	West	BATHINDA	11KV	DS DIVN. RAMPURA PHUL	S/D S/U RAMPURA PHUL	0354FL15	BURJ	AMR	OK	31.03.2023	AP 3Phase 3Wire				6693983	Not installed	2.720	NA	Director/D	
B.10876	West	BATHINDA	11KV	DS DIVN. RAMPURA PHUL	S/D S/U RAMPURA PHUL	0354FL05	POTTA	AMR	OK	31.03.2023	AP 3Phase 3Wire				8223709	Not installed	3.494	NA	Director/D	
B.10877	West	BATHINDA	11KV	DS DIVN. RAMPURA PHUL	S/D S/U RAMPURA PHUL	0354FL24	BABA SIDH	NON AMR	OK	31.03.2023	AP 3Phase 3Wire				23689	900-450/5/7/1-1	1.515	NA	Director/D	
B.10878	West	BATHINDA	11KV	DS DIVN. RAMPURA PHUL	S/D S/U RAMPURA PHUL	0354FL26	Tirvani	NON AMR	OK	31.03.2023	AP 3Phase 3Wire				23456	900-450/5/7/1-1	1.489	NA	Director/D	
B.10879	West	BATHINDA	11KV	DS DIVN. RAMPURA PHUL	S/D S/U RAMPURA PHUL	0354FL23	LAKAR DAS	AMR	OK	31.03.2023	AP 3Phase 3Wire				13190536	900-450/5/7/1-1	1.884	NA	Director/D	
B.10880	West	BATHINDA	11KV	DS DIVN. RAMPURA PHUL	S/D S/U RAMPURA PHUL	0354FL25	U S A	AMR	OK	31.03.2023	AP 3Phase 3Wire				29764	900-450/5/7/1-1	2.160	NA	Director/D	
B.10881	West	BATHINDA	11KV	DS DIVN. RAMPURA PHUL	S/D S/U RAMPURA PHUL	0354FL14	RAMPWALA	AMR	OK	31.03.2023	AP 3Phase 3Wire				8222623	Not installed	2.026	NA	Director/D	
B.10882	West	BATHINDA	11KV	DS DIVN. RAMPURA PHUL	S/D S/U RAMPURA PHUL	0354FL02	DHADE	AMR	OK	31.03.2023	AP 3Phase 3Wire				8222625	Not installed	2.625	NA	Director/D	
B.10883	West	BATHINDA	11KV	DS DIVN. RAMPURA PHUL	S/D S/U RAMPURA PHUL	0354FL06	BHINDER	AMR	OK	31.03.2023	AP 3Phase 3Wire				8222622	Not installed	2.759	NA	Director/D	
B.10884	West	BATHINDA	11KV	DS DIVN. RAMPURA PHUL	S/D S/U RAMPURA PHUL	0354FL01	PITHO	AMR	OK	31.03.2023	AP 3Phase 3Wire				9568217	Not installed	2.811	NA	Director/D	
B.10885	West	BATHINDA	11KV	DS DIVN. RAMPURA PHUL	S/D S/U RAMPURA PHUL	0354FL17	1ETHURU	AMR	OK	31.03.2023	AP 3Phase 3Wire				8222625	Not installed	2.838	NA	Director/D	
B.10886	West	BATHINDA	11KV	DS DIVN. RAMPURA PHUL	S/D S/U RAMPURA PHUL	0354FL07	BURI NANSA	AMR	OK	31.03.2023	AP 3Phase 3Wire				8222621	Not installed	3.340	NA	Director/D	
B.10887	West	BATHINDA	11KV	DS DIVN. RAMPURA PHUL	S/D S/U RAMPURA PHUL	0354FL08	GILL KALAN	AMR	OK	31.03.2023	Category 5-UPS				9568132	Not installed	3.574	NA	Director/D	
B.10888	West	FARIKOT	11KV	DS CITY DIVN. MOGA	S/D BHINDER KALAN	C410FL14	JALALABAD AP	AMR	OK	31.03.2023	AP 3Phase 3Wire				2067524	1200-600/5	2.493	NA	Director/D	
B.10889	West	FARIKOT	11KV	DS CITY DIVN. MOGA	S/D BHINDER KALAN	0412FL09	JINDRA	AMR	OK	31.03.2023	AP 3Phase 3Wire				6761965	900-450/5/7/1-1	0.855	NA	Director/D	
B.10890	West	FARIKOT	11KV	DS CITY DIVN. MOGA	S/D BHINDER KALAN	0431FL02	BABA KALA MEHAR	AMR	OK	31.03.2023	AP 3Phase 3Wire				8223203	900-450/5/7/1-1	1.239	NA	Director/D	
B.10891	West	FARIKOT	11KV	DS CITY DIVN. MOGA	S/D BHINDER KALAN	0431FL08	WADHAWA	AMR	OK	31.03.2023	AP 3Phase 3Wire				8223340	900-450/5/7/1-1	1.382	NA	Director/D	
B.10892	West	FARIKOT	11KV	DS CITY DIVN. MOGA	S/D BHINDER KALAN	0431FL11	11 KV PATTILA AP	AMR	OK	31.										

S.No	Zone	Circle	Voltage Level (kVA)	Division (kVA)	Sub-Division (kVA)	Feeder ID	Feeder Name	Feeder Metering Status (Metered/unmetered/AMR/AMI)	Status of Meter (Functional/Non-Functional)	Metering Date (Date of last actual meter reading/communication)	Feeder Type (Agr/Industrial/Mixed)	Status of Communication			Period from 01.04.2021 to 31.03.2022				Sales	Remarks (Source of data)
												% data received through automatically if feeder AMR/AMI	Number of hours when meter was unable to communicate in overall	Total Number of hours in the period	Meter S.No	CT/PT ratio	Import (kWh)	Export (kWh)		
B.10931	West	FARIDKOT	11KV	DS CITY DIVN. MOGA	DS S/D DAGRU	C412FL07	SOSAN URBAN.	AMR	OK	31.03.2023	Category 1				7042850	900-450/5	1.298	NA	Director/D	
B.10932	West	FARIDKOT	11KV	DS CITY DIVN. MOGA	DS S/D DAGRU	C412FL12	11KV Khuhra (KOREWALA KHURD)	AMR	OK	31.03.2023	AP 3Phase 3Wire				111111	900-450/5	1.398	NA	Director/D	
B.10933	West	FARIDKOT	11KV	DS CITY DIVN. MOGA	DS S/D DAGRU	C412FL13	11 KV Dhadhoor (SOSANI AP)	AMR	OK	31.03.2023	AP 3Phase 3Wire				111111	900-450/5	1.485	NA	Director/D	
B.10934	West	FARIDKOT	11KV	DS CITY DIVN. MOGA	DS S/D DAGRU	C412FL01	KOREWALA KALAN	NON AMR	OK	31.03.2023	AP 3Phase 3Wire				8223303	900-450/5	1.683	NA	Director/D	
B.10935	West	FARIDKOT	11KV	DS CITY DIVN. MOGA	DS S/D DAGRU	C412FL09	11 KV Mahesh Muni AP	AMR	OK	31.03.2023	AP 3Phase 3Wire				11111	900-450/5	1.697	NA	Director/D	
B.10936	West	FARIDKOT	11KV	DS CITY DIVN. MOGA	DS S/D DAGRU	C412FL03	BAGHLEWALA	AMR	OK	31.03.2023	AP 3Phase 3Wire				8223302	900-450/5	1.842	NA	Director/D	
B.10937	West	FARIDKOT	11KV	DS CITY DIVN. MOGA	DS S/D DAGRU	C412FL02	THAMANWALA	AMR	OK	31.03.2023	AP 3Phase 3Wire				8223301	900-450/5	2.203	NA	Director/D	
B.10938	West	FARIDKOT	11KV	DS CITY DIVN. MOGA	DS S/D DAGRU	C412FL06	KORE WALA KHURAD	AMR	OK	31.03.2023	AP 3Phase 3Wire				8223305	900-450/5	2.382	NA	Director/D	
B.10939	West	FARIDKOT	11KV	DS CITY DIVN. MOGA	DS S/D DAGRU	C412FL08	KAMAL KE UPS	AMR	OK	31.03.2023	Category 5-U/PS				311111111	900-450/5	5.208	NA	Director/D	
B.10940	West	FARIDKOT	11KV	DS CITY DIVN. MOGA	DS S/D DAGRU	C412FL05	JOGEWALA	AMR	OK	31.03.2023	Category 5-U/PS				7042821	900-450/5	5.381	NA	Director/D	
B.10941	West	FARIDKOT	11KV	DS CITY DIVN. MOGA	DS S/D DAGRU	8401FL09	DROLI BHA (Ghal Kalan UPS)	AMR	OK	31.03.2023	Category 5-U/PS				7030208	1200-600/5	5.026	NA	Director/D	
B.10942	West	FARIDKOT	11KV	DS CITY DIVN. MOGA	DS S/D DAGRU	8401FL07	SAFUWALA	AMR	OK	31.03.2023	AP 3Phase 3Wire				8223308	1200-600/5	2.864	NA	Director/D	
B.10943	West	FARIDKOT	11KV	DS CITY DIVN. MOGA	DS S/D DAGRU	8401FL15	GHAL DAROLI	NON AMR	OK	31.03.2023	AP 3Phase 3Wire				1111499	1200-600/5	3.593	NA	Director/D	
B.10944	West	FARIDKOT	11KV	DS CITY DIVN. MOGA	DS S/D DAGRU	8401FL06	GHAL BIR	AMR	OK	31.03.2023	AP 3Phase 3Wire				8223113	1200-600/5	3.750	NA	Director/D	
B.10945	West	FARIDKOT	11KV	DS CITY DIVN. MOGA	DS S/D DAGRU	0409FL09	KHANI AGRO INDEPENDENT	AMR	OK	31.03.2023	Category 4				738429	1200/577/1-1	0.317	NA	Director/D	
B.10946	West	FARIDKOT	11KV	DS CITY DIVN. MOGA	DS S/D DAGRU	0409FL20	11 KV kotha AP	AMR	OK	31.03.2023	AP 3Phase 3Wire				111111111	1200/577/1-1	1.128	NA	Director/D	
B.10947	West	FARIDKOT	11KV	DS CITY DIVN. MOGA	DS S/D DAGRU	0409FL18	SHAHU KARAN WALA	AMR	OK	31.03.2023	AP 3Phase 3Wire				11114508	900-450/5	1.424	NA	Director/D	
B.10948	West	FARIDKOT	11KV	DS CITY DIVN. MOGA	DS S/D DAGRU	0409FL12	KHOSA PANDO	AMR	OK	31.03.2023	AP 3Phase 3Wire				8223274	900-450/5	1.608	NA	Director/D	
B.10949	West	FARIDKOT	11KV	DS CITY DIVN. MOGA	DS S/D DAGRU	0409FL17	SADA SINGH WALA	AMR	OK	31.03.2023	AP 3Phase 3Wire				2065776	1200/577/1-1	1.650	NA	Director/D	
B.10950	West	FARIDKOT	11KV	DS CITY DIVN. MOGA	DS S/D DAGRU	0409FL07	DADANDOOR	AMR	OK	31.03.2023	AP 3Phase 3Wire				8222515	1200/577/1-1	1.656	NA	Director/D	
B.10951	West	FARIDKOT	11KV	DS CITY DIVN. MOGA	DS S/D DAGRU	0409FL14	RHUHRAMA	AMR	OK	31.03.2023	AP 3Phase 3Wire				8223750	1200/577/1-1	2.059	NA	Director/D	
B.10952	West	FARIDKOT	11KV	DS CITY DIVN. MOGA	DS S/D DAGRU	0409FL05	SALINA	AMR	OK	31.03.2023	AP 3Phase 3Wire				8223275	1200/577/1-1	2.098	NA	Director/D	
B.10953	West	FARIDKOT	11KV	DS CITY DIVN. MOGA	DS S/D DAGRU	0409FL13	KAHAN SINGH WALA	AMR	OK	31.03.2023	AP 3Phase 3Wire				6607212	1200/577/1-1	2.125	NA	Director/D	
B.10954	West	FARIDKOT	11KV	DS CITY DIVN. MOGA	DS S/D DAGRU	0409FL01	JOGEWALA AP	AMR	OK	31.03.2023	AP 3Phase 3Wire				8223305	1200/577/1-1	2.133	NA	Director/D	
B.10955	West	FARIDKOT	11KV	DS CITY DIVN. MOGA	DS S/D DAGRU	0409FL15	BABA LAL SINGH	AMR	OK	31.03.2023	AP 3Phase 3Wire				6745327	900-450/5	2.171	NA	Director/D	
B.10956	West	FARIDKOT	11KV	DS CITY DIVN. MOGA	DS S/D DAGRU	0409FL10	GAJIANWALA	AMR	OK	31.03.2023	AP 3Phase 3Wire				8223272	900-450/5	2.328	NA	Director/D	
B.10957	West	FARIDKOT	11KV	DS CITY DIVN. MOGA	DS S/D DAGRU	0409FL04	THANA SADAR	AMR	OK	31.03.2023	AP 3Phase 3Wire				5342481	1200/577/1-1	2.417	NA	Director/D	
B.10958	West	FARIDKOT	11KV	DS CITY DIVN. MOGA	DS S/D DAGRU	0409FL06	PHATHANGARH	AMR	OK	31.03.2023	AP 3Phase 3Wire				8223048	1200/577/1-1	2.507	NA	Director/D	
B.10959	West	FARIDKOT	11KV	DS CITY DIVN. MOGA	DS S/D DAGRU	0409FL08	DROLI BHAJ	AMR	OK	31.03.2023	AP 3Phase 3Wire				9141106	1200/577/1-1	2.730	NA	Director/D	
B.10960	West	FARIDKOT	11KV	DS CITY DIVN. MOGA	DS S/D DAGRU	0409FL19	JALDARAN WALA	AMR	OK	31.03.2023	AP 3Phase 3Wire				2067371	900-450/5	3.032	NA	Director/D	
B.10961	West	FARIDKOT	11KV	DS CITY DIVN. MOGA	DS S/D DAGRU	0409FL03	DEGRI	AMR	OK	31.03.2023	Category 5-U/PS				7384444	1200/577/1-1	7.426	NA	Director/D	
B.10962	West	FARIDKOT	11KV	DS CITY DIVN. MOGA	DS S/D DAGRU	0409FL11	NIDHANWALA	AMR	OK	31.03.2023	Category 5-U/PS				2065674	1200/577/1-1	7.446	NA	Director/D	
B.10963	West	FARIDKOT	11KV	DS CITY DIVN. MOGA	DS S/D DAGRU	0409FL16	Green City UPS	AMR	OK	31.03.2023	Category 1				11111	900-450/5	9.186	NA	Director/D	
B.10964	West	FARIDKOT	11KV	DS CITY DIVN. MOGA	DS S/D DAGRU	0410FL11	SAMRA AP	AMR	OK	31.03.2023	AP 3Phase 3Wire				5286	1200/577/1-1	0.440	NA	Director/D	
B.10965	West	FARIDKOT	11KV	DS CITY DIVN. MOGA	DS S/D DAGRU	0410FL03	MEHINGA SINGH AP	AMR	OK	31.03.2023	AP 3Phase 3Wire				2065804	1200/577/1-1	1.756	NA	Director/D	
B.10966	West	FARIDKOT	11KV	DS CITY DIVN. MOGA	DS S/D DAGRU	0410FL01	DALPAT PURA	AMR	OK	31.03.2023	AP 3Phase 3Wire				4221137	1200/577/1-1	1.813	NA	Director/D	
B.10967	West	FARIDKOT	11KV	DS CITY DIVN. MOGA	DS S/D DAGRU	0410FL07	KILLA PUR	AMR	OK	31.03.2023	AP 3Phase 3Wire				11069278	1200/577/1-1	1.857	NA	Director/D	
B.10968	West	FARIDKOT	11KV	DS CITY DIVN. MOGA	DS S/D DAGRU	0410FL04	ATARI	AMR	OK	31.03.2023	AP 3Phase 3Wire				8223047	1200/577/1-1	2.182	NA	Director/D	
B.10969	West	FARIDKOT	11KV	DS CITY DIVN. MOGA	DS S/D DAGRU	0410FL06	DALPAT PURA/GURUSAR	AMR	OK	31.03.2023	Category 5-U/PS				9534577	1200/577/1-1	4.072	NA	Director/D	
B.10970	West	FARIDKOT	11KV	DS CITY DIVN. MOGA	DS S/D DAGRU	0429FL13	11 KV KMALGARH AP	AMR	OK	31.03.2023	AP 3Phase 3Wire				54321	900-450/577/1-1	0.919	NA	Director/D	
B.10971	West	FARIDKOT	11KV	DS CITY DIVN. MOGA	DS S/D DAGRU	0429FL06	GAJIAN WALA/DADAHOOR	AMR	OK	31.03.2023	AP 3Phase 3Wire				7384627	900-450/577/1-1	1.835	NA	Director/D	
B.10972	West	FARIDKOT	11KV	DS CITY DIVN. MOGA	DS S/D DAGRU	0429FL03	Safuwala New	AMR	OK	31.03.2023	AP 3Phase 3Wire				21190	900-450/577/1-1	1.846	NA	Director/D	
B.10973	West	FARIDKOT	11KV	DS CITY DIVN. MOGA	DS S/D DAGRU	0409FL14	NIDHANWALA	AMR	OK	31.03.2023	AP 3Phase 3Wire				2065123	900-450/577/1-1	1.927	NA	Director/D	
B.10974	West	FARIDKOT	11KV	DS CITY DIVN. MOGA	DS S/D DAGRU	0409FL11	MANGE WALA OLD	AMR	OK	31.03.2023	AP 3Phase 3Wire				9156165	900-450/577/1-1	2.264	NA	Director/D	
B.10975	West	FARIDKOT	11KV	DS CITY DIVN. MOGA	DS S/D DHARAMKOT	C410FL16	LOHGARH-2 AP	AMR	OK	31.03.2023	AP 3Phase 3Wire				1028284	1200-600/5	1.375	NA	Director/D	
B.10976	West	FARIDKOT	11KV	DS CITY DIVN. MOGA	DS S/D DHARAMKOT	C410FL13	LOHGARH-1 AP	AMR	OK	31.03.2023	AP 3Phase 3Wire				1028308	1200-600/5	1.545	NA	Director/D	
B.10977	West	FARIDKOT	11KV	DS CITY DIVN. MOGA	DS S/D DHARAMKOT	C410FL04	Bageewal AP	AMR	OK	31.03.2023	AP 3Phase 3Wire				7442128	1200-600/5	1.558	NA	Director/D	
B.10978	West	FARIDKOT	11KV	DS CITY DIVN. MOGA	DS S/D DHARAMKOT	C410FL05	KAMAL KE UPS	AMR	OK	31.03.2023	Category 5-U/PS				2065809	1200-600/5	2.202	NA	Director/D	
B.10979	West	FARIDKOT	11KV	DS CITY DIVN. MOGA	DS S/D DHARAMKOT	C410FL15	KARYAL LISBAN	AMR	OK	31.03.2023	Category 1				64925	1200-600/5	2.374	NA	Director/D	
B.10980	West	FARIDKOT	11KV	DS CITY DIVN. MOGA	DS S/D DHARAMKOT	C410FL10	CHEEMAJAP	AMR	OK	31.03.2023	AP 3Phase 3Wire				7424131	1200-600/5	2.619	NA	Director/D	
B.10981	West	FARIDKOT	11KV	DS CITY DIVN. MOGA	DS S/D DHARAMKOT	C410FL09	MAJUGARH AP	AMR	OK	31.03.2023	AP 3Phase 3Wire				10282997	1200-600/5	2.903	NA	Director/D	
B.10982	West	FARIDKOT	11KV	DS CITY DIVN. MOGA	DS S/D DHARAMKOT	C410FL11	BADUWAL AP	AMR	OK	31.03.2023	AP 3Phase 3Wire				10282828	1200-600/5	2.918	NA	Director/D	
B.10983	West	FARIDKOT	11KV	DS CITY DIVN. MOGA	DS S/D DHARAMKOT	C410FL06	KOT SADAR KHAN AP	AMR	OK	31.03.2023	AP 3Phase 3Wire				8223783	1200-600/5	2.964	NA	Director/D	
B.10984	West	FARIDKOT	11KV	DS CITY DIVN. MOGA	DS S/D DHARAMKOT	C410FL02	Phowal AP	AMR	OK	31.03.2023	AP 3Phase 3Wire				10283971	1200-600/5	3.109	NA	Director/D	
B.10985	West	FARIDKOT	11KV	DS CITY DIVN. MOGA	DS S/D DHARAMKOT	C410FL01	KARYAL AP	AMR	OK	31.03.2023	AP 3Phase 3Wire				8223785	1200-600/5	3.284	NA	Director/D	
B.10986	West	FARIDKOT	11KV	DS CITY DIVN. MOGA	DS S/D DHARAMKOT	C410FL15	CHEEMA	AMR	OK	31.03.2023	Category 5-U/PS				7424133	1200-600/5	4.357	NA	Director/D	
B.10987	West	FARIDKOT	11KV	DS CITY DIVN. MOGA	DS S/D DHARAMKOT	C410FL07	DHARAMKOT	AMR	OK	31.03.2023	Category 1				10288297	1200-600/5	10.965	NA	Director/D	
B.10988	West	FARIDKOT	11KV	DS CITY DIVN. MOGA	DS S/D DHARAMKOT	0412FL12	Pandori AP	AMR	OK	31.03.2023	AP 3Phase 3Wire				12527861					

S.No	Zone	Circle	Voltage Level (kVA)	Division (kVA)	Sub-Division (kVA)	Feeder ID	Feeder Name	Feeder Metering Status (Meters/ un-metered/ AM/AMR)	Status of Meter (Functional/Non-Functional)	Metering Date (Date of last actual meter reading/ communication)	Feeder Type (Agr/ Industrial/Mixed)	Status of Communication			Period from 01.04.2021 to 31.03.2022				Sales	Remarks (Source of data)
												% data received through automatically if feeder AMR/AMI	Number of hours when meter was unable to communicate in overall	Total Number of hours in the period	Meter S.No	CT/PT ratio	Import (kU)	Export (kU)		
B.11028	West	FARIDKOT	11KV	DS CITY DIVN. MOGA	DS S/D DHARAMKOT	D449FL02	11 KV Sabuana	AMR	OK	31.03.2023	AP 3Phase 3Wire				3637	900-450/577/1-1-1	1,916	NA	Director/D	
B.11029	West	FARIDKOT	11KV	DS CITY DIVN. MOGA	DS S/D DHARAMKOT	D449FL01	11 KV LOHGARRH URBAN FEEDER	NON AMR	OK	31.03.2023	Category 5-UPS				3634	900-450/577/1-1-1	3,333	NA	Director/D	
B.11030	West	FARIDKOT	11KV	DS CITY DIVN. MOGA	DS S/D F/PANITOOR	D435FL07	11 KV Ramgarh	AMR	OK	31.03.2023	AP 3Phase 3Wire				1111111	1200/577/1-1-1	1,700	NA	Director/D	
B.11031	West	FARIDKOT	11KV	DS CITY DIVN. MOGA	DS S/D F/PANITOOR	D435FL10	11 KV Mandhir Kalan AP	AMR	OK	31.03.2023	AP 3Phase 3Wire				9534366	1200/577/1-1-1	2,263	NA	Director/D	
B.11032	West	FARIDKOT	11KV	DS CITY DIVN. MOGA	DS S/D F/PANITOOR	D435FL06	BHANWAL	AMR	OK	31.03.2023	AP 3Phase 3Wire				9534366	1200/577/1-1-1	2,263	NA	Director/D	
B.11033	West	FARIDKOT	11KV	DS CITY DIVN. MOGA	DS S/D F/PANITOOR	D456FL06	KARAEH WALA	AMR	OK	31.03.2023	AP 3Phase 3Wire				10572064	1200/577/1-1-1	1,420	NA	Director/D	
B.11034	West	FARIDKOT	11KV	DS CITY DIVN. MOGA	DS S/D F/PANITOOR	D456FL02	KHANNA	AMR	OK	31.03.2023	AP 3Phase 3Wire				6607235	1200/577/1-1-1	1,829	NA	Director/D	
B.11035	West	FARIDKOT	11KV	DS CITY DIVN. MOGA	DS S/D F/PANITOOR	D456FL13	Mahli Machhi AP	AMR	OK	31.03.2023	AP 3Phase 3Wire				7513311	Not installed	1,865	NA	Director/D	
B.11036	West	FARIDKOT	11KV	DS CITY DIVN. MOGA	DS S/D F/PANITOOR	U107D456	UFS No.5 FGP	AMR	OK	31.03.2023	Category 5-UPS				4407	Not installed	NA	NA	Director/D	
B.11037	West	FARIDKOT	11KV	DS CITY DIVN. MOGA	DS S/D F/PANITOOR	D456FL18	DHARM SINGH WALA	AMR	OK	31.03.2023	AP 3Phase 3Wire				11117047	1200/577/1-1-1	2,248	NA	Director/D	
B.11038	West	FARIDKOT	11KV	DS CITY DIVN. MOGA	DS S/D F/PANITOOR	D456FL09	MOJIE WALA	AMR	OK	31.03.2023	AP 3Phase 3Wire				11116995	1200/577/1-1-1	3,298	NA	Director/D	
B.11039	West	FARIDKOT	11KV	DS CITY DIVN. MOGA	DS S/D F/PANITOOR	D456FL11	mundi jama+ Droli Khera	AMR	OK	31.03.2023	AP 3Phase 3Wire				6675947	1200/577/1-1-1	3,437	NA	Director/D	
B.11040	West	FARIDKOT	11KV	DS CITY DIVN. MOGA	DS S/D F/PANITOOR	D456FL08	RAJIAN WALA+Mahli Machhi+Salde Sh	AMR	OK	31.03.2023	AP 3Phase 3Wire				6675954	1200/577/1-1-1	3,606	NA	Director/D	
B.11041	West	FARIDKOT	11KV	DS CITY DIVN. MOGA	DS S/D F/PANITOOR	D456FL12	UFS No.2 FGP	AMR	OK	31.03.2023	Category 5-UPS				8222613	1200/577/1-1-1	3,853	NA	Director/D	
B.11042	West	FARIDKOT	11KV	DS CITY DIVN. MOGA	DS S/D F/PANITOOR	D456FL01	UFS No.1 FGP	AMR	OK	31.03.2023	Category 5-UPS				5489721	1200/577/1-1-1	4,211	NA	Director/D	
B.11043	West	FARIDKOT	11KV	DS CITY DIVN. MOGA	DS S/D F/PANITOOR	D456FL03	FATEHGARH PANITOOR	AMR	OK	31.03.2023	Category 1				11052052	1200/577/1-1-1	6,938	NA	Director/D	
B.11044	West	FARIDKOT	11KV	DS CITY DIVN. MOGA	DS S/D F/PANITOOR	D456FL14	UFS No-4	AMR	OK	31.03.2023	Category 1				1111111	Not installed	7,469	NA	Director/D	
B.11045	West	FARIDKOT	11KV	DS CITY DIVN. MOGA	DS S/D F/PANITOOR	B454E10	KARAEH WALA NEW	NON AMR	OK	31.03.2023	AP 3Phase 3Wire				23849	1200/577/1-1-1	1,534	NA	Director/D	
B.11046	West	FARIDKOT	11KV	DS CITY DIVN. MOGA	DS S/D KOT ISE KHAN	C409FL15	LOHARA AP	AMR	OK	31.03.2023	AP 3Phase 3Wire				8223502	400-200/5-5	2,522	NA	Director/D	
B.11047	West	FARIDKOT	11KV	DS CITY DIVN. MOGA	DS S/D KOT ISE KHAN	D451FL22	SHERPUR AP-2	AMR	OK	31.03.2023	AP 3Phase 3Wire				5340	1200-600/5	0,745	NA	Director/D	
B.11048	West	FARIDKOT	11KV	DS CITY DIVN. MOGA	DS S/D KOT ISE KHAN	D451FL21	MANDIR NEW AP	AMR	OK	31.03.2023	AP 3Phase 3Wire				15198588	1200-600/5	0,906	NA	Director/D	
B.11049	West	FARIDKOT	11KV	DS CITY DIVN. MOGA	DS S/D KOT ISE KHAN	D451FL21	MANDIR AP-2	AMR	OK	31.03.2023	AP 3Phase 3Wire				5242	1200-600/5	1,133	NA	Director/D	
B.11050	West	FARIDKOT	11KV	DS CITY DIVN. MOGA	DS S/D KOT ISE KHAN	D451FL12	MANDIR (Sherpur JAP	AMR	OK	31.03.2023	AP 3Phase 3Wire				777205	1200-600/5	1,304	NA	Director/D	
B.11051	West	FARIDKOT	11KV	DS CITY DIVN. MOGA	DS S/D KOT ISE KHAN	D451FL06	JHANDA BAGGA AP	AMR	OK	31.03.2023	AP 3Phase 3Wire				4221144	1200-600/5	1,994	NA	Director/D	
B.11052	West	FARIDKOT	11KV	DS CITY DIVN. MOGA	DS S/D KOT ISE KHAN	D451FL13	URBAN-SIMANDIRI NEW	AMR	OK	31.03.2023	Category 5-UPS				9534399	1200/577/1-1-1	4,682	NA	Director/D	
B.11053	West	FARIDKOT	11KV	DS CITY DIVN. MOGA	DS S/D KOT ISE KHAN	D419FL13	WAZA CHAIN SINGH WALA	AMR	OK	31.03.2023	AP 3Phase 3Wire				5363	1200/577/1-1-1	0,788	NA	Director/D	
B.11054	West	FARIDKOT	11KV	DS CITY DIVN. MOGA	DS S/D KOT ISE KHAN	D409FL02	JMIRIANA AP	AMR	OK	31.03.2023	AP 3Phase 3Wire				5295552	1200/577/1-1-1	1,591	NA	Director/D	
B.11055	West	FARIDKOT	11KV	DS CITY DIVN. MOGA	DS S/D KOT ISE KHAN	D410FL05	CHUHAR CHAK AP	AMR	OK	31.03.2023	AP 3Phase 3Wire				2047059	1200/577/1-1-1	1,695	NA	Director/D	
B.11056	West	FARIDKOT	11KV	DS CITY DIVN. MOGA	DS S/D KOT ISE KHAN	D410FL09	11 KV Chuhar Chak 2 AP	AMR	OK	31.03.2023	AP 3Phase 3Wire				1111111	1200/577/1-1-1	2,253	NA	Director/D	
B.11057	West	FARIDKOT	11KV	DS CITY DIVN. MOGA	DS S/D KOT ISE KHAN	D410FL10	11 KV Fakkar Hamu Shah	AMR	OK	31.03.2023	Category 5-UPS				222222	1200/577/1-1-1	4,095	NA	Director/D	
B.11058	West	FARIDKOT	11KV	DS CITY DIVN. MOGA	DS S/D KOT ISE KHAN	L109D435	11 KV Said Mohम्मद	AMR	OK	31.03.2023	AP 3Phase 3Wire				1702	1200/577/1-1-1	1,257	NA	Director/D	
B.11059	West	FARIDKOT	11KV	DS CITY DIVN. MOGA	DS S/D KOT ISE KHAN	D425FL18	11KV BABA KENAR SINGH AP	NON AMR	OK	31.03.2023	AP 3Phase 3Wire				12	900-450/5	0,886	NA	Director/D	
B.11060	West	FARIDKOT	11KV	DS CITY DIVN. MOGA	DS S/D KOT ISE KHAN	D425FL09	11 KV Baba Darshan Singh AP	AMR	OK	31.03.2023	AP 3Phase 3Wire				11111	900-450/5	1,116	NA	Director/D	
B.11061	West	FARIDKOT	11KV	DS CITY DIVN. MOGA	DS S/D KOT ISE KHAN	D425FL11	11 KV BABA NAND SINGH AP	NON AMR	OK	31.03.2023	AP 3Phase 3Wire				1012	900-450/5	1,207	NA	Director/D	
B.11062	West	FARIDKOT	11KV	DS CITY DIVN. MOGA	DS S/D KOT ISE KHAN	D425FL10	11 KV Lohara (AP)	AMR	OK	31.03.2023	AP 3Phase 3Wire				1111111	900-450/5	1,300	NA	Director/D	
B.11063	West	FARIDKOT	11KV	DS CITY DIVN. MOGA	DS S/D KOT ISE KHAN	D425FL03	RAJWALA AP	AMR	OK	31.03.2023	AP 3Phase 3Wire				8227262	900-450/5	1,592	NA	Director/D	
B.11064	West	FARIDKOT	11KV	DS CITY DIVN. MOGA	DS S/D KOT ISE KHAN	D425FL05	KHOSA RANDHIR (Ghal)	AMR	OK	31.03.2023	AP 3Phase 3Wire				7032965	900-450/5	1,986	NA	Director/D	
B.11065	West	FARIDKOT	11KV	DS CITY DIVN. MOGA	DS S/D KOT ISE KHAN	D425FL02	JANER (AUGSAR)	AMR	OK	31.03.2023	AP 3Phase 3Wire				8227262	900-450/5	2,299	NA	Director/D	
B.11066	West	FARIDKOT	11KV	DS CITY DIVN. MOGA	DS S/D KOT ISE KHAN	D425FL06	JANER UPS NEW	AMR	OK	31.03.2023	Category 5-UPS				9534404	900-450/5	2,420	NA	Director/D	
B.11067	West	FARIDKOT	11KV	DS CITY DIVN. MOGA	DS S/D KOT ISE KHAN	D425FL04	WARE AP	AMR	OK	31.03.2023	AP 3Phase 3Wire				7039566	900-450/5	2,485	NA	Director/D	
B.11068	West	FARIDKOT	11KV	DS CITY DIVN. MOGA	DS S/D KOT ISE KHAN	D425FL08	DAMU SHAH	AMR	OK	31.03.2023	Category 5-UPS				6669550	900-450/5	5,217	NA	Director/D	
B.11069	West	FARIDKOT	11KV	DS CITY DIVN. MOGA	DS S/D KOT ISE KHAN	D426FL09	11 KV Kutia AP	AMR	OK	31.03.2023	AP 3Phase 3Wire				48912	900-450/5	1,523	NA	Director/D	
B.11070	West	FARIDKOT	11KV	DS CITY DIVN. MOGA	DS S/D KOT ISE KHAN	D426FL17	11 KV Balkandi 2 AP	AMR	OK	31.03.2023	AP 3Phase 3Wire				1111111111	1200/577/1-1-1	1,741	NA	Director/D	
B.11071	West	FARIDKOT	11KV	DS CITY DIVN. MOGA	DS S/D KOT ISE KHAN	D426FL03	BALKANDI AP	AMR	OK	31.03.2023	AP 3Phase 3Wire				7366678	1200/577/1-1-1	1,790	NA	Director/D	
B.11072	West	FARIDKOT	11KV	DS CITY DIVN. MOGA	DS S/D KOT ISE KHAN	D426FL02	BABA FATEH SINGH AP	AMR	OK	31.03.2023	AP 3Phase 3Wire				7336517	900-450/5	1,790	NA	Director/D	
B.11073	West	FARIDKOT	11KV	DS CITY DIVN. MOGA	DS S/D KOT ISE KHAN	D426FL01	KHOSA KOTLA (Gurusajap)	NON AMR	OK	31.03.2023	AP 3Phase 3Wire				8227264	900-450/5	1,838	NA	Director/D	
B.11074	West	FARIDKOT	11KV	DS CITY DIVN. MOGA	DS S/D KOT ISE KHAN	D426FL15	Sahib Singh AP	AMR	OK	31.03.2023	AP 3Phase 3Wire				1111141	900-450/5	1,886	NA	Director/D	
B.11075	West	FARIDKOT	11KV	DS CITY DIVN. MOGA	DS S/D KOT ISE KHAN	D426FL14	Khosa Jindal AP	AMR	OK	31.03.2023	AP 3Phase 3Wire				2659	1200/577/1-1-1	1,428	NA	Director/D	
B.11076	West	FARIDKOT	11KV	DS CITY DIVN. MOGA	DS S/D KOT ISE KHAN	D426FL05	RANG SINGH AP	AMR	OK	31.03.2023	AP 3Phase 3Wire				9534358	1200/577/1-1-1	2,295	NA	Director/D	
B.11077	West	FARIDKOT	11KV	DS CITY DIVN. MOGA	DS S/D KOT ISE KHAN	D426FL06	KHOSA KOTLA	AMR	OK	31.03.2023	Category 1				7336511	900-450/5	3,655	NA	Director/D	
B.11078	West	FARIDKOT	11KV	DS CITY DIVN. MOGA	DS S/D KOT ISE KHAN	D426FL04	KHOSA RANDHIR (Randlia)	AMR	OK	31.03.2023	Category 5-UPS				7336517	1200/577/1-1-1	6,831	NA	Director/D	
B.11079	West	FARIDKOT	11KV	DS CITY DIVN. MOGA	DS S/D KOT ISE KHAN	D426FL16	11 KV Dattewala UPS	AMR	OK	31.03.2023	Category 5-UPS				4012	1200/577/1-1-1	6,930	NA	Director/D	
B.11080	West	FARIDKOT	11KV	DS CITY DIVN. MOGA	DS S/D KOT ISE KHAN	D411FL02	GAGRA (Janajap)	AMR	OK	31.03.2023	AP 3Phase 3Wire				9140952	1200/577/1-1-1	0,908	NA	Director/D	
B.11081	West	FARIDKOT	11KV	DS CITY DIVN. MOGA	DS S/D KOT ISE KHAN	D411FL01	RAJWALA (Gadoli) AP	AMR	OK	31.03.2023	AP 3Phase 3Wire				9140951	1200/577/1-1-1	1,034	NA	Director/D	
B.11082	West	FARIDKOT	11KV	DS CITY DIVN. MOGA	DS S/D KOT ISE KHAN	D411FL07	GEHLWALA (SHADIWALA) AP	AMR	OK	31.03.2023	AP 3Phase 3Wire				10282881	1200/577/1-1-1	1,492	NA	Director/D	
B.11083	West	FARIDKOT	11KV	DS CITY DIVN. MOGA	DS S/D KOT ISE KHAN	D411FL17	Khosa Branch AP	AMR	OK	31.03.2023	AP 3Phase 3Wire				11111111	1200/577/1-1-1	1,664	NA	Director/D	
B.11084	West	FARIDKOT	11KV	DS CITY DIVN. MOGA	DS S/D KOT ISE KHAN	D411FL10	Daleulewa (KADAR WALA) AP	AMR	OK	31.03.2023	AP 3Phase 3Wire				5437728	1200/577/1-1-1	1,721	NA	Director/D	
B.11085	West	FARIDKOT	11KV	DS CITY DIVN. MOGA	DS S/D KOT ISE KHAN	D411FL12	LONGWIND-AP	AMR	OK	31.03.2023	AP 3Phase 3Wire				6669385	1200/577/1-1-1	1,888	NA	Director/D	
B.11086	West	FARIDKOT	11KV	DS CITY DIVN. MOGA	DS S/D KOT ISE KHAN	D421FL05	MAHJAN AP	AMR	OK	31.03.2023	AP 3Phase 3Wire				9140955	1200/577/1-1-1	1,207	NA	Director/D	
B.11087	West	FARIDKOT	11KV	DS CITY DIVN. MOGA	DS S/D KOT ISE KHAN	D421FL09	DATTETWAL AP	AMR	OK	31.03.2023	AP 3Phase 3Wire				8232371	1200/577/1-1-1	1,052	NA	Director/D	
B.11088	West	FARIDKOT	11KV	DS CITY DIVN. MOGA	DS S/D KOT ISE KHAN	D411FL16	RANDIALA AP	AMR	OK	31.03.2023	AP 3Phase 3Wire				11117142	1200/577/1-1-1	2,075	NA	Director/D	
B.11089	West	FARIDKOT	11KV	DS CITY DIVN. MOGA	DS S/D KOT ISE KHAN	D411FL03	MEHAL AP	NON AMR	OK	31.03.2023	AP 3Phase 3Wire				8232372	1200/577/1-1-1	2,110	NA	Director/D	
B.11090	West	FARIDKOT	11KV	DS CITY DIVN. MOGA	DS S/D KOT ISE KHAN	D411FL15	Baba Daan Singh AP	AMR	OK	31.03.2023	AP 3Phase 3Wire				1111111	1200/577/1-1-1	2,365	NA	Director/D	
B.11091	West	FARIDKOT	11KV	DS CITY DIVN. MOGA	DS S/D KOT ISE KHAN	D411FL08	DHIR FARM (Janer) AP	AMR	OK											

S.No	Zone	Circle	Voltage Level (kVA)	Division (kVA)	Sub-Division (kVA)	Feeder ID	Feeder Name	Feeder Metering Status (Metred/unmetred/AMR/AMI)	Status of Meter (Functional/Non-Functional)	Metering Date Date of last actual meter reading/ communication	Feeder Type (Agr/ Industrial/Mixed)	Status of Communication			Period from 01.04.2021 to 31.03.2022				Sales
												% Data received through automatically if feeder AMR/AMI	Number of hours when meter was unable to communicate in overall	Total Number of hours in the period	Meter S.No	CT/P ratio	Import (kU)	Export (kU)	
B.11125	West	FARIDKOT	11KV	DS CITY DIVN. MOGA	DS S/U S/D MOGA	D430FL03	FOCAL POINT	AMR	OK	31.03.2023	Category 2				9568212	1200/577/1-1-1	10.375	NA	Director/D
B.11126	West	FARIDKOT	11KV	DS CITY DIVN. MOGA	DS S/U S/D MOGA	D430FL11	PREM NAGAR	AMR	OK	31.03.2023	Category 1				9568149	1200/577/1-1-1	10.558	NA	Director/D
B.11127	West	FARIDKOT	11KV	DS CITY DIVN. MOGA	DS SOUTH S/D MOGA	D430FL12	MOGA-1	AMR	OK	31.03.2023	Category 1				9568288	1200-600/5	8.953	NA	Director/D
B.11128	West	FARIDKOT	11KV	DS CITY DIVN. MOGA	DS SOUTH S/D MOGA	D430FL06	MOGA-2	AMR	OK	31.03.2023	Category 1				9568291	1200-600/5	12.513	NA	Director/D
B.11129	West	FARIDKOT	11KV	DS CITY DIVN. MOGA	DS SOUTH S/D MOGA	8401FL25	Jawahar Nagar	AMR	OK	31.03.2023	Category 1				11111	1200-600/5	14.608	NA	Director/D
B.11130	West	FARIDKOT	11KV	DS CITY DIVN. MOGA	DS SOUTH S/D MOGA	8401FL05	Mallan Shah AP	AMR	OK	31.03.2023	AP 3Phase 3Wire				11117045	1200-600/5	2.565	NA	Director/D
B.11131	West	FARIDKOT	11KV	DS CITY DIVN. MOGA	DS SOUTH S/D MOGA	8401FL04	CITY MOGA	NON AMR	OK	31.03.2023	Category 1				4186055	1200-600/5	16.160	NA	Director/D
B.11132	West	FARIDKOT	11KV	DS CITY DIVN. MOGA	DS SOUTH S/D MOGA	8401FL20	VIDANT NAGAR	AMR	OK	31.03.2023	Category 1				11052061	1200-600/5	17.022	NA	Director/D
B.11133	West	FARIDKOT	11KV	DS DIVN. BAGHAPURANA	DS CITY S/D BAGHAPURANA	C406FL14	11 KV MOGA ROAD CAT-02	NON AMR	OK	31.03.2023	Category 2				5390320	1200-600/5	1.331	NA	Director/D
B.11134	West	FARIDKOT	11KV	DS DIVN. BAGHAPURANA	DS CITY S/D BAGHAPURANA	C406FL16	11 KV JAI SINGH WALA	AMR	OK	31.03.2023	AP 3Phase 3Wire				111111	1200-600/5	1.942	NA	Director/D
B.11135	West	FARIDKOT	11KV	DS DIVN. BAGHAPURANA	DS CITY S/D BAGHAPURANA	C406FL03	11 BHEKHA -R (220 KV BPA)	AMR	OK	31.03.2023	AP 3Phase 3Wire				8222924	1200-600/5	2.088	NA	Director/D
B.11136	West	FARIDKOT	11KV	DS DIVN. BAGHAPURANA	DS CITY S/D BAGHAPURANA	C406FL04	11 KV CHOTIAN RURAL	NON AMR	OK	31.03.2023	AP 3Phase 3Wire				8222632	1200-600/5	2.185	NA	Director/D
B.11137	West	FARIDKOT	11KV	DS DIVN. BAGHAPURANA	DS CITY S/D BAGHAPURANA	C406FL17	11KV Mandir	AMR	OK	31.03.2023	AP 3Phase 3Wire				35675	1200-600/5	3.326	NA	Director/D
B.11138	West	FARIDKOT	11KV	DS DIVN. BAGHAPURANA	DS CITY S/D BAGHAPURANA	C406FL05	11 KV NIGAHIA RURAL	AMR	OK	31.03.2023	AP 3Phase 3Wire				8222399	1200-600/5	3.553	NA	Director/D
B.11139	West	FARIDKOT	11KV	DS DIVN. BAGHAPURANA	DS CITY S/D BAGHAPURANA	C406FL13	11 KV RAJANA RURAL	AMR	OK	31.03.2023	AP 3Phase 3Wire				2067979	1200-600/5	3.611	NA	Director/D
B.11140	West	FARIDKOT	11KV	DS DIVN. BAGHAPURANA	DS CITY S/D BAGHAPURANA	C406FL09	11 KV LANGEANA RURAL	AMR	OK	31.03.2023	AP 3Phase 3Wire				4263572	1200-600/5	3.613	NA	Director/D
B.11141	West	FARIDKOT	11KV	DS DIVN. BAGHAPURANA	DS CITY S/D BAGHAPURANA	C406FL02	11 KV GILL RURAL	AMR	OK	31.03.2023	AP 3Phase 3Wire				9141037	1200-600/5	4.614	NA	Director/D
B.11142	West	FARIDKOT	11KV	DS DIVN. BAGHAPURANA	DS CITY S/D BAGHAPURANA	C406FL11	11 KV GHOLIA RURAL	AMR	OK	31.03.2023	AP 3Phase 3Wire				8222495	1200-600/5	4.943	NA	Director/D
B.11143	West	FARIDKOT	11KV	DS DIVN. BAGHAPURANA	DS CITY S/D BAGHAPURANA	C406FL10	11 KV CHANNUNWALA RURAL	AMR	OK	31.03.2023	AP 3Phase 3Wire				8222635	1200-600/5	5.208	NA	Director/D
B.11144	West	FARIDKOT	11KV	DS DIVN. BAGHAPURANA	DS CITY S/D BAGHAPURANA	C406FL20	11KV KALEKE UPS	AMR	OK	31.03.2023	Category 5-UPS				11111111	1200/577/1-1-1	5.453	NA	Director/D
B.11145	West	FARIDKOT	11KV	DS DIVN. BAGHAPURANA	DS CITY S/D BAGHAPURANA	C406FL01	11 KV GILL UPS	AMR	OK	31.03.2023	Category 5-UPS				2057581	1200-600/5	6.661	NA	Director/D
B.11146	West	FARIDKOT	11KV	DS DIVN. BAGHAPURANA	DS CITY S/D BAGHAPURANA	C406FL06	11 KV ALAMWALA-UPS	AMR	OK	31.03.2023	Category 5-UPS				8222923	1200-600/5	7.947	NA	Director/D
B.11147	West	FARIDKOT	11KV	DS DIVN. BAGHAPURANA	DS CITY S/D BAGHAPURANA	C406FL19	11 KV KOTKAPURA ROAD	AMR	OK	31.03.2023	Category 1				11111111	1200/577/1-1-1	9.139	NA	Director/D
B.11148	West	FARIDKOT	11KV	DS DIVN. BAGHAPURANA	DS CITY S/D BAGHAPURANA	C406FL18	11 KV INDUSTRY	AMR	OK	31.03.2023	Category 2				9141037	1200/577/1-1-1	11.038	NA	Director/D
B.11149	West	FARIDKOT	11KV	DS DIVN. BAGHAPURANA	DS CITY S/D BAGHAPURANA	C406FL12	11 KV GURJUDWARA RD. CAT-01	AMR	OK	31.03.2023	Category 1				11116798	1200-600/5	11.398	NA	Director/D
B.11150	West	FARIDKOT	11KV	DS DIVN. BAGHAPURANA	DS CITY S/D BAGHAPURANA	C406FL15	11 KV MUKHI ROAD CAT-02	AMR	OK	31.03.2023	Category 1				7336467	1200-600/5	13.284	NA	Director/D
B.11151	West	FARIDKOT	11KV	DS DIVN. BAGHAPURANA	DS CITY S/D BAGHAPURANA	C406FL07	11 KV BAGHAPURANA URBAN CAT-01	NON AMR	OK	31.03.2023	Category 1				8222399	1200/577/1-1-1	13.538	NA	Director/D
B.11152	West	FARIDKOT	11KV	DS DIVN. BAGHAPURANA	DS CITY S/D BAGHAPURANA	8401FL19	11 KV DHAKI SAHIB	AMR	OK	31.03.2023	AP 3Phase 3Wire				11117040	1200-600/5	2.154	NA	Director/D
B.11153	West	FARIDKOT	11KV	DS DIVN. BAGHAPURANA	DS CITY S/D BAGHAPURANA	8401FL14	11 KV MOTHAN WALI -RURAL	NON AMR	OK	31.03.2023	AP 3Phase 3Wire				8223089	1200-600/5	2.420	NA	Director/D
B.11154	West	FARIDKOT	11KV	DS DIVN. BAGHAPURANA	DS CITY S/D BAGHAPURANA	8401FL11	11 KV CHAND NAWAN R	NON AMR	OK	31.03.2023	AP 3Phase 3Wire				8223090	1200-600/5	2.453	NA	Director/D
B.11155	West	FARIDKOT	11KV	DS DIVN. BAGHAPURANA	DS CITY S/D BAGHAPURANA	8401FL22	11 KV BUKKAN WALA-R	AMR	OK	31.03.2023	AP 3Phase 3Wire				6781922	1200-800/5	2.783	NA	Director/D
B.11156	West	FARIDKOT	11KV	DS DIVN. BAGHAPURANA	DS CITY S/D BAGHAPURANA	8401FL13	11 KV CHAND PURANA	AMR	OK	31.03.2023	AP 3Phase 3Wire				8223113	1200-600/5	3.211	NA	Director/D
B.11157	West	FARIDKOT	11KV	DS DIVN. BAGHAPURANA	DS CITY S/D BAGHAPURANA	8401FL08	11 KV SINGHANWALA-R	AMR	OK	31.03.2023	AP 3Phase 3Wire				11116732	1200-600/5	4.120	NA	Director/D
B.11158	West	FARIDKOT	11KV	DS DIVN. BAGHAPURANA	DS CITY S/D BAGHAPURANA	8401FL10	11 KV SINGHANWALA-UPS	AMR	OK	31.03.2023	Category 5-UPS				11116797	1200-600/5	12.426	NA	Director/D
B.11159	West	FARIDKOT	11KV	DS DIVN. BAGHAPURANA	DS CITY S/D BAGHAPURANA	D417FL10	11 KV RAJANA-R 66KV MARI MUSTFA	AMR	OK	31.03.2023	AP 3Phase 3Wire				2066984	1200/577/1-1-1	2.398	NA	Director/D
B.11160	West	FARIDKOT	11KV	DS DIVN. BAGHAPURANA	DS CITY S/D BAGHAPURANA	D417FL02	11 KV KOTLA MEHAR SINGH RURAL	AMR	OK	31.03.2023	AP 3Phase 3Wire				8222493	1200/577/1-1-1	3.058	NA	Director/D
B.11161	West	FARIDKOT	11KV	DS DIVN. BAGHAPURANA	DS CITY S/D BAGHAPURANA	D417FL25	11KV AP REED CHARIK	NON AMR	OK	31.03.2023	AP 3Phase 3Wire				15163725	900-450/577/1-1-1	3.510	NA	Director/D
B.11162	West	FARIDKOT	11KV	DS DIVN. BAGHAPURANA	DS CITY S/D BAGHAPURANA	FL04D413	11 KV KALE-RURAL	AMR	OK	31.03.2023	AP 3Phase 3Wire				8221017	900-450/5	2.134	NA	Director/D
B.11163	West	FARIDKOT	11KV	DS DIVN. BAGHAPURANA	DS CITY S/D BAGHAPURANA	D413FL21	11 KV Kale ke -2 (AP)	AMR	OK	31.03.2023	AP 3Phase 3Wire				15196560	900-450/577/1-1-1	2.202	NA	Director/D
B.11164	West	FARIDKOT	11KV	DS DIVN. BAGHAPURANA	DS CITY S/D BAGHAPURANA	D429FL01	11 KV GAJIANWALA-U-CAT-01	AMR	OK	31.03.2023	Category 1				9154038	900-450/577/1-1-1	0.962	NA	Director/D
B.11165	West	FARIDKOT	11KV	DS DIVN. BAGHAPURANA	DS CITY S/D BAGHAPURANA	D429FL12	11 KV Shaheed Bhagat Singh (AP)	NON AMR	OK	31.03.2023	AP 3Phase 3Wire				37134	900-450/577/1-1-1	1.094	NA	Director/D
B.11166	West	FARIDKOT	11KV	DS DIVN. BAGHAPURANA	DS CITY S/D BAGHAPURANA	D429FL10	SANT PREM SINGH	AMR	OK	31.03.2023	AP 3Phase 3Wire				37199	900-450/577/1-1-1	1.359	NA	Director/D
B.11167	West	FARIDKOT	11KV	DS DIVN. BAGHAPURANA	DS CITY S/D BAGHAPURANA	D429FL11	11KV SANT TARA SINGH	AMR	OK	31.03.2023	AP 3Phase 3Wire				37215	900-450/577/1-1-1	1.406	NA	Director/D
B.11168	West	FARIDKOT	11KV	DS DIVN. BAGHAPURANA	DS CITY S/D BAGHAPURANA	D429FL08	11KV LANGIANA NAWAN 66KV G/W	AMR	OK	31.03.2023	AP 3Phase 3Wire				11111111	900-450/577/1-1-1	1.549	NA	Director/D
B.11169	West	FARIDKOT	11KV	DS DIVN. BAGHAPURANA	DS CITY S/D BAGHAPURANA	D429FT03	11 KV PANTHANGARH RURAL	AMR	OK	31.03.2023	AP 3Phase 3Wire				7336690	900-450/577/1-1-1	1.655	NA	Director/D
B.11170	West	FARIDKOT	11KV	DS DIVN. BAGHAPURANA	DS CITY S/D BAGHAPURANA	D429FT05	11 KV GURUSAR RURAL	AMR	OK	31.03.2023	AP 3Phase 3Wire				7042869	900-450/577/1-1-1	1.908	NA	Director/D
B.11171	West	FARIDKOT	11KV	DS DIVN. BAGHAPURANA	DS CITY S/D BAGHAPURANA	D429FL04	11 KV BHEKHE ROAD-RURAL	AMR	OK	31.03.2023	AP 3Phase 3Wire				7336469	900-450/577/1-1-1	1.909	NA	Director/D
B.11172	West	FARIDKOT	11KV	DS DIVN. BAGHAPURANA	DS CITY S/D BAGHAPURANA	D429FT06	11 KV LANGANA-UPS	AMR	OK	31.03.2023	Category 5-UPS				900-450/577/1-1-1	3.565	NA	Director/D	
B.11173	West	FARIDKOT	11KV	DS DIVN. BAGHAPURANA	DS CITY S/D BAGHAPURANA	C41FT05	11 KV KOTHE SINGHU WALA-R	AMR	OK	31.03.2023	AP 3Phase 3Wire				7336733	1200-600/5	3.655	NA	Director/D
B.11174	West	FARIDKOT	11KV	DS DIVN. BAGHAPURANA	DS CITY S/D BAGHAPURANA	FL04D405	11 KV BABA FARID CAT-1	AMR	OK	31.03.2023	Category 1				11111	900-450/577/1-1-1	0.942	NA	Director/D
B.11175	West	FARIDKOT	11KV	DS DIVN. BAGHAPURANA	DS CITY S/D BAGHAPURANA	D405FL13	11 KV NATHUWALA RURAL	AMR	OK	31.03.2023	AP 3Phase 3Wire				11111	900-450/577/1-1-1	1.677	NA	Director/D
B.11176	West	FARIDKOT	11KV	DS DIVN. BAGHAPURANA	DS CITY S/D BAGHAPURANA	D405FL11	11 KV BABA PARTAP SINGH	AMR	OK	31.03.2023	AP 3Phase 3Wire				2068743	900-450/577/1-1-1	1.743	NA	Director/D
B.11177	West	FARIDKOT	11KV	DS DIVN. BAGHAPURANA	DS CITY S/D BAGHAPURANA	D405FL16	11 KV BIR BHAIAN SINGH	AMR	OK	31.03.2023	AP 3Phase 3Wire				8222754	900-450/577/1-1-1	1.795	NA	Director/D
B.11178	West	FARIDKOT	11KV	DS DIVN. BAGHAPURANA	DS CITY S/D BAGHAPURANA	D405FL12	11 KV BHEKHA RURAL	AMR	OK	31.03.2023	AP 3Phase 3Wire				8222363	900-450/577/1-1-1	2.074	NA	Director/D
B.11179	West	FARIDKOT	11KV	DS DIVN. BAGHAPURANA	DS CITY S/D BAGHAPURANA	D405FL12	11 KV LANGIANA -A AP (66KV N/W)	AMR	OK	31.03.2023	AP 3Phase 3Wire				9154167	900-450/577/1-1-1	2.349	NA	Director/D
B.11180	West	FARIDKOT	11KV	DS DIVN. BAGHAPURANA	DS CITY S/D BAGHAPURANA	D405FL02	11 KV BABA BIR SINGH UPS	AMR	OK	31.03.2023	Category 5-UPS				11111	900-450/577/1-1-1	3.478	NA	Director/D
B.11181	West	FARIDKOT	11KV	DS DIVN. BAGHAPURANA	DS CITY S/D BAGHAPURANA	D405FL09	11 KV BMS NATHUWALA-CAT-01	AMR	OK	31.03.2023	Category 1				11111	900-450/577/1-1-1	4.665	NA	Director/D
B.11182	West	FARIDKOT	11KV	DS DIVN. BAGHAPURANA	DS CITY S/D BAGHAPURANA	D429FL06	11 KV GURJUKI RURAL	AMR	OK	31.03.2023	AP 3Phase 3Wire				2065796	1200-600/5	2.199	NA	Director/D
B.11183	West	FARIDKOT	11KV	DS DIVN. BAGHAPURANA	DS CITY S/D BAGHAPURANA	D429FL08	11 KV JAI OTAS	AMR	OK	31.03.2023	Category 5-UPS				Not Installed	100-450/5	0.164	NA	Director/D
B.11184	West	FARIDKOT	11KV	DS DIVN. BAGHAPURANA	DS S/D BILASPUR	D405FL11	MACHIKE-3	AMR	OK	31.03.2023	AP 3Phase 3Wire				11111111	900-450/5	1.058	NA	Director/D
B.11185	West	FARIDKOT	11KV	DS DIVN. BAGHAPURANA	S/D BILASPUR	8405FL15	Himmapura-3 Rural	AMR	OK	31.03.2023	AP 3Phase 3Wire				4312	900-450/5	1.080	NA	Director/D
B.11186	West	FARIDKOT	11KV	DS DIVN. BAGHAPURANA	S/D BILASPUR	8405FL18	MALLO SHAHEED AP	AMR	OK	31.03.2023	AP 3Phase 3Wire				11111111	900-450/5	1.251	NA	Director/D
B.11187	West	FARIDKOT	11																

S.No	Zone	Circle	Voltage Level (kVA)	Division (kVA)	Sub-Division (kVA)	Feeder ID	Feeder Name	Feeder Metering Status (Metred/unmetred/AMR/AM)	Status of Meter (Functional/Non-Functional)	Metering Date	Date of last actual meter reading/communication	Feeder Type (Agr/Industrial/Mixed)	Status of Communication			Period from 01.04.2021 to 31.03.2022		Sales	Remarks (Source of data)	
													% Data received through automatically if feeder AMR/AM	Number of hours when meter was unable to communicate in overall	Total Number of hours in the period	Meter S.No	CT/PT ratio			Import (kU)
B.11222	West	FARIDKOT	11KV	DS DIVN. BAGHAPURAN	S/D BILASPUR	D04BFL10	11 KV BILASPUR UPS	AMR	OK	31.03.2023		Category 5-UPS				2047124	1200-600/5	12.411	NA	Director/D
B.11223	West	FARIDKOT	11KV	DS DIVN. BAGHAPURAN	S/D PATTO HIRA SINGH	C007FL12	11 KV BABA JUHAR SINGH WALA RUR	AMR	OK	31.03.2023		AP 3Phase 3Wire				1319054	1200/577/1-1-1	2.565	NA	Director/D
B.11224	West	FARIDKOT	11KV	DS DIVN. BAGHAPURAN	S/D PATTO HIRA SINGH	C007FL09	11 KV RAUNTA-B-RURAL. 132KV GRID	AMR	OK	31.03.2023		AP 3Phase 3Wire				4187142	1200/577/1-1-1	3.341	NA	Director/D
B.11225	West	FARIDKOT	11KV	DS DIVN. BAGHAPURAN	S/D PATTO HIRA SINGH	B029FL17	11KV Sadoke (220KV HIMMATPURA)	AMR	OK	31.03.2023		AP 3Phase 3Wire				1197	900-450/5	2.128	NA	Director/D
B.11226	West	FARIDKOT	11KV	DS DIVN. BAGHAPURAN	S/D PATTO HIRA SINGH	B045FL08	11KV PAKA SAHIB(220 Nimmattura)	AMR	OK	31.03.2023		AP 3Phase 3Wire				11117029	900-450/577/1-1-1	2.774	NA	Director/D
B.11227	West	FARIDKOT	11KV	DS DIVN. BAGHAPURAN	S/D PATTO HIRA SINGH	D047FL11	11 KV KISHANGARH-R	AMR	OK	31.03.2023		AP 3Phase 3Wire				5343315	Not installed	1.501	NA	Director/D
B.11228	West	FARIDKOT	11KV	DS DIVN. BAGHAPURAN	S/D PATTO HIRA SINGH	D047FL17	11 KV Jorwar Singh	AMR	OK	31.03.2023		AP 3Phase 3Wire				12479259	Not installed	1.520	NA	Director/D
B.11229	West	FARIDKOT	11KV	DS DIVN. BAGHAPURAN	S/D PATTO HIRA SINGH	D047FL23	11KV PUNJAB	AMR	OK	31.03.2023		AP 3Phase 3Wire				111111111	Not installed	1.601	NA	Director/D
B.11230	West	FARIDKOT	11KV	DS DIVN. BAGHAPURAN	S/D PATTO HIRA SINGH	D047FL09	11 KV SAHI WALI(R)	AMR	OK	31.03.2023		AP 3Phase 3Wire				8222889	Not installed	1.991	NA	Director/D
B.11231	West	FARIDKOT	11KV	DS DIVN. BAGHAPURAN	S/D PATTO HIRA SINGH	D047FL12	11 KV LOHGARH SAHIB	AMR	OK	31.03.2023		AP 3Phase 3Wire				2067433	Not installed	2.045	NA	Director/D
B.11232	West	FARIDKOT	11KV	DS DIVN. BAGHAPURAN	S/D PATTO HIRA SINGH	D047FL08	11 KV GAZIANA RURAL	AMR	OK	31.03.2023		AP 3Phase 3Wire				8222890	Not installed	2.208	NA	Director/D
B.11233	West	FARIDKOT	11KV	DS DIVN. BAGHAPURAN	S/D PATTO HIRA SINGH	D047FL21	11KV SHAHD BHAGAT SINGH	AMR	OK	31.03.2023		AP 3Phase 3Wire				11111111	Not installed	2.211	NA	Director/D
B.11234	West	FARIDKOT	11KV	DS DIVN. BAGHAPURAN	S/D PATTO HIRA SINGH	D047FL07	11 KV RAUNTA RURAL-A (66KV DINA	AMR	OK	31.03.2023		AP 3Phase 3Wire				8222887	Not installed	2.264	NA	Director/D
B.11235	West	FARIDKOT	11KV	DS DIVN. BAGHAPURAN	S/D PATTO HIRA SINGH	D047FL13	11 KV BABA AMRIK SINGH	AMR	OK	31.03.2023		AP 3Phase 3Wire				37120	Not installed	2.330	NA	Director/D
B.11236	West	FARIDKOT	11KV	DS DIVN. BAGHAPURAN	S/D PATTO HIRA SINGH	D047FL16	11 KV CHARAN KAMAL RURAL	AMR	OK	31.03.2023		AP 3Phase 3Wire				12479725	Not installed	2.385	NA	Director/D
B.11237	West	FARIDKOT	11KV	DS DIVN. BAGHAPURAN	S/D PATTO HIRA SINGH	D047FL19	11 KV BABA NANNAN RURAL	AMR	OK	31.03.2023		AP 3Phase 3Wire				12479704	Not installed	2.494	NA	Director/D
B.11238	West	FARIDKOT	11KV	DS DIVN. BAGHAPURAN	S/D PATTO HIRA SINGH	D047FL18	11 KV KHA (66KV GRID DINA SAHIB	AMR	OK	31.03.2023		AP 3Phase 3Wire				12479716	Not installed	2.515	NA	Director/D
B.11239	West	FARIDKOT	11KV	DS DIVN. BAGHAPURAN	S/D PATTO HIRA SINGH	D047FL14	11 KV HAKAM PURI	AMR	OK	31.03.2023		AP 3Phase 3Wire				43160	Not installed	2.699	NA	Director/D
B.11240	West	FARIDKOT	11KV	DS DIVN. BAGHAPURAN	S/D PATTO HIRA SINGH	D047FL04	11 KV Sadoke (66KV DINA SAHIB)	AMR	OK	31.03.2023		AP 3Phase 3Wire				8222886	Not installed	2.967	NA	Director/D
B.11241	West	FARIDKOT	11KV	DS DIVN. BAGHAPURAN	S/D PATTO HIRA SINGH	D047FL03	11 KV DINA SAHIB- RURAL(Diha Gr	AMR	OK	31.03.2023		AP 3Phase 3Wire				8223044	Not installed	3.209	NA	Director/D
B.11242	West	FARIDKOT	11KV	DS DIVN. BAGHAPURAN	S/D PATTO HIRA SINGH	D047FL02	11KV ZAFAT NAMA- UPS	AMR	OK	31.03.2023		Category 5-UPS				2067263	Not installed	3.172	NA	Director/D
B.11243	West	FARIDKOT	11KV	DS DIVN. BAGHAPURAN	S/D PATTO HIRA SINGH	D047FL10	11 KV BURI HAMIRA UPS	AMR	OK	31.03.2023		Category 5-UPS				7042953	Not installed	13.967	NA	Director/D
B.11244	West	FARIDKOT	11KV	DS DIVN. BAGHAPURAN	S/D PATTO HIRA SINGH	D046FL25	11KV MAL BHAGO FEEDER	NON AMR	OK	31.03.2023		Category 5-UPS				1613	900-450/577/1-1-1	1.689	NA	Director/D
B.11245	West	FARIDKOT	11KV	DS DIVN. BAGHAPURAN	S/D PATTO HIRA SINGH	D046FL02	11 KV DIDAR S WALA-RURAL	AMR	OK	31.03.2023		AP 3Phase 3Wire				15194660	1200/577/1-1-1	1.847	NA	Director/D
B.11246	West	FARIDKOT	11KV	DS DIVN. BAGHAPURAN	S/D PATTO HIRA SINGH	D046FL06	11 KV JAWAHAR SINGH WALAINANGAL	AMR	OK	31.03.2023		AP 3Phase 3Wire				8223041	900-450/577/1-1-1	1.870	NA	Director/D
B.11247	West	FARIDKOT	11KV	DS DIVN. BAGHAPURAN	S/D PATTO HIRA SINGH	D046FL29	11KV GAHPALA	AMR	OK	31.03.2023		AP 3Phase 3Wire				1571	1200/577/1-1-1	1.888	NA	Director/D
B.11248	West	FARIDKOT	11KV	DS DIVN. BAGHAPURAN	S/D PATTO HIRA SINGH	D046FL23	11 KV KHOTE RURAL	AMR	OK	31.03.2023		AP 3Phase 3Wire				1568	1200/577/1-1-1	2.119	NA	Director/D
B.11249	West	FARIDKOT	11KV	DS DIVN. BAGHAPURAN	S/D PATTO HIRA SINGH	D046FL30	Nangal AP	AMR	OK	31.03.2023		AP 3Phase 3Wire				11117266	1200/577/1-1-1	2.345	NA	Director/D
B.11250	West	FARIDKOT	11KV	DS DIVN. BAGHAPURAN	S/D PATTO HIRA SINGH	D046FL32	KHULI WALA	NON AMR	OK	31.03.2023		AP 3Phase 3Wire				11111111	1200/577/1-1-1	2.330	NA	Director/D
B.11251	West	FARIDKOT	11KV	DS DIVN. BAGHAPURAN	S/D PATTO HIRA SINGH	D046FL11	11 KV PAKA SAHIB-RURAL 66KV PHS	AMR	OK	31.03.2023		AP 3Phase 3Wire				15194660	900-450/577/1-1-1	2.552	NA	Director/D
B.11252	West	FARIDKOT	11KV	DS DIVN. BAGHAPURAN	S/D PATTO HIRA SINGH	D046FL28	11 KV VIVEK ASHRAM	AMR	OK	31.03.2023		AP 3Phase 3Wire				1687	1200/577/1-1-1	2.613	NA	Director/D
B.11253	West	FARIDKOT	11KV	DS DIVN. BAGHAPURAN	S/D PATTO HIRA SINGH	D046FL08	11 KV MADHE KE	AMR	OK	31.03.2023		AP 3Phase 3Wire				8223328	1200/577/1-1-1	2.628	NA	Director/D
B.11254	West	FARIDKOT	11KV	DS DIVN. BAGHAPURAN	S/D PATTO HIRA SINGH	D046FL19	11KV BABA FATEH SINGH WALA RURAL	AMR	OK	31.03.2023		AP 3Phase 3Wire				8223327	900-450/577/1-1-1	2.634	NA	Director/D
B.11255	West	FARIDKOT	11KV	DS DIVN. BAGHAPURAN	S/D PATTO HIRA SINGH	D046FL26	11KV Sadoke (66KV PATTO HIRA SI	AMR	OK	31.03.2023		AP 3Phase 3Wire				1582	1200/577/1-1-1	2.648	NA	Director/D
B.11256	West	FARIDKOT	11KV	DS DIVN. BAGHAPURAN	S/D PATTO HIRA SINGH	D046FL27	11 KV KHA (66KV Grid PATTO HIRA	AMR	OK	31.03.2023		AP 3Phase 3Wire				11117325	1200/577/1-1-1	2.731	NA	Director/D
B.11257	West	FARIDKOT	11KV	DS DIVN. BAGHAPURAN	S/D PATTO HIRA SINGH	D046FL13	11 KV DHUKROT-B-RURAL	AMR	OK	31.03.2023		AP 3Phase 3Wire				8222489	1200/577/1-1-1	2.740	NA	Director/D
B.11258	West	FARIDKOT	11KV	DS DIVN. BAGHAPURAN	S/D PATTO HIRA SINGH	D046FL24	Tala Wali	AMR	OK	31.03.2023		AP 3Phase 3Wire				11117289	1200/577/1-1-1	2.875	NA	Director/D
B.11259	West	FARIDKOT	11KV	DS DIVN. BAGHAPURAN	S/D PATTO HIRA SINGH	D046FL01	11 KV DINA SAHIB 66KV GRD PHS	AMR	OK	31.03.2023		AP 3Phase 3Wire				8223330	900-450/577/1-1-1	2.878	NA	Director/D
B.11260	West	FARIDKOT	11KV	DS DIVN. BAGHAPURAN	S/D PATTO HIRA SINGH	D046FL14	11 KV NANO MAI RURAL	NON AMR	OK	31.03.2023		AP 3Phase 3Wire				8222490	1200/577/1-1-1	3.029	NA	Director/D
B.11261	West	FARIDKOT	11KV	DS DIVN. BAGHAPURAN	S/D PATTO HIRA SINGH	D046FL18	11 KV RANSHI KHURD	AMR	OK	31.03.2023		AP 3Phase 3Wire				11111	1200/577/1-1-1	3.280	NA	Director/D
B.11262	West	FARIDKOT	11KV	DS DIVN. BAGHAPURAN	S/D PATTO HIRA SINGH	D046FL12	11 KV DHUKROT RURAL	AMR	OK	31.03.2023		AP 3Phase 3Wire				8223329	1200/577/1-1-1	3.367	NA	Director/D
B.11263	West	FARIDKOT	11KV	DS DIVN. BAGHAPURAN	S/D PATTO HIRA SINGH	D046FL33	11KV MANGAL UPS	AMR	OK	31.03.2023		Category 5-UPS				1004847	1200/577/1-1-1	3.147	NA	Director/D
B.11264	West	FARIDKOT	11KV	DS DIVN. BAGHAPURAN	S/D PATTO HIRA SINGH	D046FL07	11KV NETA SINGH WALA CAT-01	AMR	OK	31.03.2023		Category 1				4387879	900-450/577/1-1-1	3.670	NA	Director/D
B.11265	West	FARIDKOT	11KV	DS DIVN. BAGHAPURAN	S/D PATTO HIRA SINGH	D046FL22	11KV PATTO HAIR SINGH UPS	AMR	OK	31.03.2023		Category 1				15194668	1200/577/1-1-1	3.994	NA	Director/D
B.11266	West	FARIDKOT	11KV	DS DIVN. BAGHAPURAN	S/D PATTO HIRA SINGH	D046FL04	11 KV KHOTE-UPS	AMR	OK	31.03.2023		Category 5-UPS				4186547	900-450/577/1-1-1	10.750	NA	Director/D
B.11267	West	FARIDKOT	11KV	DS DIVN. BAGHAPURAN	S/D PATTO HIRA SINGH	D046FL03	11 KV RANSHI KALAN-UPS	AMR	OK	31.03.2023		Category 5-UPS				9534526	1200/577/1-1-1	11.494	NA	Director/D
B.11268	West	FARIDKOT	11KV	DS DIVN. BAGHAPURAN	S/D PATTO HIRA SINGH	D046FL20	11 KV INDUSTRIAL CAT-01	AMR	OK	31.03.2023		Category 1				9154008	1200/577/1-1-1	17.020	NA	Director/D
B.11269	West	FARIDKOT	11KV	DS DIVN. BAGHAPURAN	S/D PATTO HIRA SINGH	D046FL21	11KV BABA SINGH	AMR	OK	31.03.2023		Category 5-UPS				32682	1200/577/1-1-1	18.166	NA	Director/D
B.11270	West	FARIDKOT	11KV	DS DIVN. BAGHAPURAN	S/D PATTO HIRA SINGH	D046FL15	11KV BADHA KRISHAN	AMR	OK	31.03.2023		Category 1				91540080	1200/577/1-1-1	21.044	NA	Director/D
B.11271	West	FARIDKOT	11KV	DS DIVN. BAGHAPURAN	S/D SAMADH BHAI	C007FL05	11 KV GHOLIA KHURD-R	AMR	OK	31.03.2023		AP 3Phase 3Wire				111111111	1200/577/1-1-1	1.458	NA	Director/D
B.11272	West	FARIDKOT	11KV	DS DIVN. BAGHAPURAN	S/D SAMADH BHAI	C007FL16	11 KV MANUKE -R	AMR	OK	31.03.2023		AP 3Phase 3Wire				12479338	1200-600/5	1.581	NA	Director/D
B.11273	West	FARIDKOT	11KV	DS DIVN. BAGHAPURAN	S/D SAMADH BHAI	C007FL15	11 KV MAAL SAHIB AP	AMR	OK	31.03.2023		AP 3Phase 3Wire				111111111	1200/577/1-1-1	2.070	NA	Director/D
B.11274	West	FARIDKOT	11KV	DS DIVN. BAGHAPURAN	S/D SAMADH BHAI	C007FL18	11 KV BABA GURDITTA	AMR	OK	31.03.2023		AP 3Phase 3Wire				111	1200-600/5	2.113	NA	Director/D
B.11275	West	FARIDKOT	11KV	DS DIVN. BAGHAPURAN	S/D SAMADH BHAI	C007FL14	11 KV GAHPALA AP	AMR	OK	31.03.2023		AP 3Phase 3Wire				111	1200-600/5	2.145	NA	Director/D
B.11276	West	FARIDKOT	11KV	DS DIVN. BAGHAPURAN	S/D SAMADH BHAI	C00														

S.No	Zone	Circle	Voltage Level (kVA)	Division (kVA)	Sub-Division (kVA)	Feeder ID	Feeder Name	Feeder Metering Status (Metered/unmetered/AMR/AMI)	Status of Meter (Functional/Non-functional)	Metering Date	Date of last actual meter reading/communication	Feeder Type (Agr/Industrial/Mixed)	Status of Communication			Period from 01.04.2021 to 31.03.2022				Sales	Remarks (Source of data)
													% data received through automatically by feeder AMR/AMI	Number of hours when meter was unable to communicate in overall	Total Number of hours in the period	Meter S.No	CT/PT ratio	Import (kU)	Export (kU)		
B.11319	West	FARIDKOT	11KV	DS DIVN. BAGHAPURANA	DS S/U S/D BAGHAPURANA	D0404F15	Sekha peer babba nau gazi	AMR	OK	31.03.2023		AP 3Phase 3Wire				111111111	900-450/577/1-1-1	1.509	NA	Director/D	
B.11320	West	FARIDKOT	11KV	DS DIVN. BAGHAPURANA	DS S/U S/D BAGHAPURANA	D0404F16	11 KV SEKHA RURAL	AMR	OK	31.03.2023		AP 3Phase 3Wire				9534451	900-450/577/1-1-1	1.766	NA	Director/D	
B.11321	West	FARIDKOT	11KV	DS DIVN. BAGHAPURANA	DS S/U S/D BAGHAPURANA	D0404F14	Rofhe Kewal Singh wale(AP)	AMR	OK	31.03.2023		AP 3Phase 3Wire				111111111	900-450/577/1-1-1	1.778	NA	Director/D	
B.11322	West	FARIDKOT	11KV	DS DIVN. BAGHAPURANA	DS S/U S/D BAGHAPURANA	D0428F11	11 KV SEKHA KHURD	AMR	OK	31.03.2023		AP 3Phase 3Wire				111111111	900-450/577/1-1-1	1.871	NA	Director/D	
B.11323	West	FARIDKOT	11KV	DS DIVN. BAGHAPURANA	DS S/U S/D BAGHAPURANA	D0404F14	11 KV SANGITSAR	AMR	OK	31.03.2023		AP 3Phase 3Wire				8222633	900-450/577/1-1-1	1.921	NA	Director/D	
B.11324	West	FARIDKOT	11KV	DS DIVN. BAGHAPURANA	DS S/U S/D BAGHAPURANA	D0404F17	11 KV GURU NANAK COLLEGE RURAL	AMR	OK	31.03.2023		AP 3Phase 3Wire				8223295	900-450/577/1-1-1	2.313	NA	Director/D	
B.11325	West	FARIDKOT	11KV	DS DIVN. BAGHAPURANA	DS S/U S/D BAGHAPURANA	D0404F13	11 KV Tarkandi-(2)AP	AMR	OK	31.03.2023		AP 3Phase 3Wire				111111111	900-450/577/1-1-1	2.356	NA	Director/D	
B.11326	West	FARIDKOT	11KV	DS DIVN. BAGHAPURANA	DS S/U S/D BAGHAPURANA	D0404F16	11 KV TIBBI SAMIH (LANDE-R)	AMR	OK	31.03.2023		AP 3Phase 3Wire				8223294	900-450/577/1-1-1	2.433	NA	Director/D	
B.11327	West	FARIDKOT	11KV	DS DIVN. BAGHAPURANA	DS S/U S/D BAGHAPURANA	D0404F13	11 KV KOTHE DHALUWAL(ROD-R)	AMR	OK	31.03.2023		AP 3Phase 3Wire				7336485	900-450/577/1-1-1	2.546	NA	Director/D	
B.11328	West	FARIDKOT	11KV	DS DIVN. BAGHAPURANA	DS S/U S/D BAGHAPURANA	D0404F12	11 KV VAROKE RURAL	AMR	OK	31.03.2023		AP 3Phase 3Wire				9154458	900-450/577/1-1-1	2.553	NA	Director/D	
B.11329	West	FARIDKOT	11KV	DS DIVN. BAGHAPURANA	DS S/U S/D BAGHAPURANA	D0404F19	11 KV AULAKH RURAL	AMR	OK	31.03.2023		AP 3Phase 3Wire				8223291	900-450/577/1-1-1	2.916	NA	Director/D	
B.11330	West	FARIDKOT	11KV	DS DIVN. BAGHAPURANA	DS S/U S/D BAGHAPURANA	D0404F11	11 KV SMALASR CAT-01	AMR	OK	31.03.2023		Category 1				111111111	900-450/577/1-1-1	8.377	NA	Director/D	
B.11331	West	FARIDKOT	11KV	DS DIVN. BAGHAPURANA	DS S/U S/D BAGHAPURANA	D0404F11	11 KV LANDE-UPS	AMR	OK	31.03.2023		Category 5-UPS				9154403	900-450/577/1-1-1	9.148	NA	Director/D	
B.11332	West	FARIDKOT	11KV	DS DIVN. BAGHAPURANA	DS S/U S/D BAGHAPURANA	D0428F12	11kv Demru road	AMR	OK	31.03.2023		AP 3Phase 3Wire				4084	900-450/577/1-1-1	1.325	NA	Director/D	
B.11333	West	FARIDKOT	11KV	DS DIVN. BAGHAPURANA	DS S/U S/D BAGHAPURANA	D0428F10	BABA DALER SINGH	AMR	OK	31.03.2023		AP 3Phase 3Wire				1111111	Not installed	1.668	NA	Director/D	
B.11334	West	FARIDKOT	11KV	DS DIVN. BAGHAPURANA	DS S/U S/D BAGHAPURANA	D0428F15	11 KV NANKASAR THATH RURAL	AMR	OK	31.03.2023		AP 3Phase 3Wire				7336572	1200-600/5	2.103	NA	Director/D	
B.11335	West	FARIDKOT	11KV	DS DIVN. BAGHAPURANA	DS S/U S/D BAGHAPURANA	D0428F13	11 KV DEMRU KALAN RURAL	AMR	OK	31.03.2023		AP 3Phase 3Wire				1247988	1200-600/5	2.151	NA	Director/D	
B.11336	West	FARIDKOT	11KV	DS DIVN. BAGHAPURANA	DS S/U S/D BAGHAPURANA	D0428F10	11 KV GURUPURA RURAL	AMR	OK	31.03.2023		AP 3Phase 3Wire				7336585	1200-600/5	2.198	NA	Director/D	
B.11337	West	FARIDKOT	11KV	DS DIVN. BAGHAPURANA	DS S/U S/D BAGHAPURANA	D0428F12	11 KV DAIKARN RURAL	AMR	OK	31.03.2023		AP 3Phase 3Wire				7336671	1200-600/5	2.476	NA	Director/D	
B.11338	West	FARIDKOT	11KV	DS DIVN. BAGHAPURANA	DS S/U S/D BAGHAPURANA	D0428F11	DEMRU KHURD	AMR	OK	31.03.2023		AP 3Phase 3Wire				111111111	Not installed	2.568	NA	Director/D	
B.11339	West	FARIDKOT	11KV	DS DIVN. BAGHAPURANA	DS S/U S/D BAGHAPURANA	D0428F12	BHADRAIN WALI	AMR	OK	31.03.2023		AP 3Phase 3Wire				1111111	Not installed	2.596	NA	Director/D	
B.11340	West	FARIDKOT	11KV	DS DIVN. BAGHAPURANA	DS S/U S/D BAGHAPURANA	D0428F13	DEEP SINGH WALA	AMR	OK	31.03.2023		AP 3Phase 3Wire				111111111	Not installed	2.655	NA	Director/D	
B.11341	West	FARIDKOT	11KV	DS DIVN. BAGHAPURANA	DS S/U S/D BAGHAPURANA	D0428F11	11 KV RODE CAT-01	AMR	OK	31.03.2023		Category 1				7336677	1200-600/5	11.439	NA	Director/D	
B.11342	West	FARIDKOT	11KV	DS DIVN. FARIDKOT	DS CITY S/D FARIDKOT	C401F15	PRINCIPAL MEDICAL COLLEGE	AMR	OK	31.03.2023		Category 1				9568104	1200/577/1-1-1	0.605	NA	Director/D	
B.11343	West	FARIDKOT	11KV	DS DIVN. FARIDKOT	DS CITY S/D FARIDKOT	C401F15	FARIDKOT DIHATI	AMR	OK	31.03.2023		AP 3Phase 3Wire				8223271	1200-600/5	0.953	NA	Director/D	
B.11344	West	FARIDKOT	11KV	DS DIVN. FARIDKOT	DS CITY S/D FARIDKOT	C401F11	LINE BAZAR	AMR	OK	31.03.2023		Category 1				9154081	1200/577/1-1-1	6.041	NA	Director/D	
B.11345	West	FARIDKOT	11KV	DS DIVN. FARIDKOT	DS CITY S/D FARIDKOT	C401F17	MEDICAL	AMR	OK	31.03.2023		Category 2				9568164	1200/577/1-1-1	6.101	NA	Director/D	
B.11346	West	FARIDKOT	11KV	DS DIVN. FARIDKOT	DS CITY S/D FARIDKOT	C401F110	BHAN SINGH COLONY	NON AMR	OK	31.03.2023		Category 1				9568132	1200/577/1-1-1	6.246	NA	Director/D	
B.11347	West	FARIDKOT	11KV	DS DIVN. FARIDKOT	DS CITY S/D FARIDKOT	C401F15	FEROZPUR ROAD	AMR	OK	31.03.2023		Category 1				450	1200/577/1-1-1	6.297	NA	Director/D	
B.11348	West	FARIDKOT	11KV	DS DIVN. FARIDKOT	DS CITY S/D FARIDKOT	C401F13	INDUSTRIAL	AMR	OK	31.03.2023		Category 2				9568264	1200/577/1-1-1	7.062	NA	Director/D	
B.11349	West	FARIDKOT	11KV	DS DIVN. FARIDKOT	DS CITY S/D FARIDKOT	C401F14	GURU NANAK COLONY	AMR	OK	31.03.2023		Category 1				9568181	1200-600/5	8.012	NA	Director/D	
B.11350	West	FARIDKOT	11KV	DS DIVN. FARIDKOT	DS CITY S/D FARIDKOT	C401F19	BABA FARID	AMR	OK	31.03.2023		Category 1				9568159	1200/577/1-1-1	8.261	NA	Director/D	
B.11351	West	FARIDKOT	11KV	DS DIVN. FARIDKOT	DS CITY S/D FARIDKOT	C401F12	JAIL	AMR	OK	31.03.2023		Category 1				9568210	1200-600/5	8.443	NA	Director/D	
B.11352	West	FARIDKOT	11KV	DS DIVN. FARIDKOT	DS CITY S/D FARIDKOT	C401F18	11 KV ADARSH NAGAR 1	AMR	OK	31.03.2023		Category 1				4221156	1200/577/1-1-1	8.600	NA	Director/D	
B.11353	West	FARIDKOT	11KV	DS DIVN. FARIDKOT	DS CITY S/D FARIDKOT	C401F11	TEACHER COLONY	AMR	OK	31.03.2023		Category 1				9568131	1200/577/1-1-1	9.853	NA	Director/D	
B.11354	West	FARIDKOT	11KV	DS DIVN. FARIDKOT	DS CITY S/D FARIDKOT	C401F16	CITY	AMR	OK	31.03.2023		Category 1				9568173	1200-600/5	11.033	NA	Director/D	
B.11355	West	FARIDKOT	11KV	DS DIVN. FARIDKOT	DS CITY S/D FARIDKOT	D0436F17	NEW TEACHER COLONY	AMR	OK	31.03.2023		Category 1				9154014	900-450/577/1-1-1	5.862	NA	Director/D	
B.11356	West	FARIDKOT	11KV	DS DIVN. FARIDKOT	DS CITY S/D FARIDKOT	D0436F13	DOGAR BASTI	AMR	OK	31.03.2023		Category 1				9153998	900-450/577/1-1-1	9.317	NA	Director/D	
B.11357	West	FARIDKOT	11KV	DS DIVN. FARIDKOT	DS CITY S/D FARIDKOT	D0436F16	CITY FEEDER MINI SECTRYATE	AMR	OK	31.03.2023		Category 1				9154168	900-450/577/1-1-1	2.382	NA	Director/D	
B.11358	West	FARIDKOT	11KV	DS DIVN. FARIDKOT	DS CITY S/D FARIDKOT	D0436F14	POLICE LINE	AMR	OK	31.03.2023		Category 1				9154054	900-450/577/1-1-1	4.729	NA	Director/D	
B.11359	West	FARIDKOT	11KV	DS DIVN. FARIDKOT	DS CITY S/D FARIDKOT	D0436F15	BALIBR BASTI DHQ	AMR	OK	31.03.2023		Category 1				3149	900-450/577/1-1-1	7.107	NA	Director/D	
B.11360	West	FARIDKOT	11KV	DS DIVN. FARIDKOT	DS CITY S/D FARIDKOT	D0419F13	KANWANA GILA NAU	AMR	OK	31.03.2023		AP 3Phase 3Wire				8223780	900-450/577/1-1-1	0.965	NA	Director/D	
B.11361	West	FARIDKOT	11KV	DS DIVN. FARIDKOT	DS CITY S/D FARIDKOT	D0419F16	11 KV Ratti Roti	AMR	OK	31.03.2023		AP 3Phase 3Wire				20159	900-450/577/1-1-1	1.365	NA	Director/D	
B.11362	West	FARIDKOT	11KV	DS DIVN. FARIDKOT	DS CITY S/D FARIDKOT	D0419F11	Qila Nau	Not available	OK	31.03.2023		Category 5-UPS				3172	900-450/577/1-1-1	4.969	NA	Director/D	
B.11363	West	FARIDKOT	66KV	DS DIVN. FARIDKOT	DS CITY S/D FARIDKOT	D041907	MES	AMR	OK	31.03.2023		Category 1				Not available	Not available	11.952	NA	Director/D	
B.11364	West	FARIDKOT	11KV	DS DIVN. FARIDKOT	DS S/D GOLEWAL	C401F13	ARIYAWALA	AMR	OK	31.03.2023		AP 3Phase 3Wire				8223572	1200-600/5	1.430	NA	Director/D	
B.11365	West	FARIDKOT	11KV	DS DIVN. FARIDKOT	DS S/D GOLEWAL	D0402F19	NATHAL WALA	NON AMR	OK	31.03.2023		AP 3Phase 3Wire				7336398	900-450/577/1-1-1	0.711	NA	Director/D	
B.11366	West	FARIDKOT	11KV	DS DIVN. FARIDKOT	DS S/D GOLEWAL	D0402F19	MAVANATA WALA	AMR	OK	31.03.2023		AP 3Phase 3Wire				8223439	1200/577/1-1-1	0.726	NA	Director/D	
B.11367	West	FARIDKOT	11KV	DS DIVN. FARIDKOT	DS S/D GOLEWAL	D0402F17	RAUMWALA	AMR	OK	31.03.2023		AP 3Phase 3Wire				8223613	1200/577/1-1-1	0.776	NA	Director/D	
B.11368	West	FARIDKOT	11KV	DS DIVN. FARIDKOT	DS S/D GOLEWAL	D0402F11	HARDYALEANA	AMR	OK	31.03.2023		AP 3Phase 3Wire				8223524	1200/577/1-1-1	1.105	NA	Director/D	
B.11369	West	FARIDKOT	11KV	DS DIVN. FARIDKOT	DS S/D GOLEWAL	D0402F15	PAKHI KHURD	AMR	OK	31.03.2023		AP 3Phase 3Wire				3184	900-450/577/1-1-1	1.156	NA	Director/D	
B.11370	West	FARIDKOT	11KV	DS DIVN. FARIDKOT	DS S/D GOLEWAL	D0402F16	RUKNABEGU	AMR	OK	31.03.2023		AP 3Phase 3Wire				16198451	900-450/577/1-1-1	1.170	NA	Director/D	
B.11371	West	FARIDKOT	11KV	DS DIVN. FARIDKOT	DS S/D GOLEWAL	D0402F12	PHUL	AMR	OK	31.03.2023		AP 3Phase 3Wire				8223611	1200/577/1-1-1	1.247	NA	Director/D	
B.11372	West	FARIDKOT	11KV	DS DIVN. FARIDKOT	DS S/D GOLEWAL	D0402F13	KANYAWALA	AMR	OK	31.03.2023		AP 3Phase 3Wire				8223613	1200/577/1-1-1	1.292	NA	Director/D	
B.11373	West	FARIDKOT	11KV	DS DIVN. FARIDKOT	DS S/D GOLEWAL	D0402F18	DALEWALA														

S.No	Zone	Circle	Voltage (kVA)	Division (kVA)	Sub-Division (kVA)	Feeder ID	Feeder Name	Feeder Metering Status (Metred/unmetred/AMR/AM)	Status of Meter (Functional/Non-Functional)	Metering Date (Date of last actual meter reading/communication)	Feeder Type (Agr/Industrial/Mixed)	Status of Communication			Period from 01.04.2021 to 31.03.2022				Sales	Remarks (Source of data)
												% data received through automatically by feeder AMR/AM	Number of hours when meter was unable to communicate in overall	Total Number of hours in the period	Meter S.No	CT/PT ratio	Import (kWh)	Export (kWh)		
B.11416	West	FARIDKOT	11KV	DS DIVN. FARIDKOT	DS S/D SADIQ	D486FL03	Sangrahoor Urban	AMR	OK	31.03.2023	Category 1				5353	900-450/577/1-1	6.037	NA	Director/D	
B.11417	West	FARIDKOT	11KV	DS DIVN. FARIDKOT	DS S/D SADIQ	D419FL09	SANGURROMANA	AMR	OK	31.03.2023	AP 3Phase 3Wire				3865	900-450/577/1-1	1.090	NA	Director/D	
B.11418	West	FARIDKOT	11KV	DS DIVN. FARIDKOT	DS S/D SADIQ	D419FL02	Dhad Sher Singh	AMR	OK	31.03.2023	AP 3Phase 3Wire				8222474	900-450/577/1-1	2.527	NA	Director/D	
B.11419	West	FARIDKOT	11KV	DS DIVN. FARIDKOT	DS S/D SADIQ	D419FL07	Maachi Kalia	AMR	OK	31.03.2023	AP 3Phase 3Wire				231765	900-450/577/1-1	1.433	NA	Director/D	
B.11420	West	FARIDKOT	11KV	DS DIVN. FARIDKOT	DS S/D SADIQ	D419FL01	HARIEWALA	AMR	OK	31.03.2023	AP 3Phase 3Wire				4186082	900-450/577/1-1	1.541	NA	Director/D	
B.11421	West	FARIDKOT	11KV	DS DIVN. FARIDKOT	DS S/D SADIQ	D419FL05	SUKHANWALA	AMR	OK	31.03.2023	Category 1				4186069	900-450/577/1-1	2.557	NA	Director/D	
B.11422	West	FARIDKOT	11KV	DS DIVN. FARIDKOT	DS S/D SADIQ	D419FL04	DANA ROMANA	AMR	OK	31.03.2023	Category 5-UPS				4186071	900-450/577/1-1	3.766	NA	Director/D	
B.11423	West	FARIDKOT	11KV	DS DIVN. FARIDKOT	DS S/U S/D FARIDKOT	C401FL01	11KV BEER BHOLUWALA Rural	AMR	OK	31.03.2023	AP 3Phase 3Wire				8222925	1200-600/5	0.998	NA	Director/D	
B.11424	West	FARIDKOT	11KV	DS DIVN. FARIDKOT	DS S/U S/D FARIDKOT	D439FL05	11KV VERREWALA Rural	AMR	OK	31.03.2023	AP 3Phase 3Wire				9153613	900-450/577/1-1	1.501	NA	Director/D	
B.11425	West	FARIDKOT	11KV	DS DIVN. FARIDKOT	DS S/U S/D FARIDKOT	D439FL06	11KV CHEHAL RURAL	AMR	OK	31.03.2023	AP 3Phase 3Wire				777359	900-450/577/1-1	1.628	NA	Director/D	
B.11426	West	FARIDKOT	11KV	DS DIVN. FARIDKOT	DS S/U S/D FARIDKOT	D439FL01	11KV MACHAKI MAL SINGH UPS	AMR	OK	31.03.2023	Category 5-UPS				9154116	900-450/577/1-1	4.316	NA	Director/D	
B.11427	West	FARIDKOT	11KV	DS DIVN. FARIDKOT	DS S/U S/D FARIDKOT	D439FL02	11KV MAI GODRI SHAIB	AMR	OK	31.03.2023	Category 1				9154120	900-450/577/1-1	4.483	NA	Director/D	
B.11428	West	FARIDKOT	11KV	DS DIVN. FARIDKOT	DS S/U S/D FARIDKOT	D439FL04	11KV NE HARINDERA NAGAR	AMR	OK	31.03.2023	Category 1				9154050	900-450/577/1-1	6.347	NA	Director/D	
B.11429	West	FARIDKOT	11KV	DS DIVN. FARIDKOT	DS S/U S/D FARIDKOT	D439FL14	11 KV Puda	AMR	OK	31.03.2023	Category 4				2067964	900-450/577/1-1	0.000	NA	Director/D	
B.11430	West	FARIDKOT	11KV	DS DIVN. FARIDKOT	DS S/U S/D FARIDKOT	D439FL10	11KV PACCA Rural	AMR	OK	31.03.2023	AP 3Phase 3Wire				9154007	900-450/5	0.715	NA	Director/D	
B.11431	West	FARIDKOT	11KV	DS DIVN. FARIDKOT	DS S/U S/D FARIDKOT	D439FL03	11KV BHARAT CARD BOARD	AMR	OK	31.03.2023	Category 2				9153591	900-450/577/1-1	0.921	NA	Director/D	
B.11432	West	FARIDKOT	11KV	DS DIVN. FARIDKOT	DS S/U S/D FARIDKOT	D439FL11	11KV TEHNA RUREL	AMR	OK	31.03.2023	AP 3Phase 3Wire				9154012	900-450/5	1.331	NA	Director/D	
B.11433	West	FARIDKOT	11KV	DS DIVN. FARIDKOT	DS S/U S/D FARIDKOT	D439FL12	11KV MOOREEN JAIL	AMR	OK	31.03.2023	Category 2				10282813	900-450/577/1-1	1.620	NA	Director/D	
B.11434	West	FARIDKOT	11KV	DS DIVN. FARIDKOT	DS S/U S/D FARIDKOT	D439FL09	11KV BHANA Rural	AMR	OK	31.03.2023	AP 3Phase 3Wire				9154162	900-450/5	1.686	NA	Director/D	
B.11435	West	FARIDKOT	11KV	DS DIVN. FARIDKOT	DS S/U S/D FARIDKOT	D439FL06	11KV WATER WORKS	AMR	OK	31.03.2023	Category 1				9154162	900-450/5	1.774	NA	Director/D	
B.11436	West	FARIDKOT	11KV	DS DIVN. FARIDKOT	DS S/U S/D FARIDKOT	D439FL13	11KV TAO AGR	AMR	OK	31.03.2023	Category 1				9153748	900-450/577/1-1	1.777	NA	Director/D	
B.11437	West	FARIDKOT	11KV	DS DIVN. FARIDKOT	DS S/U S/D FARIDKOT	D439FL01	11KV GREEN AVENUE	AMR	OK	31.03.2023	Category 1				9153610	900-450/577/1-1	4.299	NA	Director/D	
B.11438	West	FARIDKOT	11KV	DS DIVN. FARIDKOT	DS S/U S/D FARIDKOT	D439FL08	11KV Chehal UPS	AMR	OK	31.03.2023	Category 5-UPS				9154174	900-450/5	8.112	NA	Director/D	
B.11439	West	FARIDKOT	11KV	DS DIVN. FARIDKOT	DS S/U S/D FARIDKOT	D439FL02	11KV HARINDERA NAGAR	AMR	OK	31.03.2023	Category 1				9154073	900-450/577/1-1	8.163	NA	Director/D	
B.11440	West	FARIDKOT	11KV	DS DIVN. FARIDKOT	DS S/U S/D FARIDKOT	D439FL16	11 KV GURU ANGAO DEV G UPS	AMR	OK	31.03.2023	Category 5-UPS				3183	900-450/577/1-1	8.768	NA	Director/D	
B.11441	West	FARIDKOT	11KV	DS DIVN. FARIDKOT	DS S/U S/D FARIDKOT	D439FL07	11KV SANAY NAGAR	AMR	OK	31.03.2023	Category 1				9154117	900-450/5	14.234	NA	Director/D	
B.11442	West	FARIDKOT	11KV	DS DIVN. FARIDKOT	DS S/U S/D FARIDKOT	D420FL04	11KV DHUKROT Rural	AMR	OK	31.03.2023	AP 3Phase 3Wire				8222465	1200/577/1-1	1.651	NA	Director/D	
B.11443	West	FARIDKOT	11KV	DS DIVN. FARIDKOT	DS S/U S/D FARIDKOT	D420FL02	11KV BAGIANA Rural	AMR	OK	31.03.2023	AP 3Phase 3Wire				8222463	1200/577/1-1	1.957	NA	Director/D	
B.11444	West	FARIDKOT	11KV	DS DIVN. FARIDKOT	DS S/U S/D FARIDKOT	D420FL08	11KV MATILI Rural	AMR	OK	31.03.2023	AP 3Phase 3Wire				9153631	900-450/577/1-1	2.050	NA	Director/D	
B.11445	West	FARIDKOT	11KV	DS DIVN. FARIDKOT	DS S/U S/D FARIDKOT	D420FL03	11KV CHAK DHUDI RURAL	AMR	OK	31.03.2023	AP 3Phase 3Wire				8222461	1200/577/1-1	2.237	NA	Director/D	
B.11446	West	FARIDKOT	11KV	DS DIVN. FARIDKOT	DS S/U S/D FARIDKOT	D420FL06	11KV CHAMELI Rural	AMR	OK	31.03.2023	AP 3Phase 3Wire				8222462	900-450/577/1-1	2.486	NA	Director/D	
B.11447	West	FARIDKOT	11KV	DS DIVN. FARIDKOT	DS S/U S/D FARIDKOT	D420FL09	CHAKER AP	AMR	OK	31.03.2023	AP 3Phase 3Wire				8222462	900-450/577/1-1	2.655	NA	Director/D	
B.11448	West	FARIDKOT	11KV	DS DIVN. FARIDKOT	DS S/U S/D FARIDKOT	D420FL11	BABA SHANID UPS	AMR	OK	31.03.2023	Category 5-UPS				4096	900-450/577/1-1	2.903	NA	Director/D	
B.11449	West	FARIDKOT	11KV	DS DIVN. FARIDKOT	DS S/U S/D FARIDKOT	D420FL01	11KV KOT SUKHA	AMR	OK	31.03.2023	Category 5-UPS				6745325	1200/577/1-1	4.526	NA	Director/D	
B.11450	West	FARIDKOT	11KV	DS DIVN. FARIDKOT	DS S/U S/D FARIDKOT	D420FL05	11KV DHUDI UPS	AMR	OK	31.03.2023	Category 5-UPS				4187892	900-450/577/1-1	7.303	NA	Director/D	
B.11451	West	FARIDKOT	11KV	DS DIVN. FARIDKOT	DS S/U S/D FARIDKOT	D401FL03	11KV MORANWALI Rural	AMR	OK	31.03.2023	AP 3Phase 3Wire				8223777	900-450/577/1-1	0.636	NA	Director/D	
B.11452	West	FARIDKOT	11KV	DS DIVN. FARIDKOT	DS S/U S/D FARIDKOT	D401FL01	11KV MALEE WALA ROAD Rural	AMR	OK	31.03.2023	AP 3Phase 3Wire				111111111	900-450/577/1-1	0.760	NA	Director/D	
B.11453	West	FARIDKOT	11KV	DS DIVN. FARIDKOT	DS S/U S/D FARIDKOT	D401FL02	11KV BHAGATHALA Rural	AMR	OK	31.03.2023	AP 3Phase 3Wire				8233778	900-450/577/1-1	1.354	NA	Director/D	
B.11454	West	FARIDKOT	11KV	DS DIVN. FARIDKOT	DS S/U S/D FARIDKOT	D401FL09	JORIAN NAHRAN	AMR	OK	31.03.2023	Category 5-UPS				111111111	900-450/577/1-1	2.625	NA	Director/D	
B.11455	West	FARIDKOT	11KV	DS DIVN. FARIDKOT	DS S/U S/D FARIDKOT	D401FL07	11KV FAKHI	AMR	OK	31.03.2023	Category 5-UPS				111111111	900-450/577/1-1	3.781	NA	Director/D	
B.11456	West	FARIDKOT	11KV	DS DIVN. FARIDKOT	DS S/U S/D FARIDKOT	D401FL05	11KV HASSAN BHATTI	AMR	OK	31.03.2023	Category 5-UPS				2067182	900-450/577/1-1	5.259	NA	Director/D	
B.11457	West	FARIDKOT	11KV	DS DIVN. FARIDKOT	DS S/U S/D FARIDKOT	D407FL02	11KV DHUKROT Rural D478	AMR	OK	31.03.2023	AP 3Phase 3Wire				1028181	900-450/5	1.653	NA	Director/D	
B.11458	West	FARIDKOT	11KV	DS DIVN. FARIDKOT	DS S/U S/D FARIDKOT	D407FL06	11KV MANDOWLA Rural	AMR	OK	31.03.2023	AP 3Phase 3Wire				11334	900-450/5	1.715	NA	Director/D	
B.11459	West	FARIDKOT	11KV	DS DIVN. FARIDKOT	DS S/U S/D FARIDKOT	D445FL09	NEW PACCA AP	AMR	OK	31.03.2023	AP 3Phase 3Wire				3329	900-450/577/1-1	0.891	NA	Director/D	
B.11460	West	FARIDKOT	11KV	DS DIVN. FARIDKOT	DS S/U S/D FARIDKOT	D445FL02	11KV BABA PEER Rural	AMR	OK	31.03.2023	AP 3Phase 3Wire				7312175	900-450/577/1-1	1.110	NA	Director/D	
B.11461	West	FARIDKOT	11KV	DS DIVN. FARIDKOT	DS S/U S/D FARIDKOT	D445FL08	11 KV Moran Wali	AMR	OK	31.03.2023	AP 3Phase 3Wire				23588	900-450/577/1-1	1.261	NA	Director/D	
B.11462	West	FARIDKOT	11KV	DS DIVN. FARIDKOT	DS S/U S/D FARIDKOT	D445FL05	11KV DHUKOT Rural	NON AMR	OK	31.03.2023	AP 3Phase 3Wire				7312172	900-450/577/1-1	1.313	NA	Director/D	
B.11463	West	FARIDKOT	11KV	DS DIVN. FARIDKOT	DS S/U S/D FARIDKOT	D445FL06	11KV MOHRI WALA Rural	AMR	OK	31.03.2023	AP 3Phase 3Wire				33442	900-450/577/1-1	1.366	NA	Director/D	
B.11464	West	FARIDKOT	11KV	DS DIVN. FARIDKOT	DS S/U S/D FARIDKOT	D445FL01	11KV MALEE	AMR	OK	31.03.2023	Category 5-UPS				7312171	900-450/577/1-1	1.636	NA	Director/D	
B.11465	West	FARIDKOT	11KV	DS DIVN. FARIDKOT	DS S/U S/D FARIDKOT	D445FL04	11KV CHAND BAJA Rural	AMR	OK	31.03.2023	AP 3Phase 3Wire				7312173	900-450/577/1-1	1.660	NA	Director/D	
B.11466	West	FARIDKOT	11KV	DS DIVN. FARIDKOT	DS S/U S/D FARIDKOT	D445FL10	Baba Khetar pal AP	NON AMR	OK	31.03.2023	AP 3Phase 3Wire				73195027	900-450/577/1-1	1.703	NA	Director/D	
B.11467	West	FARIDKOT	11KV	DS DIVN. FARIDKOT	DS S/U S/D FARIDKOT	D445FL02	11KV DHANI MAND Rural	AMR	OK	31.03.2023	AP 3Phase 3Wire				33515	900-450/577/1-1	1.803	NA	Director/D	
B.11468	West	FARIDKOT	11KV	DS DIVN. FARIDKOT	DS S/U S/D FARIDKOT	D445FL11	MANDWALA	AMR	OK	31.03.2023	Category 5-UPS				3170	900-450/577/1-1	3.188	NA	Director/D	
B.11469	West	FARIDKOT	11KV	DS DIVN. FARIDKOT	DS S/U S/D FARIDKOT	D445FL07	11 KV Ghumara	AMR	OK	31.03.2023	Category 5-UPS				23654	900-450/577/1-1	1.541	NA	Director/D	
B.11470	West	FARIDKOT	11KV	DS DIVN. KOTKAPURA	DS CITY S/D KOTKAPURA	C403FL02	JKV	OK	31.03.2023	Category 1				9568151	1200-600/5	0.657	NA	Director/D		
B.11471	West	FARIDKOT	11KV	DS DIVN. KOTKAPURA	DS CITY S/D KOTKAPURA	C403FL06	Nanakar	AMR	OK	31.03.2023	AP 3Phase 3Wire				111111111	1200-600/5	1.914	NA	Director/D	

S.No	Zone	Circle	Voltage Level (kVA)	Division (kVA)	Sub-Division (kVA)	Feeder ID	Feeder Name	Feeder Metering Status (Metered/unmetered/AMR/AM)	Status of Meter (Functional/Non-functional)	Metering Date	Feeder Type (Agr/Industrial/Mixed)	Status of Communication			Period from 01.04.2021 to 31.03.2022				Sales	Remarks (Source of data)
												% data received through automatically by feeder AMR/AM	Number of hours when meter was unable to communicate in overall	Total Number of hours in the period	Meter S.No	CT/PT ratio	Import (kU)	Export (kU)		
B.11513	West	FARIDKOT	11KV	DS DIVN. KOTKAPURA	DS S/D BAJAKHANA	D418FL04	Ghania Rural	NON AMR	OK	31.03.2023	AP 3Phase 3Wire				11111111	1200/577/1-1-1	2.658	NA	Director/D	
B.11514	West	FARIDKOT	11KV	DS DIVN. KOTKAPURA	DS S/D BAJAKHANA	D418FL10	Romana AP	NON AMR	OK	31.03.2023	AP 3Phase 3Wire				11111	900-450/577/1-1-1	2.701	NA	Director/D	
B.11515	West	FARIDKOT	11KV	DS DIVN. KOTKAPURA	DS S/D BAJAKHANA	D418FL13	Cobinriarth AP	AMR	OK	31.03.2023	AP 3Phase 3Wire				33479	900-450/577/1-1-1	3.053	NA	Director/D	
B.11516	West	FARIDKOT	11KV	DS DIVN. KOTKAPURA	DS S/D BAJAKHANA	D418FL02	Ajit Singh Wala	AMR	OK	31.03.2023	Category 5-U/PS				11111111	1200/577/1-1-1	5.491	NA	Director/D	
B.11517	West	FARIDKOT	11KV	DS DIVN. KOTKAPURA	DS S/D BAJAKHANA	SUKHFL07	Shiwala	NON AMR	OK	31.03.2023	AP 3Phase 3Wire				7336732	Not installed	2.716	NA	Director/D	
B.11518	West	FARIDKOT	11KV	DS DIVN. KOTKAPURA	DS S/D BAJAKHANA	SUKHFL11	Jandhu Sahib	AMR	OK	31.03.2023	AP 3Phase 3Wire				37042	900-450/577/1-1-1	3.065	NA	Director/D	
B.11519	West	FARIDKOT	11KV	DS DIVN. KOTKAPURA	DS S/D BARGARI	D416FL03	Gurdwara Tibbi Sahib/Lohara	NON AMR	OK	31.03.2023	AP 3Phase 3Wire				8222869	900-450/577/1-1-1	2.106	NA	Director/D	
B.11520	West	FARIDKOT	11KV	DS DIVN. KOTKAPURA	DS S/D BARGARI	D416FL12	Baba Sahid AP/Feeder	AMR	OK	31.03.2023	AP 3Phase 3Wire				11111	900-450/577/1-1-1	2.266	NA	Director/D	
B.11521	West	FARIDKOT	11KV	DS DIVN. KOTKAPURA	DS S/D BARGARI	D416FL18	Bhundanar AP	NON AMR	OK	31.03.2023	AP 3Phase 3Wire				111111	900-450/577/1-1-1	2.277	NA	Director/D	
B.11522	West	FARIDKOT	11KV	DS DIVN. KOTKAPURA	DS S/D BARGARI	D416FL13	KOTHE BHALLURIA	AMR	OK	31.03.2023	AP 3Phase 3Wire				8222869	900-450/577/1-1-1	2.277	NA	Director/D	
B.11523	West	FARIDKOT	11KV	DS DIVN. KOTKAPURA	DS S/D BARGARI	D416FL06	SAHOKE	AMR	OK	31.03.2023	AP 3Phase 3Wire				8223260	900-450/577/1-1-1	2.287	NA	Director/D	
B.11524	West	FARIDKOT	11KV	DS DIVN. KOTKAPURA	DS S/D BARGARI	D416FL10	RAN SINGH WALA	AMR	OK	31.03.2023	AP 3Phase 3Wire				8222697	900-450/577/1-1-1	2.433	NA	Director/D	
B.11525	West	FARIDKOT	11KV	DS DIVN. KOTKAPURA	DS S/D BARGARI	D416FL08	VANDER	AMR	OK	31.03.2023	AP 3Phase 3Wire				8223258	900-450/577/1-1-1	2.443	NA	Director/D	
B.11526	West	FARIDKOT	11KV	DS DIVN. KOTKAPURA	DS S/D BARGARI	D416FL02	GONDARRA	AMR	OK	31.03.2023	AP 3Phase 3Wire				8223256	900-450/577/1-1-1	2.550	NA	Director/D	
B.11527	West	FARIDKOT	11KV	DS DIVN. KOTKAPURA	DS S/D BARGARI	D416FL01	SUNAN	NON AMR	OK	31.03.2023	AP 3Phase 3Wire				8223257	900-450/577/1-1-1	2.575	NA	Director/D	
B.11528	West	FARIDKOT	11KV	DS DIVN. KOTKAPURA	DS S/D BARGARI	D416FL17	Dera Jalal	NON AMR	OK	31.03.2023	AP 3Phase 3Wire				1111111111	900-450/577/1-1-1	2.583	NA	Director/D	
B.11529	West	FARIDKOT	11KV	DS DIVN. KOTKAPURA	DS S/D BARGARI	D416FL16	BHAI BEHLD	AMR	OK	31.03.2023	AP 3Phase 3Wire				1111111	900-450/577/1-1-1	2.716	NA	Director/D	
B.11530	West	FARIDKOT	11KV	DS DIVN. KOTKAPURA	DS S/D BARGARI	D416FL09	BAMBHIA BHAJ	NON AMR	OK	31.03.2023	AP 3Phase 3Wire				8223259	900-450/577/1-1-1	2.894	NA	Director/D	
B.11531	West	FARIDKOT	11KV	DS DIVN. KOTKAPURA	DS S/D BARGARI	D416FL15	LOHARA	NON AMR	OK	31.03.2023	AP 3Phase 3Wire				1111111	900-450/577/1-1-1	3.044	NA	Director/D	
B.11532	West	FARIDKOT	11KV	DS DIVN. KOTKAPURA	DS S/D BARGARI	D416FL14	DEDA MUNI	AMR	OK	31.03.2023	AP 3Phase 3Wire				11111	900-450/577/1-1-1	3.101	NA	Director/D	
B.11533	West	FARIDKOT	11KV	DS DIVN. KOTKAPURA	DS S/D BARGARI	D416FL20	11 KV GLOBAL UPS	AMR	OK	31.03.2023	Category 5-U/PS				11111111	900-450/577/1-1-1	3.245	NA	Director/D	
B.11534	West	FARIDKOT	11KV	DS DIVN. KOTKAPURA	DS S/D BARGARI	D416FL05	BURJ HARIKA	AMR	OK	31.03.2023	Category 5-U/PS				8223755	900-450/577/1-1-1	5.864	NA	Director/D	
B.11535	West	FARIDKOT	11KV	DS DIVN. KOTKAPURA	DS S/D BARGARI	D416FL07	BARGARI	AMR	OK	31.03.2023	Category 5-U/PS				GE6 608	900-450/577/1-1-1	9.665	NA	Director/D	
B.11536	West	FARIDKOT	11KV	DS DIVN. KOTKAPURA	DS S/D BARGARI	D416FL11	BURJ JAWAHAR SINGH WALA	AMR	OK	31.03.2023	Category 5-U/PS				2067367	900-450/577/1-1-1	9.880	NA	Director/D	
B.11537	West	FARIDKOT	11KV	DS DIVN. KOTKAPURA	DS S/D BARGARI	D423FL12	Baba Mast ram	AMR	OK	31.03.2023	AP 3Phase 3Wire				1111111	900-450/577/1-1-1	1.557	NA	Director/D	
B.11538	West	FARIDKOT	11KV	DS DIVN. KOTKAPURA	DS S/D BARGARI	D423FL09	Dera Akhara	AMR	OK	31.03.2023	AP 3Phase 3Wire				8224276	900-450/577/1-1-1	1.972	NA	Director/D	
B.11539	West	FARIDKOT	11KV	DS DIVN. KOTKAPURA	DS S/D BARGARI	D423FL05	Sangatsar	AMR	OK	31.03.2023	AP 3Phase 3Wire				8224279	900-450/577/1-1-1	2.345	NA	Director/D	
B.11540	West	FARIDKOT	11KV	DS DIVN. KOTKAPURA	DS S/D BARGARI	D423FL03	Baba Gumannand Singh	AMR	OK	31.03.2023	AP 3Phase 3Wire				8224280	900-450/577/1-1-1	2.819	NA	Director/D	
B.11541	West	FARIDKOT	11KV	DS DIVN. KOTKAPURA	DS S/D BARGARI	D423FL01	MALKE	AMR	OK	31.03.2023	Category 1				12479733	900-450/577/1-1-1	3.268	NA	Director/D	
B.11542	West	FARIDKOT	11KV	DS DIVN. KOTKAPURA	DS S/D BARGARI	D41FL00	MOUR NAU ABAD	AMR	OK	31.03.2023	AP 3Phase 3Wire				12527331	1200/577/1-1-1	0.804	NA	Director/D	
B.11543	West	FARIDKOT	11KV	DS DIVN. KOTKAPURA	DS S/D BARGARI	D41FL09	THATH BHAI (MARR)	AMR	OK	31.03.2023	AP 3Phase 3Wire				1112222	900-450/577/1-1-1	2.895	NA	Director/D	
B.11544	West	FARIDKOT	11KV	DS DIVN. KOTKAPURA	DS S/D BARGARI	D416FL07	Kothe Sainan	AMR	OK	31.03.2023	Category 5-U/PS				11111111	900-450/577/1-1-1	4.467	NA	Director/D	
B.11545	West	FARIDKOT	11KV	DS DIVN. KOTKAPURA	DS S/D BARGARI	D416FL05	GURUSAR	AMR	OK	31.03.2023	AP 3Phase 3Wire				9534555	900-450/577/1-1-1	1.831	NA	Director/D	
B.11546	West	FARIDKOT	11KV	DS DIVN. KOTKAPURA	DS S/D BARGARI	D416FL04	Baba Jal See Ram	AMR	OK	31.03.2023	AP 3Phase 3Wire				9534484	900-450/577/1-1-1	2.100	NA	Director/D	
B.11547	West	FARIDKOT	11KV	DS DIVN. KOTKAPURA	DS S/D BARGARI	FL05D441	NIAMWALA AP	AMR	OK	31.03.2023	AP 3Phase 3Wire				1111	900-450/577/1-1-1	2.706	NA	Director/D	
B.11548	West	FARIDKOT	11KV	DS DIVN. KOTKAPURA	DS S/D BARGARI	D41FL03	RAMSAR	AMR	OK	31.03.2023	AP 3Phase 3Wire				9534440	900-450/577/1-1-1	2.758	NA	Director/D	
B.11549	West	FARIDKOT	11KV	DS DIVN. KOTKAPURA	DS S/D BARGARI	D416FL01	SARAWAN URBAN	AMR	OK	31.03.2023	Category 4				9534402	900-450/577/1-1-1	3.505	NA	Director/D	
B.11550	West	FARIDKOT	11KV	DS DIVN. KOTKAPURA	DS S/D BARGARI	D416FL02	BEHAL-KALAN UPS	NON AMR	OK	31.03.2023	Category 5-U/PS				9534546	900-450/577/1-1-1	6.943	NA	Director/D	
B.11551	West	FARIDKOT	11KV	DS DIVN. KOTKAPURA	DS S/D BARGARI	X358FL12	Baba Dhama singh	AMR	OK	31.03.2023	AP 3Phase 3Wire				123456	900-450/577/1-1-1	1.908	NA	Director/D	
B.11552	West	FARIDKOT	11KV	DS DIVN. KOTKAPURA	DS S/D BARGARI	SUKHFL09	WANDER (SUKHANAND)	NON AMR	OK	31.03.2023	AP 3Phase 3Wire				7336704	Not installed	2.071	NA	Director/D	
B.11553	West	FARIDKOT	11KV	DS DIVN. KOTKAPURA	DS S/D BARGARI	X358FL13	Ajilgah	NON AMR	OK	31.03.2023	AP 3Phase 3Wire				4585	900-450/577/1-1-1	2.515	NA	Director/D	
B.11554	West	FARIDKOT	11KV	DS DIVN. KOTKAPURA	DS S/D BARGARI	SUKHFL12	Baba Sunder Singh	AMR	OK	31.03.2023	AP 3Phase 3Wire				1519377	900-450/577/1-1-1	2.638	NA	Director/D	
B.11555	West	FARIDKOT	11KV	DS DIVN. KOTKAPURA	DS S/D BARGARI	SUKHFL10	REEDA	AMR	OK	31.03.2023	Category 5-U/PS				7336679	900-450/577/1-1-1	6.804	NA	Director/D	
B.11556	West	FARIDKOT	11KV	DS DIVN. KOTKAPURA	DS S/D JAITO	D442FL11	Baba Gudhar Singh ji	AMR	OK	31.03.2023	AP 3Phase 3Wire				11111	900-450/577/1-1-1	1.104	NA	Director/D	
B.11557	West	FARIDKOT	11KV	DS DIVN. KOTKAPURA	DS S/D JAITO	D442FL02	KARRI WALI	AMR	OK	31.03.2023	AP 3Phase 3Wire				9153601	900-450/577/1-1-1	2.023	NA	Director/D	
B.11558	West	FARIDKOT	11KV	DS DIVN. KOTKAPURA	DS S/D JAITO	D442FL01	chana	AMR	OK	31.03.2023	Category 5-U/PS				9153593	900-450/577/1-1-1	2.312	NA	Director/D	
B.11559	West	FARIDKOT	11KV	DS DIVN. KOTKAPURA	DS S/D JAITO	D442FL03	BISHNANDI RURAL	AMR	OK	31.03.2023	AP 3Phase 3Wire				9153584	900-450/577/1-1-1	2.703	NA	Director/D	
B.11560	West	FARIDKOT	11KV	DS DIVN. KOTKAPURA	DS S/D JAITO	D442FL08	BAHA SHABD	AMR	OK	31.03.2023	AP 3Phase 3Wire				9153588	900-450/577/1-1-1	2.775	NA	Director/D	
B.11561	West	FARIDKOT	11KV	DS DIVN. KOTKAPURA	DS S/D JAITO	D442FL06	SIKHWAL	AMR	OK	31.03.2023	AP 3Phase 3Wire				111111	900-450/577/1-1-1	3.012	NA	Director/D	
B.11562	West	FARIDKOT	11KV	DS DIVN. KOTKAPURA	DS S/D JAITO	D442FL12	Kothe Bachan Singh	AMR	OK	31.03.2023	AP 3Phase 3Wire				98804082	900-450/577/1-1-1	3.139	NA	Director/D	
B.11563	West	FARIDKOT	11KV	DS DIVN. KOTKAPURA	DS S/D JAITO	D442FL04	Rameana Rural	NON AMR	OK	31.03.2023	AP 3Phase 3Wire				9153603	900-450/577/1-1-1	3.241	NA	Director/D	
B.11564	West	FARIDKOT	11KV	DS DIVN. KOTKAPURA	DS S/D JAITO	D442FL10	Khachra AP	AMR	OK	31.03.2023	AP 3Phase 3Wire				11111	900-450/577/1-1-1	3.482	NA	Director/D	
B.11565	West	FARIDKOT	11KV	DS DIVN. KOTKAPURA	DS S/D JAITO	D442FL05	Rori Kapura Rural	AMR	OK	31.03.2023	AP 3Phase 3Wire				28662	900-450/577/1-1-1	3.484	NA	Director/D	
B.11566	West	FARIDKOT	11KV	DS DIVN. KOTKAPURA	DS S/D JAITO	D442FL03	11 KV Kalghat upps	AMR	OK	31.03.2023	Category 5-U/PS				11111111	900-450/577/1-1-1	4.653	NA	Director/D	
B.11567	West	FARIDKOT	11KV	DS DIVN. KOTKAPURA	DS S/D JAITO	D442FL06	Bhagatiana UPS	AMR	OK	31.03.2023	Category 5-U/PS				9153602	900-450/577/1-1-1	6.246	NA	Director/D	
B.11568	West	FARIDKOT	11KV	DS DIVN. KOTKAPURA	DS S/D JAITO	D422FL14	CIVIL HOSPITAL	AMR	OK	31.03.2023	Category 4				12093481	900-450/577/1-1-1	0.029	NA	Director/D</	

S.No	Zone	Circle	Voltage (kVA)	Division (kVA)	Sub-Division (kVA)	Feeder ID	Feeder Name	Feeder Metering Status (Metered/unmetered/AMR/AMI)	Status of Meter (Functional/Non-Functional)	Metering Date	Feeder Type (Agr/Industrial/Mixed)	Status of Communication			Period from 01.04.2021 to 31.03.2022				Sales	Remarks (Source of data)
												% data received through automatically if feeder AMR/AMI	Number of hours when meter was unable to communicate in period	Total Number of hours in the period	Meter S.No	CT/PT ratio	Import (kWh)	Export (kWh)		
B.11610	West	FARIDKOT	11KV	DS DIVN. KOTKAPURA	DS S/U S/D KOTKAPURA	C404FL03	Prem Nagar	AMR	OK	31.03.2023	Category 1				9568124	1200-600/5	11.664	NA	Director/D	
B.11611	West	FARIDKOT	11KV	DS DIVN. KOTKAPURA	DS S/U S/D KOTKAPURA	C405FL07	SIRSRI ROAD	AMR	OK	31.03.2023	AP 3Phase 3Wire				8222476	900-450/5	1.830	NA	Director/D	
B.11612	West	FARIDKOT	11KV	DS DIVN. KOTKAPURA	DS S/U S/D KOTKAPURA	C405FL02	Aulakh Old	AMR	OK	31.03.2023	AP 3Phase 3Wire				8222477	900-450/5	1.900	NA	Director/D	
B.11613	West	FARIDKOT	11KV	DS DIVN. KOTKAPURA	DS S/U S/D KOTKAPURA	C405FL08	MIRZA PATTI AP	AMR	OK	31.03.2023	AP 3Phase 3Wire				9154003	900-450/5	2.222	NA	Director/D	
B.11614	West	FARIDKOT	11KV	DS DIVN. KOTKAPURA	DS S/U S/D KOTKAPURA	C405FL10	DEMUR ROAD AP	AMR	OK	31.03.2023	AP 3Phase 3Wire				9153635	900-450/5	2.388	NA	Director/D	
B.11615	West	FARIDKOT	11KV	DS DIVN. KOTKAPURA	DS S/U S/D KOTKAPURA	C405FL11	GHSANE WALA	AMR	OK	31.03.2023	AP 3Phase 3Wire				1111111	900-450/577/1-1	2.472	NA	Director/D	
B.11616	West	FARIDKOT	11KV	DS DIVN. KOTKAPURA	DS S/U S/D KOTKAPURA	C405FL01	KOTHE - THEH	AMR	OK	31.03.2023	AP 3Phase 3Wire				2067787	900-450/577/1-1	2.660	NA	Director/D	
B.11617	West	FARIDKOT	11KV	DS DIVN. KOTKAPURA	DS S/U S/D KOTKAPURA	C405FL04	Panji Grain	AMR	OK	31.03.2023	AP 3Phase 3Wire				8223043	900-450/5	2.802	NA	Director/D	
B.11618	West	FARIDKOT	11KV	DS DIVN. KOTKAPURA	DS S/U S/D KOTKAPURA	C405FL05	Aulakh New	AMR	OK	31.03.2023	AP 3Phase 3Wire				1480	900-450/577/1-1	2.815	NA	Director/D	
B.11619	West	FARIDKOT	11KV	DS DIVN. KOTKAPURA	DS S/U S/D KOTKAPURA	C405FL09	MOGA ROAD AP	AMR	OK	31.03.2023	AP 3Phase 3Wire				2067091	900-450/577/1-1	3.416	NA	Director/D	
B.11620	West	FARIDKOT	11KV	DS DIVN. KOTKAPURA	DS S/U S/D KOTKAPURA	C405FL12	Devi wala road UPS	AMR	OK	31.03.2023	AP 3Phase 5-UPS				11111111	900-450/577/1-1	3.512	NA	Director/D	
B.11621	West	FARIDKOT	11KV	DS DIVN. KOTKAPURA	DS S/U S/D KOTKAPURA	C405FL06	Jwanwala	AMR	OK	31.03.2023	Category 5-UPS				9154020	900-450/5	7.435	NA	Director/D	
B.11622	West	FARIDKOT	11KV	DS DIVN. KOTKAPURA	DS S/U S/D KOTKAPURA	C405FL03	Panji Grain	AMR	OK	31.03.2023	Category 1				2067867	900-450/577/1-1	9.481	NA	Director/D	
B.11623	West	FARIDKOT	11KV	DS DIVN. KOTKAPURA	DS S/U S/D KOTKAPURA	D420FL10	JOKRA SAHIB NAGAL	AMR	OK	31.03.2023	AP 3Phase 3Wire				16194405	900-450/577/1-1	1.336	NA	Director/D	
B.11624	West	FARIDKOT	11KV	DS DIVN. KOTKAPURA	DS S/U S/D KOTKAPURA	D420FL07	Jwanwala	AMR	OK	31.03.2023	AP 3Phase 3Wire				8222464	1200/577/1-1	2.865	NA	Director/D	
B.11625	West	FARIDKOT	11KV	DS DIVN. KOTKAPURA	DS S/U S/D KOTKAPURA	D440FL04	Koche Ramsar	AMR	OK	31.03.2023	AP 3Phase 3Wire				9154495	900-450/577/1-1	2.499	NA	Director/D	
B.11626	West	FARIDKOT	11KV	DS DIVN. KOTKAPURA	DS S/U S/D KOTKAPURA	D440FL05	Koche Mahal	NON AMR	OK	31.03.2023	AP 3Phase 3Wire				9154489	900-450/577/1-1	3.050	NA	Director/D	
B.11627	West	FARIDKOT	11KV	DS DIVN. KOTKAPURA	DS S/U S/D KOTKAPURA	D440FL06	Arvind Nagar Feeder	AMR	OK	31.03.2023	Category 1				11111111	900-450/577/1-1	4.563	NA	Director/D	
B.11628	West	FARIDKOT	11KV	DS DIVN. KOTKAPURA	DS S/U S/D KOTKAPURA	D440FL03	DHLWAN URBAN	AMR	OK	31.03.2023	Category 1				9154475	900-450/577/1-1	5.829	NA	Director/D	
B.11629	West	FARIDKOT	11KV	DS DIVN. KOTKAPURA	DS S/U S/D KOTKAPURA	D421FL07	Panji Grain Khurd	AMR	OK	31.03.2023	AP 3Phase 3Wire				11111111	900-450/577/1-1	2.552	NA	Director/D	
B.11630	West	FARIDKOT	11KV	DS DIVN. KOTKAPURA	DS S/U S/D KOTKAPURA	D415FL06	CHAK DHIMANWALI	AMR	OK	31.03.2023	AP 3Phase 3Wire				10288358	900-450/5	1.359	NA	Director/D	
B.11631	West	FARIDKOT	11KV	DS DIVN. KOTKAPURA	DS S/U S/D KOTKAPURA	D437FL08	HIGH TECH	AMR	OK	31.03.2023	Category 4				10283034	900-450/577/1-1	0.002	NA	Director/D	
B.11632	West	FARIDKOT	11KV	DS DIVN. KOTKAPURA	DS S/U S/D KOTKAPURA	D437FL07	Army	AMR	OK	31.03.2023	Category 4				9568207	400-200/5	0.110	NA	Director/D	
B.11633	West	FARIDKOT	11KV	DS DIVN. KOTKAPURA	DS S/U S/D KOTKAPURA	D437FL09	Nangal AP	AMR	OK	31.03.2023	AP 3Phase 3Wire				23458	400-200/5	1.742	NA	Director/D	
B.11634	West	FARIDKOT	11KV	DS DIVN. KOTKAPURA	DS S/U S/D KOTKAPURA	D437FL02	Sikhanwala	AMR	OK	31.03.2023	AP 3Phase 3Wire				9568116	900-450/577/1-1	2.443	NA	Director/D	
B.11635	West	FARIDKOT	11KV	DS DIVN. KOTKAPURA	DS S/U S/D KOTKAPURA	D437FL04	Nathwala	AMR	OK	31.03.2023	Category 5-UPS				9568204	900-450/577/1-1	6.393	NA	Director/D	
B.11636	West	FARIDKOT	11KV	DS DIVN. KOTKAPURA	DS S/U S/D KOTKAPURA	D437FL06	Sandhwan	AMR	OK	31.03.2023	Category 1				9568206	900-450/577/1-1	8.017	NA	Director/D	
B.11637	West	FARIDKOT	11KV	DS DIVN. KOTKAPURA	DS S/U S/D KOTKAPURA	D437FL05	Dana Mandi Old	AMR	OK	31.03.2023	Category 1				9568207	400-200/5	8.258	NA	Director/D	
B.11638	West	FARIDKOT	11KV	DS DIVN. KOTKAPURA	DS S/U S/D KOTKAPURA	D437FL01	Kotkapura	AMR	OK	31.03.2023	Category 1				9568204	400-200/5	10.212	NA	Director/D	
B.11639	West	FARIDKOT	11KV	DS DIVN. KOTKAPURA	DS S/U S/D KOTKAPURA	D437FL03	Industrial	AMR	OK	31.03.2023	Category 4				9568214	900-450/577/1-1	16.673	NA	Director/D	
B.11640	West	FARIDKOT	11KV	DS DIVN. KOTKAPURA	DS S/U S/D KOTKAPURA	D478FL09	Jwanwala AP	AMR	OK	31.03.2023	AP 3Phase 3Wire				96715	900-450/577/1-1	1.673	NA	Director/D	
B.11641	West	FARIDKOT	11KV	DS S/U DIVN. MOGA	DS NORTH S/D MOGA	C409FL19	Jai Enterprises	AMR	OK	31.03.2023	Category 2				1.1111E+14	400-200/5	1.119	NA	Director/D	
B.11642	West	FARIDKOT	11KV	DS S/U DIVN. MOGA	DS NORTH S/D MOGA	C409FL09	Dhale Ke li	AMR	OK	31.03.2023	AP 3Phase 3Wire				8223501	1200-600/5	1.414	NA	Director/D	
B.11643	West	FARIDKOT	11KV	DS S/U DIVN. MOGA	DS NORTH S/D MOGA	C409FL13	Lande Ke AP	NON AMR	OK	31.03.2023	AP 3Phase 3Wire				8222845	400-200/5	1.549	NA	Director/D	
B.11644	West	FARIDKOT	11KV	DS S/U DIVN. MOGA	DS NORTH S/D MOGA	C409FL10	KHOSA SHEEDAN RURAL	NON AMR	OK	31.03.2023	AP 3Phase 3Wire				8222845	400-200/5	2.186	NA	Director/D	
B.11645	West	FARIDKOT	11KV	DS S/U DIVN. MOGA	DS NORTH S/D MOGA	C409FL16	SABIB SINGH WALA	AMR	OK	31.03.2023	AP 3Phase 3Wire				8222665	400-200/5	2.243	NA	Director/D	
B.11646	West	FARIDKOT	11KV	DS S/U DIVN. MOGA	DS NORTH S/D MOGA	C409FL11	BATTIAN II	AMR	OK	31.03.2023	AP 3Phase 3Wire				10281247	1200-600/5	2.265	NA	Director/D	
B.11647	West	FARIDKOT	11KV	DS S/U DIVN. MOGA	DS NORTH S/D MOGA	C409FL19	BATTIAN I	AMR	OK	31.03.2023	AP 3Phase 3Wire				8222819	1200-600/5	3.111	NA	Director/D	
B.11648	West	FARIDKOT	11KV	DS S/U DIVN. MOGA	DS NORTH S/D MOGA	C409FL04	KHOSA RURAL	AMR	OK	31.03.2023	AP 3Phase 3Wire				8222820	1200-600/5	3.248	NA	Director/D	
B.11649	West	FARIDKOT	11KV	DS S/U DIVN. MOGA	DS NORTH S/D MOGA	C409FL05	DHALLE KE RURAL	NON AMR	OK	31.03.2023	AP 3Phase 3Wire				8223502	400-200/5	6.031	NA	Director/D	
B.11650	West	FARIDKOT	11KV	DS S/U DIVN. MOGA	DS NORTH S/D MOGA	C409FL18	Battian Urban	NON AMR	OK	31.03.2023	Category 5-UPS				10281217	400-200/5	6.251	NA	Director/D	
B.11651	West	FARIDKOT	11KV	DS S/U DIVN. MOGA	DS NORTH S/D MOGA	C409FL17	Guru Ram Dass Nagar	AMR	OK	31.03.2023	Category 1				13190543	400-200/5	7.469	NA	Director/D	
B.11652	West	FARIDKOT	11KV	DS S/U DIVN. MOGA	DS NORTH S/D MOGA	C409FL12	Jandekia Urban	AMR	OK	31.03.2023	Category 5-UPS				9568290	1200-600/5	12.514	NA	Director/D	
B.11653	West	FARIDKOT	11KV	DS S/U DIVN. MOGA	DS NORTH S/D MOGA	C409FL03	INDUSTRIAL	AMR	OK	31.03.2023	Category 1				9568098	1200-600/5	8.960	NA	Director/D	
B.11654	West	FARIDKOT	11KV	DS S/U DIVN. MOGA	DS NORTH S/D MOGA	C409FL02	SURAI NAGAR	AMR	OK	31.03.2023	Category 1				9568182	1200-600/5	9.001	NA	Director/D	
B.11655	West	FARIDKOT	11KV	DS S/U DIVN. MOGA	DS NORTH S/D MOGA	C409FL07	FACTORY AREA	AMR	OK	31.03.2023	Category 2				9568263	1200-600/5	14.597	NA	Director/D	
B.11656	West	FARIDKOT	11KV	DS S/U DIVN. MOGA	DS NORTH S/D MOGA	C408FL07	COLONY	AMR	OK	31.03.2023	Category 1				9568095	1200-600/5	0.184	NA	Director/D	
B.11657	West	FARIDKOT	11KV	DS S/U DIVN. MOGA	DS NORTH S/D MOGA	C409FL14	LOHARA RURAL	AMR	OK	31.03.2023	AP 3Phase 3Wire				8223204	1200-600/5	2.023	NA	Director/D	
B.11658	West	FARIDKOT	11KV	DS S/U DIVN. MOGA	DS NORTH S/D MOGA	C408FL08	AMRITASAR ROAD URBAN	AMR	OK	31.03.2023	Category 5-UPS				9568248	1200-600/5	6.455	NA	Director/D	
B.11659	West	FARIDKOT	11KV	DS S/U DIVN. MOGA	DS NORTH S/D MOGA	C408FL03	Zira Road	AMR	OK	31.03.2023	Category 1				9568101	1200-600/5	8.353	NA	Director/D	
B.11660	West	FARIDKOT	11KV	DS S/U DIVN. MOGA	DS NORTH S/D MOGA	C408FL18	SAHIBZADA AJIT SINGH NAGAR	AMR	OK	31.03.2023	Category 1				11111111	1200-600/5	8.639	NA	Director/D	
B.11661	West	FARIDKOT	11KV	DS S/U DIVN. MOGA	DS NORTH S/D MOGA	C408FL04	Durti Road	AMR	OK	31.03.2023	Category 1				9568107	1200-600/5	9.825	NA	Director/D	
B.11662	West	FARIDKOT	11KV	DS S/U DIVN. MOGA	DS NORTH S/D MOGA	C408FL14	AKALSAR	AMR	OK	31.03.2023	Category 1				9568228	1200-600/5	11.658	NA	Director/D	
B.11663	West	FARIDKOT	11KV	DS S/U DIVN. MOGA	DS NORTH S/D MOGA	C408FL09	KI URBAN	AMR	OK	31.03.2023	Category 1				9568290	1200-600/5	12.514	NA	Director/D	
B.11664	West	FARIDKOT	11KV	DS S/U DIVN. MOGA	DS NORTH S/D MOGA	I404FL05	ITI	Not available	ITI						9568213	1200/577/1-1	12.115	NA	Director/D	
B.11665	West	FARIDKOT	66KV	DS S/U DIVN. MOGA	DS NORTH S/D MOGA	C408DL03	66 KV NESTLE	AMR	OK	31.03.2023	Category 4				Not available	Not available	40.962	NA	Director/D	
B.11666	West	FARIDKOT	11KV	DS S/U DIVN. MOGA	DS S/D AJITWAL	D058FL03	DADHURJ	AMR	OK	31.03.2023	AP 3Phase 3Wire				36956	1200-600/5	1.873	NA	Director/D	
B.11667	West	FARIDKOT	11KV	DS S/U DIVN. MOGA	DS S/D AJITWAL	D427FL01														

S.No	Zone	Circle	Voltage Level (kVA)	Division (kVA)	Sub-Division (kVA)	Feeder ID	Feeder Name	Feeder Metering Status (Metered/unmetered/AMR/AMI)	Status of Meter (Functional/Non-Functional)	Metering Date (Date of last actual meter reading/communication)	Feeder Type (Agr/Industrial/Mixed)	Status of Communication			Period from 01.04.2021 to 31.03.2022				Sales	Remarks (Source of data)
												% Data received through automatically if feeder AMR/AMI	Number of hours when meter was unable to communicate in week	Total Number of hours in the period	Meter S.No	CT/Ratio	Import (kWh)	Export (kWh)		
B.11707	West	FARIDKOT	11KV	DS S/U DIVN. MOGA	DS S/D BADHNIKALAN	C411FL09	BIR BADHNI no 1 +bir badhni no2	AMR	OK	31.03.2023	AP 3Phase 3Wire				8223064	1200-600/5	5.174	NA	Director/D	
B.11708	West	FARIDKOT	11KV	DS S/U DIVN. MOGA	DS S/D BADHNIKALAN	C411FL22	Ranjan UPS	AMR	OK	31.03.2023	Category 5-UPS				11111111	900-450/5	5.321	NA	Director/D	
B.11709	West	FARIDKOT	11KV	DS S/U DIVN. MOGA	DS S/D BADHNIKALAN	C411FL16	MINIAN 18, MINIAN 3	AMR	OK	31.03.2023	AP 3Phase 3Wire				8222514	1200-600/5	5.468	NA	Director/D	
B.11710	West	FARIDKOT	11KV	DS S/U DIVN. MOGA	DS S/D BADHNIKALAN	C411FL15	BITTAR UPS	NON AMR	OK	31.03.2023	Category 5-UPS				2067165	1200-600/5	11.857	NA	Director/D	
B.11711	West	FARIDKOT	11KV	DS S/U DIVN. MOGA	DS S/D BADHNIKALAN	C411FL10	LOPON UPS	AMR	OK	31.03.2023	Category 5-UPS				2067744	900-450/5	13.718	NA	Director/D	
B.11712	West	FARIDKOT	11KV	DS S/U DIVN. MOGA	DS S/D BADHNIKALAN	C411FL02	CADHNI KALAN	AMR	OK	31.03.2023	Category 1				9154386	900-450/5	17.376	NA	Director/D	
B.11713	West	FARIDKOT	11KV	DS S/U DIVN. MOGA	DS S/D BADHNIKALAN	4434FL13	KUTIA ROAD	AMR	OK	31.03.2023	AP 3Phase 3Wire				11111111	900-450/5/77/1-1	1.088	NA	Director/D	
B.11714	West	FARIDKOT	11KV	DS S/U DIVN. MOGA	DS S/D BADHNIKALAN	0434FL12	RAMUWALA	AMR	OK	31.03.2023	AP 3Phase 3Wire				9141050	Not installed	1.478	NA	Director/D	
B.11715	West	FARIDKOT	11KV	DS S/U DIVN. MOGA	DS S/D BADHNIKALAN	0434FL04	DHURKOT NEW	AMR	OK	31.03.2023	AP 3Phase 3Wire				11111111	Not installed	1.468	NA	Director/D	
B.11716	West	FARIDKOT	11KV	DS S/U DIVN. MOGA	DS S/D BADHNIKALAN	0434D0	DHAK WALA DALA	AMR	OK	31.03.2023	AP 3Phase 3Wire				8222576	900-450/5/77/1-1	1.562	NA	Director/D	
B.11717	West	FARIDKOT	11KV	DS S/U DIVN. MOGA	DS S/D BADHNIKALAN	0434FL10	DALA RURAL	NON AMR	OK	31.03.2023	AP 3Phase 3Wire				8222579	900-450/5/77/1-1	1.692	NA	Director/D	
B.11718	West	FARIDKOT	11KV	DS S/U DIVN. MOGA	DS S/D BADHNIKALAN	0434FL09	SADOMNIANA	AMR	OK	31.03.2023	AP 3Phase 3Wire				8222576	Not installed	2.005	NA	Director/D	
B.11719	West	FARIDKOT	11KV	DS S/U DIVN. MOGA	DS S/D BADHNIKALAN	0434FL18	MADDOKE ROAD	AMR	OK	31.03.2023	AP 3Phase 3Wire				9141048	900-450/5/77/1-1	2.075	NA	Director/D	
B.11720	West	FARIDKOT	11KV	DS S/U DIVN. MOGA	DS S/D BADHNIKALAN	0434FL19	buttar khurd road	AMR	OK	31.03.2023	AP 3Phase 3Wire				11111111	Not installed	2.169	NA	Director/D	
B.11721	West	FARIDKOT	11KV	DS S/U DIVN. MOGA	DS S/D BADHNIKALAN	0434FL16	TREHVALA	AMR	OK	31.03.2023	AP 3Phase 3Wire				1111287	900-450/5/77/1-1	2.174	NA	Director/D	
B.11722	West	FARIDKOT	11KV	DS S/U DIVN. MOGA	DS S/D BADHNIKALAN	0434FL08	BHAI BALA	AMR	OK	31.03.2023	AP 3Phase 3Wire				4221142	Not installed	2.356	NA	Director/D	
B.11723	West	FARIDKOT	11KV	DS S/U DIVN. MOGA	DS S/D BADHNIKALAN	0434FL07	TAKHANWADH	AMR	OK	31.03.2023	AP 3Phase 3Wire				8222572	900-450/5/77/1-1	2.567	NA	Director/D	
B.11724	West	FARIDKOT	11KV	DS S/U DIVN. MOGA	DS S/D BADHNIKALAN	0434FL03	BHASIANA	AMR	OK	31.03.2023	AP 3Phase 3Wire				9141046	Not installed	2.705	NA	Director/D	
B.11725	West	FARIDKOT	11KV	DS S/U DIVN. MOGA	DS S/D BADHNIKALAN	0434M06	JHANDIANA ROADS	AMR	OK	31.03.2023	Category 5-UPS				11111111	900-450/5/77/1-1	2.897	NA	Director/D	
B.11726	West	FARIDKOT	11KV	DS S/U DIVN. MOGA	DS S/D BADHNIKALAN	0434FL15	RANJA ROAD BITTAR	AMR	OK	31.03.2023	AP 3Phase 3Wire				9141040	Not installed	2.976	NA	Director/D	
B.11727	West	FARIDKOT	11KV	DS S/U DIVN. MOGA	DS S/D BADHNIKALAN	0434FL17	TAKHANWADH	AMR	OK	31.03.2023	Category 5-UPS				9141040	Not installed	2.752	NA	Director/D	
B.11728	West	FARIDKOT	11KV	DS S/U DIVN. MOGA	DS S/D BADHNIKALAN	0434FL06	MOGA ROAD UPS	AMR	OK	31.03.2023	Category 5-UPS				8222577	900-450/5/77/1-1	10.568	NA	Director/D	
B.11729	West	FARIDKOT	11KV	DS S/U DIVN. MOGA	DS S/D BADHNIKALAN	0444FL07	BITTAR 3P	AMR	OK	31.03.2023	AP 3Phase 3Wire				73130097	900-450/5/77/1-1	2.752	NA	Director/D	
B.11730	West	FARIDKOT	11KV	DS S/U DIVN. MOGA	DS S/D BADHNIKALAN	0424FL06	BHUSAN WALA	AMR	OK	31.03.2023	AP 3Phase 3Wire				8222740	400-200/5-5	2.131	NA	Director/D	
B.11731	West	FARIDKOT	11KV	DS S/U DIVN. MOGA	DS S/D BADHNIKALAN	0424FL10	DEKA BRASHIN	AMR	OK	31.03.2023	AP 3Phase 3Wire				2824	900-450/5/77/1-1	2.318	NA	Director/D	
B.11732	West	FARIDKOT	11KV	DS S/U DIVN. MOGA	DS S/D BADHNIKALAN	0424G01	GHOLIA ROAD	AMR	OK	31.03.2023	AP 3Phase 3Wire				2832	900-450/5/77/1-1	2.415	NA	Director/D	
B.11733	West	FARIDKOT	11KV	DS S/U DIVN. MOGA	DS S/D BADHNIKALAN	0424FL13	BIR RAUKE UPS	AMR	OK	31.03.2023	Category 5-UPS				2813	900-450/5/77/1-1	2.445	NA	Director/D	
B.11734	West	FARIDKOT	11KV	DS S/U DIVN. MOGA	DS S/D BADHNIKALAN	0424FL03	RANJA ROAD RAUKE	AMR	OK	31.03.2023	AP 3Phase 3Wire				8222921	400-200/5-5	2.574	NA	Director/D	
B.11735	West	FARIDKOT	11KV	DS S/U DIVN. MOGA	DS S/D BADHNIKALAN	0424FL04	JAWAHAR SINGH WALA ROAD	AMR	OK	31.03.2023	AP 3Phase 3Wire				8222669	400-200/5-5	2.595	NA	Director/D	
B.11736	West	FARIDKOT	11KV	DS S/U DIVN. MOGA	DS S/D BADHNIKALAN	0424FL12	MANUKE ROAD	AMR	OK	31.03.2023	AP 3Phase 3Wire				3112	900-450/5/77/1-1	2.652	NA	Director/D	
B.11737	West	FARIDKOT	11KV	DS S/U DIVN. MOGA	DS S/D BADHNIKALAN	0424FL01	BIR RAUKE RAUKE GRID	AMR	OK	31.03.2023	AP 3Phase 3Wire				8222739	400-200/5-5	2.688	NA	Director/D	
B.11738	West	FARIDKOT	11KV	DS S/U DIVN. MOGA	DS S/D BADHNIKALAN	0424FL05	BIR BADHNI RAUKE GRID	AMR	OK	31.03.2023	Category 5-UPS				8222743	400-200/5-5	3.194	NA	Director/D	
B.11739	West	FARIDKOT	11KV	DS S/U DIVN. MOGA	DS S/D BADHNIKALAN	0424FL02	RAUKE KALAN URBAN	AMR	OK	31.03.2023	Category 5-UPS				7042990	400-200/5-5	7.303	NA	Director/D	
B.11740	West	FARIDKOT	11KV	DS S/U DIVN. MOGA	DS S/D CHARIK	C411FL04	RANIAN I	AMR	OK	31.03.2023	AP 3Phase 3Wire				2047122	900-450/5	3.829	NA	Director/D	
B.11741	West	FARIDKOT	11KV	DS S/U DIVN. MOGA	DS S/D CHARIK	C411FL08	RANIAN 2 &3	AMR	OK	31.03.2023	AP 3Phase 3Wire				8223310	1200-600/5	5.074	NA	Director/D	
B.11742	West	FARIDKOT	11KV	DS S/U DIVN. MOGA	DS S/D CHARIK	0413FL11	BUDHSINGH WALA	NON AMR	OK	31.03.2023	AP 3Phase 3Wire				8222679	900-450/5	0.000	NA	Director/D	
B.11743	West	FARIDKOT	11KV	DS S/U DIVN. MOGA	DS S/D CHARIK	0413FL03	BABA JAKHMAN SINGH UPS	NON AMR	OK	31.03.2023	Category 5-UPS				6761910	900-450/5	0.010	NA	Director/D	
B.11744	West	FARIDKOT	11KV	DS S/U DIVN. MOGA	DS S/D CHARIK	0413FL02	BABA KHUSHAL SINGH I	AMR	OK	31.03.2023	AP 3Phase 3Wire				9141072	900-450/5/77/1-1	1.337	NA	Director/D	
B.11745	West	FARIDKOT	11KV	DS S/U DIVN. MOGA	DS S/D CHARIK	0413FL19	Baba Khushal Singh II	NON AMR	OK	31.03.2023	AP 3Phase 3Wire				8223110	900-450/5/77/1-1	1.435	NA	Director/D	
B.11746	West	FARIDKOT	11KV	DS S/U DIVN. MOGA	DS S/D CHARIK	0413FL10	MALLIAN WALA	NON AMR	OK	31.03.2023	AP 3Phase 3Wire				8222677	900-450/5/77/1-1	1.469	NA	Director/D	
B.11747	West	FARIDKOT	11KV	DS S/U DIVN. MOGA	DS S/D CHARIK	0413FL01	KOTHE JAITO KE II	AMR	OK	31.03.2023	AP 3Phase 3Wire				8223110	900-450/5	1.517	NA	Director/D	
B.11748	West	FARIDKOT	11KV	DS S/U DIVN. MOGA	DS S/D CHARIK	0413FL13	BURI RUNA	NON AMR	OK	31.03.2023	AP 3Phase 3Wire				8222678	900-450/5/77/1-1	1.586	NA	Director/D	
B.11749	West	FARIDKOT	11KV	DS S/U DIVN. MOGA	DS S/D CHARIK	0413FL15	Phul Donr	NON AMR	OK	31.03.2023	AP 3Phase 3Wire				1111	900-450/5	1.717	NA	Director/D	
B.11750	West	FARIDKOT	11KV	DS S/U DIVN. MOGA	DS S/D CHARIK	0413FL12	CHUPKITI	NON AMR	OK	31.03.2023	AP 3Phase 3Wire				2067317	900-450/5/77/1-1	1.746	NA	Director/D	
B.11751	West	FARIDKOT	11KV	DS S/U DIVN. MOGA	DS S/D CHARIK	0413FL17	CHUP KITI I	AMR	OK	31.03.2023	AP 3Phase 3Wire				485965	900-450/5	1.998	NA	Director/D	
B.11752	West	FARIDKOT	11KV	DS S/U DIVN. MOGA	DS S/D CHARIK	0413FL18	MALLIAN WALA II	NON AMR	OK	31.03.2023	AP 3Phase 3Wire				1658447	900-450/5	2.037	NA	Director/D	
B.11753	West	FARIDKOT	11KV	DS S/U DIVN. MOGA	DS S/D CHARIK	0413FL07	KOTHE GINDU KE	AMR	OK	31.03.2023	AP 3Phase 3Wire				8223450	900-450/5	2.100	NA	Director/D	
B.11754	West	FARIDKOT	11KV	DS S/U DIVN. MOGA	DS S/D CHARIK	0413FL20	Dhara Rast	AMR	OK	31.03.2023	AP 3Phase 3Wire				9141916	900-450/5/77/1-1	2.316	NA	Director/D	
B.11755	West	FARIDKOT	11KV	DS S/U DIVN. MOGA	DS S/D CHARIK	0413FL09	KOTHE LIGGOU KE	AMR	OK	31.03.2023	AP 3Phase 3Wire				8222676	900-450/5	2.322	NA	Director/D	
B.11756	West	FARIDKOT	11KV	DS S/U DIVN. MOGA	DS S/D CHARIK	0413FL08	BHONA	NON AMR	OK	31.03.2023	AP 3Phase 3Wire				8223449	900-450/5/77/1-1	2.376	NA	Director/D	
B.11757	West	FARIDKOT	11KV	DS S/U DIVN. MOGA	DS S/D CHARIK	0413FL05	MEHARON RURAL	NON AMR	OK	31.03.2023	AP 3Phase 3Wire				8223109	900-450/5	3.322	NA	Director/D	
B.11758	West	FARIDKOT	11KV	DS S/U DIVN. MOGA	DS S/D CHARIK	0413FL06	JHANDEWALA	AMR	OK	31.03.2023	AP 3Phase 3Wire				8223308	900-450/5	5.137	NA	Director/D	
B.11759	West	FARIDKOT	11KV	DS S/U DIVN. MOGA	DS S/D CHARIK	0413FL16	MEHARON II	NON AMR	OK	31.03.2023	AP 3Phase 3Wire				8223308	900-450/5	11.464	NA	Director/D	
B.11760	West	FARIDKOT	11KV	DS S/U DIVN. MOGA	DS S/D CHARIK	0413FL14	CHARIK URBAN	AMR	OK	31.03.2023	Category 5-UPS				2063715	900-450/5/77/1-1	11.497	NA	Director/D	
B.11761	West	FARIDKOT	11KV	DS S/U DIVN. MOGA	DS S/D CHARIK	0434FL11	MHRADON	AMR	OK	31.03.2023	AP 3Phase 3Wire				9141047	900-450/5/77/1-1	2.580	NA	Director/D	
B.11762	West	FARIDKOT	11KV	DS S/U DIVN. MOGA	DS S/D CHARIK	0434FL03	RAMUWALA KALAN	AMR	OK	31.03.2023	AP 3Phase 3Wire				10283032	900-450/5/77/1-1	1.358	NA	Director/D	
B.11763	West	FARIDKOT	11KV	DS S/U DIVN. MOGA	DS S/D CHARIK	0434FL04	DHURKOT TAHLI	AMR	OK	31.03.2023	AP 3Phase 3Wire				11111111	900-450/5/77/1-1				

S.No	Zone	Circle	Voltage Level (kVA)	Division (kVA)	Sub-Division (kVA)	Feeder ID	Feeder Name	Feeder Metering Status (Metered/unmetered/AMR/AMI)	Status of Meter (Functional/Non-functional)	Metering Date (Date of last actual meter reading/communication)	Feeder Type (Agr/Industrial/Mixed)	Status of Communication			Period from 01.04.2021 to 31.03.2022				Sales	Remarks (Source of data)
												% data received through automatically by feeder AMR/AMI	Number of hours when meter was unable to communicate in overall	Total Number of hours in the period	Meter S.No	CT/PT ratio	Import (kWh)	Export (kWh)		
B.11804	West	FEROZPUR	11kV	DS CITY DIVN. FEROZPUR	DS CANTT. NO-2 S/D FEROZPUR	E45F8L19	11 KV QUILA AP	AMR	OK	31.03.2023	AP 3Phase 3Wire				5232	1200-600/5	0.743	NA	Director/D	
B.11805	West	FEROZPUR	11kV	DS CITY DIVN. FEROZPUR	DS CANTT. NO-2 S/D FEROZPUR	E45F8L20	Fattu Wala (AP)	AMR	OK	31.03.2023	AP 3Phase 3Wire				4381	1200-600/5	2.120	NA	Director/D	
B.11806	West	FEROZPUR	11kV	DS CITY DIVN. FEROZPUR	DS CITY S/D FEROZPUR	E45F8L08	TARAP	AMR	OK	31.03.2023	AP 3Phase 3Wire				8223568	900-450/577/1-1	0.797	NA	Director/D	
B.11807	West	FEROZPUR	11kV	DS CITY DIVN. FEROZPUR	DS CITY S/D FEROZPUR	E45F8L03	SULTAN WALA	NON AMR	OK	31.03.2023	AP 3Phase 3Wire				771925	1000-500/577/1-1	0.882	NA	Director/D	
B.11808	West	FEROZPUR	11kV	DS CITY DIVN. FEROZPUR	DS CITY S/D FEROZPUR	E45F8L03	RAILWAY	NON AMR	OK	31.03.2023	Category 4				6675728	400-200/5-5	6.039	NA	Director/D	
B.11809	West	FEROZPUR	11kV	DS CITY DIVN. FEROZPUR	DS CITY S/D FEROZPUR	E45F8L01	BAGDADI GATE	AMR	OK	31.03.2023	Category 1				4119653	400-200/5-5	6.050	NA	Director/D	
B.11810	West	FEROZPUR	11kV	DS CITY DIVN. FEROZPUR	DS CITY S/D FEROZPUR	E45F8L08	ZILA PARISHAD	NON AMR	OK	31.03.2023	Category 1				117258	400-200/5-5	6.090	NA	Director/D	
B.11811	West	FEROZPUR	11kV	DS CITY DIVN. FEROZPUR	DS CITY S/D FEROZPUR	E45F8L10	11 kv Delhi Gate	AMR	OK	31.03.2023	Category 1				8223393	900-450/5	7.232	NA	Director/D	
B.11812	West	FEROZPUR	11kV	DS CITY DIVN. FEROZPUR	DS CITY S/D FEROZPUR	E45F8L11	Dhawan Colony	NON AMR	OK	31.03.2023	Category 1				36704	900-450/5	9.836	NA	Director/D	
B.11813	West	FEROZPUR	11kV	DS CITY DIVN. FEROZPUR	DS CITY S/D FEROZPUR	E45F8L09	CENTRAL HILL	NON AMR	OK	31.03.2023	Category 4				8223614	900-450/5	10.784	NA	Director/D	
B.11814	West	FEROZPUR	11kV	DS CITY DIVN. FEROZPUR	DS CITY S/D FEROZPUR	E45F8L01	SUB STATION	AMR	OK	31.03.2023	Category 4				2065240	900-450/5	0.031	NA	Director/D	
B.11815	West	FEROZPUR	11kV	DS CITY DIVN. FEROZPUR	DS CITY S/D FEROZPUR	E45F8L08	GILLAN WALA	AMR	OK	31.03.2023	AP 3Phase 3Wire				8222512	900-450/5	0.395	NA	Director/D	
B.11816	West	FEROZPUR	11kV	DS CITY DIVN. FEROZPUR	DS CITY S/D FEROZPUR	E45F8L06	BOP	AMR	OK	31.03.2023	Category 4				9568267	900-450/5	0.396	NA	Director/D	
B.11817	West	FEROZPUR	11kV	DS CITY DIVN. FEROZPUR	DS CITY S/D FEROZPUR	E45F8L03	BHADRU	AMR	OK	31.03.2023	AP 3Phase 3Wire				777148	900-450/5	1.565	NA	Director/D	
B.11818	West	FEROZPUR	11kV	DS CITY DIVN. FEROZPUR	DS CITY S/D FEROZPUR	E45F8L16	Bhagwanpura	NON AMR	OK	31.03.2023	AP 3Phase 3Wire				1474	900-450/5	1.904	NA	Director/D	
B.11819	West	FEROZPUR	11kV	DS CITY DIVN. FEROZPUR	DS CITY S/D FEROZPUR	E45F8L15	Bhamba Singh Wala	AMR	OK	31.03.2023	AP 3Phase 3Wire				37021	900-450/5	1.917	NA	Director/D	
B.11820	West	FEROZPUR	11kV	DS CITY DIVN. FEROZPUR	DS CITY S/D FEROZPUR	E45F8L12	11 KV Bhagat Singh College	AMR	OK	31.03.2023	Category 1				11117217	900-450/5	1.928	NA	Director/D	
B.11821	West	FEROZPUR	11kV	DS CITY DIVN. FEROZPUR	DS CITY S/D FEROZPUR	E45F8L04	PALLA MEGHA	AMR	OK	31.03.2023	AP 3Phase 3Wire				8222564	900-450/5	1.943	NA	Director/D	
B.11822	West	FEROZPUR	11kV	DS CITY DIVN. FEROZPUR	DS CITY S/D FEROZPUR	E45F8L09	Dulich Ke	NON AMR	OK	31.03.2023	AP 3Phase 3Wire				777570	900-450/5	1.948	NA	Director/D	
B.11823	West	FEROZPUR	11kV	DS CITY DIVN. FEROZPUR	DS CITY S/D FEROZPUR	E45F8L14	Rame Wala	AMR	OK	31.03.2023	AP 3Phase 3Wire				9568331	900-450/5	2.317	NA	Director/D	
B.11824	West	FEROZPUR	11kV	DS CITY DIVN. FEROZPUR	DS CITY S/D FEROZPUR	E45F8L11	HAKE WALA	AMR	OK	31.03.2023	Category 5-UPS				6607240	900-450/5	2.493	NA	Director/D	
B.11825	West	FEROZPUR	11kV	DS CITY DIVN. FEROZPUR	DS CITY S/D FEROZPUR	E45F8L17	Bahadar Wala	AMR	OK	31.03.2023	Category 5-UPS				1415	900-450/5	8.892	NA	Director/D	
B.11826	West	FEROZPUR	11kV	DS CITY DIVN. FEROZPUR	DS CITY S/D FEROZPUR	E45F8L02	Makhu Gate	AMR	OK	31.03.2023	Category 1				7336725	900-450/5	9.015	NA	Director/D	
B.11827	West	FEROZPUR	11kV	DS CITY DIVN. FEROZPUR	DS CITY S/D FEROZPUR	E45F8L10	DANA MANDI	NON AMR	OK	31.03.2023	Category 1				9141093	900-450/5	9.624	NA	Director/D	
B.11828	West	FEROZPUR	11kV	DS CITY DIVN. FEROZPUR	DS CITY S/D FEROZPUR	E45F8L18	Gobar Mandi	AMR	OK	31.03.2023	Category 1				16199631	900-450/5	10.734	NA	Director/D	
B.11829	West	FEROZPUR	11kV	DS CITY DIVN. FEROZPUR	DS CITY S/D FEROZPUR	E45F8L07	POLYTECHNIC COLLEGE	NON AMR	OK	31.03.2023	Category 1				2046989	900-450/5	10.904	NA	Director/D	
B.11830	West	FEROZPUR	11kV	DS CITY DIVN. FEROZPUR	DS CITY S/D FEROZPUR	E45F8L13	City Enclave	AMR	OK	31.03.2023	Category 1				33831	900-450/5	11.322	NA	Director/D	
B.11831	West	FEROZPUR	11kV	DS CITY DIVN. FEROZPUR	DS CITY S/D FEROZPUR	E45F8L05	SODHE WALA	AMR	OK	31.03.2023	Category 5-UPS				8233721	900-450/5	15.992	NA	Director/D	
B.11832	West	FEROZPUR	11kV	DS CITY DIVN. FEROZPUR	DS CITY S/D FEROZPUR	E45F8L05	Sub Station	AMR	OK	31.03.2023	Category 1				12092500	900-450/577/1-1	0.007	NA	Director/D	
B.11833	West	FEROZPUR	11kV	DS CITY DIVN. FEROZPUR	DS CITY S/D FEROZPUR	E45F8L11	BASTI ISSE WALI	NON AMR	OK	31.03.2023	AP 3Phase 3Wire				4639	900-450/577/1-1	0.112	NA	Director/D	
B.11834	West	FEROZPUR	11kV	DS CITY DIVN. FEROZPUR	DS CITY S/D FEROZPUR	E45F8L02	Akhu Wala	NON AMR	OK	31.03.2023	AP 3Phase 3Wire				12092412	900-450/577/1-1	1.141	NA	Director/D	
B.11835	West	FEROZPUR	11kV	DS CITY DIVN. FEROZPUR	DS CITY S/D FEROZPUR	E45F8L03	Basit Ram Lal	AMR	OK	31.03.2023	AP 3Phase 3Wire				12092495	900-450/577/1-1	1.187	NA	Director/D	
B.11836	West	FEROZPUR	11kV	DS CITY DIVN. FEROZPUR	DS CITY S/D FEROZPUR	E45F8L10	Basit Khan Ke AP	AMR	OK	31.03.2023	AP 3Phase 3Wire				5365	900-450/577/1-1	1.250	NA	Director/D	
B.11837	West	FEROZPUR	11kV	DS CITY DIVN. FEROZPUR	DS CITY S/D FEROZPUR	E45F8L09	NIZAMWALA AP	NON AMR	OK	31.03.2023	AP 3Phase 3Wire				12092499	900-450/577/1-1	1.503	NA	Director/D	
B.11838	West	FEROZPUR	11kV	DS CITY DIVN. FEROZPUR	DS CITY S/D FEROZPUR	E45F8L06	Attari Urban	NON AMR	OK	31.03.2023	Category 1				23499	900-450/577/1-1	1.650	NA	Director/D	
B.11839	West	FEROZPUR	11kV	DS CITY DIVN. FEROZPUR	DS CITY S/D FEROZPUR	E45F8L04	Mahalan	AMR	OK	31.03.2023	AP 3Phase 3Wire				12092504	900-450/577/1-1	1.764	NA	Director/D	
B.11840	West	FEROZPUR	11kV	DS CITY DIVN. FEROZPUR	DS CITY S/D FEROZPUR	E45F8L07	Wadhwa Wala AP	AMR	OK	31.03.2023	AP 3Phase 3Wire				32358	900-450/577/1-1	1.795	NA	Director/D	
B.11841	West	FEROZPUR	11kV	DS CITY DIVN. FEROZPUR	DS CITY S/D FEROZPUR	E45F8L08	Kamal Wala AP	AMR	OK	31.03.2023	AP 3Phase 3Wire				73171256	900-450/577/1-1	1.826	NA	Director/D	
B.11842	West	FEROZPUR	11kV	DS CITY DIVN. FEROZPUR	DS CITY S/D FEROZPUR	E45F8L01	Katora (UPS)	AMR	OK	31.03.2023	Category 5-UPS				5369	900-450/577/1-1	10.043	NA	Director/D	
B.11843	West	FEROZPUR	11kV	DS CITY DIVN. FEROZPUR	DS S/D FEROZESHAH	C451F103	SARAN WALI	AMR	OK	31.03.2023	AP 3Phase 3Wire				6669345	1200-600/5	0.000	NA	Director/D	
B.11844	West	FEROZPUR	11kV	DS CITY DIVN. FEROZPUR	DS S/D FEROZESHAH	C451F107	MANE WALA	AMR	OK	31.03.2023	AP 3Phase 3Wire				8223570	1200-600/5	0.000	NA	Director/D	
B.11845	West	FEROZPUR	11kV	DS CITY DIVN. FEROZPUR	DS S/D FEROZESHAH	C451F101	DHINDSA	AMR	OK	31.03.2023	AP 3Phase 3Wire				8223569	900-450/577/1-1	1.850	NA	Director/D	
B.11846	West	FEROZPUR	11kV	DS CITY DIVN. FEROZPUR	DS S/D FEROZESHAH	C451F109	Rulghani	AMR	OK	31.03.2023	AP 3Phase 3Wire				8223334	1200-600/5	2.149	NA	Director/D	
B.11847	West	FEROZPUR	11kV	DS CITY DIVN. FEROZPUR	DS S/D FEROZESHAH	C451F104	KALIE WALA	AMR	OK	31.03.2023	AP 3Phase 3Wire				8223333	900-450/577/1-1	2.289	NA	Director/D	
B.11848	West	FEROZPUR	11kV	DS CITY DIVN. FEROZPUR	DS S/D FEROZESHAH	C45F8L02	Bhamba Landaa	AMR	OK	31.03.2023	AP 3Phase 3Wire				6489693	900-450/577/1-1	2.334	NA	Director/D	
B.11849	West	FEROZPUR	11kV	DS CITY DIVN. FEROZPUR	DS S/D FEROZESHAH	C45F8L12	MOHKAM WALA	NON AMR	OK	31.03.2023	AP 3Phase 3Wire				8223335	1200-600/5	2.423	NA	Director/D	
B.11850	West	FEROZPUR	11kV	DS CITY DIVN. FEROZPUR	DS S/D FEROZESHAH	C45F8L05	Ratta Kherra	AMR	OK	31.03.2023	AP 3Phase 3Wire				4211190	1200-600/5	2.767	NA	Director/D	
B.11851	West	FEROZPUR	11kV	DS CITY DIVN. FEROZPUR	DS S/D FEROZESHAH	C45F8L14	FEROZESHAH	AMR	OK	31.03.2023	Category 5-UPS				2067670	900-450/577/1-1	3.805	NA	Director/D	
B.11852	West	FEROZPUR	11kV	DS CITY DIVN. FEROZPUR	DS S/D FEROZESHAH	C45F8L13	LOHAM	NON AMR	OK	31.03.2023	Category 5-UPS				778201	1200-600/5	1.850	NA	Director/D	
B.11853	West	FEROZPUR	11kV	DS CITY DIVN. FEROZPUR	DS S/D FEROZESHAH	C45F8L16	WANDRA BHAR UPS	AMR	OK	31.03.2023	Category 5-UPS				4698	1200-600/5	4.569	NA	Director/D	
B.11854	West	FEROZPUR	11kV	DS CITY DIVN. FEROZPUR	DS S/D FEROZESHAH	C451F102	Mishri Wala	AMR	OK	31.03.2023	Category 5-UPS				8223335	900-450/577/1-1	5.205	NA	Director/D	
B.11855	West	FEROZPUR	11kV	DS CITY DIVN. FEROZPUR	DS S/D FEROZESHAH	C451F106	SODHI NAGAR	AMR	OK	31.03.2023	Category 5-UPS				1956064	900-450/577/1-1	5.478	NA	Director/D	
B.11856	West	FEROZPUR	11kV	DS CITY DIVN. FEROZPUR	DS S/D FEROZESHAH	C451F115	Shurajadi	AMR	OK	31.03.2023	Category 5-UPS				11069740	1200-600/5	6.631	NA	Director/D	
B.11857	West	FEROZPUR	11kV	DS CITY DIVN. FEROZPUR	DS S/D FEROZESHAH	C45F8L05	CHAND MARIAN	AMR	OK	31.03.2023	AP 3Phase 3Wire				2994123	900-450/5	6.074	NA	Director/D	
B.11858	West	FEROZPUR	11kV	DS CITY DIVN. FEROZPUR	DS S/D FEROZESHAH	C45F8L04	SAPPAN WALA	AMR	OK	31.03.2023	AP 3Phase 3Wire				8223134	900-450/577/1-1	1.313	NA	Director/D	
B.11859	West	FEROZPUR	11kV	DS CITY DIVN. FEROZPUR	DS S/D FEROZESHAH	C45F8L06	BAIE WALA	AMR	OK	31.03.2023	AP 3Phase 3Wire				8223133	900-450/577/1-1	1.717	NA	Director/D	
B.11860	West	FEROZPUR	11kV	DS CITY DIVN. FEROZPUR	DS S/D FEROZESHAH	C45F8L13	RATTA KHERA	AMR	OK	31.03.2023	AP 3Phase 3Wire				8223135	90				

S.No	Zone	Circle	Voltage Level (kVA)	Division (kVA)	Sub-Division (kVA)	Feeder ID	Feeder Name	Feeder Metering Status (Metered/unmetered/AMR/AMI)	Status of Meter (Functional/Non-functional)	Metering Date	Date of last actual meter reading/communication	Feeder Type (Agr/Industrial/Mixed)	Status of Communication			Period from 01.04.2021 to 31.03.2022				Sales	Remarks (Source of data)
													% data received through automatically if feeder AMR/AMI	Number of hours when meter was unable to communicate in overall	Total Number of hours in the period	Meter S.No	CT/PT ratio	Import (kWh)	Export (kWh)		
B.11901	West	FEROZPUR	11KV	DS CITY DIVN. FEROZPUR	DS S/D SHER KHAN	E453FL02	CHANGALI	AMR	OK	31.03.2023		AP 3Phase 3Wire				11117314	1000-500/577/1-1-1	1.464	NA	Director/D	
B.11902	West	FEROZPUR	11KV	DS CITY DIVN. FEROZPUR	DS S/D SHER KHAN	E453FL05	VALOOR	AMR	OK	31.03.2023		AP 3Phase 3Wire				8223812	1000-500/577/1-1-1	1.857	NA	Director/D	
B.11903	West	FEROZPUR	11KV	DS CITY DIVN. FEROZPUR	DS S/D SHER KHAN	E453FL01	SHER KHAN	AMR	OK	31.03.2023		AP 3Phase 3Wire				77734	1000-500/577/1-1-1	1.813	NA	Director/D	
B.11904	West	FEROZPUR	11KV	DS CITY DIVN. FEROZPUR	DS S/D SHER KHAN	E453FL04	SUR SINGH WALA	NON AMR	OK	31.03.2023		AP 3Phase 3Wire				9568136	1000-500/577/1-1-1	2.508	NA	Director/D	
B.11905	West	FEROZPUR	11KV	DS CITY DIVN. FEROZPUR	DS S/D SHER KHAN	E453FL11	Sainpura (UPS)	AMR	OK	31.03.2023		Category 5-UPS				9390826	900-450/577/1-1-1	9.527	NA	Director/D	
B.11906	West	FEROZPUR	11KV	DS CITY DIVN. FEROZPUR	DS S/D SHER KHAN	E453FL08	HARI PURA	AMR	OK	31.03.2023		AP 3Phase 3Wire				8223567	900-450/577/1-1-1	1.143	NA	Director/D	
B.11907	West	FEROZPUR	11KV	DS CITY DIVN. FEROZPUR	DS S/D SHER KHAN	E453FL05	Kaku wala	AMR	OK	31.03.2023		AP 3Phase 3Wire				4179719	900-450/577/1-1-1	1.204	NA	Director/D	
B.11908	West	FEROZPUR	11KV	DS CITY DIVN. FEROZPUR	DS S/D SHER KHAN	E453FL12	Sandhu Hasham	AMR	OK	31.03.2023		AP 3Phase 3Wire				15193704	900-450/577/1-1-1	1.486	NA	Director/D	
B.11909	West	FEROZPUR	11KV	DS CITY DIVN. FEROZPUR	DS S/D SHER KHAN	F1144541	Tarpur	AMR	OK	31.03.2023		AP 3Phase 3Wire				16194409	900-450/577/1-1-1	1.270	NA	Director/D	
B.11910	West	FEROZPUR	11KV	DS CITY DIVN. FEROZPUR	DS S/D SHER KHAN	E453FL13	Nandu Wala	AMR	OK	31.03.2023		AP 3Phase 3Wire				8223567	900-450/577/1-1-1	1.616	NA	Director/D	
B.11911	West	FEROZPUR	11KV	DS CITY DIVN. FEROZPUR	DS S/D SHER KHAN	E453FL02	Loombri Wala	AMR	OK	31.03.2023		AP 3Phase 3Wire				8223566	900-450/577/1-1-1	1.667	NA	Director/D	
B.11912	West	FEROZPUR	11KV	DS CITY DIVN. FEROZPUR	DS S/D SHER KHAN	E453FL04	Bagee ke	AMR	OK	31.03.2023		AP 3Phase 3Wire				7336501	900-450/577/1-1-1	1.797	NA	Director/D	
B.11913	West	FEROZPUR	11KV	DS CITY DIVN. FEROZPUR	DS S/D SHER KHAN	E453FL09	GURU NANAK NAGAR	AMR	OK	31.03.2023		AP 3Phase 3Wire				2065854	900-450/577/1-1-1	1.872	NA	Director/D	
B.11914	West	FEROZPUR	11KV	DS CITY DIVN. FEROZPUR	DS S/D SHER KHAN	E453FL01	Jamitpur Dhruu	AMR	OK	31.03.2023		AP 3Phase 3Wire				6486405	900-450/577/1-1-1	2.065	NA	Director/D	
B.11915	West	FEROZPUR	11KV	DS CITY DIVN. FEROZPUR	DS S/D SHER KHAN	E453FL05	HASTI WALA	AMR	OK	31.03.2023		Category 5-UPS				5981	900-450/577/1-1-1	2.415	NA	Director/D	
B.11916	West	FEROZPUR	11KV	DS CITY DIVN. FEROZPUR	DS S/D SHER KHAN	E453FL03	Urbanj	AMR	OK	31.03.2023		Category 2				3322	900-450/577/1-1-1	6.882	NA	Director/D	
B.11917	West	FEROZPUR	11KV	DS CITY DIVN. FEROZPUR	DS S/D SHER KHAN	E453FL07	Nazu Shah Wala	AMR	OK	31.03.2023		Category 5-UPS				5342478	900-450/577/1-1-1	9.216	NA	Director/D	
B.11918	West	FEROZPUR	11KV	DS CITY DIVN. FEROZPUR	DS S/D SHER KHAN	E453FL07	Arman Pura	AMR	OK	31.03.2023		Category 5-UPS				5437696	900-450/577/1-1-1	9.806	NA	Director/D	
B.11919	West	FEROZPUR	11KV	DS CITY DIVN. FEROZPUR	DS S/D SHER KHAN	E453FL03	BHRANA	AMR	OK	31.03.2023		AP 3Phase 3Wire				30332	900-450/577/1-1-1	1.785	NA	Director/D	
B.11920	West	FEROZPUR	11KV	DS CITY DIVN. FEROZPUR	DS S/D SHER KHAN	E453FL01	KADA BOKA	AMR	OK	31.03.2023		AP 3Phase 3Wire				7336665	900-450/577/1-1-1	0.038	NA	Director/D	
B.11921	West	FEROZPUR	11KV	DS CITY DIVN. FEROZPUR	DS S/D SHER KHAN	E453FL12	Mochal	AMR	OK	31.03.2023		AP 3Phase 3Wire				44886	1200/577/1-1-1	1.324	NA	Director/D	
B.11922	West	FEROZPUR	11KV	DS CITY DIVN. FEROZPUR	DS S/D SHER KHAN	E453FL04	BATTA KHERA	AMR	OK	31.03.2023		AP 3Phase 3Wire				7336588	900-450/577/1-1-1	1.376	NA	Director/D	
B.11923	West	FEROZPUR	11KV	DS CITY DIVN. FEROZPUR	DS S/D SHER KHAN	E453FL02	FARIDE WALA	AMR	OK	31.03.2023		AP 3Phase 3Wire				3367	900-450/577/1-1-1	2.190	NA	Director/D	
B.11924	West	FEROZPUR	11KV	DS CITY DIVN. FEROZPUR	DS S/D SHER KHAN	E453FL13	Basti Dhalie Ke	AMR	OK	31.03.2023		AP 3Phase 3Wire				44943	1200/577/1-1-1	2.620	NA	Director/D	
B.11925	West	FEROZPUR	11KV	DS CITY DIVN. FEROZPUR	DS S/D SHER KHAN	E453FL05	RUKAN SHAH WALA	AMR	OK	31.03.2023		AP 3Phase 3Wire				7336579	900-450/577/1-1-1	2.731	NA	Director/D	
B.11926	West	FEROZPUR	11KV	DS CITY DIVN. FEROZPUR	DS S/D SHER KHAN	E453FL11	Bagee Singh Wala	AMR	OK	31.03.2023		AP 3Phase 3Wire				44942	1200/577/1-1-1	2.955	NA	Director/D	
B.11927	West	FEROZPUR	11KV	DS CITY DIVN. FEROZPUR	DS S/D SHER KHAN	E453FL14	SUR SINGH UPS	NON AMR	OK	31.03.2023		Category 5-UPS				4670	1200/577/1-1-1	6.122	NA	Director/D	
B.11928	West	FEROZPUR	11KV	DS CITY DIVN. FEROZPUR	DS S/D SHER KHAN	E453FL03	LOHGARH	AMR	OK	31.03.2023		Category 5-UPS				7336591	900-450/577/1-1-1	9.530	NA	Director/D	
B.11929	West	FEROZPUR	11KV	DS CITY DIVN. FEROZPUR	DS S/D SHER KHAN	B485FL05	BRAR AGRO	AMR	OK	31.03.2023		Category 5-UPS				2840	1200-600/5	1.191	NA	Director/D	
B.11930	West	FEROZPUR	11KV	DS DIVN. JALALABAD	DS CITY S/D GURU HAR SAHAJ	E046FL03	Dona Matter	NON AMR	OK	31.03.2023		AP 3Phase 3Wire				2066425	900-450/577/1-1-1	1.066	NA	Director/D	
B.11931	West	FEROZPUR	11KV	DS DIVN. JALALABAD	DS CITY S/D GURU HAR SAHAJ	E046FL18	SATLU	AMR	OK	31.03.2023		AP 3Phase 3Wire				5988	900-450/577/1-1-1	1.807	NA	Director/D	
B.11932	West	FEROZPUR	11KV	DS DIVN. JALALABAD	DS CITY S/D GURU HAR SAHAJ	E046FL13	Dona Matter - II	AMR	OK	31.03.2023		AP 3Phase 3Wire				9334511	900-450/577/1-1-1	1.621	NA	Director/D	
B.11933	West	FEROZPUR	11KV	DS DIVN. JALALABAD	DS CITY S/D GURU HAR SAHAJ	E046FL06	Triha	AMR	OK	31.03.2023		AP 3Phase 3Wire				8223699	900-450/577/1-1-1	2.585	NA	Director/D	
B.11934	West	FEROZPUR	11KV	DS DIVN. JALALABAD	DS CITY S/D GURU HAR SAHAJ	E046FL01	meghar rai	NON AMR	OK	31.03.2023		Category 5-UPS				9544717	900-450/577/1-1-1	10.883	NA	Director/D	
B.11935	West	FEROZPUR	11KV	DS DIVN. JALALABAD	DS CITY S/D GURU HAR SAHAJ	E046FL14	11 KV Madi Ke UPS	AMR	OK	31.03.2023		Category 5-UPS				3517	900-450/577/1-1-1	10.897	NA	Director/D	
B.11936	West	FEROZPUR	11KV	DS DIVN. JALALABAD	DS CITY S/D GURU HAR SAHAJ	E046FL14	Kandhe Shah	AMR	OK	31.03.2023		AP 3Phase 3Wire				2047148	1200-600/5	1.107	NA	Director/D	
B.11937	West	FEROZPUR	11KV	DS DIVN. JALALABAD	DS CITY S/D GURU HAR SAHAJ	E046FL08	Handa Wala	NON AMR	OK	31.03.2023		AP 3Phase 3Wire				323446	900-450/577/1-1-1	1.218	NA	Director/D	
B.11938	West	FEROZPUR	11KV	DS DIVN. JALALABAD	DS CITY S/D GURU HAR SAHAJ	E046FL13	Punjab Agro	AMR	OK	31.03.2023		Category 4				6740866	1200-600/5	1.762	NA	Director/D	
B.11939	West	FEROZPUR	11KV	DS DIVN. JALALABAD	DS CITY S/D GURU HAR SAHAJ	E046FL18	Chughra-2 AP	AMR	OK	31.03.2023		AP 3Phase 3Wire				15194736	900-450/577/1-1-1	1.784	NA	Director/D	
B.11940	West	FEROZPUR	11KV	DS DIVN. JALALABAD	DS CITY S/D GURU HAR SAHAJ	E046FL01	Awan	NON AMR	OK	31.03.2023		AP 3Phase 3Wire				777823	1200-600/5	2.115	NA	Director/D	
B.11941	West	FEROZPUR	11KV	DS DIVN. JALALABAD	DS CITY S/D GURU HAR SAHAJ	E046FL21	Sukbir Agro Energy Limited	AMR	OK	31.03.2023		Category 4				5546	1200-600/5	2.299	NA	Director/D	
B.11942	West	FEROZPUR	11KV	DS DIVN. JALALABAD	DS CITY S/D GURU HAR SAHAJ	E046FL03	Chaga Rikki	AMR	OK	31.03.2023		AP 3Phase 3Wire				867230	1200-600/5	2.326	NA	Director/D	
B.11943	West	FEROZPUR	11KV	DS DIVN. JALALABAD	DS CITY S/D GURU HAR SAHAJ	E046FL07	Chughra	NON AMR	OK	31.03.2023		AP 3Phase 3Wire				777808	900-450/577/1-1-1	2.982	NA	Director/D	
B.11944	West	FEROZPUR	11KV	DS DIVN. JALALABAD	DS CITY S/D GURU HAR SAHAJ	E046FL04	Town - 3	NON AMR	OK	31.03.2023		Category 2				7042820	1200-600/5	4.554	NA	Director/D	
B.11945	West	FEROZPUR	11KV	DS DIVN. JALALABAD	DS CITY S/D GURU HAR SAHAJ	E046FL06	Town - 1	AMR	OK	31.03.2023		Category 1				7039580	1200-600/5	5.524	NA	Director/D	
B.11946	West	FEROZPUR	11KV	DS DIVN. JALALABAD	DS CITY S/D GURU HAR SAHAJ	E046FL11	NIDHANA	NON AMR	OK	31.03.2023		Category 5-UPS				2065835	1200-600/5	5.909	NA	Director/D	
B.11947	West	FEROZPUR	11KV	DS DIVN. JALALABAD	DS CITY S/D GURU HAR SAHAJ	E046FL19	Shri Pothimala Sahib	NON AMR	OK	31.03.2023		Category 1				35448	1200-600/5	7.205	NA	Director/D	
B.11948	West	FEROZPUR	11KV	DS DIVN. JALALABAD	DS CITY S/D GURU HAR SAHAJ	E046FL17	Handa Wala	NON AMR	OK	31.03.2023		Category 1				323446	900-450/577/1-1-1	7.552	NA	Director/D	
B.11949	West	FEROZPUR	11KV	DS DIVN. JALALABAD	DS CITY S/D GURU HAR SAHAJ	E046FL20	11 KV Railway Basti	NON AMR	OK	31.03.2023		Category 1				3174	1200-600/5	8.437	NA	Director/D	
B.11950	West	FEROZPUR	11KV	DS DIVN. JALALABAD	DS CITY S/D GURU HAR SAHAJ	E046FL05	Town - 2	AMR	OK	31.03.2023		Category 1				7030192	1200-600/5	8.636	NA	Director/D	
B.11951	West	FEROZPUR	11KV	DS DIVN. JALALABAD	DS CITY S/D GURU HAR SAHAJ	E046FL12	Lalchian	NON AMR	OK	31.03.2023		Category 5-UPS				102067487	900-450/577/1-1-1	8.846	NA	Director/D	
B.11952	West	FEROZPUR	11KV	DS DIVN. JALALABAD	DS CITY S/D GURU HAR SAHAJ	E046FL16	Kesar Singh	AMR	OK	31.03.2023		Category 5-UPS				5343288	1200-600/5	11.552	NA	Director/D	
B.11953	West	FEROZPUR	11KV	DS DIVN. JALALABAD	DS CITY S/D GURU HAR SAHAJ	E046FL04	Jana Wala	AMR	OK	31.03.2023		AP 3Phase 3Wire				6669390	900-450/577/1-1-1	1.665	NA	Director/D	
B.11954	West	FEROZPUR	11KV	DS DIVN. JALALABAD	DS CITY S/D GURU HAR SAHAJ	E046FL11	Khana Dhandi	AMR	OK	31.03.2023		AP 3Phase 3Wire				4196511	1200/577/1-1-1	1.042	NA	Director/D	
B.11955	West	FEROZPUR	11KV	DS DIVN. JALALABAD	DS CITY S/D GURU HAR SAHAJ	E047RF10	NVA PIND TARIDA	AMR	OK	31.03.2023		Category 1				4296	1200/577/1-1-1	1.145	NA	Director/D	
B.11956	West	FEROZPUR	11KV	DS DIVN. JALALABAD	DS CITY S/D GURU HAR SAHAJ	E047RF03	Kohar Singh Wala	AMR	OK	31.03.2023		AP 3Phase 3Wire				15193753	1200/577/1-1-1	1.363	NA	Director/D	
B.11957	West	FEROZPUR	11KV	DS DIVN. JALALABAD	DS CITY S/D GURU HAR SAHAJ	E047RF09	LALCHYA	NON AMR	OK	31.03.2023		AP 3Phase 3Wire				3914	1200/577/1-1-1	1.506	NA	Director/D	
B.11958	West	FEROZPUR	11KV	DS DIVN. JALALABAD	DS CITY S/D GURU HAR SAHAJ	E047RF05	Budhe Shah	NON AMR	OK	31.03.2023		AP 3Phase 3Wire				13190466	1200/577/1-1-1	1.646	NA	Director/D	
B.11959	West	FEROZPUR	11KV	DS DIVN. JALALABAD	DS CITY S/D GURU HAR SAHAJ	E047RF06	Handa Wala	NON AMR	OK	31.03.2023		Category 5-UPS				23488	1200/577/1-1-1	7.034	NA	Director/D	
B.11960	West	FEROZPUR	11KV	DS DIVN. JALALABAD	DS CITY S/D GURU HAR SAHAJ	E047FL02	11 KV Kahana Singh AP	AMR	OK	31.03.2023		AP 3Phase 3Wire				15193876	900-450/577/1-1-1	1.089	NA	Director/D	
B.11961	West	FEROZPUR	11KV	DS DIVN. JALALABAD	DS CITY S/D GURU HAR SAHAJ	E072FL01	11 KV LAPPo AP	AMR	OK	31.03.2023		AP 3Phase 3Wire				15193724	900-450/577/1-1-1	1.3			

S.No	Zone	Circle	Voltage Level (kVA)	Division (kVA)	Sub-Division (kVA)	Feeder ID	Feeder Name	Feeder Metering Status (Metered/unmetered/AMR/AMI)	Status of Meter (Functional/Non-Functional)	Metering Date	Date of last actual meter reading/communication	Feeder Type (Agr/Industrial/Mixed)	Status of Communication			Period from 01.04.2021 to 31.03.2022				Sales	Remarks (Source of data)
													% data received through automatically if feeder AMR/AMI	Number of hours when meter was unable to communicate in overall	Total Number of hours in the period	Meter S.No	CT/PT ratio	Import (kWh)	Export (kWh)		
B.11998	West	FEROZPUR	11KV	DS DIVN. JALALABAD	DS CITY S/D JALALABAD	D468F06	11KV UPS MAHALAM	AMR	OK	31.03.2023		Category 5-UPS				2046481	900-450/577/1-1-1	9.629	NA	Director/D	
B.11999	West	FEROZPUR	11KV	DS DIVN. JALALABAD	DS CITY S/D JALALABAD	D549T13	Chak Suhele Wala AP	AMR	OK	31.03.2023		AP 3Phase 3Wire	198056	900-450/577/1-1-1	0.923	23	NA	Director/D			
B.12000	West	FEROZPUR	11KV	DS DIVN. JALALABAD	DS CITY S/D JALALABAD	D549T14	Chak Suhele Wala UPS	NON AMR	OK	31.03.2023		AP 3Phase 1	197898	900-450/577/1-1-1	2.556	NA	Director/D				
B.12001	West	FEROZPUR	11KV	DS DIVN. JALALABAD	DS CITY S/D JALALABAD	D481F03	Jhian Pawla kale Wala	NON AMR	OK	31.03.2023		Category 1	245302	900-450/577/1-1-1	1.013	NA	Director/D				
B.12002	West	FEROZPUR	11KV	DS DIVN. JALALABAD	DS CITY S/D JALALABAD	D481F05	11KV Chak Saido Ke-1	NON AMR	OK	31.03.2023		AP 3Phase 3Wire	24298	900-450/577/1-1-1	1.467	NA	Director/D				
B.12003	West	FEROZPUR	11KV	DS DIVN. JALALABAD	DS CITY S/D JALALABAD	D481F02	Suhele Wala	NON AMR	OK	31.03.2023		AP 3Phase 3Wire	24300	900-450/577/1-1-1	1.468	NA	Director/D				
B.12004	West	FEROZPUR	11KV	DS DIVN. JALALABAD	DS CITY S/D JALALABAD	D481F01	Dhab Khushal Jovla	NON AMR	OK	31.03.2023		AP 3Phase 3Wire	24299	900-450/577/1-1-1	1.746	NA	Director/D				
B.12005	West	FEROZPUR	11KV	DS DIVN. JALALABAD	DS CITY S/D JALALABAD	D481F06	Tahla Sahib	NON AMR	OK	31.03.2023		AP 3Phase 3Wire	37139	900-450/577/1-1-1	2.104	NA	Director/D				
B.12006	West	FEROZPUR	11KV	DS DIVN. JALALABAD	DS CITY S/D JALALABAD	D481F07	Chang Khurud UPS	NON AMR	OK	31.03.2023		Category 5-UPS	37040	900-450/577/1-1-1	3.265	NA	Director/D				
B.12007	West	FEROZPUR	11KV	DS DIVN. JALALABAD	DS CITY S/D JALALABAD	D481F04	Wan Mohkam Wali UPS	NON AMR	OK	31.03.2023		Category 5-UPS	24103	900-450/577/1-1-1	5.388	NA	Director/D				
B.12008	West	FEROZPUR	11KV	DS DIVN. JALALABAD	DS CITY S/D JALALABAD	D07T1F05	Peer Baksh Chouhan Road	Not available	OK	31.03.2023		Category 2	198037	900-450/577/1-1-1	11.602	NA	Director/D				
B.12009	West	FEROZPUR	66KV	DS DIVN. JALALABAD	DS CITY S/D JALALABAD	D481C2	Grosipin Fabz	AMR	OK	31.03.2023		Category 4	Not available	Not available	19.366	NA	Director/D				
B.12010	West	FEROZPUR	11KV	DS DIVN. JALALABAD	DS S/D GHOBAYA	C453FL05	Sukhera Boda	AMR	OK	31.03.2023		AP 3Phase 3Wire	9568261	900-450/577/1-1-1	2.100	NA	Director/D				
B.12011	West	FEROZPUR	11KV	DS DIVN. JALALABAD	DS S/D GHOBAYA	C453FL21	Bara Wala AP	AMR	OK	31.03.2023		AP 3Phase 3Wire	9568306	400-200/5-5	2.424	NA	Director/D				
B.12012	West	FEROZPUR	11KV	DS DIVN. JALALABAD	DS S/D GHOBAYA	C453FL05	Mohar Singh Wala	NON AMR	OK	31.03.2023		AP 3Phase 3Wire	9568294	400-200/5-5	2.544	NA	Director/D				
B.12013	West	FEROZPUR	11KV	DS DIVN. JALALABAD	DS S/D GHOBAYA	245FL14	Kalu wala	AMR	OK	31.03.2023		Category 5-UPS	23752	900-450/577/1-1-1	7.572	NA	Director/D				
B.12014	West	FEROZPUR	11KV	DS DIVN. JALALABAD	DS S/D GHOBAYA	8453FL04	TAHALI WALA	NON AMR	OK	31.03.2023		AP 3Phase 3Wire	2046505	1200-600/5-5	0.879	NA	Director/D				
B.12015	West	FEROZPUR	11KV	DS DIVN. JALALABAD	DS S/D GHOBAYA	8453FL13	Bhavra AP	NON AMR	OK	31.03.2023		AP 3Phase 3Wire	6454	1200-600/5-5	1.410	NA	Director/D				
B.12016	West	FEROZPUR	11KV	DS DIVN. JALALABAD	DS S/D GHOBAYA	8453FL15	Mojie Wala AP	AMR	OK	31.03.2023		AP 3Phase 3Wire	5150	1200-600/5-5	1.503	NA	Director/D				
B.12017	West	FEROZPUR	11KV	DS DIVN. JALALABAD	DS S/D GHOBAYA	8453FL09	MANJRI SINGH WALA	AMR	OK	31.03.2023		AP 3Phase 3Wire	60761983	1200-600/5-5	1.538	NA	Director/D				
B.12018	West	FEROZPUR	11KV	DS DIVN. JALALABAD	DS S/D GHOBAYA	8453FL05	Machhwalla	AMR	OK	31.03.2023		AP 3Phase 3Wire	8232720	1200-600/5-5	1.578	NA	Director/D				
B.12019	West	FEROZPUR	11KV	DS DIVN. JALALABAD	DS S/D GHOBAYA	8453FL08	MURAK WALA	NON AMR	OK	31.03.2023		AP 3Phase 3Wire	2066648	1200-600/5-5	1.662	NA	Director/D				
B.12020	West	FEROZPUR	11KV	DS DIVN. JALALABAD	DS S/D GHOBAYA	8453FL16	Balaki Wala AP	AMR	OK	31.03.2023		AP 3Phase 3Wire	5458	1200-600/5-5	1.678	NA	Director/D				
B.12021	West	FEROZPUR	11KV	DS DIVN. JALALABAD	DS S/D GHOBAYA	8453FL02	KHUND WALA	NON AMR	OK	31.03.2023		AP 3Phase 3Wire	2068422	1200-600/5-5	1.980	NA	Director/D				
B.12022	West	FEROZPUR	11KV	DS DIVN. JALALABAD	DS S/D GHOBAYA	8453FL18	Bhamba Wattu AP	NON AMR	OK	31.03.2023		AP 3Phase 3Wire	6178	1200-600/5-5	2.008	NA	Director/D				
B.12023	West	FEROZPUR	11KV	DS DIVN. JALALABAD	DS S/D GHOBAYA	8453FL14	Ghele Wala AP	AMR	OK	31.03.2023		AP 3Phase 3Wire	6125	1200-600/5-5	2.081	NA	Director/D				
B.12024	West	FEROZPUR	11KV	DS DIVN. JALALABAD	DS S/D GHOBAYA	8453FL03	FATU WALA	AMR	OK	31.03.2023		AP 3Phase 3Wire	2066983	1200-600/5-5	2.289	NA	Director/D				
B.12025	West	FEROZPUR	11KV	DS DIVN. JALALABAD	DS S/D GHOBAYA	8453FL10	CHAK WAZIDA	NON AMR	OK	31.03.2023		AP 3Phase 3Wire	7042884	1200-600/5-5	2.332	NA	Director/D				
B.12026	West	FEROZPUR	11KV	DS DIVN. JALALABAD	DS S/D GHOBAYA	8453FL17	Chak Khiva AP	AMR	OK	31.03.2023		AP 3Phase 3Wire	5357	1200-600/5-5	2.639	NA	Director/D				
B.12027	West	FEROZPUR	11KV	DS DIVN. JALALABAD	DS S/D GHOBAYA	8453FL06	KISSAN FACTS	NON AMR	OK	31.03.2023		Category 4	58654	1200-600/5-5	2.823	NA	Director/D				
B.12028	West	FEROZPUR	11KV	DS DIVN. JALALABAD	DS S/D GHOBAYA	8453FL01	GURUBAYA	AMR	OK	31.03.2023		Category 1	2065499	1200-600/5-5	5.783	NA	Director/D				
B.12029	West	FEROZPUR	11KV	DS DIVN. JALALABAD	DS S/D GHOBAYA	8453FL12	SUNDE PURA	AMR	OK	31.03.2023		Category 5-UPS	7336839	1200-600/5-5	6.795	NA	Director/D				
B.12030	West	FEROZPUR	11KV	DS DIVN. JALALABAD	DS S/D GHOBAYA	8453FL11	MOHAMMED WALA	AMR	OK	31.03.2023		Category 5-UPS	4189882	1200-600/5-5	8.410	NA	Director/D				
B.12031	West	FEROZPUR	11KV	DS DIVN. JALALABAD	DS S/D GHOBAYA	8453FL07	LAMOCHAR KALAN UPS	NON AMR	OK	31.03.2023		Category 5-UPS	6740773	1200-600/5-5	11.361	NA	Director/D				
B.12032	West	FEROZPUR	11KV	DS DIVN. JALALABAD	DS S/D GHOBAYA	D01FL01	Gariba Sander	AMR	OK	31.03.2023		Category 5-UPS	1432	1200/577/1-1-1	5.665	NA	Director/D				
B.12033	West	FEROZPUR	11KV	DS DIVN. JALALABAD	DS S/D GHOBAYA	D01FL08	BASTI KERA UPS	AMR	OK	31.03.2023		Category 5-UPS	5335	1200/577/1-1-1	7.497	NA	Director/D				
B.12034	West	FEROZPUR	11KV	DS DIVN. JALALABAD	DS S/D GHOBAYA	D508F08	Boop	AMR	OK	31.03.2023		Category 1	2067566	1200-600/5-5	0.945	NA	Director/D				
B.12035	West	FEROZPUR	11KV	DS DIVN. JALALABAD	DS S/D GHOBAYA	D508F07	BHAMBIA WATTU	AMR	OK	31.03.2023		AP 3Phase 1	761910	900-450/577/1-1-1	2.398	NA	Director/D				
B.12036	West	FEROZPUR	11KV	DS DIVN. JALALABAD	DS S/D GHOBAYA	D508F02	CHAK KHIVA	NON AMR	OK	31.03.2023		AP 3Phase 3Wire	13190558	1200-600/5-5	2.535	NA	Director/D				
B.12037	West	FEROZPUR	11KV	DS DIVN. JALALABAD	DS S/U S/D GURU HAR SAHAI	D464FL19	Changa Rai	NON AMR	OK	31.03.2023		AP 3Phase 3Wire	4748	900-450/577/1-1-1	1.139	NA	Director/D				
B.12038	West	FEROZPUR	11KV	DS DIVN. JALALABAD	DS S/U S/D GURU HAR SAHAI	D464FL12	Changa Rai	NON AMR	OK	31.03.2023		AP 3Phase 3Wire	10823697	900-450/577/1-1-1	1.330	NA	Director/D				
B.12039	West	FEROZPUR	11KV	DS DIVN. JALALABAD	DS S/U S/D GURU HAR SAHAI	D464FL15	CHAK SHIKARGARH	NON AMR	OK	31.03.2023		AP 3Phase 3Wire	4683	900-450/577/1-1-1	1.433	NA	Director/D				
B.12040	West	FEROZPUR	11KV	DS DIVN. JALALABAD	DS S/U S/D GURU HAR SAHAI	D464FL17	Bak Ke-2	AMR	OK	31.03.2023		AP 3Phase 3Wire	4758	900-450/577/1-1-1	1.530	NA	Director/D				
B.12041	West	FEROZPUR	11KV	DS DIVN. JALALABAD	DS S/U S/D GURU HAR SAHAI	D464FL07	Bahader Ke-1	AMR	OK	31.03.2023		AP 3Phase 3Wire	10281389	900-450/577/1-1-1	1.545	NA	Director/D				
B.12042	West	FEROZPUR	11KV	DS DIVN. JALALABAD	DS S/U S/D GURU HAR SAHAI	D464FL09	BAHADER KE-2	NON AMR	OK	31.03.2023		AP 3Phase 3Wire	9544712	900-450/577/1-1-1	1.566	NA	Director/D				
B.12043	West	FEROZPUR	11KV	DS DIVN. JALALABAD	DS S/U S/D GURU HAR SAHAI	D464FL05	UPS Bajle Ke	AMR	OK	31.03.2023		Category 5-UPS	910108	900-450/577/1-1-1	1.566	NA	Director/D				
B.12044	West	FEROZPUR	11KV	DS DIVN. JALALABAD	DS S/U S/D GURU HAR SAHAI	D464FL10	PALLE CHAK	AMR	OK	31.03.2023		AP 3Phase 3Wire	2267784	900-450/577/1-1-1	1.608	NA	Director/D				
B.12045	West	FEROZPUR	11KV	DS DIVN. JALALABAD	DS S/U S/D GURU HAR SAHAI	D464FL02	Boop Khopra-3	AMR	OK	31.03.2023		AP 3Phase 3Wire	8232300	900-450/577/1-1-1	1.816	NA	Director/D				
B.12046	West	FEROZPUR	11KV	DS DIVN. JALALABAD	DS S/U S/D GURU HAR SAHAI	D464FL11	Zhimbian wala	AMR	OK	31.03.2023		AP 3Phase 3Wire	2267784	900-450/577/1-1-1	1.883	NA	Director/D				
B.12047	West	FEROZPUR	11KV	DS DIVN. JALALABAD	DS S/U S/D GURU HAR SAHAI	D464FL04	Bajle Ke	NON AMR	OK	31.03.2023		AP 3Phase 3Wire	7336542	900-450/577/1-1-1	1.909	NA	Director/D				
B.12048	West	FEROZPUR	11KV	DS DIVN. JALALABAD	DS S/U S/D GURU HAR SAHAI	D464FL08	GOLUKE	NON AMR	OK	31.03.2023		Category 5-UPS	10281232	900-450/577/1-1-1	8.913	NA	Director/D				
B.12049	West	FEROZPUR	11KV	DS DIVN. JALALABAD	DS S/U S/D GURU HAR SAHAI	D464FL10	Nidhana	AMR	OK	31.03.2023		AP 3Phase 3Wire	10635	1200-600/5-5	1.261	NA	Director/D				
B.12050	West	FEROZPUR	11KV	DS DIVN. JALALABAD	DS S/U S/D GURU HAR SAHAI	D464FL09	Gollu Ke	AMR	OK	31.03.2023		AP 3Phase 3Wire	8226270	1200-600/5-5	1.622	NA	Director/D				
B.12051	West	FEROZPUR	11KV	DS DIVN. JALALABAD	DS S/U S/D GURU HAR SAHAI	D464FL02	Mohan Ke	AMR	OK	31.03.2023		AP 3Phase 3Wire	5648	900-450/577/1-1-1	1.849	NA	Director/D				
B.12052	West	FEROZPUR	11KV	DS DIVN. JALALABAD	DS S/U S/D GURU HAR SAHAI	D464FL12	Khutti	AMR	OK	31.03.2023		AP 3Phase 3Wire	5648	900-450/577/1-1-1	0.987	NA	Director/D				
B.12053	West	FEROZPUR	11KV	DS DIVN. JALALABAD	DS S/U S/D GURU HAR SAHAI	D464FL07	Jhari Wala URBAN	NON AMR	OK	31.03.2023		Category 5-UPS	9154451	900-450/577/1-1-1	1.070	NA	Director/D				
B.12054	West	FEROZPUR	11KV	DS DIVN. JALALABAD	DS S/U S/D GURU HAR SAHAI	D464FL18	Jharwala	AMR	OK	31.03.2023		AP 3Phase 3Wire	4019	900-450/577/1-1-1	1.207	NA	Director/D				
B.12055	West	FEROZPUR	11KV	DS DIVN. JALALABAD	DS S/U S/D GURU HAR SAHAI	D464FL11	CHAK MAHANTA WALA	AMR	OK	31.03.2023		AP 3Phase 3Wire	4063	900-450/577/1-1-1	1.363	NA	Director/D				
B.12056	West	FEROZPUR	11KV	DS DIVN. JALALABAD	DS S/U S/D GURU HAR SAHAI	D464FL01	Taba														

S.No	Zone	Circle	Voltage Level (kVA)	Division (kVA)	Sub-Division (kVA)	Feeder ID	Feeder Name	Feeder Metering Status (Metered/unmetered/AMR/AMI)	Status of Meter (Functional/Non-Functional)	Metering Date (Date of last actual meter reading/communication)	Feeder Type (Agr/Industrial/Mixed)	Status of Communication			Period from 01.04.2021 to 31.03.2022				Sales	Remarks (Source of data)
												% data received through automatically if feeder AMR/AMI	Number of hours when meter was unable to communicate in overall	Total Number of hours in the period	Meter S.No	CT/PT ratio	Import (kU)	Export (kU)		
B.12095	West	FEROZPUR	11KV	D5 DIVN. JALALABAD	D5 S/U S/D JALALABAD	D470FL10	NATHA SINGH WALA	AMR	OK	31.03.2023	AP 3Phase 3Wire				10281180	900-450/577/1-1-1	2.272	NA	Director/D	
B.12096	West	FEROZPUR	11KV	D5 DIVN. JALALABAD	D5 S/U S/D JALALABAD	D470FL03	Peere Ke	AMR	OK	31.03.2023	AP 3Phase 3Wire				9568308	900-450/577/1-1-1	2.305	NA	Director/D	
B.12097	West	FEROZPUR	11KV	D5 DIVN. JALALABAD	D5 S/U S/D JALALABAD	D470FL09	Ufian Dhandi Qudim	AMR	OK	31.03.2023	Category 1				5295993	900-450/577/1-1-1	2.358	NA	Director/D	
B.12098	West	FEROZPUR	11KV	D5 DIVN. JALALABAD	D5 S/U S/D JALALABAD	D470FL07	Kishan	AMR	OK	31.03.2023	AP 3Phase 3Wire				9154020	900-450/577/1-1-1	2.458	NA	Director/D	
B.12099	West	FEROZPUR	11KV	D5 DIVN. JALALABAD	D5 S/U S/D JALALABAD	D470FL02	Dhandi Qudim	NON AMR	OK	31.03.2023	AP 3Phase 3Wire				2045480	900-450/577/1-1-1	2.546	NA	Director/D	
B.12100	West	FEROZPUR	11KV	D5 DIVN. JALALABAD	D5 S/U S/D JALALABAD	D470FL12	11 Fulla Singh AP	AMR	OK	31.03.2023	AP 3Phase 3Wire				198012	900-450/577/1-1-1	2.614	NA	Director/D	
B.12101	West	FEROZPUR	11KV	D5 DIVN. JALALABAD	D5 S/U S/D JALALABAD	D470FL04	GATTI BISO	AMR	OK	31.03.2023	AP 3Phase 3Wire				2067979	900-450/577/1-1-1	2.807	NA	Director/D	
B.12102	West	FEROZPUR	11KV	D5 DIVN. JALALABAD	D5 S/U S/D JALALABAD	D470FL08	3pn UPS (Peere Ke)	AMR	OK	31.03.2023	Category 5-UPS				2044480	900-450/577/1-1-1	6.328	NA	Director/D	
B.12103	West	FEROZPUR	11KV	D5 DIVN. JALALABAD	D5 S/U S/D JALALABAD	D470FL11	3 P 3 Wire Santokh Singh Wala	AMR	OK	31.03.2023	Category 5-UPS				9154030	900-450/577/1-1-1	9.446	NA	Director/D	
B.12104	West	FEROZPUR	11KV	D5 DIVN. JALALABAD	D5 S/U S/D JALALABAD	D466FL06	SWAH Wala	NON AMR	OK	31.03.2023	AP 3Phase 3Wire				2067240	900-450/577/1-1-1	1.767	NA	Director/D	
B.12105	West	FEROZPUR	11KV	D5 DIVN. JALALABAD	D5 S/U S/D JALALABAD	D466FL09	Telian Wala	NON AMR	OK	31.03.2023	AP 3Phase 3Wire				2646	900-450/577/1-1-1	1.972	NA	Director/D	
B.12106	West	FEROZPUR	11KV	D5 DIVN. JALALABAD	D5 S/U S/D JALALABAD	D467FL09	Urban Noore ke	NON AMR	OK	31.03.2023	Category 1				23624	900-450/577/1-1-1	0.556	NA	Director/D	
B.12107	West	FEROZPUR	11KV	D5 DIVN. JALALABAD	D5 S/U S/D JALALABAD	D469FL15	Sher Mahomad	AMR	OK	31.03.2023	AP 3Phase 3Wire				4772	900-450/577/1-1-1	1.205	NA	Director/D	
B.12108	West	FEROZPUR	11KV	D5 DIVN. JALALABAD	D5 S/U S/D JALALABAD	D469FL07	Ganau Wala	AMR	OK	31.03.2023	AP 3Phase 3Wire				2994150	900-450/577/1-1-1	1.595	NA	Director/D	
B.12109	West	FEROZPUR	11KV	D5 DIVN. JALALABAD	D5 S/U S/D JALALABAD	D469FL06	Gatti Nabh Singh Wala	NON AMR	OK	31.03.2023	AP 3Phase 3Wire				9154090	900-450/577/1-1-1	1.601	NA	Director/D	
B.12110	West	FEROZPUR	11KV	D5 DIVN. JALALABAD	D5 S/U S/D JALALABAD	D469FL13	Kasim Ke	AMR	OK	31.03.2023	AP 3Phase 3Wire				4726	900-450/577/1-1-1	1.661	NA	Director/D	
B.12111	West	FEROZPUR	11KV	D5 DIVN. JALALABAD	D5 S/U S/D JALALABAD	D469FL02	Bhuran Bhatti	NON AMR	OK	31.03.2023	AP 3Phase 3Wire				9534427	900-450/577/1-1-1	1.709	NA	Director/D	
B.12112	West	FEROZPUR	11KV	D5 DIVN. JALALABAD	D5 S/U S/D JALALABAD	D469FL14	MOHNE WALA	AMR	OK	31.03.2023	AP 3Phase 3Wire				4720	900-450/577/1-1-1	1.811	NA	Director/D	
B.12113	West	FEROZPUR	11KV	D5 DIVN. JALALABAD	D5 S/U S/D JALALABAD	D469FL04	Ghulla	AMR	OK	31.03.2023	AP 3Phase 3Wire				9534406	900-450/577/1-1-1	1.873	NA	Director/D	
B.12114	West	FEROZPUR	11KV	D5 DIVN. JALALABAD	D5 S/U S/D JALALABAD	D469FL03	DULLER KE	AMR	OK	31.03.2023	AP 3Phase 3Wire				9568303	900-450/577/1-1-1	2.203	NA	Director/D	
B.12115	West	FEROZPUR	11KV	D5 DIVN. JALALABAD	D5 S/U S/D JALALABAD	D469FL05	3PN UPS Noore Ke	NON AMR	OK	31.03.2023	Category 5-UPS				2993117	900-450/577/1-1-1	8.606	NA	Director/D	
B.12116	West	FEROZPUR	11KV	D5 DIVN. JALALABAD	D5 S/U S/D JALALABAD	D031FL03	Dhani Amar Singh	NON AMR	OK	31.03.2023	AP 3Phase 3Wire				1475	1200/577/1-1-1	0.960	NA	Director/D	
B.12117	West	FEROZPUR	11KV	D5 DIVN. JALALABAD	D5 S/U S/D JALALABAD	D031FL05	Guru Nanak Nagar	NON AMR	OK	31.03.2023	AP 3Phase 3Wire				198008	1200/577/1-1-1	0.976	NA	Director/D	
B.12118	West	FEROZPUR	11KV	D5 DIVN. JALALABAD	D5 S/U S/D JALALABAD	D031FL06	GATTI HASAL	AMR	OK	31.03.2023	AP 3Phase 3Wire				14929	1200/577/1-1-1	1.501	NA	Director/D	
B.12119	West	FEROZPUR	11KV	D5 DIVN. JALALABAD	D5 S/U S/D JALALABAD	D031FL04	Dhani Maan Singh	NON AMR	OK	31.03.2023	AP 3Phase 3Wire				197922	1200/577/1-1-1	1.895	NA	Director/D	
B.12120	West	FEROZPUR	11KV	D5 DIVN. JALALABAD	D5 S/U S/D JALALABAD	D031FL02	Jodha Bhanu UPS	NON AMR	OK	31.03.2023	Category 5-UPS				198070	1200/577/1-1-1	2.006	NA	Director/D	
B.12121	West	FEROZPUR	11KV	D5 DIVN. JALALABAD	D5 S/U S/D JALALABAD	D481FL08	SUNDERPURA	NON AMR	OK	31.03.2023	AP 3Phase 3Wire				4554	900-450/577/1-1-1	0.639	NA	Director/D	
B.12122	West	FEROZPUR	11KV	D5 DIVN. JALALABAD	D5 S/U S/D JALALABAD	D71FL04	Peer Bakash Chouhan Urban	AMR	OK	31.03.2023	Category 5-UPS				34003	900-450/577/1-1-1	0.675	NA	Director/D	
B.12123	West	FEROZPUR	11KV	D5 DIVN. JALALABAD	D5 S/U S/D JALALABAD	D71FL02	Nathu Chistian	NON AMR	OK	31.03.2023	AP 3Phase 3Wire				93167	900-450/577/1-1-1	1.222	NA	Director/D	
B.12124	West	FEROZPUR	11KV	D5 DIVN. JALALABAD	D5 S/U S/D JALALABAD	D71FL08	S Bhagesh Singh	AMR	OK	31.03.2023	AP 3Phase 3Wire				4961	900-450/577/1-1-1	1.312	NA	Director/D	
B.12125	West	FEROZPUR	11KV	D5 DIVN. JALALABAD	D5 S/U S/D JALALABAD	D71FL07	Chouhana	NON AMR	OK	31.03.2023	AP 3Phase 3Wire				4438	900-450/577/1-1-1	1.852	NA	Director/D	
B.12126	West	FEROZPUR	11KV	D5 DIVN. JALALABAD	D5 S/U S/D JALALABAD	D71FL03	Thara Singh Wala	NON AMR	OK	31.03.2023	AP 3Phase 3Wire				935165	900-450/577/1-1-1	2.153	NA	Director/D	
B.12127	West	FEROZPUR	11KV	D5 DIVN. JALALABAD	D5 S/U S/D JALALABAD	D71FL03	Thara Singh UPS	AMR	OK	31.03.2023	Category 5-UPS				43159	900-450/577/1-1-1	6.770	NA	Director/D	
B.12128	West	FEROZPUR	11KV	D5 DIVN. JALALABAD	D5 S/U S/D JALALABAD	D71FL06	Amir Khas UPS	AMR	OK	31.03.2023	Category 5-UPS				16194408	900-450/577/1-1-1	10.180	NA	Director/D	
B.12129	West	FEROZPUR	11KV	D5 DIVN. ZIRA	D5 S/D MAKHU	B453FL04	NOORPUR AP	AMR	OK	31.03.2023	AP 3Phase 3Wire				8223643	900-450/577/1-1-1	0.325	NA	Director/D	
B.12130	West	FEROZPUR	11KV	D5 DIVN. ZIRA	D5 S/D MAKHU	D471FL12	UPS III	AMR	OK	31.03.2023	Category 5-UPS				4447	1200-600/5	0.965	NA	Director/D	
B.12131	West	FEROZPUR	11KV	D5 DIVN. ZIRA	D5 S/D MAKHU	D471FL08	BEHAK GUIRA	AMR	OK	31.03.2023	AP 3Phase 3Wire				8223399	1200-600/5	1.345	NA	Director/D	
B.12132	West	FEROZPUR	11KV	D5 DIVN. ZIRA	D5 S/D MAKHU	D471FL03	BUTTER	AMR	OK	31.03.2023	AP 3Phase 3Wire				8223398	1200-600/5	2.238	NA	Director/D	
B.12133	West	FEROZPUR	11KV	D5 DIVN. ZIRA	D5 S/D MAKHU	D471FL11	11KV NOORPUR-N	AMR	OK	31.03.2023	AP 3Phase 3Wire				147369	1200-600/5	2.269	NA	Director/D	
B.12134	West	FEROZPUR	11KV	D5 DIVN. ZIRA	D5 S/D MAKHU	D471FL02	BASTI BUTTE WALI	AMR	OK	31.03.2023	AP 3Phase 3Wire				8223400	1200-600/5	2.461	NA	Director/D	
B.12135	West	FEROZPUR	11KV	D5 DIVN. ZIRA	D5 S/D MAKHU	D471FL07	11KV DHANDIAN AP	AMR	OK	31.03.2023	AP 3Phase 3Wire				12093461	1200-600/5	2.700	NA	Director/D	
B.12136	West	FEROZPUR	11KV	D5 DIVN. ZIRA	D5 S/D MAKHU	D471FL05	CHULLA	AMR	OK	31.03.2023	AP 3Phase 3Wire				6489745	1200-600/5	2.930	NA	Director/D	
B.12137	West	FEROZPUR	11KV	D5 DIVN. ZIRA	D5 S/D MAKHU	D471FL01	MACHAN	AMR	OK	31.03.2023	AP 3Phase 3Wire				8223321	1200-600/5	2.454	NA	Director/D	
B.12138	West	FEROZPUR	11KV	D5 DIVN. ZIRA	D5 S/D MAKHU	D471FL04	MACHAN	NON AMR	OK	31.03.2023	AP 3Phase 3Wire				8223321	1200-600/5	3.902	NA	Director/D	
B.12139	West	FEROZPUR	11KV	D5 DIVN. ZIRA	D5 S/D MAKHU	D471FL06	UPS	NON AMR	OK	31.03.2023	Category 5-UPS				6669379	1200-600/5	8.564	NA	Director/D	
B.12140	West	FEROZPUR	11KV	D5 DIVN. ZIRA	D5 S/D MAKHU	D471FL09	11KV UPS-II BEHAK GUIRAN	NON AMR	OK	31.03.2023	Category 5-UPS				6679863	1200-600/5	10.245	NA	Director/D	
B.12141	West	FEROZPUR	11KV	D5 DIVN. ZIRA	D5 S/D MAKHU	D453FL16	11 KV UPS-I	NON AMR	OK	31.03.2023	Category 5-UPS				7336435	900-450/577/1-1-1	0.000	NA	Director/D	
B.12142	West	FEROZPUR	11KV	D5 DIVN. ZIRA	D5 S/D MAKHU	D453FL05	DASIMESH	AMR	OK	31.03.2023	Category 1				1065958	900-450/577/1-1-1	0.653	NA	Director/D	
B.12143	West	FEROZPUR	11KV	D5 DIVN. ZIRA	D5 S/D MAKHU	D453FL07	SARHAL	AMR	OK	31.03.2023	AP 3Phase 3Wire				10288396	1200-600/5	1.012	NA	Director/D	
B.12144	West	FEROZPUR	11KV	D5 DIVN. ZIRA	D5 S/D MAKHU	D453FL02	CANAL	AMR	OK	31.03.2023	AP 3Phase 3Wire				778131	1200-600/5	1.479	NA	Director/D	
B.12145	West	FEROZPUR	11KV	D5 DIVN. ZIRA	D5 S/D MAKHU	D453FL18	11 KV KHADOOR AP	AMR	OK	31.03.2023	AP 3Phase 3Wire				285687	900-450/577/1-1-1	1.487	NA	Director/D	
B.12146	West	FEROZPUR	11KV	D5 DIVN. ZIRA	D5 S/D MAKHU	D453FL22	11KV SARHALI AP	AMR	OK	31.03.2023	AP 3Phase 3Wire				34444	900-450/577/1-1-1	1.635	NA	Director/D	
B.12147	West	FEROZPUR	11KV	D5 DIVN. ZIRA	D5 S/D MAKHU	D453FL04	RILLI BODLAN	NON AMR	OK	31.03.2023	AP 3Phase 3Wire				8223396	1200-600/5	1.640	NA	Director/D	
B.12148	West	FEROZPUR	11KV	D5 DIVN. ZIRA	D5 S/D MAKHU	D453FL03	11KV RIR MOHAMAD	AMR	OK	31.03.2023	AP 3Phase 3Wire				10288406	1200-600/5	1.681	NA	Director/D	
B.12149	West	FEROZPUR	11KV	D5 DIVN. ZIRA	D5 S/D MAKHU	D453FL14	SHANPARI	AMR	OK	31.03.2023	AP 3Phase 3Wire				8223397	900-450/577/1-1-1	1.773	NA	Director/D	
B.12150	West	FEROZPUR	11KV	D5 DIVN. ZIRA	D5 S/D MAKHU	D453FL21	11KV BEHAK FATTU AP	AMR	OK	31.03.2023	AP 3Phase 3Wire				36186	900-450/577/1-1-1	1.798	NA	Director/D	
B.12151	West	FEROZPUR	11KV	D5 DIVN.																

S.No	Zone	Circle	Voltage Level (kVA)	Division (kVA)	Sub-Division (kVA)	Feeder ID	Feeder Name	Feeder Metering Status (Metered/unmetered/AMR/AM)	Status of Meter (Functional/Non-functional)	Metering Date	% data received through automatically if feeder AMR/AM	Status of Communication		Period from 01.04.2021 to 31.03.2022				Sales	Remarks (Source of data)
												Total Number of hours in the period	Number of hours when meter was unable to communicate in meter	Meter S.No	CT/PT ratio	Import (kWh)	Export (kWh)		
B.12192	West	FEROZPUR	11KV	DS DIVN. ZIRA	DS S/D MAKHU	B454FL04	11KV BAGGI PATNI AP	NON AMR	OK	31.03.2023	AP 3Phase 3Wire	11117094	1200/577/1-1-1	1,706	NA	Director/D			
B.12193	West	FEROZPUR	11KV	DS DIVN. ZIRA	DS S/D MAKHU	B453FL17	11KV PIR MOHAMAD AP	NON AMR	OK	31.03.2023	AP 3Phase 3Wire	11114492	1200/577/1-1-1	1,824	NA	Director/D			
B.12194	West	FEROZPUR	11KV	DS DIVN. ZIRA	DS S/D MAKHU	B454FL06	11KV WALLE WALA	NON AMR	OK	31.03.2023	AP 3Phase 3Wire	11116976	1200/577/1-1-1	2,204	NA	Director/D			
B.12195	West	FEROZPUR	11KV	DS DIVN. ZIRA	DS S/D MAKHU	B454FL05	11KV PIR MOHAMAD	NON AMR	OK	31.03.2023	Category 5 UPS	11116971	1200/577/1-1-1	9,181	NA	Director/D			
B.12196	West	FEROZPUR	11KV	DS DIVN. ZIRA	DS S/D MALLANWALA	B453FL14	AARIF KE 2	NON AMR	OK	31.03.2023	AP 3Phase 3Wire	5619	900-450/577/1-1-1	0,702	NA	Director/D			
B.12197	West	FEROZPUR	11KV	DS DIVN. ZIRA	DS S/D MALLANWALA	B472FL07	11KV KHAROLLE	NON AMR	OK	31.03.2023	AP 3Phase 3Wire	1111	900-450/577/1-1-1	1,561	NA	Director/D			
B.12198	West	FEROZPUR	11KV	DS DIVN. ZIRA	DS S/D MALLANWALA	B453FL09	AARF KE 1 + 2	AMR	OK	31.03.2023	Category 5 UPS	777248	900-450/577/1-1-1	1,847	NA	Director/D			
B.12199	West	FEROZPUR	11KV	DS DIVN. ZIRA	DS S/D MALLANWALA	B453FL13	UJS ASSMAN WALA	AMR	OK	31.03.2023	Category 5 UPS	3570	1000-500/577/1-1-1	7,850	NA	Director/D			
B.12200	West	FEROZPUR	11KV	DS DIVN. ZIRA	DS S/D MALLANWALA	B474FL10	BASTI KRISHAL SINGH	AMR	OK	31.03.2023	AP 3Phase 3Wire	7336384	900-450/577/1-1-1	0,573	NA	Director/D			
B.12201	West	FEROZPUR	11KV	DS DIVN. ZIRA	DS S/D MALLANWALA	B474FL06	11KV WALTOHA AP	AMR	OK	31.03.2023	AP 3Phase 3Wire	777189	900-450/577/1-1-1	0,655	NA	Director/D			
B.12202	West	FEROZPUR	11KV	DS DIVN. ZIRA	DS S/D MALLANWALA	B474FL07	BHAGO KE AP	AMR	OK	31.03.2023	AP 3Phase 3Wire	8037302	900-450/577/1-1-1	1,556	NA	Director/D			
B.12203	West	FEROZPUR	11KV	DS DIVN. ZIRA	DS S/D MALLANWALA	B474FL08	11KV HETTE	NON AMR	OK	31.03.2023	AP 3Phase 3Wire	777250	900-450/577/1-1-1	1,800	NA	Director/D			
B.12204	West	FEROZPUR	11KV	DS DIVN. ZIRA	DS S/D MALLANWALA	B474FL09	BHAGO KE UPS	AMR	OK	31.03.2023	Category 5 UPS	8037300	900-450/577/1-1-1	5,613	NA	Director/D			
B.12205	West	FEROZPUR	11KV	DS DIVN. ZIRA	DS S/D MALLANWALA	B475FL03	KAMALA MIDHU	AMR	OK	31.03.2023	AP 3Phase 3Wire	777736	900-450/577/1-1-1	1,836	NA	Director/D			
B.12206	West	FEROZPUR	11KV	DS DIVN. ZIRA	DS S/D MALLANWALA	B475FL02	HAMMO CHAK	AMR	OK	31.03.2023	AP 3Phase 3Wire	7336716	900-450/577/1-1-1	2,425	NA	Director/D			
B.12207	West	FEROZPUR	11KV	DS DIVN. ZIRA	DS S/D MALLANWALA	B475FL06	11KV BUTABIN WALA+RUKNIE WALA	AMR	OK	31.03.2023	AP 3Phase 3Wire	7336708	900-450/577/1-1-1	2,625	NA	Director/D			
B.12208	West	FEROZPUR	11KV	DS DIVN. ZIRA	DS S/D MALLANWALA	B475FL05	11KV BANDALA	AMR	OK	31.03.2023	AP 3Phase 3Wire	777151	900-450/577/1-1-1	2,775	NA	Director/D			
B.12209	West	FEROZPUR	11KV	DS DIVN. ZIRA	DS S/D MALLANWALA	B475FL04	DHIRA GHARA	AMR	OK	31.03.2023	AP 3Phase 3Wire	7336116	900-450/577/1-1-1	2,927	NA	Director/D			
B.12210	West	FEROZPUR	11KV	DS DIVN. ZIRA	DS S/D MALLANWALA	B476FL07	UJS-2	NON AMR	OK	31.03.2023	Category 5 UPS	4941	900-450/577/1-1-1	7,007	NA	Director/D			
B.12211	West	FEROZPUR	11KV	DS DIVN. ZIRA	DS S/D MALLANWALA	B475FL01	UJS KAMALA MIDHU	AMR	OK	31.03.2023	Category 5 UPS	7336708	900-450/577/1-1-1	11,561	NA	Director/D			
B.12212	West	FEROZPUR	11KV	DS DIVN. ZIRA	DS S/D MALLANWALA	B475FL01	RHOSA DAI SINGH SUB STATION	AMR	OK	31.03.2023	Substation Transformer	5388132	900-450/577/1-1-1	0,032	NA	Director/D			
B.12213	West	FEROZPUR	11KV	DS DIVN. ZIRA	DS S/D MALLANWALA	B457FL08	ALPUR + JHEETE	AMR	OK	31.03.2023	AP 3Phase 3Wire	11069750	900-450/577/1-1-1	2,382	NA	Director/D			
B.12214	West	FEROZPUR	11KV	DS DIVN. ZIRA	DS S/D MALLANWALA	B457FL07	KOTHE + KOHALA	AMR	OK	31.03.2023	AP 3Phase 3Wire	934442	900-450/577/1-1-1	2,861	NA	Director/D			
B.12215	West	FEROZPUR	11KV	DS DIVN. ZIRA	DS S/D MALLANWALA	B457FL04	UJS CHUHLAK	AMR	OK	31.03.2023	Category 5 UPS	2067487	900-450/577/1-1-1	12,613	NA	Director/D			
B.12216	West	FEROZPUR	11KV	DS DIVN. ZIRA	DS S/D MALLANWALA	B469FL02	SUDHARA	AMR	OK	31.03.2023	AP 3Phase 3Wire	8223066	1200-600/577/1-1-1	1,156	NA	Director/D			
B.12217	West	FEROZPUR	11KV	DS DIVN. ZIRA	DS S/D MALLANWALA	B469FL01	RUKNIE WALA	AMR	OK	31.03.2023	AP 3Phase 3Wire	8223068	1200-600/577/1-1-1	1,504	NA	Director/D			
B.12218	West	FEROZPUR	11KV	DS DIVN. ZIRA	DS S/D MALLANWALA	B469FL08	KALUASH WALA OLD+NEW	AMR	OK	31.03.2023	AP 3Phase 3Wire	777251	1200-600/577/1-1-1	1,527	NA	Director/D			
B.12219	West	FEROZPUR	11KV	DS DIVN. ZIRA	DS S/D MALLANWALA	B469FL04	BASTI AMAR SINGH OLD NEW	AMR	OK	31.03.2023	AP 3Phase 3Wire	8223070	1200-600/577/1-1-1	2,045	NA	Director/D			
B.12220	West	FEROZPUR	11KV	DS DIVN. ZIRA	DS S/D MALLANWALA	B469FL05	GURDIT WALA	AMR	OK	31.03.2023	AP 3Phase 3Wire	778128	900-450/577/1-1-1	2,112	NA	Director/D			
B.12221	West	FEROZPUR	11KV	DS DIVN. ZIRA	DS S/D MALLANWALA	B469FL13	11KV ACHH WALA NEW/OLD	AMR	OK	31.03.2023	AP 3Phase 3Wire	11051981	1200-600/577/1-1-1	2,240	NA	Director/D			
B.12222	West	FEROZPUR	11KV	DS DIVN. ZIRA	DS S/D MALLANWALA	B469FL10	DULLA SINGH WALA OLD-NEW	AMR	OK	31.03.2023	AP 3Phase 3Wire	777831	1200-600/577/1-1-1	2,610	NA	Director/D			
B.12223	West	FEROZPUR	11KV	DS DIVN. ZIRA	DS S/D MALLANWALA	B469FL17	11KV BASTI AMAR SINGH NEW	AMR	OK	31.03.2023	AP 3Phase 3Wire	8223070	1200-600/577/1-1-1	2,715	NA	Director/D			
B.12224	West	FEROZPUR	11KV	DS DIVN. ZIRA	DS S/D MALLANWALA	B469FL07	KAMAL WALA	AMR	OK	31.03.2023	AP 3Phase 3Wire	777831	1200-600/577/1-1-1	3,086	NA	Director/D			
B.12225	West	FEROZPUR	11KV	DS DIVN. ZIRA	DS S/D MALLANWALA	B469FL09	ILME WALA OLD+NEW	NON AMR	OK	31.03.2023	AP 3Phase 3Wire	5437516	1200-600/577/1-1-1	3,102	NA	Director/D			
B.12226	West	FEROZPUR	11KV	DS DIVN. ZIRA	DS S/D MALLANWALA	B469FL14	Firozepur Road	AMR	OK	31.03.2023	Category 1	12497301	1200-600/577/1-1-1	3,379	NA	Director/D			
B.12227	West	FEROZPUR	11KV	DS DIVN. ZIRA	DS S/D MALLANWALA	B469FL15	MUV-2 FZR ROAD	NON AMR	OK	31.03.2023	Category 1	3885	900-450/577/1-1-1	6,727	NA	Director/D			
B.12228	West	FEROZPUR	11KV	DS DIVN. ZIRA	DS S/D MALLANWALA	B469FL12	11KV UPS-2 MELW	AMR	OK	31.03.2023	Category 5 UPS	11051980	1200-600/577/1-1-1	8,260	NA	Director/D			
B.12229	West	FEROZPUR	11KV	DS DIVN. ZIRA	DS S/D MALLANWALA	B469FL11	UJS MALLAN WALA	AMR	OK	31.03.2023	Category 1	12497301	1200-600/577/1-1-1	10,265	NA	Director/D			
B.12230	West	FEROZPUR	11KV	DS DIVN. ZIRA	DS S/D MALLANWALA	B469FL03	MALLAN WALA URBAN	AMR	OK	31.03.2023	Category 1	2994146	900-450/577/1-1-1	13,334	NA	Director/D			
B.12231	West	FEROZPUR	11KV	DS DIVN. ZIRA	DS S/D MALLANWALA	B454FL03	11KV MIAN SINGH WALA	AMR	OK	31.03.2023	AP 3Phase 3Wire	6679860	900-450/577/1-1-1	1,155	NA	Director/D			
B.12232	West	FEROZPUR	11KV	DS DIVN. ZIRA	DS S/D MALLANWALA	B454FL17	11KV NARABING SINGH WALA AP	AMR	OK	31.03.2023	AP 3Phase 3Wire	123123	900-450/577/1-1-1	2,286	NA	Director/D			
B.12233	West	FEROZPUR	11KV	DS DIVN. ZIRA	DS S/D MALLANWALA	B454FL04	LOHKA KHURD+VALTONA	AMR	OK	31.03.2023	AP 3Phase 3Wire	4221183	900-450/577/1-1-1	2,698	NA	Director/D			
B.12234	West	FEROZPUR	11KV	DS DIVN. ZIRA	DS S/D MALLANWALA	B454FL02	11KV NARABING SINGH WALA UPS	AMR	OK	31.03.2023	Category 5 UPS	9568112	900-450/577/1-1-1	4,718	NA	Director/D			
B.12235	West	FEROZPUR	11KV	DS DIVN. ZIRA	DS S/D MALLANWALA	B455FL05	ASHI KE	AMR	OK	31.03.2023	AP 3Phase 3Wire	5390819	1200-600/577/1-1-1	3,121	NA	Director/D			
B.12236	West	FEROZPUR	11KV	DS DIVN. ZIRA	DS S/D MALLANWALA	MAFSFL01	SUDH SINGH WALA	NON AMR	OK	31.03.2023	AP 3Phase 3Wire	777213	900-450/577/1-1-1	0,000	NA	Director/D			
B.12237	West	FEROZPUR	11KV	DS DIVN. ZIRA	DS S/D MALLANWALA	MAFSFL02	SUDH SINGH WALA UPS	NON AMR	OK	31.03.2023	Category 5 UPS	778117	900-450/577/1-1-1	0,000	NA	Director/D			
B.12238	West	FEROZPUR	11KV	DS DIVN. ZIRA	DS S/D MALLANWALA	MAFSFL04	BASTI BELA SINGH	AMR	OK	31.03.2023	Category 5 UPS	777214	900-450/577/1-1-1	0,000	NA	Director/D			
B.12239	West	FEROZPUR	11KV	DS DIVN. ZIRA	DS S/D TALWANDI BHAI	B453FL08	11KV MAHLA DRAIN AP	AMR	OK	31.03.2023	AP 3Phase 3Wire	1206330	900-450/577/1-1-1	1,436	NA	Director/D			
B.12240	West	FEROZPUR	11KV	DS DIVN. ZIRA	DS S/D TALWANDI BHAI	B453FL14	JOHANWALA	NON AMR	OK	31.03.2023	AP 3Phase 3Wire	8223332	900-450/577/1-1-1	2,181	NA	Director/D			
B.12241	West	FEROZPUR	11KV	DS DIVN. ZIRA	DS S/D TALWANDI BHAI	B452FL15	11KV MACHI BUGRA	AMR	OK	31.03.2023	AP 3Phase 3Wire	11114604	900-450/577/1-1-1	1,229	NA	Director/D			
B.12242	West	FEROZPUR	11KV	DS DIVN. ZIRA	DS S/D TALWANDI BHAI	B452FL04	KARMITI	AMR	OK	31.03.2023	AP 3Phase 3Wire	8223331	1200-600/577/1-1-1	1,483	NA	Director/D			
B.12243	West	FEROZPUR	11KV	DS DIVN. ZIRA	DS S/D TALWANDI BHAI	B452FL05	11KV DARAPUR	AMR	OK	31.03.2023	AP 3Phase 3Wire	777206	1200-600/577/1-1-1	1,579	NA	Director/D			
B.12244	West	FEROZPUR	11KV	DS DIVN. ZIRA	DS S/D TALWANDI BHAI	B452FL07	CHOTIAN	AMR	OK	31.03.2023	AP 3Phase 3Wire	8222554	900-450/577/1-1-1	1,877	NA	Director/D			
B.12245	West	FEROZPUR	11KV	DS DIVN. ZIRA	DS S/D TALWANDI BHAI	B452FL11	KULTIPURA	AMR	OK	31.03.2023	AP 3Phase 3Wire	8221251	1200-600/577/1-1-1	1,965	NA	Director/D			
B.12246	West	FEROZPUR	11KV	DS DIVN. ZIRA	DS S/D TALWANDI BHAI	B452FL14	11KV LALLEY AP	AMR	OK	31.03.2023	AP 3Phase 3Wire	5202	900-450/577/1-1-1	2,018	NA	Director/D			
B.12247	West	FEROZPUR	11KV	DS DIVN. ZIRA	DS S/D TALWANDI BHAI	B452FL02	11 KV JHANDANA	AMR	OK	31.03.2023	AP 3Phase 3Wire	777568	1200-600/577/1-1-1	2,037	NA	Director/D			
B.12248	West	FEROZPUR	11KV	DS DIVN. ZIRA	DS S/D TALWANDI BHAI	B452FL12	11KV HARRAJ	NON AMR	OK	31.03.2023	AP 3Phase 3Wire	114596	900-450/577/1-1-1	2,530	NA	Director/D			
B.12249	West	FEROZPUR	11KV	DS DIVN. ZIRA	DS S/D TALWANDI BHAI	B452FL19	MOGA ROAD	AMR	OK	31.03.2023	Category 1	778204	900-450/577/1-1-1	2,720	NA	Director/D			
B.12250	West	FEROZPUR	11KV	DS DIVN. ZIRA	DS S/D TALWANDI BHAI	B452FL01	11KV HIDE	NON AMR	OK	31.03.2023	AP 3Phase 3Wire	778206	1200-600/577/1-1-1	2,757	NA	Director/D			
B.12251	West	FEROZPUR	11KV	DS DIVN. ZIRA	DS S/D TALWANDI BHAI	B452FL09	11 KV MANDI URBAN	AMR	OK	31.03.2023	Category 1	4179483	1200-600/577/1-1-1	3,3					

S.No	Zone	Circle	Voltage Level (kVA)	Division (kVA)	Sub-Division (kVA)	Feeder ID	Feeder Name	Feeder Metering Status (Metered/unmetered/AMR/AMI)	Status of Meter (Functional/Non-functional)	Metering Date	Date of last actual meter reading/communication	Feeder Type (Agr/Industrial/Mixed)	Status of Communication				Period from 01.04.2021 to 31.03.2022				Sales	Remarks (Source of data)
													% data received through automatically if feeder AMR/AMI	Number of hours when meter was unable to communicate in period	Total Number of hours in the period	Meter S.No	CT/PT ratio	Import (kWh)	Export (kWh)			
B.12289	West	FEROZPUR	11KV	D5 DIVN. ZIRA	D5 S/D TALWANDI BHAI	D458FL05	PANDORI KHATRIAN	AMR	OK	31.03.2023		Category 5-UPS					10282992	1200-600/5	6.425	NA	Director/D	
B.12290	West	FEROZPUR	11KV	D5 DIVN. ZIRA	D5 S/D TALWANDI BHAI	D410FL08	LONGODEVA 1	AMR	OK	31.03.2023		AP 3Phase 3Wire					2065804	1200/577/1-1-1	1.292	NA	Director/D	
B.12291	West	FEROZPUR	11KV	D5 DIVN. ZIRA	D5 S/D TALWANDI BHAI	D410FL12	LONGODEVA 2	AMR	OK	31.03.2023		AP 3Phase 3Wire					1200/577/1-1-1	1.497	NA	Director/D		
B.12292	West	FEROZPUR	11KV	D5 DIVN. ZIRA	D5 S/D TALWANDI BHAI	D427FL16	11KV SADIH WALA 2	AMR	OK	31.03.2023		Category 5-UPS					2068126	1200-600/5	0.517	NA	Director/D	
B.12293	West	FEROZPUR	11KV	D5 DIVN. ZIRA	D5 S/D TALWANDI BHAI	D472FL05	11 KV DHANNA URBAN	AMR	OK	31.03.2023		Category 1					6745309	1200-600/5	1.054	NA	Director/D	
B.12294	West	FEROZPUR	11KV	D5 DIVN. ZIRA	D5 S/D TALWANDI BHAI	D472FL08	11KV SODHI WALA+RATOUAL ROHI	AMR	OK	31.03.2023		AP 3Phase 3Wire					23300	1200-600/5	2.109	NA	Director/D	
B.12295	West	FEROZPUR	11KV	D5 DIVN. ZIRA	D5 S/D TALWANDI BHAI	D472FL11	11KV HARAJ-II-SULHANI	AMR	OK	31.03.2023		AP 3Phase 3Wire					9568097	1200-600/5	2.664	NA	Director/D	
B.12296	West	FEROZPUR	11KV	D5 DIVN. ZIRA	D5 S/D TALWANDI BHAI	D472FL01	11KV RATOUAL ROHI+SADHU WALA-II	AMR	OK	31.03.2023		AP 3Phase 3Wire					77797	1200-600/5	2.695	NA	Director/D	
B.12297	West	FEROZPUR	11KV	D5 DIVN. ZIRA	D5 S/D TALWANDI BHAI	D472FL02	11 KV DHANNA SHAHID+WARA JWAR SJ	AMR	OK	31.03.2023		AP 3Phase 3Wire					11051962	1200-600/5	2.864	NA	Director/D	
B.12298	West	FEROZPUR	11KV	D5 DIVN. ZIRA	D5 S/D TALWANDI BHAI	D472FL06	11KV INDUSTRY	AMR	OK	31.03.2023		Category 2					5970	1200-600/5	3.095	NA	Director/D	
B.12299	West	FEROZPUR	11KV	D5 DIVN. ZIRA	D5 S/D TALWANDI BHAI	D472FL12	11KV SULHANI	AMR	OK	31.03.2023		AP 3Phase 3Wire					15193764	1200-600/5	3.353	NA	Director/D	
B.12300	West	FEROZPUR	11KV	D5 DIVN. ZIRA	D5 S/D TALWANDI BHAI	D472FL03	11 KV HARAJ I+ SADHU WALA	AMR	OK	31.03.2023		AP 3Phase 3Wire					9568117	1200-600/5	3.800	NA	Director/D	
B.12301	West	FEROZPUR	11KV	D5 DIVN. ZIRA	D5 S/D TALWANDI BHAI	D472FL04	11 KV TALWANDI BHAI CAT 2	NON AMR	OK	31.03.2023		Category 2					6679864	1200-600/5	6.991	NA	Director/D	
B.12302	West	FEROZPUR	11KV	D5 DIVN. ZIRA	D5 S/D TALWANDI BHAI	D472FL07	11 KV UPS DHANNA	AMR	OK	31.03.2023		Category 5-UPS					7338818	1200-600/5	7.804	NA	Director/D	
B.12303	West	FEROZPUR	11KV	D5 DIVN. ZIRA	D5 S/D TALWANDI BHAI	D472FL15	11KV SERKAWA UPS	AMR	OK	31.03.2023		Category 5-UPS					16184374	1200-600/5	8.367	NA	Director/D	
B.12304	West	FEROZPUR	11KV	D5 DIVN. ZIRA	D5 S/D TALWANDI BHAI	D485FL02	11KV NEHA AP	AMR	OK	31.03.2023		AP 3Phase 3Wire					198018	1200-600/5	0.808	NA	Director/D	
B.12305	West	FEROZPUR	11KV	D5 DIVN. ZIRA	D5 S/D TALWANDI BHAI	D485FL09	11KV HOLLAN WALI AP	AMR	OK	31.03.2023		AP 3Phase 3Wire					197925	1200-600/5	1.109	NA	Director/D	
B.12306	West	FEROZPUR	11KV	D5 DIVN. ZIRA	D5 S/D TALWANDI BHAI	D485FL03	11KV KARMU WALA AP	AMR	OK	31.03.2023		AP 3Phase 3Wire					198038	1200-600/5	1.338	NA	Director/D	
B.12307	West	FEROZPUR	11KV	D5 DIVN. ZIRA	D5 S/D TALWANDI BHAI	D485FL01	11KV UPS KARMU WALA	AMR	OK	31.03.2023		Category 5-UPS					20197907	1200-600/5	3.766	NA	Director/D	
B.12308	West	FEROZPUR	11KV	D5 DIVN. ZIRA	D5 S/D TALWANDI BHAI	B452FL11	11KV UPS-3 BOTIAN WALA	AMR	OK	31.03.2023		Category 5-UPS					8223665	900-450/5	0.027	NA	Director/D	
B.12309	West	FEROZPUR	11KV	D5 DIVN. ZIRA	D5 S/D ZIRA	B452FL05	BEHAK	NON AMR	OK	31.03.2023		AP 3Phase 3Wire					8223644	900-450/5	1.285	NA	Director/D	
B.12310	West	FEROZPUR	11KV	D5 DIVN. ZIRA	D5 S/D ZIRA	B452FL07	UPS	AMR	OK	31.03.2023		Category 5-UPS					5437701	900-450/5	1.287	NA	Director/D	
B.12311	West	FEROZPUR	11KV	D5 DIVN. ZIRA	D5 S/D ZIRA	B452FL13	11KV BOTIAN WALA-II	AMR	OK	31.03.2023		AP 3Phase 3Wire					8223641	900-450/5	1.475	NA	Director/D	
B.12312	West	FEROZPUR	11KV	D5 DIVN. ZIRA	D5 S/D ZIRA	B452FL03	NEW ZIRA	AMR	OK	31.03.2023		AP 3Phase 3Wire					8223641	900-450/5	1.548	NA	Director/D	
B.12313	West	FEROZPUR	11KV	D5 DIVN. ZIRA	D5 S/D ZIRA	B452FL01	BOTIAN WALA	AMR	OK	31.03.2023		AP 3Phase 3Wire					8223642	900-450/5	1.799	NA	Director/D	
B.12314	West	FEROZPUR	11KV	D5 DIVN. ZIRA	D5 S/D ZIRA	B452FL16	UPS FERD KE	NON AMR	OK	31.03.2023		Category 5-UPS					4439	900-450/5	1.964	NA	Director/D	
B.12315	West	FEROZPUR	11KV	D5 DIVN. ZIRA	D5 S/D ZIRA	B452FL09	11KV MEHAR SINGH WALA	AMR	OK	31.03.2023		AP 3Phase 3Wire					2045465	900-450/5	3.025	NA	Director/D	
B.12316	West	FEROZPUR	11KV	D5 DIVN. ZIRA	D5 S/D ZIRA	B452FL12	KOTHE GAORI WALA + NEELE WALA	AMR	OK	31.03.2023		AP 3Phase 3Wire					23456	900-450/5	3.684	NA	Director/D	
B.12317	West	FEROZPUR	11KV	D5 DIVN. ZIRA	D5 S/D ZIRA	B452FL02	FAROE	AMR	OK	31.03.2023		AP 3Phase 3Wire					838817	900-450/5	3.919	NA	Director/D	
B.12318	West	FEROZPUR	11KV	D5 DIVN. ZIRA	D5 S/D ZIRA	B452FL10	11KV UPS NO 2	NON AMR	OK	31.03.2023		Category 5-UPS					8223641	900-450/5	5.701	NA	Director/D	
B.12319	West	FEROZPUR	11KV	D5 DIVN. ZIRA	D5 S/D ZIRA	D473FL10	11KV MALSIAN	AMR	OK	31.03.2023		AP 3Phase 3Wire					12945	1200-600/5	0.268	NA	Director/D	
B.12320	West	FEROZPUR	11KV	D5 DIVN. ZIRA	D5 S/D ZIRA	D452FL16	11KV SHAH WALA-II	AMR	OK	31.03.2023		AP 3Phase 3Wire					3295545	1200-600/5	0.953	NA	Director/D	
B.12321	West	FEROZPUR	11KV	D5 DIVN. ZIRA	D5 S/D ZIRA	B452FL08	WARA POHWIND	AMR	OK	31.03.2023		AP 3Phase 3Wire					6669344	1200/577/1-1-1	1.605	NA	Director/D	
B.12322	West	FEROZPUR	11KV	D5 DIVN. ZIRA	D5 S/D ZIRA	B452FL10	TWO J.KHAN/JHATRA	AMR	OK	31.03.2023		AP 3Phase 3Wire					5295545	1200/577/1-1-1	1.620	NA	Director/D	
B.12323	West	FEROZPUR	11KV	D5 DIVN. ZIRA	D5 S/D ZIRA	D451FL18	11KV KAMALGARH	AMR	OK	31.03.2023		AP 3Phase 3Wire					8222615	1200/577/1-1-1	1.785	NA	Director/D	
B.12324	West	FEROZPUR	11KV	D5 DIVN. ZIRA	D5 S/D ZIRA	D451FL17	11KV BUMB	AMR	OK	31.03.2023		AP 3Phase 3Wire					12352	1200-600/5	1.851	NA	Director/D	
B.12325	West	FEROZPUR	11KV	D5 DIVN. ZIRA	D5 S/D ZIRA	D452FL11	SHAH WALA-I	AMR	OK	31.03.2023		AP 3Phase 3Wire					8223615	1200-600/5	2.077	NA	Director/D	
B.12326	West	FEROZPUR	11KV	D5 DIVN. ZIRA	D5 S/D ZIRA	D452FL14	11KV HULLE+HULLE-II	AMR	OK	31.03.2023		AP 3Phase 3Wire					1257230	1200/577/1-1-1	2.144	NA	Director/D	
B.12327	West	FEROZPUR	11KV	D5 DIVN. ZIRA	D5 S/D ZIRA	D451FL15	11KV BASTI PUNJAB SINGH+BUMB	AMR	OK	31.03.2023		AP 3Phase 3Wire					5390813	1200-600/5	2.380	NA	Director/D	
B.12328	West	FEROZPUR	11KV	D5 DIVN. ZIRA	D5 S/D ZIRA	D451FL04	KATORA	AMR	OK	31.03.2023		AP 3Phase 3Wire					7386422	1200/577/1-1-1	3.057	NA	Director/D	
B.12329	West	FEROZPUR	11KV	D5 DIVN. ZIRA	D5 S/D ZIRA	B452FL15	11KV UPS NO 3	AMR	OK	31.03.2023		Category 5-UPS					3957	1200-600/5	3.365	NA	Director/D	
B.12330	West	FEROZPUR	11KV	D5 DIVN. ZIRA	D5 S/D ZIRA	D451FL07	PANDORI JATTAN	AMR	OK	31.03.2023		AP 3Phase 3Wire					5342140	1200/577/1-1-1	4.009	NA	Director/D	
B.12331	West	FEROZPUR	11KV	D5 DIVN. ZIRA	D5 S/D ZIRA	D451FL09	KAMALGARH	AMR	OK	31.03.2023		Category 5-UPS					2061709	1200-600/5	3.466	NA	Director/D	
B.12332	West	FEROZPUR	11KV	D5 DIVN. ZIRA	D5 S/D ZIRA	D473FL01	KASSONA	AMR	OK	31.03.2023		AP 3Phase 3Wire					8223220	900-450/5	0.000	NA	Director/D	
B.12333	West	FEROZPUR	11KV	D5 DIVN. ZIRA	D5 S/D ZIRA	D473FL05	NEELAWALA	AMR	OK	31.03.2023		AP 3Phase 3Wire					8223218	900-450/5	0.019	NA	Director/D	
B.12334	West	FEROZPUR	11KV	D5 DIVN. ZIRA	D5 S/D ZIRA	D473FL03	MALLESHAH	NON AMR	OK	31.03.2023		AP 3Phase 3Wire					778199	900-450/5	1.816	NA	Director/D	
B.12335	West	FEROZPUR	11KV	D5 DIVN. ZIRA	D5 S/D ZIRA	D473FL06	11KV URBAN NEW	AMR	OK	31.03.2023		Category 1					12099356	900-450/5	2.180	NA	Director/D	
B.12336	West	FEROZPUR	11KV	D5 DIVN. ZIRA	D5 S/D ZIRA	D473FL05	KASSONA 2	AMR	OK	31.03.2023		AP 3Phase 3Wire					30479	900-450/57/1-1-1	3.266	NA	Director/D	
B.12337	West	FEROZPUR	11KV	D5 DIVN. ZIRA	D5 S/D ZIRA	D473FL04	WAKILA WALA	NON AMR	OK	31.03.2023		AP 3Phase 3Wire					3028	900-450/577/1-1-1	3.819	NA	Director/D	
B.12338	West	FEROZPUR	11KV	D5 DIVN. ZIRA	D5 S/D ZIRA	D473FL02	UPS KASSONA	AMR	OK	31.03.2023		Category 5-UPS					8223220	900-450/5	6.402	NA	Director/D	
B.12339	West	FEROZPUR	11KV	D5 DIVN. ZIRA	D5 S/D ZIRA	D457FL09	MARKHAI	AMR	OK	31.03.2023		AP 3Phase 3Wire					6669352	900-450/5	1.204	NA	Director/D	
B.12340	West	FEROZPUR	11KV	D5 DIVN. ZIRA	D5 S/D ZIRA	D457FL17	11KV MARKHAI NEW AP	AMR	OK	31.03.2023		AP 3Phase 3Wire					777203	900-450/5	1.690	NA	Director/D	
B.12341	West	FEROZPUR	11KV	D5 DIVN. ZIRA	D5 S/D ZIRA	D457FL06	KACHHARBHAN	AMR	OK	31.03.2023		AP 3Phase 3Wire					8223327	900-450/5	3.116	NA	Director/D	
B.12342	West	FEROZPUR	11KV	D5 DIVN. ZIRA	D5 S/D ZIRA	D457FL13	SANTY WALA	AMR	OK	31.03.2023		Category 1					8223397	900-450/5	3.299	NA	Director/D	
B.12343	West	FEROZPUR	11KV	D5 DIVN. ZIRA	D5 S/D ZIRA	D457FL05	SUGAR MILL	NON AMR	OK	31.03.2023		Category 1					21327	1200-600/5	0.768	NA	Director/D	
B.12344	West	FEROZPUR																				

S.No	Zone	Circle	Voltage Level (kVA)	Division (kVA)	Sub-Division (kVA)	Feeder ID	Feeder Name	Feeder Metering Status (Metered/unmetered/AMR/AMI)	Status of Meter (Functional/Non-Functional)	Metering Date (Date of last actual meter reading/communication)	Feeder Type (Agr/Industrial/Mixed)	Status of Communication		Period from 01.04.2021 to 31.03.2022				Sales	Remarks (Source of data)
												% data received through automatically by feeder AMR/AMI	Number of hours when meter was unable to communicate in overall	Total Number of hours in the period	Meter S.No	CT/PT ratio	Import (kWh)		
B.12386	West	FEROZPUR	11KV	DS S/U DIVN. FEROZPUR	DS S/D JHOK HARI HAR	E456FL15	11 KV NASEERA KHALCHIA	AMR	OK	31.03.2023	AP 3Phase 3Wire			11117220	1200-600/5	1,378	NA	Director/D	
B.12387	West	FEROZPUR	11KV	DS S/U DIVN. FEROZPUR	DS S/D JHOK HARI HAR	E456FL04	CHUGE WALA	AMR	OK	31.03.2023	AP 3Phase 3Wire			8223813	Not installed	1,390	NA	Director/D	
B.12388	West	FEROZPUR	11KV	DS S/U DIVN. FEROZPUR	DS S/D JHOK HARI HAR	E456FL11	MOHRE WALA	NON AMR	OK	31.03.2023	AP 3Phase 3Wire			5386125	1200-600/5	1,482	NA	Director/D	
B.12389	West	FEROZPUR	11KV	DS S/U DIVN. FEROZPUR	DS S/D JHOK HARI HAR	E456FL14	11 KV KORNAN WAL	AMR	OK	31.03.2023	AP 3Phase 3Wire			11117314	1200-600/5	1,517	NA	Director/D	
B.12390	West	FEROZPUR	11KV	DS S/U DIVN. FEROZPUR	DS S/D JHOK HARI HAR	E456FL05	DOO	AMR	OK	31.03.2023	AP 3Phase 3Wire			23713	Not installed	1,552	NA	Director/D	
B.12391	West	FEROZPUR	11KV	DS S/U DIVN. FEROZPUR	DS S/D JHOK HARI HAR	E456FL02	GOBINO NAGAR	AMR	OK	31.03.2023	AP 3Phase 3Wire			8223811	Not installed	1,612	NA	Director/D	
B.12392	West	FEROZPUR	11KV	DS S/U DIVN. FEROZPUR	DS S/D JHOK HARI HAR	E456FL01	MALLU WALA	AMR	OK	31.03.2023	AP 3Phase 3Wire			4421045	Not installed	1,766	NA	Director/D	
B.12393	West	FEROZPUR	11KV	DS S/U DIVN. FEROZPUR	DS S/D JHOK HARI HAR	E456FL12	FATU WALA UPS	NON AMR	OK	31.03.2023	Category 5-UPS			11117320	1200-600/5	2,687	NA	Director/D	
B.12394	West	FEROZPUR	11KV	DS S/U DIVN. FEROZPUR	DS S/D JHOK HARI HAR	E456FL08	UPS DABRA PATRA	NON AMR	OK	31.03.2023	Category 5-UPS			2067256	1200-600/5	4,266	NA	Director/D	
B.12395	West	FEROZPUR	11KV	DS S/U DIVN. FEROZPUR	DS S/D JHOK HARI HAR	E456FL16	URBAN JHOK HARI HAR	AMR	OK	31.03.2023	Category 5-UPS			9154256	1200-600/5	6,268	NA	Director/D	
B.12396	West	FEROZPUR	11KV	DS S/U DIVN. FEROZPUR	DS S/D JHOK HARI HAR	E456FL17	BHAWARA AZAM SHAH	AMR	OK	31.03.2023	Category 5-UPS			3518	1200-600/5	5,445	NA	Director/D	
B.12397	West	FEROZPUR	11KV	DS S/U DIVN. FEROZPUR	DS S/D JHOK HARI HAR	E456FL07	URBAN MEHAMA	AMR	OK	31.03.2023	Category 5-UPS			7035631	Not installed	7,255	NA	Director/D	
B.12398	West	FEROZPUR	11KV	DS S/U DIVN. FEROZPUR	DS S/D JHOK HARI HAR	E457FL10	HASSAN DUTT	AMR	OK	31.03.2023	AP 3Phase 3Wire			30257	200-100/5-5	1,951	NA	Director/D	
B.12399	West	FEROZPUR	11KV	DS S/U DIVN. FEROZPUR	DS S/D JHOK HARI HAR	0403FL07	CHAK JAMIT SINGH WALA	AMR	OK	31.03.2023	AP 3Phase 3Wire			8222569	1200/ 577/1-1-1	1,862	NA	Director/D	
B.12400	West	FEROZPUR	11KV	DS S/U DIVN. FEROZPUR	DS S/D JHOK HARI HAR	0403FL09	LOHARA NAWAB	AMR	OK	31.03.2023	AP 3Phase 3Wire			33479	1200/ 577/1-1-1	1,978	NA	Director/D	
B.12401	West	FEROZPUR	11KV	DS S/U DIVN. FEROZPUR	DS S/D JHOK HARI HAR	0403FL12	THEM GUZAR	AMR	OK	31.03.2023	Category 5-UPS			3510	1200/ 577/1-1-1	3,225	NA	Director/D	
B.12402	West	FEROZPUR	11KV	DS S/U DIVN. FEROZPUR	DS S/D JHOK HARI HAR	0403FL03	CHAK HARAZ BARKA	AMR	OK	31.03.2023	Category 5-UPS			7336589	1200/ 577/1-1-1	4,212	NA	Director/D	
B.12403	West	FEROZPUR	11KV	DS S/U DIVN. FEROZPUR	DS S/D JHOK HARI HAR	0407FL04	ALI KE	NON AMR	OK	31.03.2023	AP 3Phase 3Wire			23302	1200/ 577/1-1-1	1,301	NA	Director/D	
B.12404	West	FEROZPUR	11KV	DS S/U DIVN. FEROZPUR	DS S/D JHOK HARI HAR	0407FL02	PARGAT SAHIR	NON AMR	OK	31.03.2023	Category 5-UPS			23303	1200/ 577/1-1-1	1,772	NA	Director/D	
B.12405	West	FEROZPUR	11KV	DS S/U DIVN. FEROZPUR	DS S/D JHOK HARI HAR	0407FL03	LODHRA	NON AMR	OK	31.03.2023	AP 3Phase 3Wire			23317	1200/ 577/1-1-1	2,367	NA	Director/D	
B.12406	West	FEROZPUR	11KV	DS S/U DIVN. FEROZPUR	DS S/D JHOK HARI HAR	0407FL07	HARGOBINDO PUNH	AMR	OK	31.03.2023	Category 5-UPS			34242	1200/ 577/1-1-1	5,809	NA	Director/D	
B.12407	West	FEROZPUR	11KV	DS S/U DIVN. FEROZPUR	DS S/D JHOK HARI HAR	0462FL01	HAMAD	AMR	OK	31.03.2023	AP 3Phase 3Wire			8222866	900-450/5	0,000	NA	Director/D	
B.12408	West	FEROZPUR	11KV	DS S/U DIVN. FEROZPUR	DS S/D JHOK HARI HAR	0462FL15	KARI KALAN	NON AMR	OK	31.03.2023	AP 3Phase 3Wire			15196134	900-450/5	0,776	NA	Director/D	
B.12409	West	FEROZPUR	11KV	DS S/U DIVN. FEROZPUR	DS S/D JHOK HARI HAR	0462FL03	JHOK HARI SINGH G-5	AMR	OK	31.03.2023	Category 1			10282927	900-450/5	1,144	NA	Director/D	
B.12410	West	FEROZPUR	11KV	DS S/U DIVN. FEROZPUR	DS S/D JHOK HARI HAR	0462FL08	KILLI	AMR	OK	31.03.2023	AP 3Phase 3Wire			8222867	900-450/5	1,573	NA	Director/D	
B.12411	West	FEROZPUR	11KV	DS S/U DIVN. FEROZPUR	DS S/D JHOK HARI HAR	0462FL07	BURI MAKHAN SINGH	AMR	OK	31.03.2023	AP 3Phase 3Wire			10282945	900-450/5	1,728	NA	Director/D	
B.12412	West	FEROZPUR	11KV	DS S/U DIVN. FEROZPUR	DS S/D JHOK HARI HAR	0462FL07	LAKHO KE	AMR	OK	31.03.2023	AP 3Phase 3Wire			778129	900-450/5	1,755	NA	Director/D	
B.12413	West	FEROZPUR	11KV	DS S/U DIVN. FEROZPUR	DS S/D JHOK HARI HAR	0462FL13	SOPHI WALA	AMR	OK	31.03.2023	AP 3Phase 3Wire			15196128	900-450/5	1,760	NA	Director/D	
B.12414	West	FEROZPUR	11KV	DS S/U DIVN. FEROZPUR	DS S/D JHOK HARI HAR	0462FL02	SHAM SINGH WALA	AMR	OK	31.03.2023	AP 3Phase 3Wire			5437715	900-450/5	1,814	NA	Director/D	
B.12415	West	FEROZPUR	11KV	DS S/U DIVN. FEROZPUR	DS S/D JHOK HARI HAR	0462FL11	PHULLAR WAN	AMR	OK	31.03.2023	AP 3Phase 3Wire			2067310	900-450/5	1,859	NA	Director/D	
B.12416	West	FEROZPUR	11KV	DS S/U DIVN. FEROZPUR	DS S/D JHOK HARI HAR	0462FL05	TARE WALA	AMR	OK	31.03.2023	AP 3Phase 3Wire			777837	900-450/5	1,997	NA	Director/D	
B.12417	West	FEROZPUR	11KV	DS S/U DIVN. FEROZPUR	DS S/D JHOK HARI HAR	0462FL10	DIA RAM	NON AMR	OK	31.03.2023	AP 3Phase 3Wire			11117215	900-450/5	2,006	NA	Director/D	
B.12418	West	FEROZPUR	11KV	DS S/U DIVN. FEROZPUR	DS S/D JHOK HARI HAR	0462FL06	ALJU KE	AMR	OK	31.03.2023	AP 3Phase 3Wire			8222868	900-450/5	2,245	NA	Director/D	
B.12419	West	FEROZPUR	11KV	DS S/U DIVN. FEROZPUR	DS S/D JHOK HARI HAR	0462FL12	JUNG	AMR	OK	31.03.2023	Category 5-UPS			7336425	900-450/5	5,716	NA	Director/D	
B.12420	West	FEROZPUR	11KV	DS S/U DIVN. FEROZPUR	DS S/D JHOK HARI HAR	0462FL14	TOOR	AMR	OK	31.03.2023	Category 5-UPS			15196133	900-450/5	7,621	NA	Director/D	
B.12421	West	FEROZPUR	11KV	DS S/U DIVN. FEROZPUR	DS S/D MAMDOT	0461FL25	11 KV KALLU ARRIAN	AMR	OK	31.03.2023	AP 3Phase 3Wire			2993260	900-450/5	0,532	NA	Director/D	
B.12422	West	FEROZPUR	11KV	DS S/U DIVN. FEROZPUR	DS S/D MAMDOT	0461FL20	BAHME KE	AMR	OK	31.03.2023	AP 3Phase 3Wire			19104667	1200/ 577/1-1-1	0,527	NA	Director/D	
B.12423	West	FEROZPUR	11KV	DS S/U DIVN. FEROZPUR	DS S/D MAMDOT	0461FL22	KALU ABBIAN	AMR	OK	31.03.2023	AP 3Phase 3Wire			15194646	1200/ 577/1-1-1	1,044	NA	Director/D	
B.12424	West	FEROZPUR	11KV	DS S/U DIVN. FEROZPUR	DS S/D MAMDOT	0461FL05	GATTI HAYAT	AMR	OK	31.03.2023	AP 3Phase 3Wire			7030168	900-450/5	1,225	NA	Director/D	
B.12425	West	FEROZPUR	11KV	DS S/U DIVN. FEROZPUR	DS S/D MAMDOT	0461FL02	KARMA	AMR	OK	31.03.2023	AP 3Phase 3Wire			2046477	900-450/5	1,507	NA	Director/D	
B.12426	West	FEROZPUR	11KV	DS S/U DIVN. FEROZPUR	DS S/D MAMDOT	0461FL10	11 KV CHAPATI	AMR	OK	31.03.2023	AP 3Phase 3Wire			2046878	900-450/5	1,572	NA	Director/D	
B.12427	West	FEROZPUR	11KV	DS S/U DIVN. FEROZPUR	DS S/D MAMDOT	0461FL24	11 KV AP GATTI MATTAR	AMR	OK	31.03.2023	AP 3Phase 3Wire			2046541	900-450/5	1,609	NA	Director/D	
B.12428	West	FEROZPUR	11KV	DS S/U DIVN. FEROZPUR	DS S/D MAMDOT	0461FL21	11 KV BAWALA	AMR	OK	31.03.2023	AP 3Phase 3Wire			15794658	1200/ 577/1-1-1	1,621	NA	Director/D	
B.12429	West	FEROZPUR	11KV	DS S/U DIVN. FEROZPUR	DS S/D MAMDOT	0461FL13	11 KV SWAL KE	AMR	OK	31.03.2023	AP 3Phase 3Wire			2066301	900-450/5	1,629	NA	Director/D	
B.12430	West	FEROZPUR	11KV	DS S/U DIVN. FEROZPUR	DS S/D MAMDOT	0461FL07	11 KV LAKHA SINGH WALA	AMR	OK	31.03.2023	AP 3Phase 3Wire			778068	1200/ 577/1-1-1	1,759	NA	Director/D	
B.12431	West	FEROZPUR	11KV	DS S/U DIVN. FEROZPUR	DS S/D MAMDOT	0461FL03	KAKKAR	AMR	OK	31.03.2023	AP 3Phase 3Wire			2046451	900-450/5	1,767	NA	Director/D	
B.12432	West	FEROZPUR	11KV	DS S/U DIVN. FEROZPUR	DS S/D MAMDOT	0461FL06	SETHAN WALA	AMR	OK	31.03.2023	AP 3Phase 3Wire			777635	900-450/5	1,799	NA	Director/D	
B.12433	West	FEROZPUR	11KV	DS S/U DIVN. FEROZPUR	DS S/D MAMDOT	0461FL09	RAJ SINGH WALA	AMR	OK	31.03.2023	AP 3Phase 3Wire			7780772	900-450/5	1,806	NA	Director/D	
B.12434	West	FEROZPUR	11KV	DS S/U DIVN. FEROZPUR	DS S/D MAMDOT	0461FL11	11 KV HAZARA SINGH WALA	AMR	OK	31.03.2023	AP 3Phase 3Wire			777634	900-450/5	1,873	NA	Director/D	
B.12435	West	FEROZPUR	11KV	DS S/U DIVN. FEROZPUR	DS S/D MAMDOT	0461FL01	NAWAN KILLA	AMR	OK	31.03.2023	AP 3Phase 3Wire			2991451	900-450/5	2,011	NA	Director/D	
B.12436	West	FEROZPUR	11KV	DS S/U DIVN. FEROZPUR	DS S/D MAMDOT	0461FL18	JALLO KE	AMR	OK	31.03.2023	AP 3Phase 3Wire			8222303	900-450/5	2,186	NA	Director/D	
B.12437	West	FEROZPUR	11KV	DS S/U DIVN. FEROZPUR	DS S/D MAMDOT	0461FL19	JATALA	NON AMR	OK	31.03.2023	AP 3Phase 3Wire			15194644	1200/ 577/1-1-1	2,578	NA	Director/D	
B.12438	West	FEROZPUR	11KV	DS S/U DIVN. FEROZPUR	DS S/D MAMDOT	0461FL04	BOO	NON AMR	OK	31.03.2023	Category 4			2994159	900-450/5	2,794	NA	Director/D	
B.12439	West	FEROZPUR	11KV	DS S/U DIVN. FEROZPUR	DS S/D MAMDOT	0461FL16	11 KV FOCAL POINT	NON AMR	OK	31.03.2023	Category 5-UPS			2067248	900-450/5	2,821	NA	Director/D	
B.12440	West	FEROZPUR	11KV	DS S/U DIVN. FEROZPUR	DS S/D MAMDOT	0461FL08	TOWN	AMR	OK	31.03.2023	Category 1			2992728	900-450/5	3,048	NA	Director/D	
B.12441	West	FEROZPUR	11KV	DS S/U DIVN. FEROZPUR	DS S/D MAMDOT	0461FL17	11 KV RAD KE	AMR	OK	31.03.2023	Category 5-UPS			5342514	900-450/5	3,196	NA	Director/D	
B.12442	West	FEROZPUR	11KV	DS S/U DIVN. FEROZPUR	DS S/D MAMDOT	0461FL03	G-5	AMR	OK	31.03.2023	Category 4			15196105	900-450/ 577/1-1-1	1,622	NA	Director/D	
B.12443	West	FEROZPUR	11KV	DS S/U DIVN. FEROZPUR	DS S/D MAMDOT	484FL05	TIBBA	AMR	OK	31.03.2023	AP 3Phase 3Wire			5287	900-450/ 577/1-1-1	1,728	NA	Director/D	
B.12444	West	FEROZPUR	11KV	DS S/U DIVN. FEROZPUR	DS S/D MAMDOT	0461FL04	KOTHE KILL WALA	AMR	OK	31.03.2023	AP 3Phase 3Wire			7780289	900-450/ 577/1-1-1	1,865	NA	Director/D	
B.12445	West	FEROZPUR	11KV	DS S/U DIVN. FEROZPUR	DS S/D MAMDOT	0461FL02	BOBBI KE	AMR	OK	31.03.2023	AP 3Phase 3Wire			15196599	900-450/ 577/1-1-1	1,948	NA	Director/D	
B.12446	West	FEROZPUR	11KV	DS S/U DIVN. FEROZPUR	DS S/D MAMDOT	0461FL01	NANANSIR	AMR	OK	31.03.2023	Category 5-UPS			15199025	900-450/ 577/1-1-1	13,336	NA	Director/D	
B.12447	West	FEROZPUR	11KV	DS S/U DIVN. FEROZPUR	DS S/D MAMDOT	0461FL09	Baba sher shah wali	AMR	OK	31.03.2023	AP 3Phase 3Wire			4394	1200/ 577/1-1-1	1,431	NA	Director/D	
B.12448	West	FEROZPUR	11KV	DS S/U DIVN. FEROZPUR	DS S/D MAMDOT	0461FL07	BASTI HAZARA SINGH	AMR	OK	31.03.2023	AP 3Phase 3Wire			15196136	1200/ 577/1-1-1	1,551	NA	Director/D	
B.12449	West	FEROZPUR	11KV	DS S/U DIVN. FEROZPUR	DS S/D MAMDOT	0461FL02	JANDPER	AMR	OK	31.03.2023	AP 3Phase 3Wire			23170	1200/ 577/1-1-1	1,557	NA	Director/D	
B.12450	West	FEROZPUR	11KV	DS S/U DIVN. FEROZPUR	DS S/D MAMDOT	0461FL03	BOBBI KHATTAR	AMR	OK	31.03.2023	AP 3Phase 3Wire			23212	1200/ 577/1-1-1</				

S.No	Zone	Circle	Voltage Level (kVA)	Division (kVA)	Sub-Division (kVA)	Feeder ID	Feeder Name	Feeder Metering Status (Meters/Numbered/AM/AMR)	Status of Meter (Functional/Non-Functional)	Metering Date (Date of last actual meter reading/communication)	Feeder Type (Agr./Industrial/Mixed)	Status of Communication			Period from 01.04.2021 to 31.03.2022				Sales	Remarks (Source of data)
												% data received through automatically by feeder AMR/AMI	Number of hours when meter was unable to communicate in overall	Total Number of hours in the period	Meter S.No	CT/PT ratio	Import (kU)	Export (kU)		
B.12483	West	MUKATSAR	11KV	DS DIVN. ABOHAR	DS S/D KHUIAN SARWAR	NA01F05	New Patrewala UPS	AMR	OK	31.03.2023	Category 5-UPS				4524	900-450/577/1-1-1	6.044	NA	Director/D	
B.12484	West	MUKATSAR	11KV	DS DIVN. ABOHAR	DS S/D KHUIAN SARWAR	ES29F03	BHANGER KHERA	AMR	OK	31.03.2023	AP 3Phase 3WIr				5341554	400-200/5-5	0.216	NA	Director/D	
B.12485	West	MUKATSAR	11KV	DS DIVN. ABOHAR	DS S/D KHUIAN SARWAR	ES29F04	USMAN KHERA	AMR	OK	31.03.2023	AP 3Phase 3WIr				2994147	400-200/5-5	0.627	NA	Director/D	
B.12486	West	MUKATSAR	11KV	DS DIVN. ABOHAR	DS S/D KHUIAN SARWAR	ES29F01	11 KALLER KHERA	AMR	OK	31.03.2023	Category 1				2667465	400-200/5-5	4.638	NA	Director/D	
B.12487	West	MUKATSAR	11KV	DS DIVN. ABOHAR	DS S/D KHUIAN SARWAR	ES29F05	11 KV Ganganagar Road	AMR	OK	31.03.2023	Category 5-UPS				8222816	400-200/5-5	7.314	NA	Director/D	
B.12488	West	MUKATSAR	11KV	DS DIVN. ABOHAR	DS S/D KHUIAN SARWAR	ES29F02	JANDWALA HANUWANTA	AMR	OK	31.03.2023	Category 5-UPS				5388147	400-200/5-5	7.986	NA	Director/D	
B.12489	West	MUKATSAR	11KV	DS DIVN. ABOHAR	DS S/D KHUIAN SARWAR	ES29F06	11 KV Punjwa Model	AMR	OK	31.03.2023	Category 5-UPS				8153574	400-200/5-5	9.640	NA	Director/D	
B.12490	West	MUKATSAR	11KV	DS DIVN. ABOHAR	DS S/D KHUIAN SARWAR	ES29F02	HARIPURA	AMR	OK	31.03.2023	AP 3Phase 3WIr				6761886	900-450/5	0.473	NA	Director/D	
B.12491	West	MUKATSAR	11KV	DS DIVN. ABOHAR	DS S/D KHUIAN SARWAR	ES29F05	MAJUWARI	AMR	OK	31.03.2023	AP 3Phase 3WIr				4221166	400-200/5-5	0.476	NA	Director/D	
B.12492	West	MUKATSAR	11KV	DS DIVN. ABOHAR	DS S/D KHUIAN SARWAR	ES29F04	NEFD	AMR	OK	31.03.2023	Category 5-UPS				2067671	900-450/5	3.833	NA	Director/D	
B.12493	West	MUKATSAR	11KV	DS DIVN. ABOHAR	DS S/D KHUIAN SARWAR	ES29F01	DALMIR KHERA	AMR	OK	31.03.2023	Category 5-UPS				6745296	900-450/5	9.202	NA	Director/D	
B.12494	West	MUKATSAR	11KV	DS DIVN. ABOHAR	DS S/D KHUIAN SARWAR	ES29F06	PANIKOSI	AMR	OK	31.03.2023	Category 5-UPS				2067168	400-200/5-5	9.707	NA	Director/D	
B.12495	West	MUKATSAR	11KV	DS DIVN. ABOHAR	DS S/D KHUIAN SARWAR	TS23F08	DALUATPURA UPS	AMR	OK	31.03.2023	Category 5-UPS				11117170	900-450/5	9.895	NA	Director/D	
B.12496	West	MUKATSAR	11KV	DS DIVN. ABOHAR	DS S/D KHUIAN SARWAR	0542F08	11 KV Khipgamwalli	AMR	OK	31.03.2023	AP 3Phase 3WIr				4982	1200-600/5	0.845	NA	Director/D	
B.12497	West	MUKATSAR	11KV	DS DIVN. ABOHAR	DS S/D KHUIAN SARWAR	0542F03	11 KV Jandwala Meerasingla	AMR	OK	31.03.2023	AP 3Phase 3WIr				9154220	1200-600/5	1.867	NA	Director/D	
B.12498	West	MUKATSAR	11KV	DS DIVN. ABOHAR	DS S/D KHUIAN SARWAR	0542F04	11 KV Bareka	AMR	OK	31.03.2023	AP 3Phase 3WIr				778085	1200-600/5	2.154	NA	Director/D	
B.12499	West	MUKATSAR	11KV	DS DIVN. ABOHAR	DS S/D KHUIAN SARWAR	0542F07	11 KV Patrewala	AMR	OK	31.03.2023	Category 5-UPS				6669362	1200-600/5	10.339	NA	Director/D	
B.12500	West	MUKATSAR	11KV	DS DIVN. ABOHAR	DS S/D NO. 1 ABOHAR	CS06F16	11 KV Airforce	AMR	OK	31.03.2023	Category 2				9568188	1200-600/5	0.243	NA	Director/D	
B.12501	West	MUKATSAR	11KV	DS DIVN. ABOHAR	DS S/D NO. 1 ABOHAR	CS06F13	WATER WORKS	AMR	OK	31.03.2023	Category 1				9568142	1200-600/5	1.878	NA	Director/D	
B.12502	West	MUKATSAR	11KV	DS DIVN. ABOHAR	DS S/D NO. 1 ABOHAR	CS06F14	11 KV Model Town	AMR	OK	31.03.2023	Category 1				9568144	1200-600/5	6.398	NA	Director/D	
B.12503	West	MUKATSAR	11KV	DS DIVN. ABOHAR	DS S/D NO. 1 ABOHAR	CS06F19	Sto Road	AMR	OK	31.03.2023	Category 1				1955101	1200-600/5	7.342	NA	Director/D	
B.12504	West	MUKATSAR	11KV	DS DIVN. ABOHAR	DS S/D NO. 1 ABOHAR	CS06F08	11 KV Town	NON AMR	OK	31.03.2023	Category 1				9568235	1200-600/5	9.743	NA	Director/D	
B.12505	West	MUKATSAR	11KV	DS DIVN. ABOHAR	DS S/D NO. 1 ABOHAR	CS06F18	Bus Stand Road	AMR	OK	31.03.2023	Category 1				5446564	1200-600/5	10.571	NA	Director/D	
B.12506	West	MUKATSAR	11KV	DS DIVN. ABOHAR	DS S/D NO. 1 ABOHAR	CS06F05	FALZKA ROAD	AMR	OK	31.03.2023	Category 1				9568170	1200-600/5	11.031	NA	Director/D	
B.12507	West	MUKATSAR	11KV	DS DIVN. ABOHAR	DS S/D NO. 1 ABOHAR	CS06F10	INDUSTRIAL	AMR	OK	31.03.2023	Category 1				9568102	1200-600/5	13.504	NA	Director/D	
B.12508	West	MUKATSAR	11KV	DS DIVN. ABOHAR	DS S/D NO. 1 ABOHAR	CS06F06	LINK NO. 1	AMR	OK	31.03.2023	Category 1				9568169	1200-600/5	15.391	NA	Director/D	
B.12509	West	MUKATSAR	11KV	DS DIVN. ABOHAR	DS S/D NO. 1 ABOHAR	ES21F02	KRISHNA NAGRI	AMR	OK	31.03.2023	Category 1				9141098	900-450/5	7.346	NA	Director/D	
B.12510	West	MUKATSAR	11KV	DS DIVN. ABOHAR	DS S/D NO. 1 ABOHAR	ES21F07	INDRA NAGRI	NON AMR	OK	31.03.2023	Category 1				8233714	900-450/5	7.913	NA	Director/D	
B.12511	West	MUKATSAR	11KV	DS DIVN. ABOHAR	DS S/D NO. 1 ABOHAR	ES21F12	11 KV Circular Road	Not available	OK	31.03.2023	Category 1				2964	900-450/5	8.888	NA	Director/D	
B.12512	West	MUKATSAR	66KV	DS DIVN. ABOHAR	DS S/D NO. 1 ABOHAR	CS06E06	66 KV MES	AMR	OK	31.03.2023	Category 2				Not available	Not available	5.988	NA	Director/D	
B.12513	West	MUKATSAR	11KV	DS DIVN. ABOHAR	DS S/D NO. 2 ABOHAR	CS06F11	11 KV KALA TIBBA	AMR	OK	31.03.2023	AP 3Phase 3WIr				3	1200-800/5	1.298	NA	Director/D	
B.12514	West	MUKATSAR	11KV	DS DIVN. ABOHAR	DS S/D NO. 2 ABOHAR	CS06F17	Phakra	AMR	OK	31.03.2023	Category 5-UPS				1955883	1200-600/5	4.438	NA	Director/D	
B.12515	West	MUKATSAR	11KV	DS DIVN. ABOHAR	DS S/D NO. 2 ABOHAR	CS06F12	11 KV ABC	AMR	OK	31.03.2023	Category 1				9568165	1200-600/5	4.822	NA	Director/D	
B.12516	West	MUKATSAR	11KV	DS DIVN. ABOHAR	DS S/D NO. 2 ABOHAR	CS06F09	11 KV LINK NO. 2	NON AMR	OK	31.03.2023	Category 1				9568140	1200-600/5	10.069	NA	Director/D	
B.12517	West	MUKATSAR	11KV	DS DIVN. ABOHAR	DS S/D NO. 2 ABOHAR	ES21F09	11 KV TARA ESTATE	AMR	OK	31.03.2023	Category 1				37020	900-450/5	1.328	NA	Director/D	
B.12518	West	MUKATSAR	11KV	DS DIVN. ABOHAR	DS S/D NO. 2 ABOHAR	ES21F01	11 KV GANGA NAGAR ROAD	AMR	OK	31.03.2023	Category 1				9141036	900-450/5	2.396	NA	Director/D	
B.12519	West	MUKATSAR	11KV	DS DIVN. ABOHAR	DS S/D NO. 2 ABOHAR	ES21F06	11 KV NW ABOHAR	AMR	OK	31.03.2023	Category 1				9568387	900-450/5	8.962	NA	Director/D	
B.12520	West	MUKATSAR	11KV	DS DIVN. ABOHAR	DS S/D NO. 2 ABOHAR	ES21F03	11 KV SIKHI NAGRI	NON AMR	OK	31.03.2023	Category 1				9568387	900-450/5	9.961	NA	Director/D	
B.12521	West	MUKATSAR	11KV	DS DIVN. ABOHAR	DS S/D NO. 2 ABOHAR	NA03F04	11 KV Chakra AP	NON AMR	OK	31.03.2023	AP 3Phase 3WIr				3261	1200/577/1-1-1	1.684	NA	Director/D	
B.12522	West	MUKATSAR	11KV	DS DIVN. ABOHAR	DS S/D NO. 2 ABOHAR	NA03F03	11 KV Aisngarh Urban	NON AMR	OK	31.03.2023	Category 1				3251	1200/577/1-1-1	4.073	NA	Director/D	
B.12523	West	MUKATSAR	11KV	DS DIVN. ABOHAR	DS S/D NO. 2 ABOHAR	NA03F02	11 KV Dhani Bishesamath	NON AMR	OK	31.03.2023	Category 1				3255	1200/577/1-1-1	4.911	NA	Director/D	
B.12524	West	MUKATSAR	11KV	DS DIVN. ABOHAR	DS S/D NO. 2 ABOHAR	NA03F01	11 KV South Avenue	NON AMR	OK	31.03.2023	Category 1				2958	1200/577/1-1-1	11.649	NA	Director/D	
B.12525	West	MUKATSAR	11KV	DS DIVN. ABOHAR	DS S/D NO. 2 ABOHAR	TFN1F01	11 KV Jodhpur	NON AMR	OK	31.03.2023	AP 3Phase 3WIr				34093	400-200/5-5	1.630	NA	Director/D	
B.12526	West	MUKATSAR	11KV	DS DIVN. ABOHAR	DS S/D NO. 2 ABOHAR	TFN1F03	11 KV Kera Khera	NON AMR	OK	31.03.2023	AP 3Phase 3WIr				36765	400-200/5-5	2.129	NA	Director/D	
B.12527	West	MUKATSAR	11KV	DS DIVN. ABOHAR	DS S/D NO. 2 ABOHAR	TFN1F02	11 KV Malookpura UPS	NON AMR	OK	31.03.2023	Category 5-UPS				34215	400-200/5-5	3.364	NA	Director/D	
B.12528	West	MUKATSAR	11KV	DS DIVN. ABOHAR	DS S/D NO. 2 ABOHAR	TFN1F04	11 KV Dhaban Kokian	AMR	OK	31.03.2023	Category 5-UPS				36691	400-200/5-5	9.145	NA	Director/D	
B.12529	West	MUKATSAR	11KV	DS DIVN. ABOHAR	DS S/D NO. 2 ABOHAR	ES29F05	11 KB BAZIDOPURA	AMR	OK	31.03.2023	AP 3Phase 3WIr				8223425	900-450/5	0.803	NA	Director/D	
B.12530	West	MUKATSAR	11KV	DS DIVN. ABOHAR	DS S/D NO. 2 ABOHAR	ES29F02	11 KV BUREHWAN	AMR	OK	31.03.2023	AP 3Phase 3WIr				727196	900-450/5	0.622	NA	Director/D	
B.12531	West	MUKATSAR	11KV	DS DIVN. ABOHAR	DS S/D NO. 2 ABOHAR	ES29F06	11 KV SARDARPURA UPS	AMR	OK	31.03.2023	Category 5-UPS				2825	900-450/5	9.352	NA	Director/D	
B.12532	West	MUKATSAR	11KV	DS DIVN. ABOHAR	DS S/D NO. 2 ABOHAR	ES29F03	11 KV SITO	AMR	OK	31.03.2023	Category 3-UPS				10282946	900-450/5	10.860	NA	Director/D	
B.12533	West	MUKATSAR	11KV	DS DIVN. ABOHAR	DS S/D NO. 3 ABOHAR	CS06F03	11 KV GOBIND GARH	AMR	OK	31.03.2023	AP 3Phase 3WIr				9568191	1200-600/5	2.032	NA	Director/D	
B.12534	West	MUKATSAR	11KV	DS DIVN. ABOHAR	DS S/D NO. 3 ABOHAR	CS06F15	11 KV Bural Muhar	AMR	OK	31.03.2023	AP 3Phase 3WIr				1955068	1200-600/5	2.470	NA	Director/D	
B.12535	West	MUKATSAR	11KV	DS DIVN. ABOHAR	DS S/D NO. 3 ABOHAR	CS06F02	11 KV BALLUANA	AMR	OK	31.03.2023	AP 3Phase 3WIr				9568152	1200-600/5	2.709	NA	Director/D	
B.12536	West	MUKATSAR	11KV	DS DIVN. ABOHAR	DS S/D NO. 3 ABOHAR	CS06F17	11 KV MALHOTRA ROAD	AMR	OK	31.03.2023	Category 1				9568233	1200-600/5	3.362	NA	Director/D	
B.12537	West	MUKATSAR	11KV	DS DIVN. ABOHAR	DS S/D NO. 3 ABOHAR	CS06F04	BAHAWAL BASI	NON AMR	OK	31.03.2023	Category 5-UPS				9568141	1200-600/5	11.828	NA	Director/D	
B.12538	West	MUKATSAR	11KV	DS DIVN. ABOHAR	DS S/D NO. 3 ABOHAR	ES21F08	11 KV KIKKER KHERA	NON AMR	OK	31.03.2023	AP 3Phase 3WIr				34008	900-450/5	0.741	NA	Director/D	
B.12539	West	MUKATSAR	11KV	DS DIVN. ABOHAR	DS S/D NO. 3 ABOHAR	ES21011	BSF	AMR	OK	31.03.2023	Category 2				2853	900-450/5	0.849	NA	Director/D	
B.12540	West	MUKATSAR	11KV	DS DIVN. ABOHAR	DS S/D NO. 3 ABOHAR	ES21F06	11 KV KILLIANWALI	NON AMR	OK	31.03.2023	AP 3Phase 3WIr				9153999	900-450/5	1.500	NA	Director/D	
B.12541	West	MUKATSAR	11KV	DS DIVN. ABOHAR	DS S/D NO. 3 ABOHAR	ES21F13	11 KV BIRDI SIDHI URBAN	AMR	OK	31.03.2023	Category 1				4714	900-450/5	8.978	NA	Director/D	
B.12542	West	MUKATSAR	11KV	DS DIVN. ABOHAR	DS S/D NO. 3 ABOHAR	ES21F03	11 KV Alamgarh	AMR	OK	31.03.2023	Category 5-UPS				8223496	900-450/5	11.369	NA	Director/D	
B.12543	West	MUKATSAR	11KV	DS DIVN. ABOHAR	DS S/D NO. 3 ABOHAR	ES21F10	11 KV KANDHWALA Road Urban	AMR	OK	31.03.2023	Category 1				34190	900-450/5	12.263	NA	Director/D	
B.12544	West	MUKATSAR	11KV	DS DIVN. ABOHAR	DS S/D NO. 3 ABOHAR	ES23F02	11 KV KULAR	AMR	OK	31.03.2023	AP 3Phase 3WIr				6679927	1200-600/5	0.346	NA	Director/D	
B.12545	West	MUKATSAR	11KV	DS DIVN. ABOHAR	DS S/D NO. 3 ABOHAR	ES23F04	11 KV BAHAV WALA	NON AMR	OK	31.03.2023	Category 1				3175015	1200-600/5	2.968	NA	Director/D	
B.12546	West	MUKATSAR	11KV	DS DIVN. ABOHAR	DS S/D NO. 3 ABOHAR	ES29F06	11 KV KANDHWALA UPS	AMR	OK	31.03.2023	Category 5-UPS				52					

S.No	Zone	Circle	Voltage Level (kVA)	Division (kVA)	Sub-Division (kVA)	Feeder ID	Feeder Name	Feeder Metering Status (Meters/Numbered/AM/AMR)	Status of Meter (Functional/Non-Functional)	Metering Date (Date of last actual meter reading/communication)	Feeder Type (Agr/Industrial/Mixed)	Status of Communication			Period from 01.04.2021 to 31.03.2022				Sales	Remarks (Source of data)
												% data received through automatically by feeder AMR/AM	Number of hours when meter was unable to communicate in overall	Total Number of hours in the period	Meter S.No	CT/PT ratio	Import (kWh)	Export (kWh)		
B.12580	West	MUKATSAR	11KV	DS DIVN. BADAL	DS S/D BADAL	D517FL01	Nandgarh Ghudda	AMR	OK	31.03.2023	Category 1								NA	Director/D
B.12581	West	MUKATSAR	11KV	DS DIVN. BADAL	DS S/D BADAL	D517FL02	Nandgarh-2	AMR	OK	31.03.2023	AP 3Phase 3Wire								NA	Director/D
B.12582	West	MUKATSAR	11KV	DS DIVN. BADAL	DS S/D BADAL	D517FL11	GHUDDA	AMR	OK	31.03.2023	Category 5-UPS								NA	Director/D
B.12583	West	MUKATSAR	11KV	DS DIVN. BADAL	DS S/D BADAL	D517FL06	Bajak	Not available	OK	31.03.2023	Category 5-UPS								NA	Director/D
B.12584	West	MUKATSAR	66KV	DS DIVN. BADAL	DS S/D BADAL	D517N6W	66 KV Ghudda University	AMR	OK	31.03.2023	Category 4								NA	Director/D
B.12585	West	MUKATSAR	11KV	DS DIVN. BADAL	DS S/D DABWALI	D518FL10	11 KV Bhullarwala	AMR	OK	31.03.2023	AP 3Phase 4Wire								NA	Director/D
B.12586	West	MUKATSAR	11KV	DS DIVN. BADAL	DS S/D DABWALI	D518FL01	Bhullarwala	AMR	OK	31.03.2023	Category 5-UPS								NA	Director/D
B.12587	West	MUKATSAR	11KV	DS DIVN. BADAL	DS S/D DABWALI	FL11D516	Bhatti Colony	AMR	OK	31.03.2023	Category 1								NA	Director/D
B.12588	West	MUKATSAR	11KV	DS DIVN. BADAL	DS S/D DABWALI	D515FL03	Lohara	AMR	OK	31.03.2023	AP 3Phase 3Wire								NA	Director/D
B.12589	West	MUKATSAR	11KV	DS DIVN. BADAL	DS S/D DABWALI	D515FL08	Killianwall	AMR	OK	31.03.2023	AP 3Phase 3Wire								NA	Director/D
B.12590	West	MUKATSAR	11KV	DS DIVN. BADAL	DS S/D DABWALI	D515FL01	Doomwall AP	AMR	OK	31.03.2023	AP 3Phase 3Wire								NA	Director/D
B.12591	West	MUKATSAR	11KV	DS DIVN. BADAL	DS S/D DABWALI	D515FL10	KILLIANWALI	AMR	OK	31.03.2023	Category 5-UPS								NA	Director/D
B.12592	West	MUKATSAR	11KV	DS DIVN. BADAL	DS S/D DABWALI	D515FL05	Independent	AMR	OK	31.03.2023	Category 4								NA	Director/D
B.12593	West	MUKATSAR	11KV	DS DIVN. BADAL	DS S/D DABWALI	D515FL06	Nar Singh Colony	AMR	OK	31.03.2023	Category 5-UPS								NA	Director/D
B.12594	West	MUKATSAR	11KV	DS DIVN. BADAL	DS S/D DABWALI	D515FL04	City Urban	AMR	OK	31.03.2023	Category 1								NA	Director/D
B.12595	West	MUKATSAR	11KV	DS DIVN. BADAL	DS S/D DABWALI	D518FL09	Station Side	AMR	OK	31.03.2023	AP 3Phase 3Wire								NA	Director/D
B.12596	West	MUKATSAR	11KV	DS DIVN. BADAL	DS S/D DABWALI	D518FL08	Dhani Mangrept	AMR	OK	31.03.2023	AP 3Phase 3Wire								NA	Director/D
B.12597	West	MUKATSAR	11KV	DS DIVN. BADAL	DS S/D DABWALI	D518FL04	Mididhara AP	AMR	OK	31.03.2023	AP 3Phase 3Wire								NA	Director/D
B.12598	West	MUKATSAR	11KV	DS DIVN. BADAL	DS S/D DABWALI	D518FL16	BRING KHERA AP	AMR	OK	31.03.2023	AP 3Phase 3Wire								NA	Director/D
B.12599	West	MUKATSAR	11KV	DS DIVN. BADAL	DS S/D DABWALI	D518FL07	Ghumara	AMR	OK	31.03.2023	Category 1								NA	Director/D
B.12600	West	MUKATSAR	11KV	DS DIVN. BADAL	DS S/D DABWALI	D518FL03	Mididhara Urban	AMR	OK	31.03.2023	Category 1								NA	Director/D
B.12601	West	MUKATSAR	11KV	DS DIVN. BADAL	DS S/D DABWALI	D518FL01	Fatakera Urban	AMR	OK	31.03.2023	Category 1								NA	Director/D
B.12602	West	MUKATSAR	11KV	DS DIVN. BADAL	DS S/D DABWALI	E516FL01	BRING KHERA	AMR	OK	31.03.2023	Category 5-UPS								NA	Director/D
B.12603	West	MUKATSAR	11KV	DS DIVN. BADAL	DS S/D DABWALI	E516FL05	GHUMARA	AMR	OK	31.03.2023	Category 5-UPS								NA	Director/D
B.12604	West	MUKATSAR	11KV	DS DIVN. BADAL	DS S/D DABWALI	D513FL02	Kuti	AMR	OK	31.03.2023	AP 3Phase 3Wire								NA	Director/D
B.12605	West	MUKATSAR	11KV	DS DIVN. BADAL	DS S/D DABWALI	D513FL07	FALLAR AP	AMR	OK	31.03.2023	AP 3Phase 3Wire								NA	Director/D
B.12606	West	MUKATSAR	11KV	DS DIVN. BADAL	DS S/D DABWALI	D513FL04	DHANI -PATHRALA	AMR	OK	31.03.2023	AP 3Phase 3Wire								NA	Director/D
B.12607	West	MUKATSAR	11KV	DS DIVN. BADAL	DS S/D DABWALI	D513FL03	RULDU SINGH WALA	AMR	OK	31.03.2023	Category 5-UPS								NA	Director/D
B.12608	West	MUKATSAR	11KV	DS DIVN. BADAL	DS S/D DABWALI	D513FL01	asthrala Urban	AMR	OK	31.03.2023	Category 1								NA	Director/D
B.12609	West	MUKATSAR	11KV	DS DIVN. BADAL	DS S/D LAMBI	D523FL02	Banwala Rural	AMR	OK	31.03.2023	AP 3Phase 3Wire								NA	Director/D
B.12610	West	MUKATSAR	11KV	DS DIVN. BADAL	DS S/D LAMBI	D523FL03	Rakhnawal	AMR	OK	31.03.2023	AP 3Phase 3Wire								NA	Director/D
B.12611	West	MUKATSAR	11KV	DS DIVN. BADAL	DS S/D LAMBI	D523N6EW	BRAGLI	AMR	OK	31.03.2023	AP 3Phase 3Wire								NA	Director/D
B.12612	West	MUKATSAR	11KV	DS DIVN. BADAL	DS S/D LAMBI	D523FL04	MEHNA	AMR	OK	31.03.2023	AP 3Phase 3Wire								NA	Director/D
B.12613	West	MUKATSAR	11KV	DS DIVN. BADAL	DS S/D LAMBI	D523FL07	DHANI CHAK MIDDU SINGH WALA	AMR	OK	31.03.2023	AP 3Phase 3Wire								NA	Director/D
B.12614	West	MUKATSAR	11KV	DS DIVN. BADAL	DS S/D LAMBI	D523FL01	Banwala Urban	AMR	OK	31.03.2023	Category 1								NA	Director/D
B.12615	West	MUKATSAR	11KV	DS DIVN. BADAL	DS S/D LAMBI	D523FL05	Mejna	AMR	OK	31.03.2023	Category 5-UPS								NA	Director/D
B.12616	West	MUKATSAR	11KV	DS DIVN. BADAL	DS S/D LAMBI	D518FL01	Roanwall	AMR	OK	31.03.2023	AP 3Phase 3Wire								NA	Director/D
B.12617	West	MUKATSAR	11KV	DS DIVN. BADAL	DS S/D LAMBI	D518FL11	HARMEET RURAL	AMR	OK	31.03.2023	AP 3Phase 3Wire								NA	Director/D
B.12618	West	MUKATSAR	11KV	DS DIVN. BADAL	DS S/D LAMBI	D518FL05	Tarmala Dhani / Kandukhera	AMR	OK	31.03.2023	AP 3Phase 3Wire								NA	Director/D
B.12619	West	MUKATSAR	11KV	DS DIVN. BADAL	DS S/D LAMBI	D518FL07	Tarsem Brach (AP)	AMR	OK	31.03.2023	AP 3Phase 3Wire								NA	Director/D
B.12620	West	MUKATSAR	11KV	DS DIVN. BADAL	DS S/D LAMBI	D518FL02	Kandukhera	AMR	OK	31.03.2023	Category 5-UPS								NA	Director/D
B.12621	West	MUKATSAR	11KV	DS DIVN. BADAL	DS S/D LAMBI	D518FL06	Bhetwala Urban	AMR	OK	31.03.2023	Category 1								NA	Director/D
B.12622	West	MUKATSAR	11KV	DS DIVN. BADAL	DS S/D LAMBI	D518FL04	Kati	AMR	OK	31.03.2023	Category 5-UPS								NA	Director/D
B.12623	West	MUKATSAR	11KV	DS DIVN. BADAL	DS S/D LAMBI	D519FL09	Civil Hospital Lambi	AMR	OK	31.03.2023	Category 4								NA	Director/D
B.12624	West	MUKATSAR	11KV	DS DIVN. BADAL	DS S/D LAMBI	D519FL08	Seknahera	AMR	OK	31.03.2023	AP 3Phase 3Wire								NA	Director/D
B.12625	West	MUKATSAR	11KV	DS DIVN. BADAL	DS S/D LAMBI	D519FL03	Nanakar	AMR	OK	31.03.2023	AP 3Phase 3Wire								NA	Director/D
B.12626	West	MUKATSAR	11KV	DS DIVN. BADAL	DS S/D LAMBI	D519FL11	BABA MAAN SINGH	AMR	OK	31.03.2023	AP 3Phase 3Wire								NA	Director/D
B.12627	West	MUKATSAR	11KV	DS DIVN. BADAL	DS S/D LAMBI	D519FL10	Kuldeep	AMR	OK	31.03.2023	AP 3Phase 3Wire								NA	Director/D
B.12628	West	MUKATSAR	11KV	DS DIVN. BADAL	DS S/D LAMBI	D519FL05	Poojawa	AMR	OK	31.03.2023	AP 3Phase 3Wire								NA	Director/D
B.12629	West	MUKATSAR	11KV	DS DIVN. BADAL	DS S/D LAMBI	D519FL01	Channu	AMR	OK	31.03.2023	AP 3Phase 3Wire								NA	Director/D
B.12630	West	MUKATSAR	11KV	DS DIVN. BADAL	DS S/D LAMBI	D519FL02	Lambi	AMR	OK	31.03.2023	Category 5-UPS								NA	Director/D
B.12631	West	MUKATSAR	11KV	DS DIVN. BADAL	DS S/D LAMBI	D519FL04	Khuddian	AMR	OK	31.03.2023	Category 5-UPS								NA	Director/D
B.12632	West	MUKATSAR	11KV	DS DIVN. BADAL	DS S/D LAMBI	D519FL07	Khowall	AMR	OK	31.03.2023	Category 5-UPS								NA	Director/D
B.12633	West	MUKATSAR	11KV	DS DIVN. BADAL	DS S/D LAMBI	D519FL06	Bidwala	AMR	OK	31.03.2023	Category 1								NA	Director/D
B.12634	West	MUKATSAR	11KV	DS DIVN. BADAL	DS S/D LAMBI	D524FL04	Adhinya New	AMR	OK	31.03.2023	AP 3Phase 3Wire								NA	Director/D
B.12635	West	MUKATSAR	11KV	DS DIVN. BADAL	DS S/D LAMBI	D524FL02	Rural Sikhwala	AMR	OK	31.03.2023	AP 3Phase 3Wire								NA	Director/D
B.12636	West	MUKATSAR	11KV	DS DIVN. BADAL	DS S/D LAMBI	D524FL05	Fatuhikhera - 66 KV Sikhwala	AMR	OK	31.03.2023	AP 3Phase 3Wire								NA	Director/D
B.12637	West	MUKATSAR	11KV	DS DIVN. BADAL	DS S/D LAMBI	D524FL01	Sikhwala Urban	AMR	OK	31.03.2023	Category 1								NA	Director/D
B.12638	West	MUKATSAR	11KV	DS DIVN. BADAL	DS S/D LAMBI	D524FL03	Fatuhikhera	AMR	OK	31.03.2023	Category 5-UPS								NA	Director/D
B.12639	West	MUKATSAR	66KV	DS DIVN. BADAL	DS S/D LAMBI	D519N6W	SEI PUNJAWA	Not available	OK	31.03.2023	Category 4								NA	Director/D
B.12640	West	MUKATSAR	11KV	DS DIVN. FAZILKA	DS CITY S/D FAZILKA	D505FL14	Madhav Nagri	NON AMR	OK	31.03.2023	Category 1								NA	Director/D
B.12641	West	MUKATSAR	11KV	DS DIVN. FAZILKA	DS CITY S/D FAZILKA	D505FL18	Civil Hospital	NON AMR	OK	31.03.2023	Category 2								NA	Director/D
B.12642	West	MUKATSAR	11KV	DS DIVN. FAZILKA	DS CITY S/D FAZILKA	D505FL19	M. R. Enclave	AMR	OK	31.03.2023	Category 1								NA	Director/D
B.12643	West	MUKATSAR	11KV	DS DIVN. FAZILKA	DS CITY S/D FAZILKA	D505FL14	Ferozpur Road	AMR	OK	31.03.2023	Category 1								NA	Director/D
B.12644	West	MUKATSAR	11KV	DS DIVN. FAZILKA	DS CITY S/D FAZILKA	D505FL06	Tarwala	AMR	OK	31.03.2023	Category 1								NA	Director/D
B.12645	West	MUKATSAR	11KV	DS DIVN. FAZILKA	DS CITY S/D FAZILKA	D505FL11	Gaushala	AMR												

S.No	Zone	Circle	Voltage Level (kVA)	Division (kVA)	Sub-Division (kVA)	Feeder ID	Feeder Name	Feeder Metering Status (Metered/unmetered/AM/AMR)	Status of Meter (Functional/Non-Functional)	Metering Date (Date of last actual meter reading/communication)	Feeder Type (Agr/Industrial/Mixed)	Status of Communication			Period from 01.04.2021 to 31.03.2022				Sales	Remarks (Source of data)
												% data received through automatically by feeder AMR/AMI	Number of hours when meter was unable to communicate in overall	Total Number of hours in the period	Meter S.No	CT/PT ratio	Import (kWh)	Export (kWh)		
B.12677	West	MUKATSAR	11KV	DS DIVN. FAZILKA	DS S/D KHUI KHERA	E528F103	KHUIKHERA UPS	AMR	OK	31.03.2023	Category 5-UPS				11117200	900-450/5	3.519	NA	Director/D	
B.12678	West	MUKATSAR	11KV	DS DIVN. FAZILKA	DS S/D KHUI KHERA	E543F110	KABULSHAH KHUBAN UPS	AMR	OK	31.03.2023	Category 5-UPS				8223324	900-450/5	7.756	NA	Director/D	
B.12679	West	MUKATSAR	11KV	DS DIVN. FAZILKA	DS S/D KHUI KHERA	E528F107	NHAL KHERA UPS	AMR	OK	31.03.2023	Category 5-UPS				5295382	1200-600/5	8.316	NA	Director/D	
B.12680	West	MUKATSAR	11KV	DS DIVN. FAZILKA	DS S/D KHUI KHERA	E528F104	BOP WALA UPS	NON AMR	OK	31.03.2023	Category 5-UPS				2046686	1200-600/5	8.939	NA	Director/D	
B.12681	West	MUKATSAR	11KV	DS DIVN. FAZILKA	DS S/D KHUI KHERA	E527F111	Shair wala	AMR	OK	31.03.2023	AP 3Phase 3Wire				4586	1200-600/5	1.052	NA	Director/D	
B.12682	West	MUKATSAR	11KV	DS DIVN. FAZILKA	DS S/D KHUI KHERA	E527F109	Lathe Wall Dhab	AMR	OK	31.03.2023	AP 3Phase 3Wire				16194353	1200-600/5	1.236	NA	Director/D	
B.12683	West	MUKATSAR	11KV	DS DIVN. FAZILKA	DS S/D KHUI KHERA	E527F102	SIWANA AP	AMR	OK	31.03.2023	AP 3Phase 3Wire				777432	1200-600/5	1.895	NA	Director/D	
B.12684	West	MUKATSAR	11KV	DS DIVN. FAZILKA	DS S/D KHUI KHERA	E527F105	TILIAM WALI AP	AMR	OK	31.03.2023	AP 3Phase 3Wire				9534400	1200-600/5	2.011	NA	Director/D	
B.12685	West	MUKATSAR	11KV	DS DIVN. FAZILKA	DS S/D KHUI KHERA	E527F107	KHEO WALI DHAB URBAN	AMR	OK	31.03.2023	Category 5-UPS				6027234	1200-600/5	2.711	NA	Director/D	
B.12686	West	MUKATSAR	11KV	DS DIVN. FAZILKA	DS S/D KHUI KHERA	E537F101	BANDI WALA UPS	AMR	OK	31.03.2023	Category 5-UPS				15872	1200-600/5	6.451	NA	Director/D	
B.12687	West	MUKATSAR	11KV	DS DIVN. FAZILKA	DS S/D LADUKA	0545F103	THUL BURI	AMR	OK	31.03.2023	AP 3Phase 3Wire				11117049	900-450/5	1.426	NA	Director/D	
B.12688	West	MUKATSAR	11KV	DS DIVN. FAZILKA	DS S/D LADUKA	0545F102	Theh Galander	AMR	OK	31.03.2023	Category 5-UPS				11116914	900-450/5	1.623	NA	Director/D	
B.12689	West	MUKATSAR	11KV	DS DIVN. FAZILKA	DS S/D LADUKA	0545F101	Shama Khan Ka	NON AMR	OK	31.03.2023	AP 3Phase 3Wire				11117224	900-450/5	1.699	NA	Director/D	
B.12690	West	MUKATSAR	11KV	DS DIVN. FAZILKA	DS S/D LADUKA	0545F104	THEH GALANDER	NON AMR	OK	31.03.2023	AP 3Phase 3Wire				54456151	900-450/5	1.768	NA	Director/D	
B.12691	West	MUKATSAR	11KV	DS DIVN. FAZILKA	DS S/D LADUKA	0545F105	Chandmani	NON AMR	OK	31.03.2023	AP 3Phase 3Wire				4036	900-450/5	1.819	NA	Director/D	
B.12692	West	MUKATSAR	11KV	DS DIVN. FAZILKA	DS S/D LADUKA	0545F106	Dhani bulla ram	NON AMR	OK	31.03.2023	Category 5-UPS				35200	900-450/5	3.494	NA	Director/D	
B.12693	West	MUKATSAR	11KV	DS DIVN. FAZILKA	DS S/D LADUKA	0467F110	Chak Budho Ke	NON AMR	OK	31.03.2023	AP 3Phase 3Wire				23702	900-450/5	1.382	NA	Director/D	
B.12694	West	MUKATSAR	11KV	DS DIVN. FAZILKA	DS S/D LADUKA	0467F112	CHHAPRI WALA	AMR	OK	31.03.2023	AP 3Phase 3Wire				35165	900-450/5	1.459	NA	Director/D	
B.12695	West	MUKATSAR	11KV	DS DIVN. FAZILKA	DS S/D LADUKA	0467F107	Rangela	AMR	OK	31.03.2023	AP 3Phase 3Wire				9154159	900-450/5	1.859	NA	Director/D	
B.12696	West	MUKATSAR	11KV	DS DIVN. FAZILKA	DS S/D LADUKA	0467F101	Budho ke	AMR	OK	31.03.2023	AP 3Phase 3Wire				7030197	900-450/5	2.093	NA	Director/D	
B.12697	West	MUKATSAR	11KV	DS DIVN. FAZILKA	DS S/D LADUKA	0507F109	SAHI WALA	AMR	OK	31.03.2023	AP 3Phase 3Wire				36672	900-450/5/7/1-1	1.095	NA	Director/D	
B.12698	West	MUKATSAR	11KV	DS DIVN. FAZILKA	DS S/D LADUKA	0507F108	Chimme Wala urban Cat 1	AMR	OK	31.03.2023	Category 1				4187948	900-450/5/7/1-1	1.143	NA	Director/D	
B.12699	West	MUKATSAR	11KV	DS DIVN. FAZILKA	DS S/D LADUKA	0507F103	Ohan Wali	AMR	OK	31.03.2023	AP 3Phase 3Wire				5342136	900-450/5/7/1-1	1.201	NA	Director/D	
B.12700	West	MUKATSAR	11KV	DS DIVN. FAZILKA	DS S/D LADUKA	0507F101	Chimme Wala	NON AMR	OK	31.03.2023	AP 3Phase 3Wire				5343262	900-450/5/7/1-1	1.584	NA	Director/D	
B.12701	West	MUKATSAR	11KV	DS DIVN. FAZILKA	DS S/D LADUKA	0507F112	Bahe Wala	NON AMR	OK	31.03.2023	AP 3Phase 3Wire				4653	900-450/5/7/1-1	1.684	NA	Director/D	
B.12702	West	MUKATSAR	11KV	DS DIVN. FAZILKA	DS S/D LADUKA	0507F111	Jato Wali	NON AMR	OK	31.03.2023	AP 3Phase 3Wire				45676	900-450/5/7/1-1	1.785	NA	Director/D	
B.12703	West	MUKATSAR	11KV	DS DIVN. FAZILKA	DS S/D LADUKA	0507F102	Chak Pakhi	AMR	OK	31.03.2023	AP 3Phase 3Wire				23753	900-450/5/7/1-1	2.094	NA	Director/D	
B.12704	West	MUKATSAR	11KV	DS DIVN. FAZILKA	DS S/D LADUKA	0507F107	Hauz Khaz	NON AMR	OK	31.03.2023	Category 5-UPS				5437694	900-450/5/7/1-1	4.588	NA	Director/D	
B.12705	West	MUKATSAR	11KV	DS DIVN. FAZILKA	DS S/D LADUKA	0507F110	Zorki Andhe Wali	AMR	OK	31.03.2023	Category 5-UPS				2067166	900-450/5/7/1-1	5.392	NA	Director/D	
B.12706	West	MUKATSAR	11KV	DS DIVN. FAZILKA	DS S/D LADUKA	0507F113	KHEOWALA UPS	AMR	OK	31.03.2023	Category 5-UPS				8222667	900-450/5/7/1-1	8.765	NA	Director/D	
B.12707	West	MUKATSAR	11KV	DS DIVN. FAZILKA	DS S/D LADUKA	0508F111	Jamal ke	NON AMR	OK	31.03.2023	AP 3Phase 3Wire				11117893	1200-600/5	0.954	NA	Director/D	
B.12708	West	MUKATSAR	11KV	DS DIVN. FAZILKA	DS S/D LADUKA	0508F104	Jato Wali	NON AMR	OK	31.03.2023	AP 3Phase 3Wire				4223117	1200-600/5	1.397	NA	Director/D	
B.12709	West	MUKATSAR	11KV	DS DIVN. FAZILKA	DS S/D LADUKA	0508F119	Achharki	AMR	OK	31.03.2023	AP 3Phase 3Wire				5259	900-450/5/7/1-1	1.656	NA	Director/D	
B.12710	West	MUKATSAR	11KV	DS DIVN. FAZILKA	DS S/D LADUKA	0508F115	GULAM RASOOL	AMR	OK	31.03.2023	AP 3Phase 3Wire				36713	900-450/5/7/1-1	1.965	NA	Director/D	
B.12711	West	MUKATSAR	11KV	DS DIVN. FAZILKA	DS S/D LADUKA	0508F101	Ahal Bodla	AMR	OK	31.03.2023	AP 3Phase 3Wire				23462	1200-600/5	2.007	NA	Director/D	
B.12712	West	MUKATSAR	11KV	DS DIVN. FAZILKA	DS S/D LADUKA	0508F105	Behak Khaz	NON AMR	OK	31.03.2023	AP 3Phase 3Wire				11116946	1200-600/5	2.267	NA	Director/D	
B.12713	West	MUKATSAR	11KV	DS DIVN. FAZILKA	DS S/D LADUKA	0508F116	Bhaji Bhatan Singh	AMR	OK	31.03.2023	AP 3Phase 3Wire				33260	900-450/5/7/1-1	2.126	NA	Director/D	
B.12714	West	MUKATSAR	11KV	DS DIVN. FAZILKA	DS S/D LADUKA	0508F106	Ghubawi	AMR	OK	31.03.2023	AP 3Phase 3Wire				23238	1200-600/5	2.352	NA	Director/D	
B.12715	West	MUKATSAR	11KV	DS DIVN. FAZILKA	DS S/D LADUKA	0508F110	Ghurka	NON AMR	OK	31.03.2023	AP 3Phase 3Wire				11116741	1200-600/5	2.404	NA	Director/D	
B.12716	West	MUKATSAR	11KV	DS DIVN. FAZILKA	DS S/D LADUKA	0508F114	GUDDAR BHANI	AMR	OK	31.03.2023	AP 3Phase 3Wire				3618	900-450/5/7/1-1	2.821	NA	Director/D	
B.12717	West	MUKATSAR	11KV	DS DIVN. FAZILKA	DS S/D LADUKA	0508F103	Tarabri	AMR	OK	31.03.2023	AP 3Phase 3Wire				11114503	1200-600/5	4.348	NA	Director/D	
B.12718	West	MUKATSAR	11KV	DS DIVN. FAZILKA	DS S/D LADUKA	0508F109	Palhuwa	AMR	OK	31.03.2023	Category 1				11117229	1200-600/5	4.380	NA	Director/D	
B.12719	West	MUKATSAR	11KV	DS DIVN. FAZILKA	DS S/D LADUKA	0508F113	Wari Jamand	AMR	OK	31.03.2023	AP 3Phase 3Wire				9150499	1200-600/5	4.403	NA	Director/D	
B.12720	West	MUKATSAR	11KV	DS DIVN. FAZILKA	DS S/D LADUKA	0508F112	Fatehgarh	NON AMR	OK	31.03.2023	Category 5-UPS				5343289	1200-600/5	5.775	NA	Director/D	
B.12721	West	MUKATSAR	11KV	DS DIVN. FAZILKA	DS S/D LADUKA	0508F118	Lathe ke uttar	NON AMR	OK	31.03.2023	Category 5-UPS				4975	900-450/5/7/1-1	8.326	NA	Director/D	
B.12722	West	MUKATSAR	11KV	DS DIVN. FAZILKA	DS S/D LADUKA	0508F117	Railway road ladhuka mandi	AMR	OK	31.03.2023	Category 1				33980	1200-600/5	10.433	NA	Director/D	
B.12723	West	MUKATSAR	11KV	DS DIVN. FAZILKA	DS S/D LADUKA	0543F103	Hastia Kalan	AMR	OK	31.03.2023	AP 3Phase 3Wire				777107	900-450/5	1.602	NA	Director/D	
B.12724	West	MUKATSAR	11KV	DS DIVN. FAZILKA	DS S/D LADUKA	0508F104	Chah	AMR	OK	31.03.2023	AP 3Phase 3Wire				8222998	900-450/5/7/1-1	4.961	NA	Director/D	
B.12725	West	MUKATSAR	11KV	DS DIVN. FAZILKA	DS S/D LADUKA	0508F103	Saido ke	AMR	OK	31.03.2023	AP 3Phase 3Wire				8222986	900-450/5/7/1-1	1.840	NA	Director/D	
B.12726	West	MUKATSAR	11KV	DS DIVN. FAZILKA	DS S/D LADUKA	0506F108	Rana UPS No. 1	AMR	OK	31.03.2023	Category 5-UPS				5260	900-450/5/7/1-1	7.664	NA	Director/D	
B.12727	West	MUKATSAR	11KV	DS DIVN. FAZILKA	DS S/U S/D FAZILKA	0512F105	Chuwaria Wali	AMR	OK	31.03.2023	AP 3Phase 3Wire				7042841	900-450/5	1.339	NA	Director/D	
B.12728	West	MUKATSAR	11KV	DS DIVN. FAZILKA	DS S/U S/D FAZILKA	0512F108	Abhun	AMR	OK	31.03.2023	AP 3Phase 3Wire				4368	900-450/5	1.914	NA	Director/D	
B.12729	West	MUKATSAR	11KV	DS DIVN. FAZILKA	DS S/U S/D FAZILKA	0512F111	UPS Koran Wali	NON AMR	OK	31.03.2023	Category 1				4300	900-450/5	6.354	NA	Director/D	
B.12730	West	MUKATSAR	11KV	DS DIVN. FAZILKA	DS S/U S/D FAZILKA	0507F106	Chak OMBWALA	AMR	OK	31.03.2023	AP 3Phase 3Wire				46153	900-450/5/7/1-1	1.349	NA	Director/D	
B.12731	West	MUKATSAR	11KV	DS DIVN. FAZILKA	DS S/U S/D FAZILKA	0507F105	Chak Banwala	AMR	OK	31.03.2023	AP 3Phase 3Wire				23266	900-450/5/7/1-1	1.427	NA	Director/D	
B.12732	West	MUKATSAR	11KV	DS DIVN. FAZILKA	DS S/U S/D FAZILKA	0505F120	SampurAgrventure	AMR	OK	31.03.2023	Category 2				13517602	1200-600/5	0.281	NA	Director/D	
B.12733	West	MUKATSAR	11KV	DS DIVN. FAZILKA	DS S/U S/D FAZILKA	0505F121	RAMNAGAR	NON AMR	OK	31.03.2023	AP 3Phase 3Wire				15196594	1200-600/5	1.300	NA	Director/D	
B.12734	West	MUKATSAR	11KV	DS DIVN. FAZILKA	DS S/U S/D FAZILKA	0505F123	Salemah UPS	AMR	OK	31.03.2023	Category 5-UPS				5972	1200-600/5	1.333	NA	Director/D	
B.12735	West	MUKATSAR	11KV	DS DIVN. FAZILKA	DS S/U S/D FAZILKA	0505F101	Pami Sheri	AMR	OK	31.03.2023	AP 3Phase 3Wire				3160670	1200-600/5	1.141	NA	Director/D	
B.12736	West	MUKATSAR	11KV	DS DIVN. FAZILKA	DS S/U S/D FAZILKA	0505F102	Koran Wali	AMR	OK	31.03.2023	AP 3Phase 3Wire				8233325	1200-600/5	1.588	NA	Director/D	
B.12737	West	MUKATSAR	11KV	DS DIVN. FAZILKA	DS S/U S/D FAZILKA	0505F115	Korian Wali	AMR	OK	31.03.2023	AP 3Phase 3Wire				8222429	1200-600/5	1.759	NA	Director/D	
B.12738	West	MUKATSAR	11KV	DS DIVN. FAZILKA	DS S/U S/D FAZILKA	0505F113	Alam Shah	AMR	OK	31.03.2023	AP 3Phase 3Wire				777471	1200-600/5	1.993	NA	Director/D	
B.12739	West	MUKATSAR	11KV	DS DIVN. FAZILKA	DS S/U S/D FAZILKA	0505F101	BOP Mauzam Forward	AMR	OK	31.03.2023	Category 2				2067308	1200-600/5	1.995	NA	Director/D	
B.12740	West	MUKATSAR	11KV	DS DIVN. FAZILKA	DS S/U S/D FAZILKA	0505F105	Awa	AMR	OK	31.03.2023	AP 3Phase 3Wire				9141075	1200-600/5	1.998	NA	Director/D	

S.No	Zone	Circle	Voltage Level (kVA)	Division (kVA)	Sub-Division (kVA)	Feeder ID	Feeder Name	Feeder Metering Status (Metered/unmetered/AMR/AMI)	Status of Meter (Functional/Non-functional)	Metering Date (Date of last actual meter reading/communication)	Feeder Type (Agr/Industrial/Mixed)	Status of Communication				Period from 01.04.2021 to 31.03.2022				Sales	Remarks (Source of data)
												% data received through automatically if feeder AMR/AMI	Number of hours when meter was unable to communicate in week	Total Number of hours in the period	Meter S.No	CT/PT ratio	Import (kWh)	Export (kWh)			
B.12774	West	MUKATSAR	11kV	DS DIVN. GID0ARBAHA	DS CITY S/D GID0ARBAHA	C504FL07	RURAL	AMR	OK	31.03.2023	AP 3Phase 3Wire				8223250	400-200/5-5	0.732	NA	Director/D		
B.12775	West	MUKATSAR	11kV	DS DIVN. GID0ARBAHA	DS CITY S/D GID0ARBAHA	C504FL08	GAGHA	AMR	OK	31.03.2023	AP 3Phase 3Wire				8223248	400-200/5-5	0.845	NA	Director/D		
B.12776	West	MUKATSAR	11kV	DS DIVN. GID0ARBAHA	DS CITY S/D GID0ARBAHA	C504FL02	11kv disposal	AMR	OK	31.03.2023	Category 1				7042885	400-200/5-5	1.285	NA	Director/D		
B.12777	West	MUKATSAR	11kV	DS DIVN. GID0ARBAHA	DS CITY S/D GID0ARBAHA	C504FL10	KALIA	AMR	OK	31.03.2023	Category 5-U/PS				6746764	400-200/5-5	2.553	NA	Director/D		
B.12778	West	MUKATSAR	11kV	DS DIVN. GID0ARBAHA	DS CITY S/D GID0ARBAHA	C504FL14	11 kv Jandla	AMR	OK	31.03.2023	Category 5-U/PS				9154402	400-200/5-5	8.116	NA	Director/D		
B.12779	West	MUKATSAR	11kV	DS DIVN. GID0ARBAHA	DS CITY S/D GID0ARBAHA	C504FL09	MARKFED	AMR	OK	31.03.2023	Category 1				8222945	400-200/5-5	8.752	NA	Director/D		
B.12780	West	MUKATSAR	11kV	DS DIVN. GID0ARBAHA	DS CITY S/D GID0ARBAHA	C504FL01	HUSNAR	AMR	OK	31.03.2023	Category 1				9534372	400-200/5-5	9.584	NA	Director/D		
B.12781	West	MUKATSAR	11kV	DS DIVN. GID0ARBAHA	DS CITY S/D GID0ARBAHA	C504FL15	giderbaha	AMR	OK	31.03.2023	Category 1				9154165	400-200/5-5	12.257	NA	Director/D		
B.12782	West	MUKATSAR	11kV	DS DIVN. GID0ARBAHA	DS CITY S/D GID0ARBAHA	C504FL03	TOWN	AMR	OK	31.03.2023	Category 1				2068135	400-200/5-5	12.904	NA	Director/D		
B.12783	West	MUKATSAR	11kV	DS DIVN. GID0ARBAHA	DS CITY S/D GID0ARBAHA	C503FL04	THERI	AMR	OK	31.03.2023	Category 5-U/PS				9568154	1200-600/5	9.913	NA	Director/D		
B.12784	West	MUKATSAR	11kV	DS DIVN. GID0ARBAHA	DS CITY S/D GID0ARBAHA	D502002	11 KV COURT COMPLEX	AMR	OK	31.03.2023	Category 1				16198475	1200-600/5	2.198	NA	Director/D		
B.12785	West	MUKATSAR	11kV	DS DIVN. GID0ARBAHA	DS CITY S/D GID0ARBAHA	D502003	Bharu chowk	AMR	OK	31.03.2023	Category 5-U/PS				16198475	1200-600/5	7.714	NA	Director/D		
B.12786	West	MUKATSAR	11kV	DS DIVN. GID0ARBAHA	DS CITY S/D GID0ARBAHA	D502001	11 KV Industrial Feeder	AMR	OK	31.03.2023	Category 1				16194454	1200-600/5	9.505	NA	Director/D		
B.12787	West	MUKATSAR	11kV	DS DIVN. GID0ARBAHA	DS CITY S/D GID0ARBAHA	T544FL03	BHARU UPS	AMR	OK	31.03.2023	Category 5-U/PS				10229994	900-450/5	8.497	NA	Director/D		
B.12788	West	MUKATSAR	11kV	DS DIVN. GID0ARBAHA	DS CITY S/D GID0ARBAHA	D548T12	PEORI AP NEW	AMR	OK	31.03.2023	AP 3Phase 3Wire				12093533	900-450/5/7/1-1-1	1.207	NA	Director/D		
B.12789	West	MUKATSAR	11kV	DS DIVN. GID0ARBAHA	DS CITY S/D GID0ARBAHA	D548T11	PEORI CAT-1	AMR	OK	31.03.2023	Category 1				12093532	900-450/5/7/1-1-1	3.629	NA	Director/D		
B.12790	West	MUKATSAR	11kV	DS DIVN. GID0ARBAHA	DS CITY S/D GID0ARBAHA	D523FL07	hotline	AMR	OK	31.03.2023	Category 1				30283	900-450/5	0.000	NA	Director/D		
B.12791	West	MUKATSAR	11kV	DS DIVN. GID0ARBAHA	DS CITY S/D GID0ARBAHA	D523FL06	lekasar	AMR	OK	31.03.2023	AP 3Phase 3Wire				10273804	900-450/5	0.664	NA	Director/D		
B.12792	West	MUKATSAR	11kV	DS DIVN. GID0ARBAHA	DS CITY S/D GID0ARBAHA	D523FL05	Canal	AMR	OK	31.03.2023	AP 3Phase 3Wire				7336866	900-450/5	1.164	NA	Director/D		
B.12793	West	MUKATSAR	11kV	DS DIVN. GID0ARBAHA	DS CITY S/D GID0ARBAHA	D523FL02	Lalbi	AMR	OK	31.03.2023	Category 5-U/PS				2061882	900-450/5	1.270	NA	Director/D		
B.12794	West	MUKATSAR	11kV	DS DIVN. GID0ARBAHA	DS CITY S/D GID0ARBAHA	D523FL03	Dhoulu Kingra	AMR	OK	31.03.2023	AP 3Phase 3Wire				7341746	900-450/5	1.870	NA	Director/D		
B.12795	West	MUKATSAR	11kV	DS DIVN. GID0ARBAHA	DS CITY S/D GID0ARBAHA	D523FL01	Tharawala	AMR	OK	31.03.2023	Category 1				7336512	900-450/5	4.659	NA	Director/D		
B.12796	West	MUKATSAR	11kV	DS DIVN. GID0ARBAHA	DS CITY S/D GID0ARBAHA	D523FL04	Dhoulu Kingra	AMR	OK	31.03.2023	Category 5-U/PS				7336824	900-450/5	9.702	NA	Director/D		
B.12797	West	MUKATSAR	11kV	DS DIVN. GID0ARBAHA	DS S/D DODA	E513FL01	11KV MALLAN (AP)	AMR	OK	31.03.2023	AP 3Phase 3Wire				9544880	900-450/5	1.479	NA	Director/D		
B.12798	West	MUKATSAR	11kV	DS DIVN. GID0ARBAHA	DS S/D DODA	D539FL03	11KV THOLUKOT (AP)	AMR	OK	31.03.2023	AP 3Phase 3Wire				11116805	900-450/5	1.557	NA	Director/D		
B.12799	West	MUKATSAR	11kV	DS DIVN. GID0ARBAHA	DS S/D DODA	E513FL07	11KV BUTTERSARH (AP)	AMR	OK	31.03.2023	AP 3Phase 3Wire				2061882	900-450/5	2.293	NA	Director/D		
B.12800	West	MUKATSAR	11kV	DS DIVN. GID0ARBAHA	DS S/D DODA	D523FL04	11 Khirkwala	NON AMR	OK	31.03.2023	AP 3Phase 3Wire				9154482	900-450/5	0.435	NA	Director/D		
B.12801	West	MUKATSAR	11kV	DS DIVN. GID0ARBAHA	DS S/D DODA	D11FL03	DERA BABA KISHAN DAS	NON AMR	OK	31.03.2023	AP 3Phase 3Wire				23505	400-200/5-5	0.647	NA	Director/D		
B.12802	West	MUKATSAR	11kV	DS DIVN. GID0ARBAHA	DS S/D DODA	D11M02	KOTHE CHANDSINGH	NON AMR	OK	31.03.2023	AP 3Phase 3Wire				23450	400-200/5-5	0.869	NA	Director/D		
B.12803	West	MUKATSAR	11kV	DS DIVN. GID0ARBAHA	DS S/D DODA	D11MFL04	KOTHE KASHER SINGH	NON AMR	OK	31.03.2023	AP 3Phase 3Wire				23514	400-200/5-5	1.265	NA	Director/D		
B.12804	West	MUKATSAR	11kV	DS DIVN. GID0ARBAHA	DS S/D DODA	D11M01	DEDA	AMR	OK	31.03.2023	Category 5-U/PS				23510	400-200/5-5	10.432	NA	Director/D		
B.12805	West	MUKATSAR	11kV	DS DIVN. GID0ARBAHA	DS S/D DODA	D537FL03	11KV GILZEWALA SURGAPURI AP	AMR	OK	31.03.2023	AP 3Phase 3Wire				777322	900-450/5	0.319	NA	Director/D		
B.12806	West	MUKATSAR	11kV	DS DIVN. GID0ARBAHA	DS S/D DODA	D537FL08	sarnag ap	AMR	OK	31.03.2023	AP 3Phase 3Wire				777389	900-450/5	0.677	NA	Director/D		
B.12807	West	MUKATSAR	11kV	DS DIVN. GID0ARBAHA	DS S/D DODA	D537FL05	11KV GILZEWALA Gurdwara (AP)	AMR	OK	31.03.2023	AP 3Phase 3Wire				777520	900-450/5	1.220	NA	Director/D		
B.12808	West	MUKATSAR	11kV	DS DIVN. GID0ARBAHA	DS S/D DODA	D537FL04	11KV GILZEWALA UPS	AMR	OK	31.03.2023	Category 5-U/PS				7336418	900-450/5	3.516	NA	Director/D		
B.12809	West	MUKATSAR	11kV	DS DIVN. GID0ARBAHA	DS S/D DODA	D537FL09	CHAK GILZEWALA	AMR	OK	31.03.2023	Category 5-U/PS				5320	900-450/5	6.582	NA	Director/D		
B.12810	West	MUKATSAR	11kV	DS DIVN. GID0ARBAHA	DS S/D DODA	D504FL04	11KV KHIRKANWALA (AP)	AMR	OK	31.03.2023	AP 3Phase 3Wire				2066360	900-450/5/7/1-1-1	1.016	NA	Director/D		
B.12811	West	MUKATSAR	11kV	DS DIVN. GID0ARBAHA	DS S/D DODA	D504FL01	11KV Doda (AP)	AMR	OK	31.03.2023	AP 3Phase 3Wire				2066355	900-450/5/7/1-1-1	1.011	NA	Director/D		
B.12812	West	MUKATSAR	11kV	DS DIVN. GID0ARBAHA	DS S/D DODA	D504FL08	11 KV Kauri (AP)	AMR	OK	31.03.2023	AP 3Phase 3Wire				777966	900-450/5/7/1-1-1	1.022	NA	Director/D		
B.12813	West	MUKATSAR	11kV	DS DIVN. GID0ARBAHA	DS S/D DODA	D504FL07	BHULLAR AP	AMR	OK	31.03.2023	AP 3Phase 3Wire				33494	900-450/5/7/1-1-1	1.152	NA	Director/D		
B.12814	West	MUKATSAR	11kV	DS DIVN. GID0ARBAHA	DS S/D DODA	D504FL06	11 kv Bhubar	AMR	OK	31.03.2023	Category 5-U/PS				33404	900-450/5/7/1-1-1	4.680	NA	Director/D		
B.12815	West	MUKATSAR	11kV	DS DIVN. GID0ARBAHA	DS S/D DODA	D504FL05	MALLAN UPS	AMR	OK	31.03.2023	Category 5-U/PS				2066533	900-450/5/7/1-1-1	4.811	NA	Director/D		
B.12816	West	MUKATSAR	11kV	DS DIVN. GID0ARBAHA	DS S/D DODA	D504FL03	11KV MAJANI CAT-1	NON AMR	OK	31.03.2023	Category 5-U/PS				2069809	900-450/5/7/1-1-1	1.405	NA	Director/D		
B.12817	West	MUKATSAR	11kV	DS DIVN. GID0ARBAHA	DS S/D DODA	D10M03	Mallan	NON AMR	OK	31.03.2023	AP 3Phase 3Wire				23457	400-200/5-5	2.162	NA	Director/D		
B.12818	West	MUKATSAR	11kV	DS DIVN. GID0ARBAHA	DS S/D DODA	D10M02	KOTHE AMANGARI	NON AMR	OK	31.03.2023	AP 3Phase 3Wire				25804	400-200/5-5	2.229	NA	Director/D		
B.12819	West	MUKATSAR	11kV	DS DIVN. GID0ARBAHA	DS S/D DODA	D11MFL05	Mhallan KOTHE	NON AMR	OK	31.03.2023	Category 5-U/PS				233000	400-200/5-5	2.845	NA	Director/D		
B.12820	West	MUKATSAR	11kV	DS DIVN. GID0ARBAHA	DS S/D DODA	D10M01	Dhullukot	AMR	OK	31.03.2023	Category 5-U/PS				23432	400-200/5-5	5.902	NA	Director/D		
B.12821	West	MUKATSAR	11kV	DS DIVN. GID0ARBAHA	DS S/D DODA	D539FL01	11KV KURNHA ABLU (AP)	AMR	OK	31.03.2023	AP 3Phase 3Wire				53031	900-450/5	1.494	NA	Director/D		
B.12822	West	MUKATSAR	11kV	DS DIVN. GID0ARBAHA	DS S/D DODA	D538FL02	11 KV LOHARA (AP)	AMR	OK	31.03.2023	AP 3Phase 3Wire				5300	900-450/5	1.591	NA	Director/D		
B.12823	West	MUKATSAR	11kV	DS DIVN. GID0ARBAHA	DS S/D DODA	D513FL04	11 KV Sukhma Ablu	AMR	OK	31.03.2023	Category 1				23726	900-450/5	3.969	NA	Director/D		
B.12824	West	MUKATSAR	11kV	DS DIVN. GID0ARBAHA	DS S/D DODA	D538FL03	11KV LOHARA UPS	AMR	OK	31.03.2023	Category 5-U/PS				5241	900-450/5	6.885	NA	Director/D		
B.12825	West	MUKATSAR	11kV	DS DIVN. GID0ARBAHA	DS S/D DODA	D513FL09	11 kv Guri Sangar AP	AMR	OK	31.03.2023	AP 3Phase 3Wire				4735	400-200/5-5	1.427	NA	Director/D		
B.12826	West	MUKATSAR	11kV	DS DIVN. GID0ARBAHA	DS S/D DODA	E513FL04	11KV WADARISHANPURA (AP)	AMR	OK	31.03.2023	AP 3Phase 3Wire				9154305	400-200/5-5	1.468	NA	Director/D		
B.12827	West	MUKATSAR	11kV	DS DIVN. GID0ARBAHA	DS S/D DODA	E513FL03	11KV MALLAN	AMR	OK	31.03.2023	Category 5-U/PS				2068363	900-450/5	3.429	NA	Director/D		
B.12828	West	MUKATSAR	11kV	DS DIVN. GID0ARBAHA	DS S/D DODA	E513FL07	11KV MADARISHANPURA UPS	AMR	OK	31.03.2023	AP 3Phase 3Wire				10238397	400-200/5-5	1.757	NA	Director/D		
B.12829	West	MUKATSAR	11kV	DS DIVN. GID0ARBAHA	DS S/D DODA	D513FL10	11 kv Guri Sangar UPS	AMR	OK	31.03.2023	Category 1				4775	400-200/5-5	5.984	NA	Director/D		
B.12830	West	MUKATSAR	11kV	DS DIVN. GID0ARBAHA	DS S/U S/D GID0ARBAHA	C507FL08	AIRPORT	NON AMR	OK	31.03.2023	Category 1				11116876	400-200/5-5	0.172	NA	Director/D		
B.12831	West	MUKATSAR	11kV	DS DIVN. GID0ARBAHA	DS S/U S/D GID0ARBAHA	C507FL04	korhba AP	AMR	OK	31.03.2023	AP 3Phase 3Wire				73110922	1200/577/1-1-1	1.731	NA	Director/D		
B.12832	West	MUKATSAR	11kV	DS DIVN. GID0ARBAHA	DS S/U S/D GID0ARBAHA	D523FL02	11KV KARABAGARN SATRAN	AMR	OK	31.03.2023	AP 3Phase 3Wire				20616639	400-200/5-5	1.766	NA	Director/D		
B.12833	West	MUKATSAR	11kV	DS DIVN. GID0ARBAHA	DS S/U S/D GID0ARBAHA	C507FL01	11KV BALLIANA	AMR	OK	31.03.2023	Category 5-U/PS				5342721	400-200/5-5	6.700	NA	Director/D		
B.12834	West	MUKATSAR	11kV	DS DIVN. GID0ARBAHA	DS S/U S/D GID0ARBAHA	C507FL02	11KV WIRK KALAN	AMR	OK	31.03.2023	Category 5-U/PS				5388138	400-200/5-5	7.530	NA	Director/D		
B.12835	West	MUKATSAR	11kV	DS DIVN. GID0ARBAHA	DS S/U S/D GID0ARBAHA	C504FL04	11KV HJUMBA	AMR	OK	31.03.2023	AP 3Phase 3Wire				6740747	400-200/5-5	0.38				

S.No	Zone	Circle	Village (kVA)	Division (kVA)	Sub-Division (kVA)	Feeder ID	Feeder Name	Feeder Metering Status (Metered/unmetered/ AMR/AM)	Status of Meter (Functional/Non- functional)	Metering Date Date of last actual meter reading/ communication	Feeder Type (Agr/ Industrial/Mixed)	Status of Communication			Period from 01.04.2021 to 31.03.2022				Sales	Remarks (Source of data)
												% data received through automatically if feeder AMR/AM	Number of hours when meter was unable to communicate in total	Total Number of hours in the period	Meter S.No	CT/PT ratio	Import (kWh)	Export (kWh)		
B.12871	West	MUKATSAR	11KV	DS DIVN. MALOUT	DS CITY S/D MALOUT	C503FL12	Guru Nanak Nagri	NON AMR	OK	31.03.2023	Category 1			9568167	1200-600/5	13,260	NA	Director/D		
B.12872	West	MUKATSAR	11KV	DS DIVN. MALOUT	DS CITY S/D MALOUT	T501FL01	SARABHA NAGAR	AMR	OK	31.03.2023	Category 1			2288	1200-600/5	2,819	NA	Director/D		
B.12873	West	MUKATSAR	11KV	DS DIVN. MALOUT	DS CITY S/D MALOUT	T501FL06	Karoon road	AMR	OK	31.03.2023	Category 1			2270	1200-600/5	4,417	NA	Director/D		
B.12874	West	MUKATSAR	11KV	DS DIVN. MALOUT	DS CITY S/D MALOUT	T501FL07	SEI MAIN ROAD	NON AMR	OK	31.03.2023	Category 1			4821	1200-600/5	6,947	NA	Director/D		
B.12875	West	MUKATSAR	11KV	DS DIVN. MALOUT	DS CITY S/D MALOUT	T501FL02	Tehsil road	NON AMR	OK	31.03.2023	Category 1			2827	1200-600/5	10,005	NA	Director/D		
B.12876	West	MUKATSAR	11KV	DS DIVN. MALOUT	DS CITY S/D MALOUT	T501FL03	Main Bazar	AMR	OK	31.03.2023	Category 1			2289	1200-600/5	12,288	NA	Director/D		
B.12877	West	MUKATSAR	11KV	DS DIVN. MALOUT	DS CITY S/D MALOUT	B502FL01	Muktar Road INDUSTRIAL	AMR	OK	31.03.2023	Category 1			10282755	1200-600/5	7,453	NA	Director/D		
B.12878	West	MUKATSAR	11KV	DS DIVN. MALOUT	DS S/D ABUL KHURANA	D533FL11	DANEWALA AP	AMR	OK	31.03.2023	AP 3Phase 3Wire			4644	900-450/577/1-1	0,770	NA	Director/D		
B.12879	West	MUKATSAR	11KV	DS DIVN. MALOUT	DS S/D ABUL KHURANA	D533FL12	SUKHCHHAP AP	AMR	OK	31.03.2023	AP 3Phase 3Wire			5390	900-450/577/1-1	1,016	NA	Director/D		
B.12880	West	MUKATSAR	11KV	DS DIVN. MALOUT	DS S/D ABUL KHURANA	D533FL02	Tapga Khera	AMR	OK	31.03.2023	AP 3Phase 3Wire			777768	900-450/577/1-1	1,463	NA	Director/D		
B.12881	West	MUKATSAR	11KV	DS DIVN. MALOUT	DS S/D ABUL KHURANA	D533FL05	Focal Point	AMR	OK	31.03.2023	Category 1			6761978	900-450/577/1-1	1,470	NA	Director/D		
B.12882	West	MUKATSAR	11KV	DS DIVN. MALOUT	DS S/D ABUL KHURANA	D533FL01	Dabwali Malika (AP)	AMR	OK	31.03.2023	AP 3Phase 3Wire			12479575	900-450/577/1-1	1,695	NA	Director/D		
B.12883	West	MUKATSAR	11KV	DS DIVN. MALOUT	DS S/D ABUL KHURANA	D533FL06	Mahana (AP)	AMR	OK	31.03.2023	AP 3Phase 3Wire			11052088	900-450/577/1-1	1,863	NA	Director/D		
B.12884	West	MUKATSAR	11KV	DS DIVN. MALOUT	DS S/D ABUL KHURANA	D533FL03	Abul Khurana (AP)	AMR	OK	31.03.2023	AP 3Phase 3Wire			74151941	900-450/577/1-1	1,945	NA	Director/D		
B.12885	West	MUKATSAR	11KV	DS DIVN. MALOUT	DS S/D ABUL KHURANA	D533FL04	Srinidhi Canal	AMR	OK	31.03.2023	Category 5 UPS			2067216	900-450/577/1-1	4,390	NA	Director/D		
B.12886	West	MUKATSAR	11KV	DS DIVN. MALOUT	DS S/D ABUL KHURANA	D533FL07	abulkhurana cat-1	AMR	OK	31.03.2023	Category 1			2067139	900-450/577/1-1	5,698	NA	Director/D		
B.12887	West	MUKATSAR	11KV	DS DIVN. MALOUT	DS S/D ABUL KHURANA	E507FL10	Deen Khera UPS	NON AMR	OK	31.03.2023	Category 5 UPS			73151976	900-450/577/1-1	5,769	NA	Director/D		
B.12888	West	MUKATSAR	11KV	DS DIVN. MALOUT	DS S/D ABUL KHURANA	T002FL06	PHULLU KHERA AP	AMR	OK	31.03.2023	AP 3Phase 3Wire			4192	1200-600/5	0,885	NA	Director/D		
B.12889	West	MUKATSAR	11KV	DS DIVN. MALOUT	DS S/D ABUL KHURANA	T002FL05	Khema Khera (AP)	NON AMR	OK	31.03.2023	AP 3Phase 3Wire			15193778	1200-600/5	1,370	NA	Director/D		
B.12890	West	MUKATSAR	11KV	DS DIVN. MALOUT	DS S/D ABUL KHURANA	T002FL02	BHAI KERA (AP)	NON AMR	OK	31.03.2023	AP 3Phase 3Wire			23446	1200-600/5	1,615	NA	Director/D		
B.12891	West	MUKATSAR	11KV	DS DIVN. MALOUT	DS S/D ABUL KHURANA	T002FL01	BHAI KEBA	NON AMR	OK	31.03.2023	Category 1			23542	1200-600/5	1,994	NA	Director/D		
B.12892	West	MUKATSAR	11KV	DS DIVN. MALOUT	DS S/D ABUL KHURANA	T002FL03	KHEMA KHERA	NON AMR	OK	31.03.2023	Category 5 UPS			23353	1200-600/5	4,244	NA	Director/D		
B.12893	West	MUKATSAR	11KV	DS DIVN. MALOUT	DS S/D ABUL KHURANA	T002FL04	Balockhera	AMR	OK	31.03.2023	Category 5 UPS			23755	1200-600/5	9,236	NA	Director/D		
B.12894	West	MUKATSAR	11KV	DS DIVN. MALOUT	DS S/D ABUL KHURANA	D518FL09	Teljan wali Dhani AP	AMR	OK	31.03.2023	AP 3Phase 3Wire			12093419	900-450/577/1-1	2,530	NA	Director/D		
B.12895	West	MUKATSAR	11KV	DS DIVN. MALOUT	DS S/D ABUL KHURANA	D518FL08	Tarmala UPS	AMR	OK	31.03.2023	Category 5 UPS			5154109	900-450/577/1-1	8,782	NA	Director/D		
B.12896	West	MUKATSAR	11KV	DS DIVN. MALOUT	DS S/D ABUL KHURANA	T551FL05	Kharu khara AP	AMR	OK	31.03.2023	AP 3Phase 3Wire			772795	900-450/577/1-1	1,174	NA	Director/D		
B.12897	West	MUKATSAR	11KV	DS DIVN. MALOUT	DS S/D ABUL KHURANA	T551FL02	DHABWALI DHAB AP	AMR	OK	31.03.2023	AP 3Phase 3Wire			777293	900-450/577/1-1	1,393	NA	Director/D		
B.12898	West	MUKATSAR	11KV	DS DIVN. MALOUT	DS S/D ABUL KHURANA	T551FL03	GURUSAR JODHA AP	NON AMR	OK	31.03.2023	AP 3Phase 3Wire			777650	900-450/577/1-1	2,518	NA	Director/D		
B.12899	West	MUKATSAR	11KV	DS DIVN. MALOUT	DS S/D ABUL KHURANA	T551FL01	DHABWALI DHAB CAT-1	AMR	OK	31.03.2023	Category 1			30333	900-450/577/1-1	3,280	NA	Director/D		
B.12900	West	MUKATSAR	11KV	DS DIVN. MALOUT	DS S/D ABUL KHURANA	T551FL04	SHAM KHERRA (UPS)	NON AMR	OK	31.03.2023	Category 5 UPS			30392	900-450/577/1-1	6,099	NA	Director/D		
B.12901	West	MUKATSAR	11KV	DS DIVN. MALOUT	DS S/D ABUL KHURANA	D019FL03	Behraia AP	NON AMR	OK	31.03.2023	AP 3Phase 3Wire			5746	900-450/577/1-1	0,118	NA	Director/D		
B.12902	West	MUKATSAR	11KV	DS DIVN. MALOUT	DS S/D ABUL KHURANA	D019FL06	11 KV FEEDER FOCAL POINT CAT-2	NON AMR	OK	31.03.2023	Category 2			6981	900-450/577/1-1	0,441	NA	Director/D		
B.12903	West	MUKATSAR	11KV	DS DIVN. MALOUT	DS S/D ABUL KHURANA	D019FL04	Ghumaria UPS	AMR	OK	31.03.2023	Category 5 UPS			5723	900-450/577/1-1	0,760	NA	Director/D		
B.12904	West	MUKATSAR	11KV	DS DIVN. MALOUT	DS S/D ABUL KHURANA	D034FL03	Phullu Khera	AMR	OK	31.03.2023	AP 3Phase 3Wire			2068790	900-450/577/1-1	1,522	NA	Director/D		
B.12905	West	MUKATSAR	11KV	DS DIVN. MALOUT	DS S/D ABUL KHURANA	E508FL06	ARNIWALA AP	AMR	OK	31.03.2023	AP 3Phase 3Wire			4602	900-450/577/1-1	1,599	NA	Director/D		
B.12906	West	MUKATSAR	11KV	DS DIVN. MALOUT	DS S/D ABUL KHURANA	D534FL02	Maniwala Rural	AMR	OK	31.03.2023	AP 3Phase 3Wire			4179734	900-450/577/1-1	1,870	NA	Director/D		
B.12907	West	MUKATSAR	11KV	DS DIVN. MALOUT	DS S/D ABUL KHURANA	D534FL01	Deen Khera (AP)	AMR	OK	31.03.2023	AP 3Phase 3Wire			11562070	900-450/577/1-1	1,875	NA	Director/D		
B.12908	West	MUKATSAR	11KV	DS DIVN. MALOUT	DS S/D ABUL KHURANA	D534FL01	Fatehaur Tehsil AP	AMR	OK	31.03.2023	Category 1			910234	900-450/577/1-1	4,421	NA	Director/D		
B.12909	West	MUKATSAR	11KV	DS DIVN. MALOUT	DS S/D ABUL KHURANA	D534FL04	Sherawali	AMR	OK	31.03.2023	Category 5 UPS			4835	900-450/577/1-1	6,676	NA	Director/D		
B.12910	West	MUKATSAR	11KV	DS DIVN. MALOUT	DS S/D ABUL KHURANA	D535FL04	Sham Khera	AMR	OK	31.03.2023	AP 3Phase 3Wire			2995266	900-450/577/1-1	0,534	NA	Director/D		
B.12911	West	MUKATSAR	11KV	DS DIVN. MALOUT	DS S/D ABUL KHURANA	D535FL07	Dhani Kundan Singh (AP)	AMR	OK	31.03.2023	AP 3Phase 3Wire			777769	900-450/5	0,919	NA	Director/D		
B.12912	West	MUKATSAR	11KV	DS DIVN. MALOUT	DS S/D ABUL KHURANA	D535FL02	Buraj Sidhwan (AP)	AMR	OK	31.03.2023	AP 3Phase 3Wire			1027373	900-450/577/1-1	1,505	NA	Director/D		
B.12913	West	MUKATSAR	11KV	DS DIVN. MALOUT	DS S/D ABUL KHURANA	D535FL08	GHATHIANWALI AP	AMR	OK	31.03.2023	AP 3Phase 3Wire			11117076	900-450/5	1,420	NA	Director/D		
B.12914	West	MUKATSAR	11KV	DS DIVN. MALOUT	DS S/D ABUL KHURANA	D535FL09	NAWA PIND AP	AMR	OK	31.03.2023	AP 3Phase 3Wire			4504	900-450/577/1-1	1,623	NA	Director/D		
B.12915	West	MUKATSAR	11KV	DS DIVN. MALOUT	DS S/D ABUL KHURANA	D535FL03	Kollianwal	AMR	OK	31.03.2023	Category 1			1955861	900-450/5	1,842	NA	Director/D		
B.12916	West	MUKATSAR	11KV	DS DIVN. MALOUT	DS S/D ABUL KHURANA	D535FL05	Kangan Khera (AP)	AMR	OK	31.03.2023	AP 3Phase 3Wire			777387	900-450/5	2,202	NA	Director/D		
B.12917	West	MUKATSAR	11KV	DS DIVN. MALOUT	DS S/D ABUL KHURANA	D535FL01	Guruar Jodha	AMR	OK	31.03.2023	Category 5 UPS			16194345	900-450/577/1-1	3,930	NA	Director/D		
B.12918	West	MUKATSAR	11KV	DS DIVN. MALOUT	DS S/D ABUL KHURANA	D535FL06	Mahana (AP)	NON AMR	OK	31.03.2023	Category 5 UPS			1955865	900-450/5	0,404	NA	Director/D		
B.12919	West	MUKATSAR	11KV	DS DIVN. MALOUT	DS S/D ABUL KHURANA	T7N105	Bahadar Khera UPS	AMR	OK	31.03.2023	Category 5 UPS			6018	400-200/5-5	0,033	NA	Director/D		
B.12920	West	MUKATSAR	11KV	DS DIVN. MALOUT	DS S/D ABUL KHURANA	E522FL04	Bhai Kera (AP)	AMR	OK	31.03.2023	AP 3Phase 3Wire			777194	900-450/5	1,419	NA	Director/D		
B.12921	West	MUKATSAR	11KV	DS DIVN. MALOUT	DS S/D ABUL KHURANA	T522FL06	BHAI KERA NEW AP	AMR	OK	31.03.2023	AP 3Phase 3Wire			11117193	900-450/5	1,694	NA	Director/D		
B.12922	West	MUKATSAR	11KV	DS DIVN. MALOUT	DS S/D ABUL KHURANA	E522FL01	Khuban (AP)	AMR	OK	31.03.2023	AP 3Phase 3Wire			777197	900-450/5	2,066	NA	Director/D		
B.12923	West	MUKATSAR	11KV	DS DIVN. MALOUT	DS S/D ARNIWALA	D531FL05	Dhappariwali	AMR	OK	31.03.2023	AP 3Phase 3Wire			777104	1200-600/5	0,889	NA	Director/D		
B.12924	West	MUKATSAR	11KV	DS DIVN. MALOUT	DS S/D ARNIWALA	D531FL03	Dabwali	AMR	OK	31.03.2023	AP 3Phase 3Wire			822105	1200-600/5	1,181	NA	Director/D		
B.12925	West	MUKATSAR	11KV	DS DIVN. MALOUT	DS S/D ARNIWALA	D531FL07	Dabwali	AMR	OK	31.03.2023	AP 3Phase 3Wire			777105	1200-600/5	1,286	NA	Director/D		
B.12926	West	MUKATSAR	11KV	DS DIVN. MALOUT	DS S/D ARNIWALA	D531FL02	Jandwala	AMR	OK	31.03.2023	AP 3Phase 3Wire			8222914	1200-600/5	2,027	NA	Director/D		
B.12927	West	MUKATSAR	11KV	DS DIVN. MALOUT	DS S/D ARNIWALA	D531FL01	Tahlawala	AMR	OK	31.03.2023	Category 5 UPS			5342131	1200-600/5	3,847	NA	Director/D		
B.12928	West	MUKATSAR	11KV	DS DIVN. MALOUT	DS S/D ARNIWALA	D531FL06	Mahana	AMR	OK	31.03.2023	Category 5 UPS			5342154	1200-600/5	7,376	NA	Director/D		
B.12929	West	MUKATSAR	11KV	DS DIVN. MALOUT	DS S/D ARNIWALA	D531FL12	BALLIARWALI UPS	AMR	OK	31.03.2023	Category 5 UPS			1051863	1200-600/5	8,475	NA	Director/D		
B.12930	West	MUKATSAR	11KV	DS DIVN. MALOUT																

S.No	Zone	Circle	Voltage Level (kVA)	Division (kVA)	Sub-Division (kVA)	Feeder ID	Feeder Name	Feeder Metering Status (Metered/unmetered/AM/AMR)	Status of Meter (Functional/Non-Functional)	Metering Date	Date of last actual meter reading/communication	Feeder Type (Agr./Industrial/Mixed)	Status of Communication				Period from 01.04.2021 to 31.03.2022				Sales	Remarks (Source of data)
													% data received through automatically if feeder AMR/AMI	Number of hours when meter was unable to communicate in week	Total Number of hours in the period	Meter S.No	CT/PT ratio	Import (kU)	Export (kU)			
B.12968	West	MUKATSAR	11KV	D5 DIVN. MALOUT	D5 S/U S/D MALOUT	0529FL07	Badiyan	AMR	OK	31.03.2023	31.03.2023	AP 3Phase 3Wire	5341556	400-200/5-5	1419	NA	Director/D					
B.12969	West	MUKATSAR	11KV	D5 DIVN. MALOUT	D5 S/U S/D MALOUT	0529FL08	Ihorar 2	AMR	OK	31.03.2023	31.03.2023	AP 3Phase 3Wire	9153627	400-200/5-5	1790	NA	Director/D					
B.12970	West	MUKATSAR	11KV	D5 DIVN. MALOUT	D5 S/U S/D MALOUT	0529FL08	Saurke(UPS)	AMR	OK	31.03.2023	31.03.2023	Category 5-UPS	12479437	900-450/577/1-1-1	2.639	NA	Director/D					
B.12971	West	MUKATSAR	11KV	D5 DIVN. MALOUT	D5 S/U S/D MALOUT	0529FL09	BHUNER(UPS)	AMR	OK	31.03.2023	31.03.2023	Category 5-UPS	3180	400-200/5-5	7.338	NA	Director/D					
B.12972	West	MUKATSAR	11KV	D5 DIVN. MALOUT	D5 S/U S/D MALOUT	0529FL03	Focal Point	AMR	OK	31.03.2023	31.03.2023	Category 5-UPS	1957164	400-200/5-5	7.450	NA	Director/D					
B.12973	West	MUKATSAR	11KV	D5 DIVN. MALOUT	D5 S/U S/D MALOUT	T001FL05	lakkarwala ups	NON AMR	OK	31.03.2023	31.03.2023	Category 5-UPS	15193869	900-450/577/1-1-1	8.911	NA	Director/D					
B.12974	West	MUKATSAR	11KV	D5 DIVN. MALOUT	D5 S/U S/D MALOUT	T001FL03	Lakkarwala	NON AMR	OK	31.03.2023	31.03.2023	AP 3Phase 3Wire	23397	900-450/577/1-1-1	1.205	NA	Director/D					
B.12975	West	MUKATSAR	11KV	D5 DIVN. MALOUT	D5 S/U S/D MALOUT	T001FL01	Bhulerian	NON AMR	OK	31.03.2023	31.03.2023	Category 1	23404	900-450/577/1-1-1	1.720	NA	Director/D					
B.12976	West	MUKATSAR	11KV	D5 DIVN. MALOUT	D5 S/U S/D MALOUT	T001FL06	lakkarwala cat-5	NON AMR	OK	31.03.2023	31.03.2023	Category 5-UPS	8039	900-450/577/1-1-1	3.954	NA	Director/D					
B.12977	West	MUKATSAR	11KV	D5 DIVN. MALOUT	D5 S/U S/D MALOUT	0179FL05	DEFENCE ROAD	AMR	OK	31.03.2023	31.03.2023	Category 1	5733	900-450/577/1-1-1	1.564	NA	Director/D					
B.12978	West	MUKATSAR	11KV	D5 DIVN. MALOUT	D5 S/U S/D MALOUT	0179FL01	Danewala	NON AMR	OK	31.03.2023	31.03.2023	Category 1	7321131	900-450/577/1-1-1	5.630	NA	Director/D					
B.12979	West	MUKATSAR	11KV	D5 DIVN. MALOUT	D5 S/U S/D MALOUT	0520FL15	Kattianwall AP	NON AMR	OK	31.03.2023	31.03.2023	AP 3Phase 3Wire	37209	900-450/577/1-1-1	1.188	NA	Director/D					
B.12980	West	MUKATSAR	11KV	D5 DIVN. MALOUT	D5 S/U S/D MALOUT	0520FL08	Aspal (AP)	AMR	OK	31.03.2023	31.03.2023	AP 3Phase 3Wire	36977	900-450/577/1-1-1	1.302	NA	Director/D					
B.12981	West	MUKATSAR	11KV	D5 DIVN. MALOUT	D5 S/U S/D MALOUT	0520FL06	Saravan AP	AMR	OK	31.03.2023	31.03.2023	AP 3Phase 3Wire	10273753	900-450/577/1-1-1	1.303	NA	Director/D					
B.12982	West	MUKATSAR	11KV	D5 DIVN. MALOUT	D5 S/U S/D MALOUT	0520FL03	Robarawa	AMR	OK	31.03.2023	31.03.2023	AP 3Phase 3Wire	8223888	900-450/577/1-1-1	1.700	NA	Director/D					
B.12983	West	MUKATSAR	11KV	D5 DIVN. MALOUT	D5 S/U S/D MALOUT	0520FL04	Kattianwall 24 HRS	NON AMR	OK	31.03.2023	31.03.2023	Category 1	5343274	900-450/577/1-1-1	3.957	NA	Director/D					
B.12984	West	MUKATSAR	11KV	D5 DIVN. MALOUT	D5 S/U S/D MALOUT	0520FL05	Saravan UPS	NON AMR	OK	31.03.2023	31.03.2023	Category 5-UPS	37169	900-450/577/1-1-1	7.988	NA	Director/D					
B.12985	West	MUKATSAR	11KV	D5 DIVN. MALOUT	D5 S/U S/D MALOUT	T501FL05	KALGIDHAR G	NON AMR	OK	31.03.2023	31.03.2023	Category 1	2286	1200-600/5	10.353	NA	Director/D					
B.12986	West	MUKATSAR	11KV	D5 DIVN. MALOUT	D5 S/U S/D MALOUT	T501FL04	BHAI JAGTA JI	AMR	OK	31.03.2023	31.03.2023	Category 1	1725	1200-600/5	14.497	NA	Director/D					
B.12987	West	MUKATSAR	11KV	D5 DIVN. MALOUT	D5 S/U S/D MALOUT	0530FL08	MIDDA AP	AMR	OK	31.03.2023	31.03.2023	Category 1	15193868	900-450/577/1-1-1	0.430	NA	Director/D					
B.12988	West	MUKATSAR	11KV	D5 DIVN. MALOUT	D5 S/U S/D MALOUT	0530FL01	Boldiwala	AMR	OK	31.03.2023	31.03.2023	AP 3Phase 3Wire	6761893	900-450/577/1-1-1	0.455	NA	Director/D					
B.12989	West	MUKATSAR	11KV	D5 DIVN. MALOUT	D5 S/U S/D MALOUT	0530FL03	Rainwala	AMR	OK	31.03.2023	31.03.2023	AP 3Phase 3Wire	15194718	900-450/577/1-1-1	0.608	NA	Director/D					
B.12990	West	MUKATSAR	11KV	D5 DIVN. MALOUT	D5 S/U S/D MALOUT	0530FL05	Rainwala	AMR	OK	31.03.2023	31.03.2023	Category 5-UPS	4187118	900-450/577/1-1-1	4.609	NA	Director/D					
B.12991	West	MUKATSAR	11KV	D5 DIVN. MALOUT	D5 S/U S/D MALOUT	0530FL04	Midda	AMR	OK	31.03.2023	31.03.2023	Category 1	7336776	900-450/577/1-1-1	4.717	NA	Director/D					
B.12992	West	MUKATSAR	11KV	D5 DIVN. MALOUT	D5 S/U S/D MALOUT	8502FL04	ENNAKHERA	AMR	OK	31.03.2023	31.03.2023	AP 3Phase 3Wire	10282806	1200-600/5	0.517	NA	Director/D					
B.12993	West	MUKATSAR	11KV	D5 DIVN. MALOUT	D5 S/U S/D MALOUT	8502FL03	Kanwarh	AMR	OK	31.03.2023	31.03.2023	AP 3Phase 3Wire	10282787	1200-600/5	1.907	NA	Director/D					
B.12994	West	MUKATSAR	11KV	D5 DIVN. MALOUT	D5 S/U S/D MALOUT	8502FL02	Katowala	AMR	OK	31.03.2023	31.03.2023	Category 1	10282785	1200-600/5	2.554	NA	Director/D					
B.12995	West	MUKATSAR	11KV	D5 DIVN. MUKTSAR	D5 CITY S/D MUKTSAR	CS01FL10	DISPOSAL PARK	AMR	OK	31.03.2023	31.03.2023	Category 2	9568162	900-450/577/1-1-1	2.234	NA	Director/D					
B.12996	West	MUKATSAR	11KV	D5 DIVN. MUKTSAR	D5 CITY S/D MUKTSAR	CS01FL09	BATHINDA ROAD	AMR	OK	31.03.2023	31.03.2023	Category 1	9154160	1200-600/5	7.883	NA	Director/D					
B.12997	West	MUKATSAR	11KV	D5 DIVN. MUKTSAR	D5 CITY S/D MUKTSAR	CS01FL11	Railway Road	AMR	OK	31.03.2023	31.03.2023	Category 1	16199612	900-450/577/1-1-1	8.702	NA	Director/D					
B.12998	West	MUKATSAR	11KV	D5 DIVN. MUKTSAR	D5 CITY S/D MUKTSAR	CS01FL08	DARBAR SAHIB	AMR	OK	31.03.2023	31.03.2023	Category 1	9568241	900-450/577/1-1-1	9.009	NA	Director/D					
B.12999	West	MUKATSAR	11KV	D5 DIVN. MUKTSAR	D5 CITY S/D MUKTSAR	CS01FL03	SONANA	AMR	OK	31.03.2023	31.03.2023	Category 1	9154097	1200-600/5	9.364	NA	Director/D					
B.13000	West	MUKATSAR	11KV	D5 DIVN. MUKTSAR	D5 CITY S/D MUKTSAR	CS01FL06	TOWN	AMR	OK	31.03.2023	31.03.2023	Category 1	9568295	900-450/577/1-1-1	13.475	NA	Director/D					
B.13001	West	MUKATSAR	11KV	D5 DIVN. MUKTSAR	D5 CITY S/D MUKTSAR	8501FL01	MILITARY	AMR	OK	31.03.2023	31.03.2023	Category 1	9568160	900-450/577/1-1-1	0.030	NA	Director/D					
B.13002	West	MUKATSAR	11KV	D5 DIVN. MUKTSAR	D5 CITY S/D MUKTSAR	8501FL03	PILOT WORKSHOP	AMR	OK	31.03.2023	31.03.2023	Category 2	9568163	900-450/577/1-1-1	0.069	NA	Director/D					
B.13003	West	MUKATSAR	11KV	D5 DIVN. MUKTSAR	D5 CITY S/D MUKTSAR	8501FL07	UJDEY KARAN	AMR	OK	31.03.2023	31.03.2023	Category 5-UPS	9568138	900-450/577/1-1-1	3.539	NA	Director/D					
B.13004	West	MUKATSAR	11KV	D5 DIVN. MUKTSAR	D5 CITY S/D MUKTSAR	0510FL04	COLLEGE ROAD	AMR	OK	31.03.2023	31.03.2023	Category 1	9568132	900-450/577/1-1-1	5.865	NA	Director/D					
B.13005	West	MUKATSAR	11KV	D5 DIVN. MUKTSAR	D5 CITY S/D MUKTSAR	0510FL04	DISPOSAL WORKS	AMR	OK	31.03.2023	31.03.2023	Category 2	2066498	900-450/577/1-1-1	0.475	NA	Director/D					
B.13006	West	MUKATSAR	11KV	D5 DIVN. MUKTSAR	D5 CITY S/D MUKTSAR	0510FL06	Civil Hospital	NON AMR	OK	31.03.2023	31.03.2023	Category 1	10282949	900-450/577/1-1-1	1.611	NA	Director/D					
B.13007	West	MUKATSAR	11KV	D5 DIVN. MUKTSAR	D5 CITY S/D MUKTSAR	0510FL01	BUS STAND	AMR	OK	31.03.2023	31.03.2023	Category 1	2066439	900-450/577/1-1-1	4.086	NA	Director/D					
B.13008	West	MUKATSAR	11KV	D5 DIVN. MUKTSAR	D5 CITY S/D MUKTSAR	0510FL05	MUKT-E-MINAR	NON AMR	OK	31.03.2023	31.03.2023	Category 1	2067786	900-450/577/1-1-1	4.469	NA	Director/D					
B.13009	West	MUKATSAR	11KV	D5 DIVN. MUKTSAR	D5 CITY S/D MUKTSAR	0510FL11	11KV Dama Mandi	AMR	OK	31.03.2023	31.03.2023	Category 1	16199624	1200-600/5	6.015	NA	Director/D					
B.13010	West	MUKATSAR	11KV	D5 DIVN. MUKTSAR	D5 CITY S/D MUKTSAR	0510FL08	BAHAR ROAD	AMR	OK	31.03.2023	31.03.2023	Category 1	15193208	900-450/577/1-1-1	4.387	NA	Director/D					
B.13011	West	MUKATSAR	11KV	D5 DIVN. MUKTSAR	D5 CITY S/D MUKTSAR	0510FL03	RAHURANWALI	AMR	OK	31.03.2023	31.03.2023	Category 1	4186937	900-450/577/1-1-1	6.628	NA	Director/D					
B.13012	West	MUKATSAR	11KV	D5 DIVN. MUKTSAR	D5 CITY S/D MUKTSAR	0510FL02	ABOHAR ROAD	AMR	OK	31.03.2023	31.03.2023	Category 1	2067945	900-450/577/1-1-1	8.870	NA	Director/D					
B.13013	West	MUKATSAR	11KV	D5 DIVN. MUKTSAR	D5 CITY S/D MUKTSAR	0510FL09	11KV Tam Taran Sahib	NON AMR	OK	31.03.2023	31.03.2023	Category 1	16199604	1200-600/5	9.253	NA	Director/D					
B.13014	West	MUKATSAR	11KV	D5 DIVN. MUKTSAR	D5 CITY S/D MUKTSAR	0510FL10	11KV Balan Garh Road	AMR	OK	31.03.2023	31.03.2023	Category 1	16199603	1200-600/5	12.635	NA	Director/D					
B.13015	West	MUKATSAR	11KV	D5 DIVN. MUKTSAR	D5 S/D BARIWALA	CS02FL01	WARWALA	AMR	OK	31.03.2023	31.03.2023	AP 3Phase 3Wire	620648	900-450/577/1-1-1	0.066	NA	Director/D					
B.13016	West	MUKATSAR	11KV	D5 DIVN. MUKTSAR	D5 S/D BARIWALA	CS02FL05	BAJA MARAR	AMR	OK	31.03.2023	31.03.2023	AP 3Phase 3Wire	45036	1200-600/5	1.028	NA	Director/D					
B.13017	West	MUKATSAR	11KV	D5 DIVN. MUKTSAR	D5 S/D BARIWALA	CS02FL15	Warning AP	AMR	OK	31.03.2023	31.03.2023	AP 3Phase 3Wire	5588	1200-600/5	1.043	NA	Director/D					
B.13018	West	MUKATSAR	11KV	D5 DIVN. MUKTSAR	D5 S/D BARIWALA	CS0214	11 KV War Sahib	AMR	OK	31.03.2023	31.03.2023	AP 3Phase 3Wire	45147	1200-600/5	1.074	NA	Director/D					
B.13019	West	MUKATSAR	11KV	D5 DIVN. MUKTSAR	D5 S/D BARIWALA	CS02FL07	HARI KE KALAN	AMR	OK	31.03.2023	31.03.2023	AP 3Phase 3Wire	45201	1200-600/5	1.340	NA	Director/D					
B.13020	West	MUKATSAR	11KV	D5 DIVN. MUKTSAR	D5 S/D BARIWALA	CS02FL04	PHIDE KALAN	AMR	OK	31.03.2023	31.03.2023	AP 3Phase 3Wire	45149	1200-600/5	2.092	NA	Director/D					
B.13021	West	MUKATSAR	11KV	D5 DIVN. MUKTSAR	D5 S/D BARIWALA	CS02FL06	MARAN KALAN	AMR	OK	31.03.2023	31.03.2023	Category 5-UPS	10283030	900-450/577/1-1-1	2.192	NA	Director/D					
B.13022	West	MUKATSAR	11KV	D5 DIVN. MUKTSAR	D5 S/D BARIWALA	F109CS02	Sarainaga	AMR	OK	31.03.2023	31.03.2023	Category 5-UPS	7336641	1200-600/5	3.026	NA	Director/D					
B.13023	West	MUKATSAR	11KV	D5 DIVN. MUKTSAR	D5 S/D BARIWALA	CS02FL03	INDUSTRIAL	AMR	OK	31.03.2023	31.03.2023	Category 1	45155	1200-600/5	3.677	NA	Director/D					
B.13024	West	MUKATSAR	11KV	D5 DIVN. MUKTSAR	D5 S/D BARIWALA	CS02FL02	WARING	AMR	OK	31.03.2023	31.03.2023	Category 5-UPS	45006	1200-600/5	6.197	NA	Director/D					
B.13025	West	MUKATSAR	11KV	D5 DIVN. MUKTSAR	D5 S/D BARIWALA	CS02FL14	Bariwala	AMR	OK	31.03.2023	31.03.2023	Category 5-UPS	3175	1200-600/5	9.374	NA	Director/D					
B.13026	West	MUKATSAR	11KV	D5 DIVN. MUKTSAR	D5 S/D BARIWALA	8502FL08	HARKE KALAN UPS	AMR	OK	31.03.2023	31.03.2023	Category 5-UPS	45123	900-450/577/1-1-1	9.506	NA	Director/D					
B.13027	West	MUKATSAR	11KV	D5 DIVN. MUKTSAR	D5 S/D BARIWALA	8501FL06	SANGANA	AMR	OK	31.03.2023	31.03.2023	AP 3Phase 3Wire	9568192	900-450/577/1-1-1	1.988	NA	Director/D					
B.13028	West	MUKATSAR	11KV	D5 DIVN. MUKTSAR	D5 S/D BARIWALA	8501FL14	Jhabewali	AMR	OK	31.03.2023	31.03.2023	Category 5-UPS	10283015	900-450/577/1-1-1	4.883	NA	Director/D					
B.13029	West	MUKATSAR	11KV	D5 DIVN. MUKTSAR	D5 S/D BARIWALA	0511FL04	BAJA MARAR	AMR	OK	31.03.2023	31.03.2023	Category 1	9534452	900-450/577								

S.No	Zone	Circle	Voltage Level (kVA)	Division (kVA)	Sub-Division (kVA)	Feeder ID	Feeder Name	Feeder Metering Status (Metred/ unmetred/ AMR/AMI)	Status of Meter (Functional/Non-Functional)	Metering Date (Date of last actual meter reading/ communication)	Feeder Type (Agr/ Industrial/Mixed)	Status of Communication			Period from 01.04.2021 to 31.03.2022				Sales	Remarks (Source of data)
												% data received through automatically by feeder AMR/AMI	Number of hours when meter was unable to communicate in overall	Total Number of hours in the period	Meter S.No	CT/PT ratio	Import (MU)	Export (MU)		
B.13065	West	MUKATSAR	11KV	DS DIVN. MUKTSAR	DS S/D FATTANWALA	D526FL03	Gulabewala	NON AMR	OK	31.03.2023	AP 3Phase 3Wire				9534374	900-450/577/1-1-1	1.715	NA	Director/D	
B.13066	West	MUKATSAR	11KV	DS DIVN. MUKTSAR	DS S/D FATTANWALA	D526FL08	KHAPPANWALI AP NEW	NON AMR	OK	31.03.2023	AP 3Phase 3Wire				73132652	900-450/577/1-1-1	2.285	NA	Director/D	
B.13067	West	MUKATSAR	11KV	DS DIVN. MUKTSAR	DS S/D FATTANWALA	D526FL02	Lambi Dhad	NON AMR	OK	31.03.2023	Category 5-UPS				9534407	900-450/577/1-1-1	2.368	NA	Director/D	
B.13068	West	MUKATSAR	11KV	DS DIVN. MUKTSAR	DS S/D FATTANWALA	D526FL07	Isha Mehwar UPS	NON AMR	OK	31.03.2023	Category 5-UPS				33507	900-450/577/1-1-1	4.312	NA	Director/D	
B.13069	West	MUKATSAR	11KV	DS DIVN. MUKTSAR	DS S/D LUBANIWALI	B501FL13	Jali	AMR	OK	31.03.2023	Category 1				15194752	900-450/577/1-1-1	0.574	NA	Director/D	
B.13070	West	MUKATSAR	11KV	DS DIVN. MUKTSAR	DS S/D LUBANIWALI	D511FL02	BHDHIMAL	AMR	OK	31.03.2023	AP 3Phase 3Wire				9534609	900-450/577/1-1-1	2.052	NA	Director/D	
B.13071	West	MUKATSAR	11KV	DS DIVN. MUKTSAR	DS S/D LUBANIWALI	NEWFL01	MANGETKER	AMR	OK	31.03.2023	AP 3Phase 3Wire				9534555	900-450/577/1-1-1	1.245	NA	Director/D	
B.13072	West	MUKATSAR	11KV	DS DIVN. MUKTSAR	DS S/D LUBANIWALI	D501FL09	JASSE ANA	AMR	OK	31.03.2023	Category 5-UPS				8223022	900-450/577/1-1-1	0.000	NA	Director/D	
B.13073	West	MUKATSAR	11KV	DS DIVN. MUKTSAR	DS S/D LUBANIWALI	D501FL06	GREEN FIELD	AMR	OK	31.03.2023	Category 1				2068754	900-450/577/1-1-1	0.021	NA	Director/D	
B.13074	West	MUKATSAR	11KV	DS DIVN. MUKTSAR	DS S/D LUBANIWALI	D501FL05	LANDE RODE	AMR	OK	31.03.2023	AP 3Phase 3Wire				7336738	900-450/577/1-1-1	1.008	NA	Director/D	
B.13075	West	MUKATSAR	11KV	DS DIVN. MUKTSAR	DS S/D LUBANIWALI	D501FL17	Nizamae Kukrian	AMR	OK	31.03.2023	AP 3Phase 3Wire				4808	900-450/577/1-1-1	1.017	NA	Director/D	
B.13076	West	MUKATSAR	11KV	DS DIVN. MUKTSAR	DS S/D LUBANIWALI	D501FL14	SANGRANA AP	AMR	OK	31.03.2023	AP 3Phase 3Wire				15196534	900-450/577/1-1-1	1.022	NA	Director/D	
B.13077	West	MUKATSAR	11KV	DS DIVN. MUKTSAR	DS S/D LUBANIWALI	D501FL01	SERWALI	AMR	OK	31.03.2023	AP 3Phase 3Wire				777385	900-450/577/1-1-1	1.298	NA	Director/D	
B.13078	West	MUKATSAR	11KV	DS DIVN. MUKTSAR	DS S/D LUBANIWALI	D501FL04	BURA GUJAR	AMR	OK	31.03.2023	AP 3Phase 3Wire				7761883	900-450/577/1-1-1	1.408	NA	Director/D	
B.13079	West	MUKATSAR	11KV	DS DIVN. MUKTSAR	DS S/D LUBANIWALI	D501FL16	Randhawa	AMR	OK	31.03.2023	AP 3Phase 3Wire				777386	900-450/577/1-1-1	1.418	NA	Director/D	
B.13080	West	MUKATSAR	11KV	DS DIVN. MUKTSAR	DS S/D LUBANIWALI	D501FL07	BHANGEWALI	AMR	OK	31.03.2023	AP 3Phase 3Wire				11144511	900-450/577/1-1-1	1.506	NA	Director/D	
B.13081	West	MUKATSAR	11KV	DS DIVN. MUKTSAR	DS S/D LUBANIWALI	D501FL02	SAKANWALI	AMR	OK	31.03.2023	AP 3Phase 3Wire				6607703	900-450/577/1-1-1	1.725	NA	Director/D	
B.13082	West	MUKATSAR	11KV	DS DIVN. MUKTSAR	DS S/D LUBANIWALI	D501FL15	DOHAH AP	AMR	OK	31.03.2023	AP 3Phase 3Wire				15196583	900-450/577/1-1-1	1.740	NA	Director/D	
B.13083	West	MUKATSAR	11KV	DS DIVN. MUKTSAR	DS S/D LUBANIWALI	D501FL03	KANIANWALI	AMR	OK	31.03.2023	AP 3Phase 3Wire				2046675	900-450/577/1-1-1	1.886	NA	Director/D	
B.13084	West	MUKATSAR	11KV	DS DIVN. MUKTSAR	DS S/D LUBANIWALI	D501FL08	NOOR PUR KIRPAL KE	AMR	OK	31.03.2023	AP 3Phase 3Wire				777398	900-450/577/1-1-1	2.023	NA	Director/D	
B.13085	West	MUKATSAR	11KV	DS DIVN. MUKTSAR	DS S/D LUBANIWALI	D501FL10	Sakkanweli	NON AMR	OK	31.03.2023	Category 5-UPS				2055843	900-450/577/1-1-1	5.311	NA	Director/D	
B.13086	West	MUKATSAR	11KV	DS DIVN. MUKTSAR	DS S/D LUBANIWALI	D501FL13	Sherwali UPS	AMR	OK	31.03.2023	Category 5-UPS				23679	900-450/577/1-1-1	6.874	NA	Director/D	
B.13087	West	MUKATSAR	11KV	DS DIVN. MUKTSAR	DS S/D LUBANIWALI	D501FL12	Kanianwali UPS	AMR	OK	31.03.2023	Category 5-UPS				34217	900-450/577/1-1-1	7.006	NA	Director/D	
B.13088	West	MUKATSAR	11KV	DS DIVN. MUKTSAR	DS S/D LUBANIWALI	DM11FL02	11 KV Jagat Singhwala	AMR	OK	31.03.2023	AP 3Phase 3Wire				198010	Not installed	1.294	NA	Director/D	
B.13089	West	MUKATSAR	11KV	DS DIVN. MUKTSAR	DS S/D LUBANIWALI	DM11FL03	11 KV Mukand Singh Wala AP	AMR	OK	31.03.2023	AP 3Phase 3Wire				197989	Not installed	1.796	NA	Director/D	
B.13090	West	MUKATSAR	11KV	DS DIVN. MUKTSAR	DS S/D LUBANIWALI	DM11FL01	11 KV Kanawali	Not available	OK	31.03.2023	Category 4				197973	Not installed	6.222	NA	Director/D	
B.13091	West	MUKATSAR	66KV	DS DIVN. MUKTSAR	DS S/D LUBANIWALI	D501D13	Satia Synthetics Mill	AMR	OK	31.03.2023	Category 4				Not available	Not available	25.992	NA	Director/D	
B.13092	West	MUKATSAR	11KV	DS DIVN. MUKTSAR	DS S/D RUPANA	D532FL08	Khunde Halal	AMR	OK	31.03.2023	AP 3Phase 3Wire				777494	900-450/577/1-1-1	0.463	NA	Director/D	
B.13093	West	MUKATSAR	11KV	DS DIVN. MUKTSAR	DS S/D RUPANA	D532FL01	CHIBRANWALI AP	AMR	OK	31.03.2023	AP 3Phase 3Wire				11116730	900-450/577/1-1-1	1.718	NA	Director/D	
B.13094	West	MUKATSAR	11KV	DS DIVN. MUKTSAR	DS S/D RUPANA	D532FL06	Nanakpura UPS	AMR	OK	31.03.2023	Category 5-UPS				8222655	900-450/577/1-1-1	5.911	NA	Director/D	
B.13095	West	MUKATSAR	11KV	DS DIVN. MUKTSAR	DS S/D RUPANA	D532FL02	DUBEHWALA AP	AMR	OK	31.03.2023	AP 3Phase 3Wire				777539	900-450/577/1-1-1	0.652	NA	Director/D	
B.13096	West	MUKATSAR	11KV	DS DIVN. MUKTSAR	DS S/D RUPANA	D532FL07	Phodewala AP	AMR	OK	31.03.2023	AP 3Phase 3Wire				956280	900-450/577/1-1-1	1.389	NA	Director/D	
B.13097	West	MUKATSAR	11KV	DS DIVN. MUKTSAR	DS S/D RUPANA	D532FL06	ghulle wala ups	AMR	OK	31.03.2023	Category 5-UPS				10283039	900-450/577/1-1-1	3.056	NA	Director/D	
B.13098	West	MUKATSAR	11KV	DS DIVN. MUKTSAR	DS S/D RUPANA	D547FL03	Bhangchari AP	AMR	OK	31.03.2023	AP 3Phase 3Wire				73196307	900-450/577/1-1-1	0.446	NA	Director/D	
B.13099	West	MUKATSAR	11KV	DS DIVN. MUKTSAR	DS S/D RUPANA	D547FL03	Dabra AP	AMR	OK	31.03.2023	AP 3Phase 3Wire				777532	900-450/577/1-1-1	0.894	NA	Director/D	
B.13100	West	MUKATSAR	11KV	DS DIVN. MUKTSAR	DS S/D RUPANA	D547FL04	METHRAWALA AP	AMR	OK	31.03.2023	AP 3Phase 3Wire				11117151	900-450/577/1-1-1	1.417	NA	Director/D	
B.13101	West	MUKATSAR	11KV	DS DIVN. MUKTSAR	DS S/D RUPANA	D547FL02	PHULEWALA CAT-1	AMR	OK	31.03.2023	Category 4				11116728	900-450/577/1-1-1	2.245	NA	Director/D	
B.13102	West	MUKATSAR	11KV	DS DIVN. MUKTSAR	DS S/D RUPANA	D547FL01	TANKOT UPS	AMR	OK	31.03.2023	Category 5-UPS				11116731	900-450/577/1-1-1	3.485	NA	Director/D	
B.13103	West	MUKATSAR	11KV	DS DIVN. MUKTSAR	DS S/D RUPANA	D503FL07	460 KV Goneana	AMR	OK	31.03.2023	Category 2				12527353	1200-600/577/1-1-1	0.302	NA	Director/D	
B.13104	West	MUKATSAR	11KV	DS DIVN. MUKTSAR	DS S/D RUPANA	D503FL02	BARKANDI AP	AMR	OK	31.03.2023	AP 3Phase 3Wire				2047101	1200-600/577/1-1-1	1.128	NA	Director/D	
B.13105	West	MUKATSAR	11KV	DS DIVN. MUKTSAR	DS S/D RUPANA	D503FL01	DHIGANA AP	AMR	OK	31.03.2023	AP 3Phase 3Wire				4187876	1200-600/577/1-1-1	1.357	NA	Director/D	
B.13106	West	MUKATSAR	11KV	DS DIVN. MUKTSAR	DS S/D RUPANA	D503FL08	11.1 KV Goneana	AMR	OK	31.03.2023	AP 3Phase 3Wire				8223021	1200-600/577/1-1-1	1.373	NA	Director/D	
B.13107	West	MUKATSAR	11KV	DS DIVN. MUKTSAR	DS S/D RUPANA	D503FL04	ROTHA AP	AMR	OK	31.03.2023	AP 3Phase 3Wire				2995269	1200-600/577/1-1-1	1.687	NA	Director/D	
B.13108	West	MUKATSAR	11KV	DS DIVN. MUKTSAR	DS S/D RUPANA	D503FL03	GLOBAL ENV. AP	AMR	OK	31.03.2023	AP 3Phase 3Wire				2068285	1200-600/577/1-1-1	1.768	NA	Director/D	
B.13109	West	MUKATSAR	11KV	DS DIVN. MUKTSAR	DS S/D RUPANA	D503FL09	Tibbi UPS	AMR	OK	31.03.2023	Category 5-UPS				2763	1200-600/577/1-1-1	3.187	NA	Director/D	
B.13110	West	MUKATSAR	11KV	DS DIVN. MUKTSAR	DS S/D RUPANA	D503FL10	Check Dhewala ups	AMR	OK	31.03.2023	Category 5-UPS				3516	1200-600/577/1-1-1	3.191	NA	Director/D	
B.13111	West	MUKATSAR	11KV	DS DIVN. MUKTSAR	DS S/D RUPANA	D509FL05	RUPANA UPS	AMR	OK	31.03.2023	Category 5-UPS				822298	1200-600/577/1-1-1	7.677	NA	Director/D	
B.13112	West	MUKATSAR	11KV	DS DIVN. MUKTSAR	DS S/D RUPANA	D509FL06	Bhangchari UPS	AMR	OK	31.03.2023	Category 5-UPS				2066028	1200-600/577/1-1-1	9.024	NA	Director/D	
B.13113	West	MUKATSAR	66KV	DS DIVN. MUKTSAR	DS S/D RUPANA	D503D01	Satia Paper Mill (Rupana)	Not available	OK	31.03.2023	Category 4				Not available	Not available	6.263	NA	Director/D	
B.13114	West	MUKATSAR	11KV	DS DIVN. MUKTSAR	DS S/U S/D MUKTSAR	C501FL05	SANGU DHUAN	AMR	OK	31.03.2023	AP 3Phase 3Wire				9568244	900-450/577/1-1-1	0.988	NA	Director/D	
B.13115	West	MUKATSAR	11KV	DS DIVN. MUKTSAR	DS S/U S/D MUKTSAR	C501FL01	THANDEWALA ap	AMR	OK	31.03.2023	AP 3Phase 3Wire				9154099	1200-600/577/1-1-1	1.779	NA	Director/D	
B.13116	West	MUKATSAR	11KV	DS DIVN. MUKTSAR	DS S/U S/D MUKTSAR	C501FL04	TIBBI SAHIB	AMR	OK	31.03.2023	Category 1				9154098	1200-600/577/1-1-1	4.072	NA	Director/D	
B.13117	West	MUKATSAR	11KV	DS DIVN. MUKTSAR	DS S/U S/D MUKTSAR	C501FL07	THANDEWALA	AMR	OK	31.03.2023	Category 5-UPS				9568279	900-450/577/1-1-1	9.599	NA	Director/D	
B.13118	West	MUKATSAR	11KV	DS DIVN. MUKTSAR	DS S/U S/D MUKTSAR	C501FL02	INDUSTRIAL	AMR	OK	31.03.2023	Category 1				9568280	900-450/577/1-1-1	13.022	NA	Director/D	
B.13119	West	MUKATSAR	11KV	DS DIVN. MUKTSAR	DS S/U S/D MUKTSAR	B501FL08	DIPOSAL BY-PASS	AMR	OK	31.03.2023	Category 2				9568105	900-450/577/1-1-1	0.048	NA	Director/D	
B.13120	West	MUKATSAR	11KV	DS DIVN. MUKTSAR	DS S/U S/D MUKTSAR	B501FL10	JALALABAD ROAD	AMR	OK	31.03.2023	Category 1				7030204	900-450/577/1-1-1	6.250	NA	Director/D	
B.13121	West	MUKATSAR	11KV	DS DIVN. MUKTSAR	DS S/U S/D MUKTSAR	B501FL05	FOCAL POINT	AMR	OK	31.03.2023	Category 2				9568129	900-450/577/1-1-1	9.661	NA	Director/D	
B.13122	West	MUKATSAR	11KV	DS DIVN. MUKTSAR	DS S/U S/D MUKTSAR	D525FL01	Kothe Dal Singh(Thandewala)	NON AMR	OK	31.03.2023	AP 3Phase 3Wire				9154493	900-450/577/1-1-1	1.605	NA	Director/D	
B.13123	West	MUKATSAR	11KV	DS DIVN. MUKTSAR	DS S/U S/D MUKTSAR	D526FL05	11KV Diaposal	AMR	OK	31.03.2023	Category 1				2281	1200/577/1-1-1	0.146	NA	Director/D	
B.13124	West	MUKATSAR	11KV	DS DIVN. MUKTSAR	DS S/U S/D MUKTSAR	D526FL06	11KV Muktsar AP	NON AMR	OK	31.03.2023	AP 3Phase 3Wire				73151445	1200/577/1-1-1	1.673	NA	Director/D	
B.13125	West	MUKATSAR	11KV	DS DIVN. MUKTSAR	DS S/U S/D MUKTSAR	D569FL04	11KV Fattanwala Road	NON AMR	OK	31.03.2023	Category 1				16194455	1200/577/1-1-1	5.985	NA	Director/D	
B.13126	West	MUKATSAR	11KV	DS DIVN. MUKTSAR	DS S/U S/D MUKTSAR	D569FL01	11KV Gausahala Road	NON AMR	OK	31.03.2023	Category 1				16194452	1200/577/1-1-1	6.590	NA	Director/D	
B.13127	West	MUKATSAR	11KV	DS DIVN. MUKTSAR	DS S/U S/D MUKTSAR	D569FL02	11KV Old Grain Market.	NON AMR	OK	31.03.2023	Category 1				2285	1200/577/1-1-1	7.733	NA	Director/D	
B.131																				

S.No	Zone	Circle	Voltage Level (KVA)	Division (KVA)	Sub-Division (KVA)	Feeder ID	Feeder Name	Feeder Metering Status (Metered/ un-metered/ AMI/ANIR)	Status of Meter (Functional/Non-functional)	Metering Date Date of last actual meter reading/ communication	Feeder Type (Agri/ Industrial/Mixed)	Status of Communication			Period from 01.04.2021 to 31.03.2022				Sales	Remarks (Source of data)
												% data received through automatically if feeder AMR/AMI	Number of hours when meter was unable to communicate in period	Total Number of hours in the period	Meter S.No	CT/PT ratio	Import (MU)	Export (MU)		

I/We undertake that the information supplied in this Document and Pro-forma is accurate to the best of my knowledge and if any of the information supplied is found to be incorrect and such information result into loss to the Central Government or State Government or any of the authority under them or any other person affected, I/we undertake to indemnify such loss.

Authorised Signatory and Seal

Name of Authorised Signatory
Name of the DISCOM:
Full Address:-

Seal

Signature:-
Name of Energy Manager*:
Registration Number:

Details of Input Energy Sources								
Period From 01.04.2022 To 31.03.2023								
A. Generation at Transmission Periphery (Details)								
S.No.	Name of Generation Station	Generation Capacity (In MW)	Type of Station Generation (Based- Solid / Coal /Lignite/ Liquid/Gas/ Renewable (biomass- bagasse) Others)	Type of Contract (in years/months/days)	Type of Grid (Intra- state/Inter- state)	Point of Connection (POC) Loss MU	Voltage Level At input	Remarks (Source of data)
A	ij Solar (Intrastate)					Net Energy Supplied (Mus)		
1	Abundant Energy Pvt. Ltd. Plant-I	2	Solar (Intrastate)	Long Term	66 KV S/Stn. Narlai	2.794	11	ISB
2	Abundant Energy Pvt. Ltd. Plant-II	1	Solar (Intrastate)	Long Term	66 KV S/Stn. Narlai	1.352	11	ISB
3	Acme Solar Rooftop system pvt. Ltd. Jhunir	15	Solar (Intrastate)	Long Term	66KV S/Stn. Danewala	21.375	66	ISB
4	Acme Solar Rooftop system pvt. Ltd. Nangla,Talwandi Sahib	15	Solar (Intrastate)	Long Term	66 KV S/Stn. Nangla	21.695	66	ISB
5	Aditya Medisales Ltd., Lalpur, Hoshiarpur	4	Solar (Intrastate)	Long Term	66 KV Janauri	5.420	66	ISB
6	Allianz Ecopower Pvt. Ltd., Boparai Kalan, Ludhiana	2	Solar (Intrastate)	Long Term	66 KV S/Stn. Alike	2.669	11	ISB
7	Aster Solar Power Pvt. Ltd., Jhunir, Mansa	1	Solar (Intrastate)	Long Term	220 KV S/Stn. Jhunir	1.473	11	ISB
8	Alma Powers Pvt. Ltd., Lakhewali, Mukatsar	2	Solar (Intrastate)	Long Term	66 KV S/s Lakhewali	2.790	11	ISB
9	Azure Power Makemake Pvt. Ltd., Bhattiwala	4	Solar (Intrastate)	Long Term	66 KV S/Stn. Bhattiwala	5.824	66	ISB
10	Azure Power Makemake Pvt. Ltd., Killianwali	24	Solar (Intrastate)	Long Term	66 KV S/Stn. Killianwali	37.088	66	ISB
11	Azure Power Pluto Pvt. Ltd.,Bahadurgarh Jandia-1	25	Solar (Intrastate)	Long Term	66 KV Peori	37.719	66	ISB
12	Azure Power Pluto Pvt. Ltd.,Bahadurgarh Jandia-2	25	Solar (Intrastate)	Long Term	66 KV Tharajwala	38.011	66	ISB
13	Azure Power Pluto Pvt. Ltd.,Korianwali	25	Solar (Intrastate)	Long Term	66 KV Bamwala Hanuwanta	37.068	66	ISB
14	Azure Power Pluto Pvt. Ltd.,Badal	15	Solar (Intrastate)	Long Term	132 KV Badal	23.351	66	ISB
15	Azure Power Pluto Pvt. Ltd.,Bahadurkhera	25	Solar (Intrastate)	Long Term	66 KV Malookpura	38.339	66	ISB
16	Azure Power Pluto Pvt. Ltd.,Bhattiwala	10	Solar (Intrastate)	Long Term	66 KV Bhattiwala	15.523	66	ISB
17	Azure Power Pluto Pvt. Ltd.,Vamwala	25	Solar (Intrastate)	Long Term	66 KV Vamwala Anuka	37.653	66	ISB
18	Azure Renewable Energy Pvt. Ltd., PSAMB, Mansa	0.63	Solar (Intrastate)	Long Term	66 KV Anaj Mandi Mansa	0.558	11	ISB
19	Azure Renewable Energy Pvt. Ltd., Bhagwant singh & Kulwinder kaur, Kolla Fazal	0.55	Solar (Intrastate)	Long Term	66 KV Atterwali	0.000	11	ISB
20	Azure Renewable Energy Pvt. Ltd., Anil Singla Warehouse, Mukatsar	0.801	Solar (Intrastate)	Long Term	66 KV Atterwali	0.000	11	ISB
21	Azure Renewable Energy Pvt. Ltd., Vikas Singla Warehouse, Jodhpur Ramana, Bathinda	0.503	Solar (Intrastate)	Long Term	66 KV Badali Ala Singh	0.000	11	ISB
22	Azure Renewable Energy Pvt. Ltd., Boss Computers Ltd. Zirakpur	1.25	Solar (Intrastate)	Long Term	66 KV Bhabat	0.000	11	ISB
23	Azure Renewable Energy Pvt. Ltd., CA Veg Fruits, Kharar	0.599	Solar (Intrastate)	Long Term	66 KV Gharuan	0.591	11	ISB
24	Azure Renewable Energy Pvt. Ltd., Canam Cons.Morinda	1.60	Solar (Intrastate)	Long Term	66 KV Hargana	1.144	11	ISB
25	Azure Renewable Energy Pvt. Ltd., PSAMB, Ludhiana	0.76	Solar (Intrastate)	Long Term	66 KV Nurewal	0.472	11	ISB
26	Azure Renewable Energy Pvt. Ltd.s, PSAMB, Mohali	2.05	Solar (Intrastate)	Long Term	66 KV. Ph. 9, Indl. Area, Distt.SAS Nager	1.311	11	ISB
27	Azure Renewable Energy Pvt. Ltd., Skyrose,sangrur	1.26	Solar (Intrastate)	Long Term	66 KV Nadampur	1.199	11	ISB
28	Azure Urja Pvt. Ltd. , 15 MW (Tahliwal jattan), Project-I	15	Solar (Intrastate)	Long Term	66 KV Arniwala	19.564	66	ISB
29	Azure Urja Pvt. Ltd. , 15 MW (Sikhwala / Punjwa), Project-II	15	Solar (Intrastate)	Long Term	66 KV Sikhwala	20.413	66	ISB
30	Azure Urja Pvt. Ltd. , 4 MW (Sikhwala / Punjwa), Project-III	4	Solar (Intrastate)	Long Term	66 KV Sikhwala	5.542	66	ISB
31	Bhanuenergy Industrial Development Ltd. (BIDL)	15	Solar (Intrastate)	Long Term	66 KV Alike	21.996	66	ISB
32	Bhanuenergy Infrastructure Pvt. Ltd. (BIPL)	15	Solar (Intrastate)	Long Term	66 KV Alike	22.095	66	ISB
33	Canal Solar Energy Pvt. Ltd.	7.5	Solar (Intrastate)	Long Term	66KV Allowal	7.695	66	ISB
34	Carilli Energy Pvt. Ltd. , Bhagsar, Mukatsar	1.5	Solar (Intrastate)	Long Term	66 KV S/s Bhagsar	1.857	11	ISB

35	Continental Engineering & Power Pvt. Ltd.	1	Solar (Intrastate)	Long Term	66 KV Kot shamir	1.417	11	ISB
36	Earth Solar Pvt. Ltd., Behalpur, Nabha	4	Solar (Intrastate)	Long Term	66 KV S/Stn. Bhadson	4.755	66	ISB
37	Enterprise Business Solutions Pvt. Ltd., Sahiba -Shadhra, SBS Nagar	1.5	Solar (Intrastate)	Long Term	66KV S/Stn. Karawar	1.093	11	ISB
38	Ecoenergy Inc., Boparai kalan, Ludhiana	1	Solar (Intrastate)	Long Term	66KV S/Stn. Sudhar	0.960	11	ISB
39	Focal Energy Solar India Pvt. Ltd., Nangla, Bathinda	4	Solar (Intrastate)	Long Term	66 KV S/Stn. Nangla	6.073	66	ISB
40	G.S.Atwal & Co (Engineers) Pvt. Ltd., Bhuttiwal Mukatsar	1.5	Solar (Intrastate)	Long Term	66KV S/Stn. Bhuttiwala	1.570	11	ISB
41	IK Energy Pvt. Ltd. Lallian Kalan, Jalandhar	1	Solar (Intrastate)	Long Term	66 KV Chitti	1.094	11	ISB
42	International Switchgears Pvt. Ltd. Ph-I, Ramdas, Amritsar	1	Solar (Intrastate)	Long Term	66 KV S/Stn. Ramdas	0.917	11	ISB
43	International Switchgears Pvt. Ltd. Ph-II, Ramdas, Amritsar	1	Solar (Intrastate)	Long Term	66 KV S/Stn. Ramdas	1.074	11	ISB
44	JSSK Energy Pvt. Ltd.	1	Solar (Intrastate)	Long Term	66 KV S/Stn. Bhagsar	1.402	11	ISB
45	Madhav Solar Pvt. Ltd-I, Boha, Mansa	2	Solar (Intrastate)	Long Term	66 KV S/Stn. Boha	2.620	11	ISB
46	Madhav Solar Pvt. Ltd-II, Boha, mansa	2	Solar (Intrastate)	Long Term	66 KV S/Stn. Boha	3.026	11	ISB
47	Magnet Buildtech Pvt. Ltd -I, Sherkawala	25	Solar (Intrastate)	Long Term	66 KV Boha	36.056	66	ISB
48	Magnet Buildtech Pvt. Ltd-II, Toderpur	25	Solar (Intrastate)	Long Term	66 KV Boha	36.904	66	ISB
49	Magnificent Power Pvt. Ltd.	1	Solar (Intrastate)	Long Term	220 KV S/S Jhunir	1.380	11	ISB
50	Mihit Solar Power Pvt. Ltd., Jhandakalan	24	Solar (Intrastate)	Long Term	66 KV Sardulgarh	35.920	66	ISB
51	Mihit Solar Power Pvt. Ltd., Khera khurad	25	Solar (Intrastate)	Long Term	66 KV S/Stn. Sardulgarh	38.004	66	ISB
52	Mihit Solar Power Pvt. Ltd., Mankhera	25	Solar (Intrastate)	Long Term	66 KV S/Stn. Sangha	38.815	66	ISB
53	Mokia Green Energy Pvt. Ltd., Boparai Kalan, Ludhiana	4	Solar (Intrastate)	Long Term	66 KV S/Stn. Boha	5.634	66	ISB
54	Mytrah Aadhya Power Pvt. Ltd.-Balran	25	Solar (Intrastate)	Long Term	66 KV S/Stn. Balran	40.044	66	ISB
55	Mytrah Aadhya Power Pvt. Ltd.-Bareta	25	Solar (Intrastate)	Long Term	66 KV Datewas	38.430	66	ISB
56	Nextgen Solux Power Pvt. Ltd., Mitpurkalan, Mansa-I	1	Solar (Intrastate)	Long Term	66KV Alike	1.477	11	ISB
57	Nextgen Solux Power Pvt. Ltd., Jhunir, Mansa-II	1	Solar (Intrastate)	Long Term	220 KV Jhunir	1.468	11	ISB
58	Northstar Solar Power Pvt. Ltd., Pathraia, Bathinda	4	Solar (Intrastate)	Long Term	66KV Pathraia	6.037	66	ISB
59	Oasis Green Pvt. Ltd.	3	Solar (Intrastate)	Long Term	66 KV S/Stn. Bareta	4.257	66	ISB
60	Omega infraengineers Pvt. Ltd.	1	Solar (Intrastate)	Long Term	66 KV S/Stn. Chaurwala	1.232	11	ISB
61	Omega Solar Projects Pvt. Ltd., Sangatpur, Lehragara	10	Solar (Intrastate)	Long Term	66KV Ganduan	14.088	66	ISB
62	Phulokheri PEDASPV	1	Solar (Intrastate)	Long Term	66KV Rama Mandi	1.073	11	ISB
63	Photon Sunbeam Pvt. Ltd-I	15	Solar (Intrastate)	Long Term	66 KV S/Stn. Ramamandi	20.851	66	ISB
64	Photon Sunbeam Pvt. Ltd-II	25	Solar (Intrastate)	Long Term	220 KV S/Stn. Talwandi Sabo	32.342	66	ISB
65	PN Clean Energy Ltd., Lakhtmirwala, Mansa	20	Solar (Intrastate)	Long Term	66 KV S/Stn. Kot Dharmu	29.436	66	ISB
66	PN Renewable Energy Ltd. Barre, Mansa	10	Solar (Intrastate)	Long Term	66 KV S/Stn. Tahillyan, Boha	14.544	66	ISB
67	Prayatna Developers Pvt. Ltd.-I, Sardargarh	50	Solar (Intrastate)	Long Term	132 KV S/Stn. Balluana	82.439	132	ISB
68	Prayatna Developers Pvt. Ltd.-II Chughekalan	50	Solar (Intrastate)	Long Term	132 KV S/Stn. Balluana	82.708	132	ISB

69	Purshotam Industries Ltd., Vill. Bajak, Bathinda	3	Solar (Intrastate)	Long Term	66 KV S/Stn. Nandgarh	4.321	66	ISB
70	Radiant Solar Energies Pvt. Ltd.	3	Solar (Intrastate)	Long Term	66 KV S/Stn. Pathrala	4.504	66	ISB
71	RSSB Educational & Environmental Society, Beas (New)	12	Solar (Intrastate)	Long Term	132KV S/Stn. Beas	15.275	132	ISB
72	RSSB Educational & Environmental Society, Beas (Old)	7.52	Solar (Intrastate)	Long Term	132KV Beas	8.629	132	ISB
73	SAM SOLAR Pvt. Ltd. Doraha, Canal top	2.5	Solar (Intrastate)	Long Term	66 KV S/Stn. Doburji	3.014	11	ISB
74	SAM SOLAR Pvt. Ltd. Nidampur, Sangrur	2.5	Solar (Intrastate)	Long Term	66 KV S/Stn. Nidampur	2.230	11	ISB
75	Solairdirect Projects India Pvt. Ltd., Dharangwala, Fazilka	20	Solar (Intrastate)	Long Term	66 KV S/Stn. Ratta Tibba	30.334	66	ISB
76	Solaire Power Pvt. Ltd. Usmankhara	24	Solar (Intrastate)	Long Term	66 KV S/Stn. Kaller Khera	37.479	66	ISB
77	Solaire Urja Pvt Ltd.	25	Solar (Intrastate)	Long Term	66 KV S/Stn. Khuian Sarwar	34.506	66	ISB
78	Soma Enterprises Ltd., Khera Kalmout	1	Solar (Intrastate)	Long Term	66KV Nangal	0.875	11	ISB
79	Sovox Renewables Pvt. Ltd., Mehandipur	1	Solar (Intrastate)	Long Term	66KV S/Stn. Kathgarh, Tehsil Balachaur	0.672	11	ISB
80	T R Energy & Agro Pvt. Ltd., Jandwala Mirsanga, Fazilka	2	Solar (Intrastate)	Long Term	66 KV Kheowali Ghab	2.893	11	ISB
81	T R Energy & Agro Pvt. Ltd., Vill. Pathrala, Fazilka II	1	Solar (Intrastate)	Long Term	66 KV Pathrala	1.626	11	ISB
82	Vector Green Sunshine Pvt. Ltd., Gamiwala Boha	20	Solar (Intrastate)	Long Term	66 KV S/Stn. Gamiwala, Boha	29.568	66	ISB
83	Vector Green Surya Urja Pvt. Ltd., Gamiwala, Boha, Mansa	20	Solar (Intrastate)	Long Term	66 KV S/Stn. Gamiwala, Boha	30.804	66	ISB
84	Vijay Printing Press Pvt. Ltd., Ghager branch canal (Rooftop)	7.5	Solar (Intrastate)	Long Term	66KV Bhattiwal	9.316	66	ISB
85	Vivaan Solar Pvt. Ltd., Bajak Bathinda	2	Solar (Intrastate)	Long Term	66 KV S/Stn. Nandgarh	2.923	11	ISB
86	Walwhan Solar Punjab Ltd.-I, Tiona pujarian,	20	Solar (Intrastate)	Long Term	66 KV S/Stn. Jaga Ram Tirath	27.514	66	ISB
87	Walwhan Solar Punjab Ltd.-II, Jagaram Tirath,	10	Solar (Intrastate)	Long Term	66 KV S/Stn. Jaga Ram Tirath	13.766	66	ISB
88	Walwhan Solar Punjab Ltd.-III, Jagaram Tirath	2	Solar (Intrastate)	Long Term	66 KV S/Stn. Jaga Ram Tirath	2.701	11	ISB
89	Walwhan Solar Punjab Ltd.- IV, Tiona pujarian,	4	Solar (Intrastate)	Long Term	66 KV S/Stn. Jaga Ram Tirath	5.359	66	ISB
i) Total Solar (Intrastate)		884.02				1292.026		ISB
ii) Solar (Interstate)								
1	Bundled NVNL (solar only)	37	Solar (Interstate)	Long Term	Outside Punjab	52.482		
2	SECI Solar	30	Solar (Interstate)	Long Term	Outside Punjab	55.819		
Total ii)		67.00				108.302		
Total Solar (i+ ii)		951.02				1400.328		
B Co Generation								
a Bagasse (Co-gen)								
1	A.B. Sugars Ltd	23	Bagasse (Co-gen)	Long Term	66 KV Sethala	69.820	66	ISB
2	Chadha Sugars & Ind. Ltd.	23	Bagasse (Co-gen)	Long Term	66 KV SS, Rojao	57.896	66	ISB
3	Indian Sucrose Ltd	40	Bagasse (Co-gen)	Long Term	132 KV Uchi Basi	25.961	66	ISB
4	Nawanshahar Power Pvt. Ltd.	15	Bagasse (Co-gen)	Long Term	132 KV Nawanshahar	17.772	66	ISB
5	Rana Sugars Ltd (3MMW)	34	Bagasse (Co-gen)	Long Term	66 KV Sethala	33.045	66	ISB
6	Wahid Sandhar Sugars Ltd.	12	Bagasse (Co-gen)	Long Term	66 KV SS Phagwara	10.392	33	ISB

c	Kotla Hydro Ltd								ISB
1	Babanpur MHP	1.25	Mini Hydel	Long Term	66 KV Dhuri	5.081	11		ISB
2	Killa	1.75	Mini Hydel	Long Term	66 KV Rangian	9.250	11		ISB
3	Sahoke	1.2	Mini Hydel	Long Term	66 KV Ashpal Kalan	6.300	11		ISB
	Kotla Hydro Ltd.Total	4.2				20.631			ISB
d	Punjab Hydro Ltd.								ISB
	Dolowal MHP	0	Mini Hydel	Long Term	66 KV S/Stn. Lassoi	4.995	11		ISB
2	Salar MHP	0	Mini Hydel	Long Term	66 KV S/Stn. Amargah	5.198	11		ISB
3	Bhanubura MHP	0	Mini Hydel	Long Term	66 KV S/Stn. Bhanubhura	5.623	11		ISB
	Punjab Hydro Ltd. Total.	0				15.815			ISB
e	Individual hydel Plant								ISB
1	Allantic Power Pvt. Ltd.(Phoola)	0.60	Mini Hydel	Long Term	66 KV Nathana	2.281	11		ISB
2	Allantic Power Pvt. Ltd. (Nakkian)	0.30	Mini Hydel	Long Term	132 KV Nakkian	1.261	11		ISB
3	Allantic Power Pvt. Ltd. (Terkiana)	0.65	Mini Hydel	Long Term	66 KV Bhattiyan	3.149	11		ISB
4	Allantic Power Pvt. Ltd. (Terkiana) PSPCL Free energy share	0.00	Mini Hydel	Long Term		1.350	11		ISB
5	Gill Aqua Hydro Power Generation Co. Pvt. Ltd. -MBL-II	6.00	Mini Hydel	Long Term	66 KV S/Stn. Ranipur	12.578	66		ISB
6	Gill Aqua Hydro Power Generation Co. Pvt. Ltd. -MBL-III	3.80	Mini Hydel	Long Term	66 KV S/Stn. Ranipur	7.130	66		ISB
f	Gill Power Geneation Co. (P) Ltd.	2.70	Mini Hydel	Long Term	220 KV S/Stn.Tibbar	8.056	11		ISB
8	Himalayan Renewable Energy Pvt. Ltd.	0.60	Mini Hydel	Long Term	66 KV S/Stn. Tallewal	4.008	11		ISB
9	Kotla Renewables Pvt. Ltd. Daudhar	1.50	Mini Hydel	Long Term	220 KV S/Stn. Badhani Kalan	4.494	11		ISB
10	Kotla Renewables Pvt. Ltd. Nidampur	0.80	Mini Hydel	Long Term	66 KV S/Stn. Nidampur	1.429	11		ISB
11	Kotla Renewables Pvt. Ltd. Thuhi	0.80	Mini Hydel	Long Term	66 KV S/Stn. Bharo	2.075	11		ISB
12	Majha Canal Hydro Project Pvt.Ltd.Udhanwal	0.65	Mini Hydel	Long Term	66 KV S/Stn. Udhanwal	0.658	11		ISB
13	P & R Gurditiwala Hydro Power Pvt. Ltd.	2.00	Mini Hydel	Long Term	66 KV Mallanwala	8.553	11		ISB
14	Preetek Power Pvt. Ltd. (Tugalwal)	0.85	Mini Hydel	Long Term	66 KV Harchowal	1.282	11		ISB
15	Sam India Hydro Power Pvt. Ltd.	1.20	Mini Hydel	Long Term	132 KV S/Stn. Bilaspur	3.424	11		ISB
16	Sidhwan Hydro Power Pvt. Ltd.	0.70	Mini Hydel	Long Term	66 KV Modeltown, Ext.Ludhiana	1.964	11		ISB
17	SKR Hydro Power Generators Pvt. Ltd.	0.40	Mini Hydel	Long Term	66 KV S/Stn.MES Bathinda	0.873	11		ISB
18	UBDC Hydro Company	2.00	Mini Hydel	Long Term	66 KV S/Stn Ror Khera Bhagowal	8.233	11		ISB
19	Preetek Power Pvt. Ltd. (Kalabal)	0.80	Mini Hydel	Long Term	0	1.246	11		ISB
20	Hydro Energy & Infrastructure	0.25	Mini Hydel	Long Term	66KV S/STN. Dhadrian	0.979	11		ISB
21	Salasar Hydro Urja Pvt. Ltd.	1.50	Mini Hydel	Long Term	Lohgarh Thakran	11.495	11		ISB
	Individual Hydel Total	28.10				86.518			ISB
f	Punjab Genco Ltd.								ISB
1	Narangwal MHP	1.50	Mini Hydel	Long Term	66 KV Narangwal	4.528	11		ISB
2	Dalla MHP	1.00	Mini Hydel	Long Term	66 KV Rumi	2.958	11		ISB
3	Tugal MHP	1.50	Mini Hydel	Long Term	66 KV Sudhar	4.614	11		ISB
4	Chupki MHP	1.50	Mini Hydel	Long Term	66 KV Alamgir	5.118	11		ISB
5	Khatra MHP	1.00	Mini Hydel	Long Term	66 KV Siar	2.208	11		ISB

01.04.2022 To 31.03.2023																				
(Details of Feeder-wise losses)																				
Sl No.	Zone	Circle	Received at Circle (In MU)	Division	Received at Division (In MU)	Subdivision	Received at Sub Division (In MU)	Name of the Station	Feeder Code/ID	Feeder Name	Type of Feeder (Urban/Mixed/Industrial/Agriculture/Village)	Type of Feeder (AMR/AMM/Other)	Received at Feeder (Final in MU)	Feeder Consumption (in MU)	Final Net Export at Feeder Level (in MU)	T&D losses	AT&C losses	% Data Received through Automatically (If Feeder AMR/AMM)	Remarks	
1	Border	CITY AMRITSAR		DS CITY CENTER DIVN.,_ASR		DS S/D GHEE MANDI TECH.,_ASR			C753F03	11kv NEW GOLDEN AVENUE	Category 1	AMR	5.220						Feeder wise T&D and AT&C losses are not available currently	
2	Border	CITY AMRITSAR		DS CITY CENTER DIVN.,_ASR		DS S/D GHEE MANDI TECH.,_ASR			C754F01	HUSSAINPURA	Category 1	AMR	7.634							
3	Border	CITY AMRITSAR		DS CITY CENTER DIVN.,_ASR		DS S/D GHEE MANDI TECH.,_ASR			C751F02	Head Water Works Road	Category 1	AMR	8.306							
4	Border	CITY AMRITSAR		DS CITY CENTER DIVN.,_ASR		DS S/D GHEE MANDI TECH.,_ASR			C753F08	11kv New Ram Datta Road	Category 1	AMR	10.577							
5	Border	CITY AMRITSAR		DS CITY CENTER DIVN.,_ASR		DS S/D GHEE MANDI TECH.,_ASR			C754F13	11kv NEW KESRI BAGH	Category 1	AMR	2.669							
6	Border	CITY AMRITSAR		DS CITY CENTER DIVN.,_ASR		DS S/D GHEE MANDI TECH.,_ASR			D754F02	11kv Ghee Mandi 2	Category 1	AMR	5.263							
7	Border	CITY AMRITSAR		DS CITY CENTER DIVN.,_ASR		DS S/D GHEE MANDI TECH.,_ASR	64.7257		D754F01	11kv Kesri Bagh	Category 1	AMR	5.889							
8	Border	CITY AMRITSAR		DS CITY CENTER DIVN.,_ASR		DS S/D GHEE MANDI TECH.,_ASR			D754F09	11 KV MOTI BAGDAR	Category 1	AMR	6.132							
9	Border	CITY AMRITSAR		DS CITY CENTER DIVN.,_ASR		DS S/D GHEE MANDI TECH.,_ASR			D754F04	11kv Chaitiwad	Category 1	AMR	6.538							
10	Border	CITY AMRITSAR		DS CITY CENTER DIVN.,_ASR		DS S/D GHEE MANDI TECH.,_ASR			D754F03	11kv Neetdeep Theatre	Category 1	AMR	6.538							
11	Border	CITY AMRITSAR		DS CITY CENTER DIVN.,_ASR		DS S/D GHEE MANDI TECH.,_ASR			D751F19	11 KESRI BAGH HG	Category 1	AMR	0.000							
12	Border	CITY AMRITSAR		DS CITY CENTER DIVN.,_ASR		DS S/D GHEE MANDI TECH.,_ASR			D753F20	DHARAM SINGH MKT INTERLINK	Category 1	AMR	0.000							
13	Border	CITY AMRITSAR		DS CITY CENTER DIVN.,_ASR		DS S/D HUSSAINPURA TECH.,_ASR			D754F12	BHARAWA DA DHABHA	Category 1	AMR	0.000							
14	Border	CITY AMRITSAR		DS CITY CENTER DIVN.,_ASR		DS S/D HUSSAINPURA TECH.,_ASR			D754F14	11 KV SUBAHS PARK	Category 1	AMR	0.000							
15	Border	CITY AMRITSAR		DS CITY CENTER DIVN.,_ASR		DS S/D HUSSAINPURA TECH.,_ASR			D754F15	11 KV MASHI MANDI	Category 1	AMR	0.000							
16	Border	CITY AMRITSAR		DS CITY CENTER DIVN.,_ASR		DS S/D HUSSAINPURA TECH.,_ASR			D754F26	Karon Market	Category 1	NON AMR	0.000							
17	Border	CITY AMRITSAR		DS CITY CENTER DIVN.,_ASR		DS S/D HUSSAINPURA TECH.,_ASR			D754F13	11 KV TOWN HALL	Category 1	AMR	1.627							
18	Border	CITY AMRITSAR		DS CITY CENTER DIVN.,_ASR		DS S/D HUSSAINPURA TECH.,_ASR			D754F05	Cheet Mandi	Category 1	AMR	9.391							
19	Border	CITY AMRITSAR		DS CITY CENTER DIVN.,_ASR		DS S/D HUSSAINPURA TECH.,_ASR			D752F10	11kv HussainPura	Category 1	AMR	10.334							
20	Border	CITY AMRITSAR		DS CITY CENTER DIVN.,_ASR		DS S/D HUSSAINPURA TECH.,_ASR			D753F04	11kv Halli Bazar	Category 1	AMR	0.000							
21	Border	CITY AMRITSAR		DS CITY CENTER DIVN.,_ASR		DS S/D HUSSAINPURA TECH.,_ASR	47.8845		D753F10	11 KV Kabra Baphan	Category 1	AMR	0.000							
22	Border	CITY AMRITSAR		DS CITY CENTER DIVN.,_ASR		DS S/D HUSSAINPURA TECH.,_ASR			D751F14	11KV Civil Hospital Independent	Category 2	AMR	1.213							
23	Border	CITY AMRITSAR		DS CITY CENTER DIVN.,_ASR		DS S/D HUSSAINPURA TECH.,_ASR			D753F23	MASHI MANDI	Category 1	AMR	1.692							
24	Border	CITY AMRITSAR		DS CITY CENTER DIVN.,_ASR		DS S/D HUSSAINPURA TECH.,_ASR			D753F22	BHARAWA DHABHA	Category 1	AMR	1.895							
25	Border	CITY AMRITSAR		DS CITY CENTER DIVN.,_ASR	324.3589	DS S/D HUSSAINPURA TECH.,_ASR			D753F25	SUBASH PARK	Category 1	AMR	2.496							
26	Border	CITY AMRITSAR		DS CITY CENTER DIVN.,_ASR		DS S/D HUSSAINPURA TECH.,_ASR			D753F24	KARION MARKET	Category 1	NON AMR	3.567							
27	Border	CITY AMRITSAR		DS CITY CENTER DIVN.,_ASR		DS S/D HUSSAINPURA TECH.,_ASR			D753F21	TOWN HALL	Category 1	AMR	4.133							
28	Border	CITY AMRITSAR		DS CITY CENTER DIVN.,_ASR		DS S/D HUSSAINPURA TECH.,_ASR			D753F07	11kv Ram Bagh	Category 1	AMR	4.637							
29	Border	CITY AMRITSAR		DS CITY CENTER DIVN.,_ASR		DS S/D HUSSAINPURA TECH.,_ASR			D753F02	11kv Ram Bagh	Category 1	AMR	6.936							
30	Border	CITY AMRITSAR		DS CITY CENTER DIVN.,_ASR		DS S/D MALL MANDI TECH.,_ASR			C751D11	11 KV Bhai Gurdas Ji Nagar	Category 1	NON AMR	4.101							
31	Border	CITY AMRITSAR		DS CITY CENTER DIVN.,_ASR		DS S/D MALL MANDI TECH.,_ASR			C753F14	Kagpur Nagar	Category 1	AMR	7.299							
32	Border	CITY AMRITSAR		DS CITY CENTER DIVN.,_ASR		DS S/D MALL MANDI TECH.,_ASR			C751F13	66th Nagar	Category 1	AMR	13.171							
33	Border	CITY AMRITSAR		DS CITY CENTER DIVN.,_ASR		DS S/D MALL MANDI TECH.,_ASR			C801F03	J C MOTOR	Category 2	AMR	0.000							
34	Border	CITY AMRITSAR		DS CITY CENTER DIVN.,_ASR		DS S/D MALL MANDI TECH.,_ASR			C801F12	KHANKOT	Category 1	AMR	1.631							
35	Border	CITY AMRITSAR		DS CITY CENTER DIVN.,_ASR		DS S/D MALL MANDI TECH.,_ASR			C801F08	Byepass	Category 1	AMR	5.553							
36	Border	CITY AMRITSAR		DS CITY CENTER DIVN.,_ASR		DS S/D MALL MANDI TECH.,_ASR			C801F06	CT Road	Category 1	AMR	11.940							
37	Border	CITY AMRITSAR		DS CITY CENTER DIVN.,_ASR		DS S/D MALL MANDI TECH.,_ASR			C801F04	Bhai Lalaji Nagar	Category 1	AMR	13.391							
38	Border	CITY AMRITSAR		DS CITY CENTER DIVN.,_ASR		DS S/D MALL MANDI TECH.,_ASR			C801F13	GTB FOCAL POINT	Category 2	AMR	13.879							
39	Border	CITY AMRITSAR		DS CITY CENTER DIVN.,_ASR		DS S/D MALL MANDI TECH.,_ASR			C801F10	New Focal Point	Category 2	AMR	16.696							
40	Border	CITY AMRITSAR		DS CITY CENTER DIVN.,_ASR		DS S/D MALL MANDI TECH.,_ASR			C801F11	New Amritsar	Category 1	AMR	15.829							
41	Border	CITY AMRITSAR		DS CITY CENTER DIVN.,_ASR		DS S/D MALL MANDI TECH.,_ASR			C801F02	Focpoint old	Category 2	AMR	23.059							
42	Border	CITY AMRITSAR		DS CITY CENTER DIVN.,_ASR		DS S/D MALL MANDI TECH.,_ASR			D945F04	Bhai Ghantya Ji	Category 1	AMR	2.340							
43	Border	CITY AMRITSAR		DS CITY CENTER DIVN.,_ASR		DS S/D MALL MANDI TECH.,_ASR			D945S01	BABA DEEP SINGH	Category 1	AMR	7.943							
44	Border	CITY AMRITSAR		DS CITY CENTER DIVN.,_ASR		DS S/D MALL MANDI TECH.,_ASR			945F08	11 KV SULTANWIND-1	Category 1	NON AMR	11.035							
45	Border	CITY AMRITSAR		DS CITY CENTER DIVN.,_ASR		DS S/D MALL MANDI TECH.,_ASR			D945S05	BABA BUDHA Ji	Category 1	AMR	11.478							
46	Border	CITY AMRITSAR		DS CITY CENTER DIVN.,_ASR		DS S/D MALL MANDI TECH.,_ASR			945F07	11 KV DABURI	Category 1	NON AMR	12.388							
47	Border	CITY AMRITSAR		DS CITY CENTER DIVN.,_ASR		DS S/D MALL MANDI TECH.,_ASR			D945S01	ATARI SAHIB	Category 1	AMR	12.843							
48	Border	CITY AMRITSAR		DS CITY CENTER DIVN.,_ASR		DS S/D MALL MANDI TECH.,_ASR			D833F10	11 KV WALLAH	Category 1	AMR	12.843							
49	Border	CITY AMRITSAR		DS CITY CENTER DIVN.,_ASR		DS S/D MALL MANDI TECH.,_ASR			C751D01	Apha G	Category 1	Not available	13.273							
50	Border	CITY AMRITSAR		DS CIVIL LINE DIVN.,_ASR		DS S/D CIVIL LINE TECH.,_ASR			D846F05	BEATY AVENUE	Category 1	AMR	6.863							
51	Border	CITY AMRITSAR		DS CIVIL LINE DIVN.,_ASR		DS S/D CIVIL LINE TECH.,_ASR			D755F08	DNT	Category 1	AMR	7.278							
52	Border	CITY AMRITSAR		DS CIVIL LINE DIVN.,_ASR		DS S/D CIVIL LINE TECH.,_ASR			D755F07	DISTRCT COURT	Category 1	AMR	2.730							
53	Border	CITY AMRITSAR		DS CIVIL LINE DIVN.,_ASR		DS S/D CIVIL LINE TECH.,_ASR			D755F09	COURT ROAD	Category 1	AMR	2.778							
54	Border	CITY AMRITSAR		DS CIVIL LINE DIVN.,_ASR		DS S/D CIVIL LINE TECH.,_ASR			D755F02	CANTT ROAD	Category 1	AMR	4.307							
55	Border	CITY AMRITSAR		DS CIVIL LINE DIVN.,_ASR		DS S/D CIVIL LINE TECH.,_ASR			D755F10	MAHINDERA COLONY	Category 1	AMR	4.437							
56	Border	CITY AMRITSAR		DS CIVIL LINE DIVN.,_ASR		DS S/D CIVIL LINE TECH.,_ASR	76.9077		D755F03	RANI KA BAGH	Category 1	AMR	5.608							
57	Border	CITY AMRITSAR		DS CIVIL LINE DIVN.,_ASR		DS S/D CIVIL LINE TECH.,_ASR			D755F05	MOHAN HOTEL	Category 1	AMR	6.497							
58	Border	CITY AMRITSAR		DS CIVIL LINE DIVN.,_ASR		DS S/D CIVIL LINE TECH.,_ASR			D755F11	KENNEDY AVENUE	Category 1	AMR	6.771							
59	Border	CITY AMRITSAR		DS CIVIL LINE DIVN.,_ASR		DS S/D CIVIL LINE TECH.,_ASR			D755F06	MODEL TOWN	Category 1	AMR	6.960							
60	Border	CITY AMRITSAR		DS CIVIL LINE DIVN.,_ASR		DS S/D CIVIL LINE TECH.,_ASR			D755F01	GREEN AVENUE	Category 1	AMR	9.285							
61	Border	CITY AMRITSAR		DS CIVIL LINE DIVN.,_ASR		DS S/D CIVIL LINE TECH.,_ASR			D803F01	BASANT AVENUE	Category 1	AMR	5.868							
62	Border	CITY AMRITSAR		DS CIVIL LINE DIVN.,_ASR		DS S/D CIVIL LINE TECH.,_ASR			D803F09	ANAND AVENUE	Category 1	AMR	6.148							
63	Border	CITY AMRITSAR		DS CIVIL LINE DIVN.,_ASR		DS S/D CIVIL LINE TECH.,_ASR			D803F07	GOBRIO Nagar	Category 1	AMR	8.846							
64	Border	CITY AMRITSAR		DS CIVIL LINE DIVN.,_ASR		DS S/D ISLAMABAD TECH.,_ASR			D838F01	KISHANKOT	Category 1	AMR	4.918							
65	Border	CITY AMRITSAR		DS CIVIL LINE DIVN.,_ASR		DS S/D ISLAMABAD TECH.,_ASR			D838F03	GURUDWARA TAPOWAN	Category 1	AMR	5.197							
66	Border	CITY AMRITSAR		DS CIVIL LINE DIVN.,_ASR		DS S/D ISLAMABAD TECH.,_ASR			D838F06	11 kv Nanpura Feeder	Category 1	AMR	7.082							
67	Border	CITY AMRITSAR		DS CIVIL LINE DIVN.,_ASR		DS S/D ISLAMABAD TECH.,_ASR			D838F02	BHANDARI CHOWK	Category 1	AMR	8.520							
68	Border	CITY AMRITSAR		DS CIVIL LINE DIVN.,_ASR		DS S/D ISLAMABAD TECH.,_ASR			D838F04	KHOO BHALLA	Category 1	AMR	10.889							
69	Border	CITY AMRITSAR		DS CIVIL LINE DIVN.,_ASR		DS S/D ISLAMABAD TECH.,_ASR			D838F08	NAVANKOT	Category 1	AMR	11.911							
70	Border	CITY AMRITSAR		DS CIVIL LINE DIVN.,_ASR		DS S/D ISLAMABAD TECH.,_ASR			D838F05	DHAPAI INDUSTRIAL	Category 1	AMR	15.454							
71	Border	CITY AMRITSAR		DS CIVIL LINE DIVN.,_ASR		DS S/D ISLAMABAD TECH.,_ASR			D753F04	CHAH NIHANGSA	Category 1	AMR	0.000							
72	Border	CITY AMRITSAR		DS CIVIL LINE DIVN.,_ASR	287.6375															

3738	Central	SUB URBAN LUDHIANA	DS DIVN. ADDA DAKHA	DS S/U S/D ADDA DAKHA	COS1F06	SIADD(IU)	Category 5-UPS	NON AMR	5.609		
3739	Central	SUB URBAN LUDHIANA	DS DIVN. ADDA DAKHA	DS S/U S/D ADDA DAKHA	D054F06	Pandori	AP 3Phase 3Wire	AMR	1.513		
3740	Central	SUB URBAN LUDHIANA	DS DIVN. ADDA DAKHA	DS S/U S/D ADDA DAKHA	D054F21	Madani	AP 3Phase 3Wire	AMR	2.000		
3741	Central	SUB URBAN LUDHIANA	DS DIVN. ADDA DAKHA	DS S/U S/D ADDA DAKHA	D054F08	Tawandi	AP 3Phase 3Wire	AMR	2.270		
3742	Central	SUB URBAN LUDHIANA	DS DIVN. ADDA DAKHA	DS S/U S/D ADDA DAKHA	D054F03	Mulayangi	AP 3Phase 3Wire	AMR	2.383		
3743	Central	SUB URBAN LUDHIANA	DS DIVN. ADDA DAKHA	DS S/U S/D ADDA DAKHA	D054F12	Issewa(I)	AP 3Phase 3Wire	AMR	2.482		
3744	Central	SUB URBAN LUDHIANA	DS DIVN. ADDA DAKHA	DS S/U S/D ADDA DAKHA	D054F22	Dakha	AP 3Phase 3Wire	AMR	2.495		
3745	Central	SUB URBAN LUDHIANA	DS DIVN. ADDA DAKHA	DS S/U S/D ADDA DAKHA	D054F17	Kaibpur	AP 3Phase 3Wire	AMR	2.551		
3746	Central	SUB URBAN LUDHIANA	DS DIVN. ADDA DAKHA	DS S/U S/D ADDA DAKHA	D054F05	Deval	AP 3Phase 3Wire	AMR	3.390		
3747	Central	SUB URBAN LUDHIANA	DS DIVN. ADDA DAKHA	DS S/U S/D ADDA DAKHA	D054F24	Boothgarh	Category 5-UPS	AMR	4.719		
3748	Central	SUB URBAN LUDHIANA	DS DIVN. ADDA DAKHA	DS S/U S/D ADDA DAKHA	D054F14	Issewa(IU)	Category 5-UPS	AMR	9.196		
3749	Central	SUB URBAN LUDHIANA	DS DIVN. ADDA DAKHA	DS S/U S/D ADDA DAKHA	D054F03	Shelva City	Category 5-UPS	AMR	16.262		
3750	Central	SUB URBAN LUDHIANA	DS DIVN. ADDA DAKHA	DS S/U S/D ADDA DAKHA	D055F14	raQBA	Category 5-UPS	AMR	1.400		
3751	Central	SUB URBAN LUDHIANA	DS DIVN. ADDA DAKHA	DS S/U S/D ADDA DAKHA	D055F24	Raaba (U)	Category 5-UPS	AMR	2.748		
3752	Central	SUB URBAN LUDHIANA	DS DIVN. ADDA DAKHA	DS S/U S/D ADDA DAKHA	D070F07	Dhatt	AP 3Phase 3Wire	AMR	2.155		
3753	Central	SUB URBAN LUDHIANA	DS DIVN. ADDA DAKHA	DS S/U S/D ADDA DAKHA	D070F06	Sahngani	Category 5-UPS	AMR	3.990		
3754	Central	SUB URBAN LUDHIANA	DS DIVN. AHMEDGARH	DS CITY S/D AHD	D062P17	SUB STATION CITY AHMEDGARH	Category 5-1	NON AMR	0.036		
3755	Central	SUB URBAN LUDHIANA	DS DIVN. AHMEDGARH	DS CITY S/D AHD	D062P18	Jagdish Chand	Category 4	NON AMR	2.034		
3756	Central	SUB URBAN LUDHIANA	DS DIVN. AHMEDGARH	DS CITY S/D AHD	D062P15	Urban Ahmedgarh (City-3)	Category 1	NON AMR	6.196		
3757	Central	SUB URBAN LUDHIANA	DS DIVN. AHMEDGARH	DS CITY S/D AHD	D062P24	Urban Main Bazar (City-4)	Category 1	NON AMR	6.483		
3758	Central	SUB URBAN LUDHIANA	DS DIVN. AHMEDGARH	DS CITY S/D AHD	D062P08	Urban Raikot Adda (City-1)	Category 1	NON AMR	7.404		
3759	Central	SUB URBAN LUDHIANA	DS DIVN. AHMEDGARH	DS CITY S/D AHD	D062P33	Urban Gandhi School	Category 1	AMR	7.492		
3760	Central	SUB URBAN LUDHIANA	DS DIVN. AHMEDGARH	DS CITY S/D AHD	D062P31	Urban Anad isher School	Category 1	AMR	9.158		
3761	Central	SUB URBAN LUDHIANA	DS DIVN. AHMEDGARH	DS CITY S/D AHD	D062P32	Urban Victoria College	Category 1	AMR	9.998		
3762	Central	SUB URBAN LUDHIANA	DS DIVN. AHMEDGARH	DS CITY S/D AHD	D062P04	Urban New Gau Shala (City-2)	Category 1	NON AMR	12.519		
3763	Central	SUB URBAN LUDHIANA	DS DIVN. AHMEDGARH	DS CITY S/D AHD	D062P09	SHRIYANS PAPER MILL	Category 4	NON AMR	16.430		
3764	Central	SUB URBAN LUDHIANA	DS DIVN. AHMEDGARH	DS S/D MALOUD	D062P13	JOGPURI	AP 3Phase 3Wire	AMR	0.006		
3765	Central	SUB URBAN LUDHIANA	DS DIVN. AHMEDGARH	DS S/D MALOUD	D063F08	SUB STATION MALOUD	Category 5-UPS	AMR	0.001		
3766	Central	SUB URBAN LUDHIANA	DS DIVN. AHMEDGARH	DS S/D MALOUD	D063F11	Chommo	AP 3Phase 3Wire	AMR	0.040		
3767	Central	SUB URBAN LUDHIANA	DS DIVN. AHMEDGARH	DS S/D MALOUD	D063F01	Dudhal	AP 3Phase 3Wire	AMR	0.773		
3768	Central	SUB URBAN LUDHIANA	DS DIVN. AHMEDGARH	DS S/D MALOUD	D063F03	Naromajra	AP 3Phase 3Wire	AMR	1.794		
3769	Central	SUB URBAN LUDHIANA	DS DIVN. AHMEDGARH	DS S/D MALOUD	D063F15	TARBHAL	AP 3Phase 3Wire	AMR	2.964		
3770	Central	SUB URBAN LUDHIANA	DS DIVN. AHMEDGARH	DS S/D MALOUD	D063F14	SEKHA	AP 3Phase 3Wire	AMR	2.269		
3771	Central	SUB URBAN LUDHIANA	DS DIVN. AHMEDGARH	DS S/D MALOUD	D063F04	Soltian	AP 3Phase 3Wire	AMR	2.309		
3772	Central	SUB URBAN LUDHIANA	DS DIVN. AHMEDGARH	DS S/D MALOUD	D063F09	Ramgh	AP 3Phase 3Wire	AMR	2.600		
3773	Central	SUB URBAN LUDHIANA	DS DIVN. AHMEDGARH	DS S/D MALOUD	D063F17	URSI	AP 3Phase 3Wire	AMR	2.754		
3774	Central	SUB URBAN LUDHIANA	DS DIVN. AHMEDGARH	DS S/D MALOUD	D063F02	Daud	AP 3Phase 3Wire	AMR	4.326		
3775	Central	SUB URBAN LUDHIANA	DS DIVN. AHMEDGARH	DS S/D MALOUD	D063F16	City-4	Category 1	AMR	4.372		
3776	Central	SUB URBAN LUDHIANA	DS DIVN. AHMEDGARH	DS S/D MALOUD	D063F10	Maha Daud	AP 3Phase 3Wire	AMR	4.456		
3777	Central	SUB URBAN LUDHIANA	DS DIVN. AHMEDGARH	DS S/D MALOUD	D063F06	Berkhal	AP 3Phase 3Wire	AMR	5.551		
3778	Central	SUB URBAN LUDHIANA	DS DIVN. AHMEDGARH	DS S/D MALOUD	D063F07	City-02	Category 5-UPS	NON AMR	6.162		
3779	Central	SUB URBAN LUDHIANA	DS DIVN. AHMEDGARH	DS S/D MALOUD	D063F05	City-1 Maloud	Category 1	NON AMR	7.040		
3780	Central	SUB URBAN LUDHIANA	DS DIVN. AHMEDGARH	DS S/D MALOUD	D063F12	City No.3 Maloud	Category 5-UPS	AMR	11.239		
3781	Central	SUB URBAN LUDHIANA	DS DIVN. AHMEDGARH	DS S/D MALOUD	D064F15	gosal	AP 3Phase 3Wire	AMR	1.587		
3782	Central	SUB URBAN LUDHIANA	DS DIVN. AHMEDGARH	DS S/D SHAR	D064F09	SUB STATION SHAR	Category 1	NON AMR	0.019		
3783	Central	SUB URBAN LUDHIANA	DS DIVN. AHMEDGARH	DS S/D SHAR	D064F06	Zrnh	AP 3Phase 3Wire	AMR	1.111		
3784	Central	SUB URBAN LUDHIANA	DS DIVN. AHMEDGARH	DS S/D SHAR	D064F17	KULAN HANS	AP 3Phase 3Wire	AMR	1.404		
3785	Central	SUB URBAN LUDHIANA	DS DIVN. AHMEDGARH	DS S/D SHAR	D064F14	KHATTRA	AP 3Phase 3Wire	AMR	1.534		
3786	Central	SUB URBAN LUDHIANA	DS DIVN. AHMEDGARH	DS S/D SHAR	D064F13	ROSIANA	AP 3Phase 3Wire	AMR	1.663		
3787	Central	SUB URBAN LUDHIANA	DS DIVN. AHMEDGARH	DS S/D SHAR	D064F12	PANDHER KHERI	AP 3Phase 3Wire	NON AMR	1.780		
3788	Central	SUB URBAN LUDHIANA	DS DIVN. AHMEDGARH	DS S/D SHAR	D064F16	SAHANAN MAHA UPS	Category 5-UPS	AMR	1.820		
3789	Central	SUB URBAN LUDHIANA	DS DIVN. AHMEDGARH	DS S/D SHAR	D064F10	Sisar	AP 3Phase 3Wire	AMR	1.856		
3790	Central	SUB URBAN LUDHIANA	DS DIVN. AHMEDGARH	DS S/D SHAR	D064F02	Battari	AP 3Phase 3Wire	AMR	2.498		
3791	Central	SUB URBAN LUDHIANA	DS DIVN. AHMEDGARH	DS S/D SHAR	D064F04	Dhau Kalan	AP 3Phase 3Wire	AMR	2.708		
3792	Central	SUB URBAN LUDHIANA	DS DIVN. AHMEDGARH	DS S/D SHAR	D064F05	City-2	Category 5-UPS	NON AMR	4.907		
3793	Central	SUB URBAN LUDHIANA	DS DIVN. AHMEDGARH	DS S/D SHAR	D064F11	Bhahn UPS	Category 5-UPS	AMR	7.657		
3794	Central	SUB URBAN LUDHIANA	DS DIVN. AHMEDGARH	DS S/D SHAR	D064F07	city-2	Category 5-UPS	NON AMR	10.487		
3795	Central	SUB URBAN LUDHIANA	DS DIVN. AHMEDGARH	DS S/U S/D NO-1 AHD	D062P29	DAMDAMA SAHIB	AP 3Phase 3Wire	AMR	1.234		
3796	Central	SUB URBAN LUDHIANA	DS DIVN. AHMEDGARH	DS S/U S/D NO-1 AHD	D062P19	RAM TALAI	AP 3Phase 3Wire	AMR	1.723		
3797	Central	SUB URBAN LUDHIANA	DS DIVN. AHMEDGARH	DS S/U S/D NO-1 AHD	D062P06	HAMAT	AP 3Phase 3Wire	AMR	2.178		
3798	Central	SUB URBAN LUDHIANA	DS DIVN. AHMEDGARH	DS S/U S/D NO-1 AHD	D062P21	Umarpura	AP 3Phase 3Wire	AMR	2.241		
3799	Central	SUB URBAN LUDHIANA	DS DIVN. AHMEDGARH	DS S/U S/D NO-1 AHD	D062P05	CHANNI	AP 3Phase 3Wire	AMR	2.620		
3800	Central	SUB URBAN LUDHIANA	DS DIVN. AHMEDGARH	DS S/U S/D NO-1 AHD	D062P28	AAZAD FEEDER (ATHRVA)	Category 1	AMR	2.423		
3801	Central	SUB URBAN LUDHIANA	DS DIVN. AHMEDGARH	DS S/U S/D NO-1 AHD	D062P22	JANDALI	AP 3Phase 3Wire	AMR	2.448		
3802	Central	SUB URBAN LUDHIANA	DS DIVN. AHMEDGARH	DS S/U S/D NO-1 AHD	D062P20	Rangan	AP 3Phase 3Wire	AMR	2.449		
3803	Central	SUB URBAN LUDHIANA	DS DIVN. AHMEDGARH	DS S/U S/D NO-1 AHD	D062F03	BHOURNI	AP 3Phase 3Wire	NON AMR	2.550		
3804	Central	SUB URBAN LUDHIANA	DS DIVN. AHMEDGARH	DS S/U S/D NO-1 AHD	D062P13	CHANNI	AP 3Phase 3Wire	AMR	2.620		
3805	Central	SUB URBAN LUDHIANA	DS DIVN. AHMEDGARH	DS S/U S/D NO-1 AHD	D062P30	KULHAR FEEDER	AP 3Phase 3Wire	AMR	2.665		
3806	Central	SUB URBAN LUDHIANA	DS DIVN. AHMEDGARH	DS S/U S/D NO-1 AHD	D062P12	VKSUKICHAN	Category 4	AMR	5.522		
3807	Central	SUB URBAN LUDHIANA	DS DIVN. AHMEDGARH	DS S/U S/D NO-1 AHD	D062P14	UPS	Category 5-UPS	NON AMR	8.183		
3808	Central	SUB URBAN LUDHIANA	DS DIVN. AHMEDGARH	DS S/U S/D NO-1 AHD	D062P02	NATHUMAARA	Category 5-UPS	NON AMR	8.570		
3809	Central	SUB URBAN LUDHIANA	DS DIVN. AHMEDGARH	DS S/U S/D NO-1 AHD	D062P07	INDUSTRY	Category 1	NON AMR	12.966		
3810	Central	SUB URBAN LUDHIANA	DS DIVN. AHMEDGARH	DS S/U S/D NO-1 AHD	D062P26	11 KV LDRHA UPS FEEDER	Category 5-UPS	AMR	13.272		
3811	Central	SUB URBAN LUDHIANA	DS DIVN. AHMEDGARH	DS S/U S/D NO-1 AHD	D062P11	G.15	Category 1	NON AMR	27.076		
3812	Central	SUB URBAN LUDHIANA	DS DIVN. AHMEDGARH	DS S/U S/D NO-1 AHD	D213F16	GHALLUGHARA	AP 3Phase 3Wire	AMR	2.110		
3813	Central	SUB URBAN LUDHIANA	DS DIVN. AHMEDGARH	DS S/U S/D NO-1 AHD	D213F06	JOGMAURA	AP 3Phase 3Wire	AMR	2.190		
3814	Central	SUB URBAN LUDHIANA	DS DIVN. AHMEDGARH	DS S/U S/D NO-2 AHD	D065F14	RACHHIN DHATTI	AP 3Phase 3Wire	AMR	1.959		
3815	Central	SUB URBAN LUDHIANA	DS DIVN. AHMEDGARH	DS S/U S/D NO-2 AHD	D065F15	BABA DHATTI	AP 3Phase 3Wire	AMR	2.017		
3816	Central	SUB URBAN LUDHIANA	DS DIVN. AHMEDGARH	DS S/U S/D NO-2 AHD	D065F08	DHURKOT	AP 3Phase 3Wire	AMR	2.391		
3817	Central	SUB URBAN LUDHIANA	DS DIVN. AHMEDGARH	DS S/U S/D NO-2 AHD	D065F17	SANTPURA	AP 3Phase 3Wire	AMR	2.432		
3818	Central	SUB URBAN LUDHIANA	DS DIVN. AHMEDGARH	DS S/U S/D NO-2 AHD	D065F16	MUARA	AP 3Phase 3Wire	AMR	2.495		
3819	Central	SUB URBAN LUDHIANA	DS DIVN. AHMEDGARH	DS S/U S/D NO-2 AHD	D065F06	MAHARANA KALAN	AP 3Phase 3Wire	AMR	2.905		
3820	Central	SUB URBAN LUDHIANA	DS DIVN. AHMEDGARH	DS S/U S/D NO-2 AHD	D065F09	MAHOLI	AP 3Phase 3Wire	AMR	2.534		
3821	Central	SUB URBAN LUDHIANA	DS DIVN. AHMEDGARH	DS S/U S/D NO-2 AHD	D065F03	BARAHAMPUR	AP 3Phase 3Wire	AMR	2.685		
3822	Central	SUB URBAN LUDHIANA	DS DIVN. AHMEDGARH	DS S/U S/D NO-2 AHD	D065F11	Rasripur	AP 3Phase 3Wire	AMR	3.027		
3823	Central	SUB URBAN LUDHIANA	DS DIVN. AHMEDGARH	DS S/U S/D NO-2 AHD	D065F21	Ghangana UPS	Category 5-UPS	AMR	6.875		
3824	Central	SUB URBAN LUDHIANA	DS DIVN. AHMEDGARH	DS S/U S/D NO-2 AHD	D065F10	RACHHIN	Category 5-UPS	NON AMR	10.543		
3825	Central	SUB URBAN LUDHIANA	DS DIVN. AHMEDGARH	DS S/U S/D NO-2 AHD	D062P27	GUGA MARI	AP 3Phase 3Wire	AMR	1.489		
3826	Central	SUB URBAN LUDHIANA	DS DIVN. AHMEDGARH	DS S/U S/D NO-2 AHD	D062P23	Amra	AP 3Phase 3Wire	AMR	2.124		
3827	Central	SUB URBAN LUDHIANA	DS DIVN. AHMEDGARH	DS S/U S/D NO-2 AHD	D062P25	Chnagar	AP 3Phase 3Wire	AMR	2.206		
3828	Central	SUB URBAN LUDHIANA	DS DIVN. AHMEDGARH	DS S/U S/D NO-2 AHD	D062P01	DAHUZ KALAN	AP 3Phase 3Wire	AMR	2.724		
3829	Central	SUB URBAN LUDHIANA	DS DIVN. AHMEDGARH	DS S/U S/D NO-2 AHD	D062P10	GHUNGURANA	AP 3Phase 3Wire	NON AMR	2.795		
3830	Central	SUB URBAN LUDHIANA	DS DIVN. JAGRAON	DS CITY S/D JAGRAON	BO53F03	FEL	Category 1	AMR	6.430		
3831	Central	SUB URBAN LUDHIANA	DS DIVN. JAGRAON	DS CITY S/D JAGRAON	BO53F08	CITY-1	Category 1	AMR	6.559		
3832	Central	SUB URBAN LUDHIANA	DS DIVN. JAGRAON	DS CITY S/D JAGRAON	BO53F02	CITY-3	Category 1	NON AMR	8.362		
3833	Central	SUB URBAN LUDHIANA	DS DIVN. JAGRAON	DS CITY S/D JAGRAON	BO53F24	CENTER CITY	Category 1	AMR	8.559		
3834	Central	SUB URBAN LUDHIANA	DS DIVN. JAGRAON	DS CITY S/D JAGRAON	BO53F22	RAI WAN ROAD	Category 1	AMR	9.016		
3835	Central	SUB URBAN LUDHIANA	DS DIVN. JAGRAON	DS CITY S/D JAGRAON	BO53F01	CITY-4	Category 1	NON AMR	9.018		
3836	Central	SUB URBAN LUDHIANA	DS DIVN. JAGRAON	DS CITY S/D JAGRAON	BO53F14	CITY-2	Category 1	NON AMR	10.620		
3837	Central	SUB URBAN LUDHIANA	DS DIVN. JAGRAON	DS CITY S/D JAGRAON	D068F04	CITY-6	Category 1	NON AMR	9.175		
3838	Central	SUB URBAN LUDHIANA	DS DIVN. JAGRAON	DS CITY S/D JAGRAON	D068F12	CITY AND 07	Category 1	AMR	9.469		
3839	Central	SUB URBAN LUDHIANA	DS DIVN. JAGRAON	DS CITY S/D JAGRAON	D068F03	CITY-5	Category 1	NON AMR	11.714		
3840	Central	SUB URBAN LUDHIANA	DS DIVN. JAGRAON	DS S/D SIDHWAN BET	COS1F08	DHOTHR	AP 3Phase 3Wire	NON AMR	1.989		
3841	Central	SUB URBAN LUDHIANA	DS DIVN. JAGRAON	DS S/D SIDHWAN BET	COS1F10	DHOTHRAR UPS	Category 5-UPS	NON AMR	4.623		

"A"(Details of Distribution Transformers(DT) Level Information)

Period From 01.04.2022To 31.03.2023										
Zone	Circle	Division	Feeder Name	Total No. of DT on Feeder	No. of Unmetered DTs	No. of Metered Dts			No. of DTs with functional meters	
1	2	3	4	5=(6+7+8+9)	6	7	8	9	10	11
Total Transformers ending month						3/2023				
	5 KVA	6.3 KVA	10 KVA	15 KVA	16 KVA	25 KVA	63 KVA	100 KVA	above 100 KVA	Total
PSPCL	42	91998	357959	1	195407	278305	133251	117537	25800	1200300

Sr. No.	Zone	Circle	Division	Total No. of DTs installed	No. of DTs where AMR Meters Installed	No. of DTs where Non AMR meters Installed	No. of Unmetered DTs	No. of DTs with functional Meters
1	Border	Gurdaspu	City Batala	7113	472	111	6530	583
2			Sub Batala	13264	231	61	12972	292
3			Qadian	12156	185	95	11876	280
4			Dharawal	7468	118	43	7307	161
5			Gurdaspur	8922	278	133	8511	411
6			City Pathank	5058	390	164	4504	554
7			Sub Pathank	4749	412	203	4134	615
			Total	58730	2086	810	55834	2896
8		Sub Asr	EAST	3735	360	216	3159	47
9			WEST	11606	0	41	11565	41
10			SUBURBAN	17571	52	150	17369	197
11			AJNALA	20026	178	9	19839	178
12		JANDIALA	9861	152	17	9692	152	
			Total	62799	742	433	61624	615
13		City Asr	Ind	646	223	0	423	20
14			CL	863	520	0	343	212
15			CC	1114	109	0	1005	23
16			HG	485	281	0	204	53
			Total	3108	1133	0	1975	308
17		Tarn Taran	Rayva	15394	40	0	15354	40
18			City TT	15204	162	0	15042	162
19	SUB TT		12563	0	63	12500	63	
20	PATTI		18757	0	98	18659	98	
21		Bhikhiwind	19268	0	0	19268	0	
		Total	81186	202	161	80823	363	
		Border Zone Total	205823	4163	1404	200256	4182	
22	Central	East	CityCenter	339	110	0	229	175
23			CMC	1299	661	132	506	302
24			Focal Point	3531	680	2478	373	1950
25			Sunder	3764	1090	765	1909	1340
				Total	8933	2541	3375	3017
26		West	Aqdar Nagar	2156	0	1135	1021	1031
27			Modal Town	4244	0	571	3673	0
28			City West	1618	1296	29	293	1268
29			Estate	1042	977	16	49	683
30			Janta Nagar	2262	0	1303	959	920
			Total	11322	2273	3054	5995	3902
31		Khanna	Khanna	8943	575	896	7472	721
32			Doraha	5036	163	299	4574	301
33			MGG	1824	106	316	1402	316
34			Amloh	11286	0	272	11014	0
35			Sirhind	15590	20	532	15038	12
			Total	42679	864	2315	39500	1350
36		S/U Ludhiana	Lalton Kalan	6108	2	0	6106	2
37			Adda Dakha	6359	137	0	0	137
38			Jagraon	8088	325	49	7714	374
39	Raikot		11752	250	0	11502	250	
40	Ahmedgarh		5973	218	25	5730	0	
		Total	38280	932	74	37274	763	
		Central Zone Total	101214	6610	8818	85786	9782	

41	North	Jalandhar	Cantt	4469	1099	0	3370	1099	
42			East	3199	1296	0	1903	1095	
43			MT	4180	716	0	3464	716	
44			West	1964	1180	0	784	982	
45			Phag	6379	585	69	5725	514	
			Total	20191	4876	69	15246	4406	
46		Hoshiarpur	City Hsp	4831	472	142	4217	460	
47			Sub Hsp	8381	205	0	8176	24	
48			Dasuya	6439	128	167	6144	167	
49			Mukerian	7387	234	0	7153	212	
50			Mahipur	8697	0	72	8625	72	
51			Bhogpur	6930	71	34	6825	76	
			Total	42665	1110	415	41140	1011	
52		Nawanshahr	Nawanshahr	6651	363	0	6288	363	
53			Banga	6959	0	148	6811	148	
54			Garhshankar	8353	253	0	8100	253	
55			Goraya	7750	178	270	7302	448	
				Total	29713	794	418	28501	1212
56		Kapurthala	City Divn	11710	528	0	11182	528	
57			KPT	7429	29	124	7276	153	
			Sub.Divn .						
58			City Nakoder	14563	102	242	14219	344	
			Sub.Divn .						
59			Nakoder	14501	229	0	14272	229	
60			Kartarpur	11195	240	254	10701	494	
			Total	59398	1128	620	57650	1748	
			North Zone Total	151967	7908	1522	142537	8377	
61		South	Patiala	East	14807	0	80	14727	0
62				West	1613	1287	0	325	1182
63				Model Town	1059	990	0	69	388
64	Sub Urban			11918	0	0	11918	0	
65	Rajpura			10108	825	0	9283	0	
66	Nabha			15723	356	60	15307	320	
67	Samana			17763	807	63	16893	0	
			Total	72991	4265	203	68523	1890	
68	Sangrur		Sangrur	17092	522	19	16551	499	
69			Sunam	21563	220	2371	18972	2139	
70			Lehragaga	20032	282	0	19750	282	
71			Dirba	17510	60	87	17363	78	
72			Patran	20212	345	153	19714	450	
				Total	96409	1429	2630	92350	3448
73	Barnala		City Barnala	27860	349	32	27479	105	
74			Sub Urban	21516	370	0	21146	370	
75			Malerkotla	20504	114	256	20134	0	
76			Dhuri	20124	275	15	19834	275	
			Total	90004	1108	303	88593	750	
77	Ropar		Ropar	7217	325	0	6892	325	
78			Anandpur Sahib	5835	189	0	5646	189	
79			Kharar	8869	0	871	7998	0	
80			Samrala	11482	0	250	11232	0	
				Total	33403	514	1121	31768	514
81	Mohali		Mohali	4759	2695	0	2064	1887	
82			Zirakpur	5271	531	0	4740	415	
83			Lalru	7242	265	0	6977	185	
			Total	17272	3491	0	13781	2487	
			South Zone Total	310079	10807	4257	295015	9089	
84	West		Bathinda	Bathinda	23185	503	1748	20934	834
85		Rampura		13520	63	30	13427	30	
86		Bhagta		19166	0	198	18968	198	
87		Maur		29688	0	177	29511	177	
88		Mansa		24460	92	207	24161	202	
89		Budlada		24173	95	138	23940	233	
			Total	134192	753	2498	130941	1674	
90		Faridkot	Faridkot	15862	375	0	15487	84	
91			Kotkapura	24677	380	0	24297	89	
92			City.Moga	17627	380	0	17247	97	
93			Sub .Moga	12024	360	0	11664	94	
94			Baghapurana	23810	365	0	23445	63	
			Total	94000	1860	0	92140	427	
95		Ferozepur	City Ferozepu	13267	467	70	12730	385	
96			S/U Ferozepu	10928	351	0	10577	195	
97	Jalalabad		28025	0	95	27930	0		
98	Zira		23566	232	0	23334	0		

		Total	75786	1050	165	74571	580
99		Muktsar .	25876	0	530	25346	326
100		Malout .	26880	336	82	26462	267
101	Sri Muktsar Sahib	Gidderbaha .	17568	223	0	17345	0
102		Abohar .	17294	442	96	16756	116
103		Fazilka .	22067	37	335	21695	7
104		Badal .	17554	0	24	17530	5
		Total	127239	1038	1067	125134	721
	West Zone	431217	4701	3730	422786	3402	
	PSPCL Grand Total	1200300	34189	19731	1146380	34832	

"B" Details of DT-wise losses (please add more rows as per requirement)

Zone Name	Circle name	Division name	Name of the Sub-division	Name of the Sub-station	Substation Code	Name of the 11 kV Feeder	Feeder Code	Name of the Location where DT situated	DT code	DT Capacity (kVA)	Predominant consumer type of DT (Domestic/Industrial/Agriculture/Mixed)	Type of metering AMR/AMI/Communicable/Conventional metered/Unmetered	Status of Meter-whether Functional (Yes/No)	% of data received automatically (if AMR/AMI)	No. of Connected Consumers	Input Energy (MU) (A)	Billed Energy (MU) (B)	Loss (MU) (A-B)	% DT Loss (A-B)/A

Note : DT wise losses are not available Presently.

Annexure - 1 : Proforma for Quarterly Consumer Category-wise Subsidy Billed/Received/Due for period April 2022 to March 2023

Consumer Category (Separate for each subsidized consumer category)	Billed Energy			Subsidized Billed Energy			Applicable rate of Subsidy as notified by State Govt.		Subsidy Due from State Govt.			Subsidy Actually Billed/claimed from State Govt. (As against col.12)	Subsidy Received from State Govt. (As against col.13)	Balance Subsidy yet to be Received from State Govt.
	Metered	Un-metered*	Total	Metered (out of col.2)	Un-metered* (Out of col.3)	Total	Metered Energy**	Un-metered Energy**	Metered Energy	Un-metered Energy	Total			
	(In kwh)			(In kwh)			(In Rs/Kwh)		(In Rs. Cr.)					
	1	2	3	4=2+3	5	6	7=5+6	8	9	10=5x8	11=6x9			
Residential	15986000000		15986000000	15986000000		15986000000			6322.31		6322.31	6322.31	6470.92	-148.61
Agriculture	13981670000		13981670000	13981670000		13981670000			7913.27		7913.27	7913.27	7294.53	618.74
Commercial/Industrial-LT	22132290000		22132290000	22132290000		22132290000			2198.88		2198.88	2198.88	2669.01	-470.13
Commercial/Industrial-HT														
Other (Specify) WW														0.00
Total	52099960000	0	52099960000	52099960000	0	52099960000	0.00	0.00	16434.46	0.00	16434.46	16434.46	16434.46	0.00

- Note: 1 Balance subsidy as per column no. 15 will be claimed after True up of FY 2022-23
Arrears of subsidy ass on 01.04.2022 are not included in above as Liquidation Plan has already been sent to
GoP for approval.
- Note: 2
- Note: 3 Consumption and subsidy data of domestic and industrial category are provisional as the details of same has
not been provided by the O/o CE/IT. The same will be updated after receipt of same from the concerned office.

General Information

1	Name of the DISCOM	Punjab State Power Corporation Limited (PSPCL)		
2	i) Year of Establishment	2010		
	ii) Government/Public/Private	Government		
3	DISCOM's Contact details & Address			
i	City/Town/Village	Patiala		
ii	District	Patiala		
iii	State	Punjab	Pin	147001
iv	Telephone	0175-2212005	Fax	0175-2213199
4	Registered Office			
i	Company's Chief Executive Name	Er. Baldev Singh Sran		
ii	Designation	CMD PSPCL		
iii	Address	The Mall, Patiala		
iv	City/Town/Village	Patiala	P.O.	Patiala
v	District	Patiala		
vi	State	Punjab	Pin	147001
vii	Telephone	0175-2212005	Fax	0175-2213199
5	Nodal Officer Details*			
i	Nodal Officer Name (Designated at DISCOM's)	Er. Hira Lal Goyal		
ii	Designation	Chief Engineer (Energy Audit & Enforcement)		
iii	Address	Shed No. B2, Shakti Vihar, Patiala		
iv	City/Town/Village	Patiala	P.O.	Patiala
v	District	Patiala		
vi	State	Punjab	Pin	147001
vii	Telephone	0175-2215774	Fax	0175-2215774
6	Energy Manager Details*			
i	Name	Er. Ravi Verma		
ii	Designation	ASE	Whether EA or EM	EA
iii	EA/EM Registration No.	EA-7969		
iv	Telephone		Fax	
v	Mobile	96461 21187	E-mail ID	ivarverma76@gmail.com
7	Period of Information			
	Year of (FY) information including Date and Month (Start & End)	1 APRIL 2022 - 31 March 2023		

S.E./DSM,
P.S.P.C.L., Patiala

Er. Ravi Verma
EA- 7969
Energy Auditor
PSPCL, Patiala.

Performance Summary of Electricity Distribution Companies			
1	Period of Information Year of (FY) information including Date and Month (Start & End)	1 APRIL 2022 - 31 March 2023	
2	Technical Details		
(a)	Energy Input Details		
(i)	Input Energy Purchase (From Generation Source)	Million kwh	70329.40
(ii)	Net input energy (at DISCOM Periphery after adjusting the transmission losses and energy traded)	Million kwh	66160.34
(iii)	Total Energy billed (is the Net energy billed, adjusted for energy traded))	Million kwh	58708.60
(b)	Transmission and Distribution (T&D) loss Details	Million kwh	7451.75
		%	11.26%
	Collection Efficiency	%	100%
(c)	Aggregate Technical & Commercial Loss	%	11.26%

Discom D Losses

I/We undertake that the information supplied in this Document and Pro-forma is accurate to the best of my knowledge and if any of the information supplied is found to be incorrect and such information result into loss to the Central Government or State Government or any of the authority under them or any other person affected, I/we undertake to indemnify such loss.

Authorised Signatory and Seal

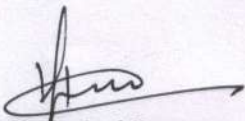
 Name of Authorised Signatory
 Name of the DISCOM:
 Full Address: Er. Hira Lal Goyal
 S.E./DSM,
 P.S.P.C.L., Patiala
 CE/EA & Enforcement

Signature:-
 Name of Energy Manager*:
 Registration Number:
 Er. Ravi Verma
 EA- 796 9
 Energy Auditor
 PSPCL, Patiala.

Seal

Form-Details of Input Infrastructure					
1	Parameters	Total	Covered during in audit	Verified by Auditor in Sample Check	Remarks (Source of data)
i	Number of circles	21	21	21	CE/Planning
ii	Number of divisions	104	104	104	CE/Planning
iii	Number of sub-divisions	508	508	508	CE/Planning
iv	Number of feeders	13148	13148	13148	Director / D
v	Number of DTs	1200300	1200300	1200300	Director / D
vi	Number of consumers	10513750	10513750	10513750	CE/Planning
2	Parameters	66kV and above	33kV	11/22kV	LT
a. i.	Number of conventional metered consumers	31	0	7511	7872441
ii	Number of consumers with 'smart' meters	0	0	114	140038
iii	Number of consumers with 'smart prepaid' meters	0	0	0	1416
iv	Number of consumers with 'AMR' meters	196	3	8831	35671
v	Number of consumers with 'non-smart prepaid' meters	4	3	475	1064582
vi	Number of unmetered consumers	0	0	0	1382434
vii	Number of total consumers	231	6	16931	10496582
b.i.	Number of conventionally metered Distribution Transformers	0	0	25943	0
ii	Number of DTs with communicable meters	1420	2	33754	0
iii	Number of unmetered DTs	0	0	1140603	0
iv	Number of total Transformers	1420	2	1200300	0
c.i.	Number of metered feeders	168	5	12975	0
ii	Number of feeders with communicable meters	168	5	12975	0
iii	Number of unmetered feeders	0	0	0	0
iv	Number of total feeders	168	5	12975	0
d.	Line length (ct km)	14289 KM,	71 Km	252006 Km	153732 Km.
e.	Length of Aerial Bunched Cables	NA	NA	NA	NA
f.	Length of Underground Cables	NA	NA	NA	NA

[Signature]
S.E./DSM,
P.S.P.C.L., Patiala
[Signature]

[Signature]
Er. Ravi Verma
EA- 7969
Energy Auditor
PSPCL, Patiala.

3	Voltage level	Particulars	MU	Reference	Remarks (Source of data)
i	66kV and above (Inter-State)	Long-Term Conventional	25172.24		Includes input energy for franchisees
		Medium Conventional (unscheduled interchange)	-441.94		value of unscheduled interchange energy is entered as the provision of the same has not provided in the performa
		Short Term Conventional	7471.95	10874.18-436.37	
		Banking	311.80		
		Long-Term Renewable energy	2691.16		
		Medium and Short-Term RE	0.00		Includes power from bilateral/ PX/ DEEP
		Captive, open access input			Any power wheeled for any purchase other than sale to DISCOM. Does not include input for franchisee.
		Sale of surplus power	-502.87		
		Quantum of inter-state transmission loss	1440.37		As confirmed by SLDC, RLDC etc
		Power procured from inter-state sources	34702.34		Based on data from Form 5
		Power at state transmission boundary	33261.97		
ii	66kV and above (Intra-State)	Long-Term Conventional	33411.30		Power procured from intra state sources at different voltage levels
		Medium Conventional	NA		
		Short Term Conventional	NA		
		Banking	NA		
		Long-Term Renewable energy	1975.30		NRSE power procured from intra state sources at 66KV and above
		Medium and Short-Term RE			
		Captive, open access input			
		Sale of surplus power			
		Quantum of intra-state transmission loss	2728.688		PSTCL Losses + PSPCL Sub transmission Losses
				Power procured from intra-state sources	35386.59
iii		Input in DISCOM wires network	65920		
iv	33 kV	Renewable Energy Procurement	10.39		
		Small capacity conventional/ biomass/ hydro plants Procurement	0.00		
		Captive, open access input	0.00		
v	11 kV	Renewable Energy Procurement	230.07		NRSE power procured from intra state sources at 11KV
		Small capacity conventional/ biomass/ hydro plants Procurement	0.00		
		Sales Migration Input			
vi	LT	Renewable Energy Procurement	101.91		Roof Top Solar Energy
		Sales Migration Input	-101.91		
vii	Energy Embedded within DISCOM wires network	Energy Embedded within DISCOM wires network	240.46		
viii	Total Energy Available/ Input	Total Energy Available/ Input	66160.34		

[Signature]
S.E./DSM,
PS.P.C.L., Patiala

[Signature]
Er. Ravi Verma
EA- 7969
Energy Auditor
PSPCL, Patiala.

4	Voltage level	Energy Sales Particulars	MU	Reference	
i	11KV/LT	DISCOM' consumers		Include sales to consumers in franchisee areas, unmetered consumers	
		Demand from open access, captive	0	Non DISCOM's sales	
		Embedded generation used		Demand from embedded generation at LT level	
		Sale at 11KV/LT level	0.00		
		Quantum of 11KV/LT level losses	0.000		
		Energy Input at 11 KV/ LT level			
ii	33 kV Level	DISCOM' consumers		Include sales to consumers in franchisee areas, unmetered consumers	
		Demand from open access, captive	0	Non DISCOM's sales	
		Embedded generation at 33 kV level used		Demand from embedded generation at 11kV level	
		Sales at 33 kV level	0.00		
		Quantum of Losses at 33 kV	0.000		
		Energy Input at 33 kV level			
iii	66/33/11 / 0.44 KV	DISCOM' consumers	58709	Include sales to consumers in franchisee areas, unmetered consumers	
		Demand from open access, captive	0	Non DISCOM's sales	
		Embedded generation at 66 kV or below level		This is DISCOM and OA demand met via energy generated at same voltage level	
		Sales at 66 kV level	58709		
		Quantum of Losses at 66 kV	7452		
		Energy Input at 66kV Level	66160		
iv	> 66 kV	DISCOM' consumers		Include sales to consumers in franchisee areas, unmetered consumers	
		Demand from open access, captive	0	Non DISCOM's sales	
		Cross border sale of energy	0		
		Sale at other DISCOMs	0		
		Banking	0		
		Energy Input at > 66kV Level	4169		
		Sales at 66kV and above (EHV)			
Total Energy Requirement			70329.40		
Total Energy Sales			58708.60		

*S.E./DSM,
P.S.P.C.L., Patiala*

Ravi
Er. Ravi Verma
EA- 7969
Energy Auditor
PSPCL, Patiala.

Energy Accounting Summary					
5	DISCOM	Input (in MU)	Sale (in MU)	Loss (in MU)	Loss %
i	LT				
ii	11KV				
iii	33 KV				
iv	66/33/11 / 0.44 KV	66160.34	58708.60	7451.74	11.26%
6	Open Access, Captive	Input (in MU)	Sale (in MU)	Loss (in MU)	
i	LT	0	0	0	
ii	11 Kv	0	0	0	
iii	33 kv	0	0	0	
iv	> 33 kv				

Loss Estimation for DISCOM	
T&D loss	11,621
D loss	7,452
T&D loss (%)	16.52%
D loss (%)	10.60%

NOTE: D losses 10.60 % are Calculated on the basis of availability of Power to PSPCL. (At Generation Sources) i.e 70329 MU and D Losses in Division Wise Losses Sheet 11.26 % are calculated by Net input energy (At DISCOM Periphery after adjusting the transmission losses and energy traded) i.e 66160 MU basis.

 (Er. Hira Lal Goyal)
 CE/EA & Enforcement

 S.E. DSW,
 P.S.P.C.L., Patiala

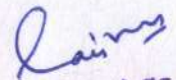
 Er. Ravi Verma
 EA- 7969
 Energy Auditor
 PSPCL, Patiala.

Details of Division Wise Losses (See note below)**																								
Division Wise Losses																								
Period From 01.04.2022 To 31.03.2023																								
S.No	Name of circle	Circle code	Name of Division	Consumer profile								Energy parameters				Losses		Commercial Parameter			AT & C loss (%)			
				Consumer category	No of connection metered (Nos)	No of connection Un-metered (Nos)	Total Number of connections (Nos)	% of number of connections	Connected Load metered (MW)	Connected Load Un-metered (MW)	Total Connected Load (MW)	% of connected load	Billed energy (MU)				T&D loss (MU)	T&D loss (%)	Billed Amount In Rs. Crore	Collected Amount in Rs. Crore		Collection Efficiency		
										Input energy (MU)	Metered energy	Unmetered/assessment energy	Total energy	% of energy consumption										
1	CITY AMRITSAR	8	DS CITY CENTER DIVN., ASR	Residential	45563		45563	71%	108.266		108.266	44%	321.03	109.75		109.747	40%	48.87	15.22%			0.00%		
				Agricultural	263	0	263	0%	1.434	0	1.434	1%		5.23	0.00	5.231	2%					0.00%		
				Commercial/Industrial-LT	18277		18277	28%	123.075		123.075	50%		123.40		123.401	45%					0.00%		
				Commercial/Industrial-HT	43		43	0%	13.989		13.989	6%		30.94		30.936	11%					0.00%		
				Others	150		150	0%	1.525		1.525	1%		2.85		2.845	1%					148.76	164.78	100.00%
				Sub-total	64296	0	64296	100%	248.289	0	248.289	100%		321.03	272.160	0.000	272.160			100%	48.87	15.22%	148.76	164.78
2	CITY AMRITSAR	8	DS CIVIL LINES TECH. DIVN.	Residential	31039		31039	48%	143.427		143.427	58%	293.06	135.95		135.953	50%	31.36	10.70%			0.00%		
				Agricultural	7	0	7	0%	0.035	0	0.035	0%		0.00	0.00	0.000	0%					0.00%		
				Commercial/Industrial-LT	10205		10205	16%	115.949		115.949	47%		115.34		115.337	42%					0.00%		
				Commercial/Industrial-HT	6		6	0%	6.681		6.681	3%		2.88		2.875	1%					0.00%		
				Others	94		94	0%	3.715		3.715	1%		7.54		7.535	3%					148.76	164.78	100.00%
				Sub-total	41351	0	41351	100%	269.807	0	269.807	100%		293.06	261.700	0.000	261.700			100%	31.36	10.70%	148.76	164.78
3	CITY AMRITSAR	8	DS DIVN. HAKIMA GATE, ASR	Residential	41585		41585	65%	89.965		89.965	36%	181.12	84.89		84.893	31%	30.26	16.71%			0.00%		
				Agricultural	14	0	14	0%	0.088	0	0.088	0%		0.00	0.00	0.000	0%					0.00%		
				Commercial/Industrial-LT	22814		22814	35%	71.475		71.475	29%		59.67		59.670	22%					0.00%		
				Commercial/Industrial-HT	7		7	0%	3.169		3.169	1%		3.71		3.708	1%					0.00%		
				Others	118		118	0%	1.067		1.067	0%		2.59		2.591	1%					148.76	164.78	100.00%
				Sub-total	64538	0	64538	100%	165.764	0	165.764	100%		181.12	150.862	0.000	150.862			100%	30.26	16.71%	148.76	164.78
4	CITY AMRITSAR	8	DS INDL. AREA TECH. DIVN.	Residential	48994		48994	75%	104.876		104.876	42%	249.54	132.72		132.717	49%	47.47	19.02%			0.00%		
				Agricultural	64	0	64	0%	0.273	0	0.273	0%		0.45	0.00	0.450	0%					0.00%		
				Commercial/Industrial-LT	13236		13236	21%	72.312		72.312	29%		64.03		64.025	24%					0.00%		
				Commercial/Industrial-HT	7		7	0%	2.732		2.732	1%		3.96		3.956	1%					0.00%		
				Others	126		126	0%	0.91		0.91	0%		0.92		0.922	0%					148.76	164.78	100.00%
				Sub-total	62427	0	62427	100%	181.103	0	181.103	100%		249.54	202.070	0.000	202.070			100%	47.47	19.02%	148.76	164.78
5	GURDASPUR	9	DS CITY DIVN. BATALA	Residential	73674		73674	115%	134.311		134.311	54%	364.72	154.53		154.529	57%	65.71	18.02%			0.00%		
				Agricultural	306	13117	13423	21%	0.934	60.57	61.504	25%		2.35	81.80	84.151	31%					0.00%		
				Commercial/Industrial-LT	13813		13813	21%	58.651		58.651	24%		44.80		44.799	16%					0.00%		
				Commercial/Industrial-HT	17		17	0%	8.476		8.476	3%		14.53		14.525	5%					0.00%		
				Others	40		40	0%	0.646		0.646	0%		1.00		1.003	0%					185.18	219.25	100.00%
				Sub-total	87850	13117	100967	100%	203.018	60.57	263.588	100%		364.72	217.205	81.802	299.008			100%	65.71	18.02%	185.18	219.25
6	GURDASPUR	9	DS CITY DIVN. PATHANKOT	Residential	116127		116127	181%	159.746		159.746	64%	495.89	203.28		203.275	75%	24.92	5.02%			0.00%		
				Agricultural	112	4648	4760	7%	1.639	17.234	18.873	8%		3.94	39.69	43.636	16%					0.00%		
				Commercial/Industrial-LT	25709		25709	40%	80.575		80.575	32%		70.86		70.860	26%					0.00%		
				Commercial/Industrial-HT	146		146	0%	71.946		71.946	29%		112.15		112.147	41%					0.00%		
				Others	64		64	0%	16.942		16.942	7%		41.06		41.057	15%					294.72	327.50	100.00%
				Sub-total	142158	4648	146806	100%	330.848	17.234	348.082	100%		495.89	431.282	39.693	470.975			100%	24.92	5.02%	294.72	327.50
7	GURDASPUR	9	DS DIVN. QADIAN	Residential	56796		56796	88%	79.753		79.753	32%	378.12	137.12		137.117	50%	72.41	19.15%			0.00%		
				Agricultural	165	15641	15806	25%	0.352	59.297	59.649	24%		0.13	136.20	136.334	50%					0.00%		
				Commercial/Industrial-LT	7045		7045	11%	16.645		16.645	7%		22.97		22.969	8%					0.00%		
				Commercial/Industrial-HT	8		8	0%	1.904		1.904	1%		9.03		9.030	3%					0.00%		
				Others	27		27	0%	0.434		0.434	0%		0.26		0.258	0%					170.92	216.03	100.00%
				Sub-total	64041	15641	79682	100%	99.088	59.297	158.385	100%		378.12	169.507	136.201	305.708			100%	72.41	19.15%	170.92	216.03

S.E.DSM,
P.S.P.C.L., Patiala

Er. Ravi Verma
EA-796 g
Energy Auditor
PSPCL, Patiala.

8	GURDASPUR	9	DS DIVN. DHARIWAL	Residential	73008		73008	114%	118.37		118.37	48%	262.15	106.59		106.594	39%	53.10	20.26%			0.00%	
				Agricultural	117	20373	20490	32%	1.07	96.171	97.241	39%		1.32	81.19	82.515	30%					0.00%	
				Commercial/Industrial-LT	8718		8718	14%	25.328		25.328	10%		16.40		16.398	6%					0.00%	
				Commercial/Industrial-HT	16		16	0%	5.33		5.33	2%		2.58		2.583	1%					0.00%	
				Others	6		6	0%	0.102		0.102	0%		0.96		0.958	0%					0.00%	
Sub-total					81865	20373	102238	100%	150.2	96.171	246.371	100%	262.15	127.857	81.192	209.049	100%	53.10	20.26%	121.30	153.82	100.00%	20%
9	GURDASPUR	9	DS DIVN. GURDASPUR	Residential	108983		108983	170%	166.226		166.226	67%	405.15	201.13		201.134	74%	61.96	15.29%			0.00%	
				Agricultural	67	18607	18674	29%	0.227	63.107	63.334	26%		0.85	72.12	72.976	27%					0.00%	
				Commercial/Industrial-LT	16411		16411	26%	49.533		49.533	20%		44.71		44.708	16%					0.00%	
				Commercial/Industrial-HT	19		19	0%	7.036		7.036	3%		8.66		8.658	3%					0.00%	
				Others	36		36	0%	5.625		5.625	2%		15.71		15.712	6%					0.00%	
Sub-total					125516	18607	144123	100%	228.647	63.107	291.794	100%	405.15	271.064	72.124	343.188	100%	61.96	15.29%	205.38	246.50	100.00%	15%
10	GURDASPUR	9	DS S/U DIVN. BATALA	Residential	95526		95526	149%	127.549		127.549	51%	481.77	172.68		172.683	63%	128.05	26.58%			0.00%	
				Agricultural	243	25577	25820	40%	0.791	109.523	110.314	44%		6.35	124.37	130.725	48%					0.00%	
				Commercial/Industrial-LT	11103		11103	17%	43.505		43.505	18%		36.49		36.485	13%					0.00%	
				Commercial/Industrial-HT	31		31	0%	9.53		9.53	4%		9.22		9.215	3%					0.00%	
				Others	56		56	0%	2.149		2.149	1%		4.62		4.615	2%					0.00%	
Sub-total					106959	25577	132536	100%	183.524	109.523	293.047	100%	481.77	229.352	124.371	353.723	100%	128.05	26.58%	200.71	244.93	100.00%	27%
11	GURDASPUR	9	DS S/U DIVN. PATHANKOT	Residential	92336		92336	144%	134.603		134.603	54%	336.29	159.57		159.571	59%	27.60	8.21%			0.00%	
				Agricultural	230	5195	5425	8%	1.67	17.603	19.273	8%		0.27	25.76	26.025	10%					0.00%	
				Commercial/Industrial-LT	17936		17936	28%	65.089		65.089	26%		61.58		61.577	23%					0.00%	
				Commercial/Industrial-HT	44		44	0%	17.624		17.624	7%		13.04		13.037	5%					0.00%	
				Others	20		20	0%	20.038		20.038	8%		48.48		48.477	18%					0.00%	
Sub-total					110566	5195	115761	100%	239.024	17.603	256.627	100%	336.29	282.929	25.758	308.687	100%	27.60	8.21%	187.07	214.55	100.00%	8%
12	SUB URBAN AMRITSAR	11	DS DIVN. JANDIALA GURU	Residential	70187		70187	109%	98.733		98.733	40%	515.83	147.84		147.838	54%	100.33	19.45%			0.00%	
				Agricultural	206	16645	16851	26%	1.06	112.094	113.154	46%		5.39	124.13	129.517	48%					0.00%	
				Commercial/Industrial-LT	8380		8380	13%	58.17		58.17	23%		60.08		60.080	22%					0.00%	
				Commercial/Industrial-HT	75		75	0%	38.227		38.227	15%		68.69		68.686	25%					0.00%	
				Others	37		37	0%	4.761		4.761	2%		9.38		9.383	3%					0.00%	
Sub-total					78885	16645	95530	100%	200.951	112.094	313.045	100%	515.83	291.379	124.125	415.504	100%	100.33	19.45%	256.54	300.04	100.00%	19%
13	SUB URBAN AMRITSAR	11	DS EAST DIVN. AMRITSAR	Residential	156582		156582	244%	380.39076		380.39076	153%	1062.70	437.06		437.057	161%	172.89	16.27%			0.00%	
				Agricultural	808	0	808	1%	3.773	0	3.773	2%		22.63	0.00	22.627	8%					0.00%	
				Commercial/Industrial-LT	26466		26466	41%	190.693276		190.693276	77%		218.44		218.441	80%					0.00%	
				Commercial/Industrial-HT	84		84	0%	71.00192		71.00192	29%		171.35		171.345	63%					0.00%	
				Others	285		285	0%	23.44124		23.44124	9%		40.33		40.334	15%					0.00%	
Sub-total					184225	0	184225	100%	669.300196	0	669.300196	100%	1062.70	889.804	0.000	889.804	100%	172.89	16.27%	575.10	632.18	100.00%	16%
14	SUB URBAN AMRITSAR	11	DS S/U DIVN. AMRITSAR	Residential	77076		77076	120%	113.169		113.169	46%	616.96	126.84		126.839	47%	191.50	31.04%			0.00%	
				Agricultural	200	19510	19710	31%	0.924	98.623	99.547	40%		7.41	119.31	126.720	47%					0.00%	
				Commercial/Industrial-LT	7590		7590	12%	54.311		54.311	22%		77.90		77.899	29%					0.00%	
				Commercial/Industrial-HT	81		81	0%	37.581		37.581	15%		90.60		90.595	33%					0.00%	
				Others	24		24	0%	1.787		1.787	1%		3.42		3.416	1%					0.00%	
Sub-total					84971	19510	104481	100%	207.772	98.623	306.395	100%	616.96	306.159	119.310	425.469	100%	191.50	31.04%	262.78	309.71	100.00%	31%
15	SUB URBAN AMRITSAR	11	DS WEST DIVN. ASR	Residential	54042		54042	84%	72.389		72.389	29%	503.76	92.60		92.599	34%	200.56	39.81%			0.00%	
				Agricultural	52	18869	18921	29%	0.249	113.869	114.118	46%		3.75	171.75	175.496	64%					0.00%	
				Commercial/Industrial-LT	5273		5273	8%	22.515		22.515	9%		20.68		20.680	8%					0.00%	
				Commercial/Industrial-HT	8		8	0%	7.47		7.47	3%		10.07		10.073	4%					0.00%	
				Others	27		27	0%	2.76		2.76	1%		4.35		4.351	2%					0.00%	
Sub-total					59402	18869	78271	100%	105.383	113.869	219.252	100%	503.76	131.448	171.751	303.199	100%	200.56	39.81%	174.37	212.50	100.00%	40%
16	SUB URBAN AMRITSAR	11	DS DIVN. AJNALA	Residential	60747		60747	94%	82.291		82.291	33%	438.32	96.62		96.618	36%	174.89	39.90%			0.00%	
				Agricultural	13	21552	21565	34%	0.052	109.033	109.085	44%		0.20	138.83	139.027	51%					0.00%	
				Commercial/Industrial-LT	5625		5625	9%	20.645		20.645	8%		20.38		20.381	7%					0.00%	
				Commercial/Industrial-HT	5		5	0%	2.254		2.254	1%		4.02		4.018	1%					0.00%	
				Others	21		21	0%	1.323		1.323	1%		3.38		3.382	1%					0.00%	
Sub-total					66411	21552	87963	100%	106.565	109.033	215.598	100%	438.32	124.598	138.828	263.426	100%	174.89	39.90%	152.01	195.86	100.00%	40%

S.E. DSM,
P.S.P.C.L., Patna
18

Er. Ravi Verma
EA- 796 9
Energy Auditor
PSPCL, Patna

17	TARN TARAN	12	DS CITY DIVN. TARN TARAN	Residential	69967		69967	109%	100.911		100.911	41%	525.26	141.21		141.210	52%	162.66	30.97%			0.00%	
				Agricultural	29	17923	17952	28%	0.152	123.728	123.88	50%		0.55	161.55	162.098	60%					0.00%	
				Commercial/Industrial-LT	9123		9123	14%	30.27		30.27	12%		33.33		33.334	12%					0.00%	
				Commercial/Industrial-HT	18		18	0%	11.129		11.129	4%		24.37		24.368	9%					0.00%	
				Others	19		19	0%	0.855		0.855	0%		1.59		1.591	1%					0.00%	
Sub-total					79156	17923	97079	100%	143.317	123.728	267.045	100%	525.26	201.049	161.552	362.601	100%	162.66	30.97%	210.70	264.82	100.00%	31%
18	TARN TARAN	12	DS DIVN. BHIKHIWIND	Residential	44438		44438	69%	65.239		65.239	26%	516.89	61.08		61.081	22%	250.91	48.54%			0.00%	
				Agricultural	0	19779	19779	31%	0	152.905	152.905	62%		0.00	181.51	181.509	67%					0.00%	
				Commercial/Industrial-LT	5220		5220	8%	17.647		17.647	7%		15.42		15.416	6%					0.00%	
				Commercial/Industrial-HT	4		4	0%	1.493		1.493	1%		2.43		2.432	1%					0.00%	
				Others	32		32	0%	1.912		1.912	1%		5.54		5.544	2%					0.00%	
Sub-total					49694	19779	69473	100%	86.291	152.905	239.196	100%	516.89	84.473	181.509	265.982	100%	250.91	48.54%	174.83	214.50	100.00%	49%
19	TARN TARAN	12	DS DIVN. PATTI	Residential	61656		61656	96%	94.427		94.427	38%	642.23	101.96		101.961	37%	273.18	42.54%			0.00%	
				Agricultural	78	20881	20959	33%	0.615	174.264	174.879	70%		8.36	229.61	237.965	87%					0.00%	
				Commercial/Industrial-LT	6889		6889	11%	23.654		23.654	10%		23.57		23.568	9%					0.00%	
				Commercial/Industrial-HT	4		4	0%	3.218		3.218	1%		5.07		5.065	2%					0.00%	
				Others	5		5	0%	0.451		0.451	0%		0.50		0.499	0%					0.00%	
Sub-total					68632	20881	89513	100%	122.365	174.264	296.629	100%	642.23	139.451	229.607	369.058	100%	273.18	42.54%	211.97	292.85	100.00%	43%
20	TARN TARAN	12	DS DIVN. RAYYA AT BEAS	Residential	84203		84203	131%	144.042		144.042	58%	462.77	179.87		179.870	66%	87.97	19.01%			0.00%	
				Agricultural	48	20337	20385	32%	0.46	130.729	131.189	53%		0.75	150.28	151.020	55%					0.00%	
				Commercial/Industrial-LT	9030		9030	14%	33.438		33.438	13%		30.95		30.946	11%					0.00%	
				Commercial/Industrial-HT	9		9	0%	2.835		2.835	1%		4.12		4.124	2%					0.00%	
				Others	15		15	0%	6.141		6.141	2%		8.84		8.841	3%					0.00%	
Sub-total					93305	20337	113642	100%	186.916	130.729	317.645	100%	462.77	224.526	150.275	374.801	100%	87.97	19.01%	219.14	268.02	100.00%	19%
21	TARN TARAN	12	DS S/U DIVN. TARN TARAN	Residential	55757		55757	34%	84.949		84.949	34%	428.95	121.67		121.669	45%	118.45	27.62%			0.00%	
				Agricultural	0	15530	15530	24%	0	115.831	115.831	47%		0.00	131.17	131.170	48%					0.00%	
				Commercial/Industrial-LT	6084		6084	9%	29.743		29.743	12%		27.59		27.589	10%					0.00%	
				Commercial/Industrial-HT	35		35	0%	49.855		49.855	20%		29.76		29.760	11%					0.00%	
				Others	12		12	0%	0.412		0.412	0%		0.30		0.304	0%					0.00%	
Sub-total					61888	15530	77418	100%	164.959	115.831	280.79	100%	428.95	179.322	131.170	310.492	100%	118.45	27.62%	182.19	227.69	100.00%	28%
22	CITY EAST LUDHIANA	13	DS CITY CEN. (SPL) DIVN. LDH	Residential	20568		20568	32%	70.191		70.191	28%	207.41	57.38		57.379	21%	4.75	2.29%			0.00%	
				Agricultural	1	0	1	0%	0.005	0	0.005	0%		0.00	0.00	0.001	0%					0.00%	
				Commercial/Industrial-LT	27755		27755	43%	159.94		159.94	64%		137.37		137.367	50%					0.00%	
				Commercial/Industrial-HT	5		5	0%	2.1		2.1	1%		3.86		3.858	1%					0.00%	
				Others	132		132	0%	2.371		2.371	1%		4.05		4.051	1%					0.00%	
Sub-total					48461	0	48461	100%	234.607	0	234.607	100%	207.41	202.656	0.000	202.656	100%	4.75	2.29%	133.43	140.50	100.00%	2%
23	CITY EAST LUDHIANA	13	DS CMC (SPL) DIVN. LDH	Residential	36152		36152	56%	96.424		96.424	39%	416.76	106.93		106.927	39%	7.64	1.83%			0.00%	
				Agricultural	0	0	0	0%	0	0	0%	0.00		0.00	0.000	0%					0.00%		
				Commercial/Industrial-LT	17240		17240	27%	175.72		175.72	71%		194.42		194.423	71%					0.00%	
				Commercial/Industrial-HT	134		134	0%	59.941		59.941	24%		93.21		93.205	34%					0.00%	
				Others	139		139	0%	8.875		8.875	4%		14.56		14.562	5%					0.00%	
Sub-total					53665	0	53665	100%	340.96	0	340.96	100%	416.76	409.117	0.000	409.117	100%	7.64	1.83%	286.52	299.71	100.00%	2%
24	CITY EAST LUDHIANA	13	DS F. POINT (SPL) DIVN. LDH	Residential	88639		88639	138%	197.811		197.811	80%	2190.61	227.92		227.917	84%	1.31	0.06%			0.00%	
				Agricultural	373	355	728	1%	1.374	2.492	3.866	2%		0.31	1.75	2.067	1%					0.00%	
				Commercial/Industrial-LT	19383		19383	30%	270.884		270.884	109%		298.59		298.588	110%					0.00%	
				Commercial/Industrial-HT	905		905	1%	671.746		671.746	271%		1655.83		1655.832	608%					0.00%	
				Others	264		264	0%	2.493		2.493	1%		4.89		4.890	2%					0.00%	
Sub-total					109564	355	109919	100%	1144.308	2.492	1146.8	100%	2190.61	2187.541	1.753	2189.294	100%	1.31	0.06%	1560.98	1520.18	97.39%	3%
25	CITY EAST LUDHIANA	13	SUNDER NAGAR LDH	Residential	77176		77176	120%	135.297		135.297	54%	757.35	178.71		178.708	66%	40.27	5.32%			0.00%	
				Agricultural	19	2909	2928	5%	0.047	18.675	18.722	8%		0.04	16.25	16.294	6%					0.00%	
				Commercial/Industrial-LT	24185		24185	38%	281.308		281.308	113%		342.03		342.034	126%					0.00%	
				Commercial/Industrial-HT	222		222	0%	96.117		96.117	39%		178.19		178.187	65%					0.00%	
				Others	162		162	0%	0.848		0.848	0%		1.85		1.851	1%					0.00%	
Sub-total					101764	2909	104673	100%	513.617	18.675	532.292	100%	757.35	700.819	16.255	717.074	100%	40.27	5.32%	469.97	501.69	100.00%	5%

S.E./DSM,
P.S.P.C.L., Patiala

Er. Ravi Verma
EA-7969
Energy Auditor
PSPCL, Pa

26	CITY WEST LUDHIANA	14	DS AGAR. NGR. (SPL) DIVN.	Residential	94667		94667	147%	414.698		414.698	167%	608.86	359.35		359.350	132%	42.57	6.99%				0.00%
				Agricultural	176	1463	1639	3%	0.793	10.035	10.828	4%		0.76	10.42	11.179	4%						0.00%
				Commercial/Industrial-LT	17376		17376	27%	148.946		148.946	60%		156.34		156.343	57%						0.00%
				Commercial/Industrial-HT	22		22	0%	14.673		14.673	6%		32.64		32.639	12%						0.00%
				Others	207		207	0%	8.493		8.493	3%		6.78		6.784	2%						0.00%
Sub-total					112448	1463	113911	100%	587.603	10.035	597.638	100%	608.86	555.871	10.424	566.295	100%	42.57	6.99%	419.34	450.47	100.00%	7%
27	CITY WEST LUDHIANA	14	WEST LUDHIANA	Residential	52943		52943	82%	209.917		209.917	85%	632.38	204.29		204.290	75%	25.58	4.04%				0.00%
				Agricultural	63	677	740	1%	0.236	3.216	3.452	1%		0.04	3.12	3.161	1%						0.00%
				Commercial/Industrial-LT	18252		18252	28%	233.07		233.07	94%		235.20		235.199	86%						0.00%
				Commercial/Industrial-HT	250		250	0%	81.234		81.234	33%		135.89		135.886	50%						0.00%
				Others	181		181	0%	8.027		8.027	3%		28.27		28.271	10%						0.00%
Sub-total					71689	677	72366	100%	532.484	3.216	535.7	100%	632.38	603.682	3.125	606.807	100%	25.58	4.04%	422.05	424.92	100.00%	4%
28	CITY WEST LUDHIANA	14	DS ESTATE (SPL) DIVN.LDH	Residential	57227		57227	89%	102.788		102.788	41%	1812.92	127.92		127.919	47%	91.75	5.06%				0.00%
				Agricultural	197	1986	2183	3%	1.199	9.347	10.546	4%		0.69	12.51	13.204	5%						0.00%
				Commercial/Industrial-LT	23325		23325	36%	361.514		361.514	146%		310.36		310.357	114%						0.00%
				Commercial/Industrial-HT	607		607	1%	636.129		636.129	256%		1262.62		1262.618	464%						0.00%
				Others	159		159	0%	3.673		3.673	1%		7.07		7.073	3%						0.00%
Sub-total					81515	1986	83501	100%	1105.303	9.347	1114.65	100%	1812.92	1708.660	12.511	1721.171	100%	91.75	5.06%	1322.23	1376.48	100.00%	5%
29	CITY WEST LUDHIANA	14	ANTA NAGAR SPL LD	Residential	68320		68320	106%	131.924		131.924	53%	408.28	160.08		160.076	59%	32.47	7.95%				0.00%
				Agricultural	0	0	0	0%	0	0	0	0%		0.00	0.00	0.001	0%						0.00%
				Commercial/Industrial-LT	22382		22382	35%	219.228		219.228	88%		178.74		178.738	66%						0.00%
				Commercial/Industrial-HT	45		45	0%	24.068		24.068	10%		34.03		34.029	13%						0.00%
				Others	137		137	0%	3.609		3.609	1%		2.97		2.970	1%						0.00%
Sub-total					90884	0	90884	100%	378.829	0	378.829	100%	408.28	375.814	0.000	375.814	100%	32.47	7.95%	258.06	285.78	100.00%	8%
30	CITY WEST LUDHIANA	14	DS MODEL TOWN (SPL) DIVN.LDH	Residential	70066		70066	130%	322.848		322.848	130%	446.78	287.33		287.331	106%	38.16	8.54%				0.00%
				Agricultural	18	444	462	1%	0.085	2.543	2.628	1%		-0.01	3.03	3.020	1%						0.00%
				Commercial/Industrial-LT	16484		16484	26%	110.537		110.537	45%		104.40		104.399	38%						0.00%
				Commercial/Industrial-HT	15		15	0%	6.429		6.429	3%		5.16		5.164	2%						0.00%
				Others	174		174	0%	5.048		5.048	2%		8.70		8.701	3%						0.00%
Sub-total					86757	444	87201	100%	444.947	2.543	447.49	100%	446.78	405.581	3.034	408.615	100%	38.16	8.54%	288.53	317.53	100.00%	9%
31	KHANNA	15	DS (SPL) DIVN. M/GOBI ND GARH	Residential	28940		28940	45%	70.836		70.836	29%	2918.25	81.54		81.536	30%	-28.10	-0.96%				0.00%
				Agricultural	0	1480	1480	2%	0	11.248	11.248	5%		0.22	17.98	18.195	7%						0.00%
				Commercial/Industrial-LT	9034		9034	14%	71.57		71.57	29%		54.19		54.189	20%						0.00%
				Commercial/Industrial-HT	387		387	1%	741.212		741.212	299%		2788.47		2788.470	1025%						0.00%
				Others	9		9	0%	1.471		1.471	1%		3.95		3.954	1%						0.00%
Sub-total					38370	1480	39850	100%	885.089	11.248	896.337	100%	2918.25	2928.365	17.979	2946.344	100%	-28.10	-0.96%	2076.81	2037.46	98.11%	1%
32	KHANNA	15	DS DIVN. AMLOH	Residential	46916		46916	73%	66.613		66.613	27%	853.79	105.06		105.058	39%	48.13	5.64%				0.00%
				Agricultural	9	13918	13927	22%	0.067	141.332	141.399	57%		2.08	145.00	147.080	54%						0.00%
				Commercial/Industrial-LT	5797		5797	9%	34.704		34.704	14%		31.06		31.059	11%						0.00%
				Commercial/Industrial-HT	78		78	0%	153.513		153.513	62%		522.27		522.265	192%						0.00%
				Others	16		16	0%	0.078		0.078	0%		0.20		0.198	0%						0.00%
Sub-total					52816	13918	66734	100%	254.975	141.332	396.307	100%	853.79	660.660	145.000	805.660	100%	48.13	5.64%	534.78	568.09	100.00%	6%
33	KHANNA	15	DS DIVN. DORAH	Residential	44523		44523	69%	72.855		72.855	29%	675.80	98.65		98.647	36%	27.32	4.04%				0.00%
				Agricultural	0	11148	11148	17%	0	69.342	69.342	28%		0.05	87.01	87.057	32%						0.00%
				Commercial/Industrial-LT	6639		6639	10%	34.62		34.62	14%		34.23		34.229	13%						0.00%
				Commercial/Industrial-HT	116		116	0%	174.989		174.989	70%		427.05		427.047	157%						0.00%
				Others	32		32	0%	0.566		0.566	0%		1.50		1.499	1%						0.00%
Sub-total					51310	11148	62458	100%	283.03	69.342	352.372	100%	675.80	561.470	87.009	648.480	100%	27.32	4.04%	428.20	451.01	100.00%	4%
34	KHANNA	15	DS DIVN. KHANNA	Residential	86993		86993	135%	168.013		168.013	68%	865.46	199.46		199.457	73%	71.18	8.22%				0.00%
				Agricultural	0	15172	15172	24%	0	128.31	128.31	52%		0.67	154.60	155.270	57%						0.00%
				Commercial/Industrial-LT	15235		15235	24%	86.092		86.092	35%		75.46		75.465	28%						0.00%
				Commercial/Industrial-HT	226		226	0%	140.548		140.548	57%		361.75		361.748	133%						0.00%
				Others	41		41	0%	1.417		1.417	1%		2.34		2.344	1%						0.00%
Sub-total					102495	15172	117667	100%	396.07	128.31	524.38	100%	865.46	639.680	154.604	794.284	100%	71.18	8.22%	528.35	577.74	100.00%	8%

S.E./DSM,
B.S.P.C.L., Patiala

Er. Ravi Verma
EA- 7969
Energy Auditor
BSPCL, P.

35	KHANNA	15	DS DIVN. SIRHIND	Residential	74422		74422	116%	128.828		128.828	52%	744.72	170.65		170.654	63%	58.13	7.81%			0.00%
				Agricultural	0	15931	15931	25%	0	140.456	140.456	57%		2.93	172.52	175.452	64%					0.00%
				Commercial/Industrial-LT	12843		12843	20%	65.956		65.956	27%		65.56		65.557	24%					0.00%
				Commercial/Industrial-HT	79		79	0%	86.466		86.466	35%		272.88		272.879	100%					0.00%
				Others	21		21	0%	0.565		0.565	0%		2.04		2.041	1%					0.00%
				Sub-total				87365	15931	103296	100%	281.815		140.456	422.271	100%	744.72			514.058	172.525	686.583
36	SUB URBAN LUDHIANA	17	DS DIVN. ADDA DAKHA	Residential	56471		56471	88%	109.701		109.701	44%	438.81	131.42		131.418	48%	27.60	6.29%			0.00%
				Agricultural	0	13518	13518	21%	0	108.181	108.181	44%		0.25	131.42	131.671	48%					0.00%
				Commercial/Industrial-LT	9280		9280	14%	47.925		47.925	19%		42.09		42.095	15%					0.00%
				Commercial/Industrial-HT	127		127	0%	50.717		50.717	20%		91.56		91.555	34%					0.00%
				Others	19		19	0%	4.966		4.966	2%		14.48		14.478	5%					0.00%
				Sub-total				65897	13518	79415	100%	213.309		108.181	321.49	100%	438.81			279.799	131.418	411.217
37	SUB URBAN LUDHIANA	17	DS DIVN. AHMEDGARH	Residential	42432		42432	66%	80.204		80.204	32%	327.91	91.63		91.630	34%	29.32	8.94%			0.00%
				Agricultural	0	10244	10244	16%	0	87.707	87.707	35%		0.12	94.70	94.813	35%					0.00%
				Commercial/Industrial-LT	7432		7432	12%	36.167		36.167	15%		30.30		30.300	11%					0.00%
				Commercial/Industrial-HT	96		96	0%	39.62		39.62	16%		81.20		81.196	30%					0.00%
				Others	7		7	0%	0.161		0.161	0%		0.66		0.656	0%					0.00%
				Sub-total				49967	10244	60211	100%	156.152		87.707	243.859	100%	327.91			203.899	94.696	298.595
38	SUB URBAN LUDHIANA	17	DS DIVN. JAGRAON	Residential	58713		58713	70%	113.179		113.179	36%	420.72	139.65		139.653	38%	51.57	12.26%			0.00%
				Agricultural	48	14567	14615	17%	0.267	113.916	114.183	36%		0.37	133.94	134.301	36%					0.00%
				Commercial/Industrial-LT	10080		10080	12%	47.94		47.94	15%		42.57		42.568	12%					0.00%
				Commercial/Industrial-HT	151		151	0%	39.473		39.473	12%		50.07		50.071	14%					0.00%
				Others	12		12	0%	2.454		2.454	1%		2.56		2.557	1%					0.00%
				Sub-total				69004	14567	83571	100%	203.313		113.916	317.229	100%	420.72			235.214	133.936	369.150
39	SUB URBAN LUDHIANA	17	DS DIVN. RAIKOT	Residential	58138		58138	70%	93.905		93.905	28%	466.64	129.43		129.426	31%	50.95	10.92%			0.00%
				Agricultural	18	17104	17122	21%	0.128	187.722	187.85	56%		0.29	237.37	237.662	57%					0.00%
				Commercial/Industrial-LT	7329		7329	9%	30.548		30.548	9%		28.65		28.655	7%					0.00%
				Commercial/Industrial-HT	80		80	0%	23.073		23.073	7%		19.49		19.493	5%					0.00%
				Others	3		3	0%	0.118		0.118	0%		0.45		0.451	0%					0.00%
				Sub-total				65568	17104	82672	100%	335.494			335.494	100%	466.64			178.317	237.370	415.687
40	SUB URBAN LUDHIANA	17	DS S/U DIVN. LALTON KALAN	Residential	62477		62477	74%	138.087		138.087	39%	469.42	164.35		165.639	2834%	31.53	6.72%			0.00%
				Agricultural	27	12906	12933	15%	0.156	106.376	106.532	30%		0.28	131.42	131.694	2253%					0.00%
				Commercial/Industrial-LT	9191		9191	11%	66.934		66.934	19%		54.00		53.997	924%					0.00%
				Commercial/Industrial-HT	69		69	0%	44.316		44.316	12%		86.30		86.296	1476%					0.00%
				Others	13		13	0%	0.195		0.195	0%		0.27		0.265	5%					0.00%
				Sub-total				71777	12906	84683	100%	249.688		106.376	356.064	100%	469.42			306.472	131.419	437.891
41	HOSHIARPUR	23	DS CITY DIVN. HSP	Residential	91603		91603	75%	173.027		173.027	50%	516.85	164.35		164.345	35%	50.15	9.70%			0.00%
				Agricultural	307	5327	5634	5%	1.825	45.404	47.229	14%		0.05	62.88	62.925	13%					0.00%
				Commercial/Industrial-LT	24419		24419	20%	80.675		80.675	23%		84.54		84.537	18%					0.00%
				Commercial/Industrial-HT	23		23	0%	44.139		44.139	13%		150.79		150.789	32%					0.00%
				Others	95		95	0%	2.479		2.479	1%		4.10		4.100	1%					0.00%
				Sub-total				116447	5327	121774	100%	302.145		45.404	347.549	100%	516.85			403.817	62.879	466.696
42	HOSHIARPUR	23	DS DIVN. BHOGPUR	Residential	74372		74372	73%	128.775		128.775	45%	376.70	132.44		132.444	39%	33.83	8.98%			0.00%
				Agricultural	176	15263	15439	15%	0.611	110.069	110.68	38%		0.04	134.47	134.515	39%					0.00%
				Commercial/Industrial-LT	11833		11833	12%	35.769		35.769	12%		36.23		36.234	11%					0.00%
				Commercial/Industrial-HT	17		17	0%	13.173		13.173	5%		38.91		38.910	11%					0.00%
				Others	39		39	0%	0.386		0.386	0%		0.77		0.766	0%					0.00%
				Sub-total				86437	15263	101700	100%	178.714		110.069	288.783	100%	376.70			208.396	134.473	342.869
43	HOSHIARPUR	23	DS DIVN. DASUYA	Residential	77212		77212	77%	139.47		139.47	60%	301.52	143.90		143.903	3638%	31.72	10.52%			0.00%
				Agricultural	36	11185	11221	11%	0.114	54.962	55.076	24%		0.69	79.45	80.142	2026%					0.00%
				Commercial/Industrial-LT	12208		12208	12%	33.788		33.788	15%		38.96		38.958	985%					0.00%
				Commercial/Industrial-HT	8		8	0%	2.498		2.498	1%		3.86		3.860	98%					0.00%
				Others	43		43	0%	1.599		1.599	1%		2.94		2.938	74%					0.00%
				Sub-total				89507	11185	100692	100%	177.469		54.962	232.431	100%	301.52			190.347	79.454	269.802

S.E./DSM,
P.S.P.C.L., Patiala

Er. Ravi Verma
EA-7969
Energy Auditor
PSPCL, Pat

44	HOSHIARPUR	23	DS DIVN. MAHILPUR	Residential	72758		72758	79%	101.06		101.06	43%	387.63	112.11		112.105	41%	114.69	29.59%			0.00%	
				Agricultural	62	8994	8956	10%	0.345	88.366	38%	88.711		38%	0.62	112.45	113.062			41%	0.00%		
				Commercial/Industrial-LT	10762		10762	12%	29.471		13%	29.471		13%	36.22		36.222			13%	0.00%		
				Commercial/Industrial-HT	15		15	0%	16.139		7%	16.139		7%	11.35		11.353			4%	0.00%		
				Others	5		5	0%	0.11		0%	0.11		0%	0.19		0.191			0%	0.00%		
Sub-total					83602	8994	92596	100%	147.125	88.366	235.491	100%	387.63	160.487	112.446	272.933	100%	114.69	29.59%	157.02	196.91	100.00%	30%
45	HOSHIARPUR	23	DS DIVN. MUKERIAN	Residential	97734		97734	78%	158.398		158.398	64%	284.89	163.08		163.082	58%	5.01	1.76%			0.00%	
				Agricultural	45	8483	8528	7%	0.115	31.713	13%	31.828		13%	0.07	63.77	63.837			23%	0.00%		
				Commercial/Industrial-LT	18339		18339	15%	45.076		18%	45.076		18%	38.29		38.289			14%	0.00%		
				Commercial/Industrial-HT	46		46	0%	13.041		5%	13.041		5%	12.78		12.784			5%	0.00%		
				Others	9		9	0%	0.73		0%	0.73		0%	1.89		1.892			1%	0.00%		
Sub-total					116173	8483	124656	100%	217.36	31.713	249.073	100%	284.89	216.114	63.770	279.884	100%	5.01	1.76%	160.96	193.69	100.00%	2%
46	HOSHIARPUR	23	DS S/U DIVN. HSP	Residential	71967		71967	78%	89.282		89.282	23%	728.80	117.04		117.041	17%	33.22				0.00%	
				Agricultural	19	10536	10555	11%	0.221	94.331	24%	94.552		24%	0.00	118.55	118.555			17%	0.00%		
				Commercial/Industrial-LT	10181		10181	11%	47.716		12%	47.716		12%	47.56		47.556			7%	0.00%		
				Commercial/Industrial-HT	77		77	0%	154.778		40%	154.778		40%	412.35		412.346			59%	0.00%		
				Others	3		3	0%	0.027		0%	0.027		0%	0.09		0.085			0%	0.00%		
Sub-total					82247	10536	92783	100%	292.024	94.331	386.355	100%	728.80	577.028	118.555	695.582	100%	33.22	0.00%	435.26	489.37	100.00%	0%
47	JALANDHAR	24	DS Divn. Cantt, Jalandhar	Residential	106682		106682	80%	234.35		234.35	54%	564.34	263.60		263.605	50%	41.34	7.32%			0.00%	
				Agricultural	152	7322	7474	6%	0.449	57.443	13%	57.892		13%	0.75	73.11	73.859			14%	0.00%		
				Commercial/Industrial-LT	18996		18996	14%	94.905		22%	94.905		22%	91.09		91.088			17%	0.00%		
				Commercial/Industrial-HT	42		42	0%	12.568		3%	12.568		3%	23.12		23.125			4%	0.00%		
				Others	149		149	0%	33.364		8%	33.364		8%	71.32		71.323			14%	0.00%		
Sub-total					126021	7322	133343	100%	375.636	57.443	433.079	100%	564.34	449.887	73.113	523.000	100%	41.34	7.32%	333.61	367.28	100.00%	7%
48	JALANDHAR	24	DS Divn. East, Jalandhar	Residential	73942		73942	72%	156.147		156.147	21%	968.12	172.73		172.731	19%	48.78	5.04%			0.00%	
				Agricultural	95	3409	3504	3%	0.263	23.482	3%	23.745		3%	0.19	31.33	31.516			3%	0.00%		
				Commercial/Industrial-LT	24075		24075	24%	215.759		29%	215.759		29%	167.82		167.820			18%	0.00%		
				Commercial/Industrial-HT	490		490	0%	338.491		46%	338.491		46%	542.22		542.219			59%	0.00%		
				Others	120		120	0%	4.662		1%	4.662		1%	5.05		5.052			1%	0.00%		
Sub-total					98722	3409	102131	100%	715.322	23.482	738.804	100%	968.12	888.008	31.330	919.338	100%	48.78	5.04%	657.49	681.82	100.00%	5%
49	JALANDHAR	24	DS Divn. Model Town, Jalandhar	Residential	118148		118148	79%	340.642		340.642	51%	793.45	346.22		346.216	48%	67.25	8.48%			0.00%	
				Agricultural	39	5659	5698	4%	0.105	55.594	8%	55.699		8%	0.34	60.91	61.243			8%	0.00%		
				Commercial/Industrial-LT	25281		25281	17%	183.966		27%	183.966		27%	195.03		195.028			27%	0.00%		
				Commercial/Industrial-HT	211		211	0%	87.004		13%	87.004		13%	118.27		118.272			16%	0.00%		
				Others	230		230	0%	3.946		1%	3.946		1%	5.44		5.442			1%	0.00%		
Sub-total					143909	5659	149568	100%	615.663	55.594	671.257	100%	793.45	665.293	60.908	726.201	100%	67.25	8.48%	456.34	500.98	100.00%	8%
50	JALANDHAR	24	DS DIVN. PHAGWARA	Residential	90290		90290	76%	185.827		185.827	45%	486.09	195.26		195.259	43%	35.86	7.38%			0.00%	
				Agricultural	146	9532	9678	8%	1.174	82.683	20%	83.857		20%	0.88	116.51	117.385			26%	0.00%		
				Commercial/Industrial-LT	18070		18070	15%	87.919		21%	87.919		21%	76.98		76.980			17%	0.00%		
				Commercial/Industrial-HT	51		51	0%	35.165		9%	35.165		9%	35.33		35.332			8%	0.00%		
				Others	119		119	0%	19.707		5%	19.707		5%	25.27		25.271			6%	0.00%		
Sub-total					108676	9532	118208	100%	329.792	82.683	412.475	100%	486.09	333.718	116.509	450.227	100%	35.86	7.38%	282.03	320.00	100.00%	7%
51	JALANDHAR	24	DS Divn. West, Jalandhar	Residential	78191		78191	72%	239.11		239.11	47%	576.45	232.41		232.414	44%	48.55	8.42%			0.00%	
				Agricultural	87	556	643	1%	0.386	4.814	1%	5.2		1%	0.22	6.22	6.434			1%	0.00%		
				Commercial/Industrial-LT	28781		28781	27%	199.934		39%	199.934		39%	187.56		187.564			36%	0.00%		
				Commercial/Industrial-HT	129		129	0%	62.336		12%	62.336		12%	86.31		86.305			16%	0.00%		
				Others	183		183	0%	7.574		1%	7.574		1%	15.18		15.181			3%	0.00%		
Sub-total					107371	556	107927	100%	509.34	4.814	514.154	100%	576.45	521.682	6.216	527.898	100%	48.55	8.42%	368.53	388.58	100.00%	8%
52	KAPURTHALA	25	DS CITY DIVN. KAPURTHALA	Residential	71523		71523	71%	118.079		118.079	33%	489.26	158.59		158.586	37%	60.17	12.30%			0.00%	
				Agricultural	42	19190	19232	19%	0.661	155.764	44%	156.425		44%	2.97	174.26	177.231			41%	0.00%		
				Commercial/Industrial-LT	10448		10448	10%	40.73		12%	40.73		12%	39.43		39.427			9%	0.00%		
				Commercial/Industrial-HT	124		124	0%	38.144		11%	38.144		11%	52.81		52.808			12%	0.00%		
				Others	6		6	0%	0.325		0%	0.325		0%	1.05		1.046			0%	0.00%		
Sub-total					82143	19190	101333	100%	197.939	155.764	353.703	100%	489.26	254.835	174.263	429.098	100%	60.17	12.30%	258.87	309.01	100.00%	12%

S.E./DSM,
P.S.P.C.L., Patiala

Rainis
Er. Ravi Verma
EA-7969
Energy Auditor
PSPCL, Patiala.

53	KAPURTHALA	25	DS CITY DIVN. NAKODAR	Residential	74099		74099	69%	122.311		122.311	35%	129.46		129.456	33%			0.00%			
				Agricultural	0	21412	21412	20%	0	173.356	173.356	50%	0.17	201.25	201.413	51%			0.00%			
				Commercial/Industrial-LT	11127		11127	10%	35.419		35.419	10%	35.37		35.374	9%			0.00%			
				Commercial/Industrial-HT	69		69	0%	17.276		17.276	5%	28.11		28.112	7%			0.00%			
				Others	32		32	0%	0.528		0.528	0%	0.70		0.701	0%			0.00%			
Sub-total				85327	21412	106739	100%	175.534	173.356	348.89	100%	475.73	193.809	201.247	395.056	100%	80.67	16.96%	233.41	290.35	100.00%	17%
54	KAPURTHALA	25	DS DIVN. KARTARPUR	Residential	58013		58013	71%	119.153		119.153	43%	125.90		125.899	43%			0.00%			
				Agricultural	39	14777	14816	18%	0.78	87.036	87.816	31%	1.66	91.90	93.565	32%			0.00%			
				Commercial/Industrial-LT	9067		9067	11%	33.676		33.676	12%	36.80		36.802	13%			0.00%			
				Commercial/Industrial-HT	53		53	0%	36.208		36.208	13%	30.90		30.896	11%			0.00%			
				Others	30		30	0%	2.814		2.814	1%	5.83		5.829	2%			0.00%			
Sub-total				67202	14777	81979	100%	192.631	87.036	279.667	100%	316.82	201.087	91.904	292.991	100%	23.83	7.52%	176.54	207.62	100.00%	8%
55	KAPURTHALA	25	DS S/U DIVN. KAPURTHALA	Residential	73732		73732	70%	150.154		150.154	47%	178.03		178.029	48%			0.00%			
				Agricultural	200	18746	18946	18%	0.51	103.9	104.41	33%	0.09	103.75	103.839	28%			0.00%			
				Commercial/Industrial-LT	12445		12445	12%	46.36358		46.36358	14%	44.57		44.573	12%			0.00%			
				Commercial/Industrial-HT	22		22	0%	8.95		8.95	3%	31.89		31.892	9%			0.00%			
				Others	40		40	0%	10.433		10.433	3%	14.31		14.306	4%			0.00%			
Sub-total				86439	18746	105185	100%	216.41058	103.9	320.31058	100%	412.44	268.885	103.754	372.638	100%	39.80	9.65%	221.26	254.18	100.00%	10%
56	KAPURTHALA	25	DS S/U DIVN. NAKODAR	Residential	84862		84862	73%	154.888		154.888	42%	162.78		162.777	36%			0.00%			
				Agricultural	49	17266	17315	15%	0.157	150.688	150.845	41%	1.45	218.81	220.258	48%			0.00%			
				Commercial/Industrial-LT	14717		14717	13%	48.164		48.164	13%	43.17		43.170	9%			0.00%			
				Commercial/Industrial-HT	33		33	0%	13.655		13.655	4%	31.28		31.280	7%			0.00%			
				Others	22		22	0%	0.428		0.428	0%	0.99		0.990	0%			0.00%			
Sub-total				99683	17266	116949	100%	217.292	150.688	367.98	100%	517.24	239.669	218.806	458.475	100%	58.77	11.36%	267.13	324.90	100.00%	11%
57	NAWANSHAHR	26	DS DIVN. BANGA	Residential	69543		69543	77%	121.262		121.262	51%	110.22		110.215	42%			0.00%			
				Agricultural	14	11427	11441	13%	0.055	82.132	82.187	34%	0.04	119.67	119.711	45%			0.00%			
				Commercial/Industrial-LT	9129		9129	10%	29.379		29.379	12%	26.10		26.100	10%			0.00%			
				Commercial/Industrial-HT	16		16	0%	5.002		5.002	2%	5.85		5.845	2%			0.00%			
				Others	9		9	0%	1.014		1.014	0%	1.36		1.355	1%			0.00%			
Sub-total				78711	11427	90138	100%	217.292	82.132	302.30	100%	302.30	143.559	119.667	263.226	100%	39.08	12.93%	153.44	190.20	100.00%	13%
58	NAWANSHAHR	26	DS DIVN. GARHSHANKAR	Residential	100155		100155	81%	134.401		134.401	50%	155.33		155.325	41%			0.00%			
				Agricultural	31	10512	10543	9%	0.106	88.258	88.364	33%	0.09	168.15	168.234	44%			0.00%			
				Commercial/Industrial-LT	12501		12501	10%	42.829		42.829	16%	48.15		48.146	13%			0.00%			
				Commercial/Industrial-HT	22		22	0%	5.395		5.395	2%	6.11		6.113	2%			0.00%			
				Others	7		7	0%	0.263		0.263	0%	0.50		0.502	0%			0.00%			
Sub-total				112716	10512	123228	100%	182.994	88.258	271.252	100%	479.90	210.174	168.146	378.320	100%	101.58	21.17%	214.43	265.05	100.00%	21%
59	NAWANSHAHR	26	DS DIVN. GORAYA	Residential	75547		75547	75%	133.311		133.311	39%	128.41		128.405	30%			0.00%			
				Agricultural	204	12758	12962	13%	1.089	95.144	96.233	28%	1.80	143.01	144.810	33%			0.00%			
				Commercial/Industrial-LT	12771		12771	13%	53.086		53.086	16%	56.70		56.705	13%			0.00%			
				Commercial/Industrial-HT	61		61	0%	55.091		55.091	16%	102.13		102.126	24%			0.00%			
				Others	11		11	0%	0.506		0.506	0%	1.77		1.767	0%			0.00%			
Sub-total				88594	12758	101352	100%	249.083	95.144	338.227	100%	482.32	290.806	143.007	433.812	100%	48.51	10.06%	266.09	310.12	100.00%	10%
60	NAWANSHAHR	26	DS DIVN. NAWANSHAHR	Residential	73130		73130	74%	133.92		133.92	50%	130.87		130.874	41%			0.00%			
				Agricultural	130	11730	11860	12%	0.718	66.402	67.12	25%	26.18	84.37	110.550	35%			0.00%			
				Commercial/Industrial-LT	13568		13568	14%	52.561		52.561	20%	47.03		47.025	15%			0.00%			
				Commercial/Industrial-HT	37		37	0%	13.864		13.864	5%	26.90		26.902	8%			0.00%			
				Others	14		14	0%	1.283		1.283	0%	1.68		1.681	1%			0.00%			
Sub-total				86879	11730	98609	100%	202.346	66.402	268.748	100%	321.96	232.665	84.367	317.032	100%	4.93	1.53%	190.87	228.89	100.00%	2%
61	BARNALA	78	DS CITY DIVN. BARNALA	Residential	76340		76340	68%	142.513		142.513	26%	173.58		173.582	26%			0.00%			
				Agricultural	25	23194	23219	21%	0.152	273.674	273.826	51%	0.57	350.77	351.339	53%			0.00%			
				Commercial/Industrial-LT	13218		13218	12%	68.785		68.785	13%	65.91		65.910	10%			0.00%			
				Commercial/Industrial-HT	81		81	0%	54.098		54.098	10%	61.14		61.135	9%			0.00%			
				Others	10		10	0%	2.274		2.274	0%	6.64		6.638	1%			0.00%			
Sub-total				89674	23194	112868	100%	267.822	273.674	541.496	100%	808.27	307.832	350.772	658.604	100%	149.67	18.52%	398.77	488.22	100.00%	19%

S.E./DSM,
P.S.P.C.L., Patiala

Er. Ravi Verma
EA-7969
Energy A
PCL,

62	BARNALA	78	DS DIVN. DHURI	Residential	67094		67094	68%	111.279		111.279	24%	670.99	148.40		148.400	26%	96.46	14.38%			0.00%	
				Agricultural	21	19512	19533	20%	0.162	241.956	242.118	52%		0.56	300.66	301.220	52%					0.00%	
				Commercial/Industrial-LT	11366		11366	12%	62.73472		62.73472	13%		55.81		55.806	10%					0.00%	
				Commercial/Industrial-HT	121		121	0%	53.252		53.252	11%		67.91		67.909	12%					0.00%	
				Others	11		11	0%	0.556		0.556	0%		1.20		1.196	0%					0.00%	
Sub-total					78613	19512	98125	100%	227.98372	241.956	469.93972	100%	670.99	273.867	300.664	574.531	100%	96.46	14.38%	344.31	419.52	100.00%	14%
63	BARNALA	78	DS DIVN. MALERKOTLA	Residential	89626		89626	72%	145.025187		145.025187	26%	863.72	196.48		196.484	24%	57.31	6.64%			0.00%	
				Agricultural	38	18379	18417	15%	0.21027	208.5533425	208.7636125	38%		0.30	248.86	249.166	31%					0.00%	
				Commercial/Industrial-LT	16747		16747	13%	87.820763		87.820763	16%		79.01		79.009	10%					0.00%	
				Commercial/Industrial-HT	109		109	0%	103.640501		103.640501	19%		271.60		271.598	34%					0.00%	
				Others	42		42	0%	5.5275		5.5275	1%		10.15		10.153	1%					0.00%	
Sub-total					106562	18379	124941	100%	342.224221	208.5533425	550.7775635	100%	863.72	557.348	248.862	806.410	100%	57.31	6.64%	496.93	573.56	100.00%	7%
64	BARNALA	78	DS S/U DIVN. BARNALA	Residential	66987		66987	69%	111.755		111.755	19%	790.52	141.72		141.717	23%	160.97	20.36%			0.00%	
				Agricultural	20	20304	20324	21%	0.207	255.157	255.364	42%		0.00	335.18	335.180	53%					0.00%	
				Commercial/Industrial-LT	9757		9757	10%	63.988		63.988	11%		62.19		62.188	10%					0.00%	
				Commercial/Industrial-HT	132		132	0%	165.23		165.23	27%		83.67		83.668	13%					0.00%	
				Others	45		45	0%	4.86		4.86	1%		6.80		6.797	1%					0.00%	
Sub-total					76941	20304	97245	100%	346.04	255.157	601.197	100%	790.52	294.370	335.180	629.590	100%	160.97	20.36%	395.99	483.85	100.00%	20%
65	MOHALI	30	DS DIVN. LALRU	Residential	75934		75934	81%	136.425		136.425	17%	1498.72	155.81		155.813	11%	69.52	4.64%			0.00%	
				Agricultural	5	5234	5239	6%	0.023	58.319	58.342	7%		0.12	83.25	83.365	6%					0.00%	
				Commercial/Industrial-LT	11466		11466	12%	111.353		111.353	14%		145.92		145.923	10%					0.00%	
				Commercial/Industrial-HT	395		395	0%	470.418		470.418	60%		1038.03		1038.030	73%					0.00%	
				Others	167		167	0%	3.146		3.146	0%		6.06		6.062	0%					0.00%	
Sub-total					87967	5234	93201	100%	721.365	58.319	779.684	100%	1498.72	1345.947	83.246	1429.193	100%	69.52	4.64%	902.22	937.92	100.00%	5%
66	MOHALI	30	DS DIVN. ZIRAKPUR	Residential	125241		125241	83%	499.88318		499.88318	64%	723.04	343.17		343.169	54%	81.74	11.31%			0.00%	
				Agricultural	7	5475	5482	4%	0.063	56.034	56.097	7%		3.28	55.77	59.047	9%					0.00%	
				Commercial/Industrial-LT	19359		19359	13%	192.974		192.974	25%		204.24		204.239	32%					0.00%	
				Commercial/Industrial-HT	28		28	0%	22.474		22.474	3%		27.19		27.190	4%					0.00%	
				Others	172		172	0%	3.948		3.948	1%		7.65		7.651	1%					0.00%	
Sub-total					144807	5475	150282	100%	719.34218	56.034	775.37618	100%	723.04	585.530	55.766	641.297	100%	81.74	11.31%	404.53	473.79	100.00%	11%
67	MOHALI	30	S SPL. DIVN. MOHA	Residential	148807		148807	88%	639.673		639.673	51%	1400.88	556.75		556.746	42%	83.97	5.99%			0.00%	
				Agricultural	4	2626	2630	2%	0.075	21.472	21.547	2%		0.09	40.90	40.991	3%					0.00%	
				Commercial/Industrial-LT	16294		16294	10%	367.762		367.762	29%		387.81		387.808	29%					0.00%	
				Commercial/Industrial-HT	259		259	0%	183.074		183.074	15%		288.82		288.824	22%					0.00%	
				Others	266		266	0%	39.032		39.032	3%		42.54		42.536	3%					0.00%	
Sub-total					165630	2626	168256	100%	1251.088		1251.088	100%	1400.88	1276.001	40.904	1316.905	100%	83.97	5.99%	914.87	984.04	100.00%	6%
68	PATIALA	31	DS Divn. Model Town, Patiala	Residential	55114		55114	81%	193.656		193.656	69%	339.80	174.91		174.911	58%	40.50	11.92%			0.00%	
				Agricultural	32	0	32	0%	0.186	0	0.186	0%		0.30	0.00	0.296	0%					0.00%	
				Commercial/Industrial-LT	12921		12921	19%	64.062		64.062	23%		64.15		64.148	21%					0.00%	
				Commercial/Industrial-HT	3		3	0%	0.922		0.922	0%		0.71		0.711	0%					0.00%	
				Others	97		97	0%	22.871		22.871	8%		59.24		59.237	20%					0.00%	
Sub-total					68167	0	68167	100%	281.697	0	281.697	100%	339.80	299.303	0.000	299.303	100%	40.50	11.92%	225.14	249.09	100.00%	12%
69	PATIALA	31	DS DIVN. NABHA	Residential	69754		69754	69%	130.307		130.307	30%	565.28	163.69		163.685	32%	59.73	10.57%			0.00%	
				Agricultural	29	17523	17552	17%	0.235	197.606	197.841	46%		0.76	230.42	231.177	46%					0.00%	
				Commercial/Industrial-LT	13108		13108	13%	69.574		69.574	16%		59.32		59.318	12%					0.00%	
				Commercial/Industrial-HT	61		61	0%	30.832		30.832	7%		47.29		47.291	9%					0.00%	
				Others	26		26	0%	1.58		1.58	0%		4.08		4.079	1%					0.00%	
Sub-total					82978	17523	100501	100%	232.528	197.606	430.134	100%	565.28	275.132	230.418	505.550	100%	59.73	10.57%	308.79	369.94	100.00%	11%
70	PATIALA	31	DS DIVN. RAJPURA	Residential	87119		87119	77%	153.296		153.296	29%	858.30	185.68		185.682	24%	77.12	8.99%			0.00%	
				Agricultural	28	9280	9308	8%	0.179	97.693	97.872	18%		0.10	121.11	121.212	16%					0.00%	
				Commercial/Industrial-LT	16671		16671	15%	94.423		94.423	18%		81.37		81.371	10%					0.00%	
				Commercial/Industrial-HT	140		140	0%	187.868		187.868	35%		389.77		389.771	50%					0.00%	
				Others	56		56	0%	2.555		2.555	0%		3.14		3.139	0%					0.00%	
Sub-total					104014	9280	113294	100%	438.321	97.693	536.014	100%	858.30	660.067	121.108	781.175	100%	77.12	8.99%	511.05	560.48	100.00%	9%

S.E./DSM,
P.S.P.C.L., Patiala

Er. Ravi Verma
EA-796
Energy Au...
PSPCL, P:

71	PATIALA	31	DS DIVN. SAMANA	Residential	52994		52994	69%	74.46		74.46	19%	116.72		116.717	18%			0.00%				
				Agricultural	48	15068	15116	20%	0.338	185.478	185.816	48%	0.56	223.54	34%					0.00%			
				Commercial/Industrial-LT	8061		8061	11%	49.231		49.231	13%	49.57		49.567	8%					0.00%		
				Commercial/Industrial-HT	114		114	0%	73.571		73.571	19%	265.23		265.226	40%					0.00%		
				Others	8		8	0%	0.159		0.159	0%	0.55		0.553	0%				408.83	456.55	100.00%	
Sub-total					61225	15068	76293	100%	197.759	185.478	383.237	100%	766.58	432.624	223.536	656.160	100%	110.42	14.40%	408.83	456.55	100.00%	14%
72	PATIALA	31	DS EAST DIVN PATIALA	Residential	70920		70920	73%	99.313		99.313	24%	149.78		149.784	27%			0.00%				
				Agricultural	68	18127	18195	19%	0.654	229.82	230.474	56%	1.74	253.76	46%					0.00%			
				Commercial/Industrial-LT	8286		8286	9%	44.429		44.429	11%	41.77		41.770	8%					0.00%		
				Commercial/Industrial-HT	47		47	0%	32.542		32.542	8%	92.87		92.868	17%					0.00%		
				Others	19		19	0%	5.344		5.344	1%	14.39		14.388	3%				334.81	406.63	100.00%	
Sub-total					79340	18127	97467	100%	182.282	229.82	412.102	100%	645.22	300.533	253.761	554.314	100%	90.91	14.09%	334.81	406.63	100.00%	14%
73	PATIALA	31	DS S/U DIVN PATIALA	Residential	82424		82424	76%	155.152		155.152	36%	182.69		182.689	34%			0.00%				
				Agricultural	92	15880	15972	15%	0.689	166.386	167.075	39%	1.05	200.89	38%					0.00%			
				Commercial/Industrial-LT	9674		9674	9%	57.888		57.888	14%	50.73		50.727	10%					0.00%		
				Commercial/Industrial-HT	35		35	0%	46.528		46.528	11%	91.80		91.801	17%					0.00%		
				Others	69		69	0%	1.716		1.716	0%	2.49		2.492	0%				340.35	387.84	100.00%	
Sub-total					92294	15880	108174	100%	261.973	166.386	428.359	100%	611.57	328.760	200.886	529.646	100%	81.92	13.40%	340.35	387.84	100.00%	13%
74	PATIALA	31	DS WEST DIVN PATIALA	Residential	66205		66205	79%	188.909		188.909	55%	198.68		198.677	60%			0.00%				
				Agricultural	153	0	153	0%	1.052	0	1.052	0%	1.18	0.00	1.175	0%					0.00%		
				Commercial/Industrial-LT	16906		16906	20%	111.81		111.81	32%	103.33		103.327	31%					0.00%		
				Commercial/Industrial-HT	39		39	0%	41.488		41.488	12%	23.95		23.949	7%					0.00%		
				Others	117		117	0%	1.06		1.06	0%	2.52		2.520	1%				222.29	250.02	100.00%	
Sub-total					83420	0	83420	100%	344.319	0	344.319	100%	364.25	329.648	0.000	329.648	100%	34.61	9.50%	222.29	250.02	100.00%	10%
75	ROPAR	32	DS DIVN. KHARAR	Residential	147485		147485	83%	398.946		398.946	55%	376.80		376.802	43%			0.00%				
				Agricultural	292	12249	12541	7%	2.156	116.301	118.457	16%	0.48	143.92	144.405	17%					0.00%		
				Commercial/Industrial-LT	18281		18281	10%	124.587		124.587	17%	149.18		149.179	17%					0.00%		
				Commercial/Industrial-HT	112		112	0%	77.05		77.05	11%	194.76		194.755	22%					0.00%		
				Others	40		40	0%	2.93		2.93	0%	4.57		4.569	1%				519.25	633.74	100.00%	
Sub-total					166210	12249	178459	100%	605.669	116.301	721.97	100%	944.23	725.785	143.925	869.710	100%	74.52	7.85%	519.25	633.74	100.00%	8%
76	ROPAR	32	DS DIVN. ANANDPUR SAHIB	Residential	99248		99248	384%	149.94552		149.94552	38%	156.42		156.419	23%			0.00%				
				Agricultural	0	5825	5825	5%	0	26.759	26.759	7%	0.00	79.47	79.467	12%					0.00%		
				Commercial/Industrial-LT	14968		14968	12%	54.879		54.879	14%	55.68		55.676	8%					0.00%		
				Commercial/Industrial-HT	120		120	0%	159.048		159.048	41%	379.07		379.069	56%					0.00%		
				Others	120		120	0%	1.563		1.563	0%	2.80		2.795	0%				442.15	482.37	100.00%	
Sub-total					114456	5825	120281	100%	365.43552	26.759	392.19452	100%	663.49	593.959	79.467	673.425	100%	-9.94	-1.50%	442.15	482.37	100.00%	-1%
77	ROPAR	32	DS DIVN. ROPAR	Residential	76942		76942	76%	147.256		147.256	34%	156.89		156.893	36%			0.00%				
				Agricultural	152	10487	10639	11%	0.501	64.231	64.732	25%	0.61	84.50	85.114	20%					0.00%		
				Commercial/Industrial-LT	13178		13178	13%	59.463		59.463	14%	57.06		57.062	13%					0.00%		
				Commercial/Industrial-HT	33		33	0%	152.318		152.318	35%	298.51		298.507	69%					0.00%		
				Others	77		77	0%	7.17		7.17	2%	11.46		11.456	3%				388.48	413.44	100.00%	
Sub-total					90382	10487	100869	100%	366.708	64.231	430.939	100%	668.03	524.529	84.503	609.032	100%	59.00	8.83%	388.48	413.44	100.00%	9%
78	ROPAR	32	DS DIVN. SAMRALA	Residential	87263		87263	70%	148.063		148.063	20%	171.03		171.027	11%			0.00%				
				Agricultural	128	23207	23335	19%	0.503	111.268	111.771	15%	0.52	138.75	139.266	9%					0.00%		
				Commercial/Industrial-LT	13112		13112	11%	64.829		64.829	9%	59.61		59.614	4%					0.00%		
				Commercial/Industrial-HT	320		320	0%	396.967		396.967	55%	1122.11		1122.106	75%					0.00%		
				Others	33		33	0%	0.759		0.759	0%	0.88		0.884	0%				1007.56	1084.44	100.00%	
Sub-total					100856	23207	124063	100%	611.121	111.268	722.389	100%	1573.01	1354.152	138.745	1492.897	100%	80.12	5.09%	1007.56	1084.44	100.00%	5%
79	SANGRUR	33	DS CITY DIVN. SUNAM	Residential	67101		67101	67%	115.593		115.593	25%	153.40		153.402	27%			0.00%				
				Agricultural	52	21308	21360	21%	0.461	265.891	266.352	57%	1.43	300.73	302.154	53%					0.00%		
				Commercial/Industrial-LT	11503		11503	11%	56.827		56.827	12%	58.61		58.611	10%					0.00%		
				Commercial/Industrial-HT	94		94	0%	30.842		30.842	7%	58.69		58.694	10%					0.00%		
				Others	10		10	0%	1.504		1.504	0%	1.46		1.464	0%				339.83	412.51	100.00%	
Sub-total					78760	21308	100068	100%	205.227	265.891	471.118	100%	701.84	273.597	300.728	574.325	100%	127.51	18.17%	339.83	412.51	100.00%	18%

S.E./DSM.
P.S.P.C.L., Patiala

Ravi
Er. Ravi Verma
EA- 7969
Energy Auditor
PSPCL, Patiala.

80	SANGRUR	33	DS DIVN. DIRBA	Residential	43638		43638	67%	61.483		61.483	19%	456.52	96.15		96.153	24%	52.23	11.44%			0.00%	
				Agricultural	0	16259	16259	25%	0	208.72	208.72	66%		0.00	243.92	243.923	60%					0.00%	
				Commercial/Industrial-LT	4901		4901	8%	27.92		27.92	9%		29.58		29.583	7%					0.00%	
				Commercial/Industrial-HT	62		62	0%	18.988		18.988	6%		34.57		34.574	9%					0.00%	
				Others	2		2	0%	0.015		0.015	0%		0.06		0.061	0%					0.00%	
Sub-total					48603	16259	64862	100%	108.406	208.72	317.126	100%	456.52	160.371	243.923	404.294	100%	52.23	11.44%	236.03	292.17	100.00%	11%
81	SANGRUR	33	DS DIVN. PATRAN	Residential	55490		55490	70%	74.341		74.341	21%	659.31	108.67		108.667	23%	178.40	27.06%			0.00%	
				Agricultural	15	15194	15209	19%	0.123	218.393	218.516	62%		0.52	270.53	271.046	56%					0.00%	
				Commercial/Industrial-LT	8280		8280	10%	36.54		36.54	10%		39.38		39.382	8%					0.00%	
				Commercial/Industrial-HT	63		63	0%	24.505		24.505	7%		61.37		61.368	13%					0.00%	
				Others	4		4	0%	0.223		0.223	0%		0.45		0.449	0%					0.00%	
Sub-total					63852	15194	79046	100%	135.732	218.393	354.125	100%	659.31	210.384	270.528	480.912	100%	178.40	27.06%	286.62	352.36	100.00%	27%
82	SANGRUR	33	DS DIVN. SANGRUR	Residential	68295		68295	71%	136.274		136.274	29%	753.71	179.99		179.985	27%	80.91	10.73%			0.00%	
				Agricultural	130	14244	14374	15%	0.919	182.132	183.051	39%		2.57	221.97	224.542	33%					0.00%	
				Commercial/Industrial-LT	12849		12849	13%	78.039		78.039	16%		78.80		78.796	12%					0.00%	
				Commercial/Industrial-HT	115		115	0%	74.814		74.814	16%		184.79		184.787	27%					0.00%	
				Others	26		26	0%	3.00612		3.00612	1%		4.69		4.694	1%					0.00%	
Sub-total					81415	14244	95659	100%	293.05212	182.132	475.18412	100%	753.71	450.830	221.974	672.804	100%	80.91	10.73%	415.34	482.14	100.00%	11%
83	SANGRUR	33	DS S/U DIVN. SUNAM (Lehragaga)	Residential	54890		54890	67%	77.662		77.662	21%	621.12	106.93		106.930	23%	149.63	24.09%			0.00%	
				Agricultural	0	19161	19161	23%	0	241.678	241.678	65%		0.00	307.16	307.155	65%					0.00%	
				Commercial/Industrial-LT	7619		7619	9%	35.492		35.492	10%		32.68		32.678	7%					0.00%	
				Commercial/Industrial-HT	66		66	0%	14.354		14.354	4%		24.10		24.102	5%					0.00%	
				Others	10		10	0%	0.182		0.182	0%		0.62		0.619	0%					0.00%	
Sub-total					62585	19161	81746	100%	127.69	241.678	369.368	100%	621.12	164.329	307.155	471.484	100%	149.63	24.09%	275.60	344.36	100.00%	24%
84	BATHINDA	40	DS CITY DIVN. BATHINDA	Residential	141904		141904	77%	333.119		333.119	40%	1239.60	412.86		412.858	37%	110.84	8.94%			0.00%	
				Agricultural	81	14847	14928	8%	0.568	104.154	104.722	13%		1.03	148.63	149.661	13%					0.00%	
				Commercial/Industrial-LT	26752		26752	15%	167.909		167.909	20%		165.32		165.322	15%					0.00%	
				Commercial/Industrial-HT	179		179	0%	178.001		178.001	22%		322.98		322.981	29%					0.00%	
				Others	273		273	0%	41.519		41.519	5%		77.94		77.940	7%					0.00%	
Sub-total					169189	14847	184036	100%	721.116	104.154	825.27	100%	1239.60	980.128	148.634	1128.762	100%	110.84	8.94%	749.02	830.38	100.00%	9%
85	BATHINDA	40	DS DIVN. BHAGTA BHAI KA	Residential	46710		46710	64%	65.563		65.563	21%	588.86	87.83		87.830	20%	160.03	27.18%			0.00%	
				Agricultural	2	20586	20588	28%	0.019	211.086	211.105	67%		0.05	302.04	302.085	70%					0.00%	
				Commercial/Industrial-LT	5028		5028	7%	22.605		22.605	7%		20.16		20.164	5%					0.00%	
				Commercial/Industrial-HT	98		98	0%	17.343		17.343	5%		18.45		18.450	4%					0.00%	
				Others	17		17	0%	0.057		0.057	0%		0.30		0.304	0%					0.00%	
Sub-total					51855	20586	72441	100%	105.587	211.086	316.673	100%	588.86	126.798	302.035	428.833	100%	160.03	27.18%	253.31	319.87	100.00%	27%
86	BATHINDA	40	DS DIVN. BUDHLADA	Residential	75812		75812	71%	100.443		100.443	24%	644.35	168.00		168.004	30%	88.26	13.70%			0.00%	
				Agricultural	23	20993	21016	20%	0.231	243.304	243.535	58%		0.93	295.46	296.387	53%					0.00%	
				Commercial/Industrial-LT	10478		10478	10%	52.262		52.262	12%		50.39		50.391	9%					0.00%	
				Commercial/Industrial-HT	104		104	0%	23.968		23.968	6%		40.17		40.169	7%					0.00%	
				Others	11		11	0%	0.357		0.357	0%		1.14		1.137	0%					0.00%	
Sub-total					86428	20993	107421	100%	177.261	243.304	420.565	100%	644.35	260.626	295.462	556.088	100%	88.26	13.70%	348.78	414.51	100.00%	14%
87	BATHINDA	40	DS DIVN. MANSI	Residential	106970		106970	74%	148.776		148.776	32%	706.61	226.89		226.890	38%	110.19	15.59%			0.00%	
				Agricultural	9	20990	20999	15%	0.035	203.396	203.431	44%		0.01	256.42	256.433	43%					0.00%	
				Commercial/Industrial-LT	15703		15703	11%	77.508		77.508	17%		66.99		66.990	11%					0.00%	
				Commercial/Industrial-HT	130		130	0%	36.901		36.901	8%		45.10		45.099	8%					0.00%	
				Others	5		5	0%	0.318		0.318	0%		1.01		1.007	0%					0.00%	
Sub-total					122817	20990	143807	100%	263.538	203.396	466.934	100%	706.61	339.998	256.421	596.420	100%	110.19	15.59%	360.98	439.01	100.00%	16%
88	BATHINDA	40	DS DIVN. MAUR	Residential	101381		101381	73%	130.725		130.725	19%	1341.79	231.32		231.317	19%	114.34	8.52%			0.00%	
				Agricultural	137	24656	24793	18%	1.438	193.623	195.061	28%		4.17	262.72	266.893	22%					0.00%	
				Commercial/Industrial-LT	11853		11853	9%	52.461		52.461	8%		55.65		55.650	5%					0.00%	
				Commercial/Industrial-HT	160		160	0%	307.288		307.288	45%		662.14		662.136	54%					0.00%	
				Others	14		14	0%	4.939		4.939	1%		11.46		11.456	1%					0.00%	
Sub-total					113545	24656	138201	100%	496.851	193.623	690.474	100%	1341.79	964.730	262.721	1227.451	100%	114.34	8.52%	813.35	909.72	100.00%	9%

S.E./DSM,
P.S.P.C.L., Patiala

Er. Ravi Verma
EA- 7969
Energy Auditor
PSPCL, Pa

89	BATHINDA	40	DS DIVN. RAMPURA PHUL	Residential	56338		56338	68%	102.152		102.152	28%	649.47	124.22		124.224	26%	167.58	25.80%			0.00%	26%
				Agricultural	446	14795	15241	19%	3.683	155.271	158.954	43%		15.49	201.14	216.632	45%					0.00%	
				Commercial/Industrial-LT	10597		10597	13%	58.487		58.487	16%		51.23		51.231	11%					0.00%	
				Commercial/Industrial-HT	110		110	0%	44.242		44.242	12%		82.44		82.439	17%					0.00%	
				Others	35		35	0%	3.492		3.492	1%		7.36		7.364	2%					0.00%	
Sub-total					67526	14795	82321	100%	212.056	155.271	367.327	100%	649.47	280.749	201.141	481.890	100%	167.58	25.80%	338.34	372.33	100.00%	
90	FARIDKOT	41	DS CITY DIVN. MOGA	Residential	90249		90249	68%	159.401		159.401	30%	781.26	218.74		218.742	34%	137.87	17.65%			0.00%	18%
				Agricultural	57	26344	26401	20%	0.166	266.732	266.898	50%		0.72	302.44	303.156	47%					0.00%	
				Commercial/Industrial-LT	15783		15783	12%	78.507		78.507	15%		77.71		77.705	12%					0.00%	
				Commercial/Industrial-HT	105		105	0%	29.711		29.711	6%		40.37		40.366	6%					0.00%	
				Others	54		54	0%	2.715		2.715	1%		3.42		3.415	1%					0.00%	
Sub-total					106248	26344	132592	100%	270.5	266.732	537.232	100%	781.26	340.944	302.440	643.384	100%	137.87	17.65%	384.11	474.34	100.00%	
91	FARIDKOT	41	DS DIVN. BAGHAPURANA	Residential	70496		70496	67%	111.999		111.999	23%	799.42	140.50		140.501	24%	213.92	26.76%			0.00%	27%
				Agricultural	154	24836	24990	24%	1.12	285.929	287.049	60%		4.97	332.98	337.956	58%					0.00%	
				Commercial/Industrial-LT	9536		9536	9%	39.283		39.283	8%		37.77		37.773	6%					0.00%	
				Commercial/Industrial-HT	138		138	0%	39.878		39.878	8%		68.80		68.798	12%					0.00%	
				Others	3		3	0%	0.24		0.24	0%		0.48		0.476	0%					0.00%	
Sub-total					80327	24836	105163	100%	192.52	285.929	478.449	100%	799.42	252.521	332.983	585.504	100%	213.92	26.76%	354.92	428.67	100.00%	
92	FARIDKOT	41	DS DIVN. FARIDKOT	Residential	72442		72442	70%	123.003		123.003	41%	428.19	177.49		177.491	51%	77.32	18.06%			0.00%	18%
				Agricultural	88	21518	21606	21%	0.302	106.76	107.062	35%		0.82	89.14	89.960	26%					0.00%	
				Commercial/Industrial-LT	9894		9894	10%	47.526		47.526	16%		44.04		44.038	13%					0.00%	
				Commercial/Industrial-HT	45		45	0%	15.995		15.995	5%		23.34		23.335	7%					0.00%	
				Others	27		27	0%	8.997		8.997	3%		16.04		16.042	5%					0.00%	
Sub-total					82496	21518	104014	100%	195.823	106.76	302.583	100%	428.19	261.727	89.139	350.866	100%	77.32	18.06%	222.60	259.22	100.00%	
93	FARIDKOT	41	DS DIVN. KOTKAPUR	Residential	94104		94104	71%	154.604		154.604	33%	661.10	225.71		225.706	39%	81.94	12.40%			0.00%	12%
				Agricultural	80	23662	23742	18%	0.41	207.468	207.878	44%		1.40	236.81	238.211	41%					0.00%	
				Commercial/Industrial-LT	14446		14446	11%	64.101		64.101	14%		55.13		55.134	10%					0.00%	
				Commercial/Industrial-HT	129		129	0%	40.994		40.994	9%		58.81		58.805	10%					0.00%	
				Others	34		34	0%	0.715		0.715	0%		1.30		1.298	0%					0.00%	
Sub-total					108793	23662	132455	100%	260.824	207.468	468.292	100%	661.10	342.340	236.814	579.154	100%	81.94	12.40%	351.64	421.68	100.00%	
94	FARIDKOT	41	DS S/U DIVN. MOGA	Residential	66073		66073	70%	132.824		132.824	30%	649.84	167.13		167.125	28%	57.44	8.84%			0.00%	9%
				Agricultural	33	17821	17854	19%	0.189	190.323	190.512	44%		0.27	280.56	280.829	47%					0.00%	
				Commercial/Industrial-LT	10546		10546	11%	56.618		56.618	13%		52.36		52.363	9%					0.00%	
				Commercial/Industrial-HT	136		136	0%	56.337		56.337	13%		91.22		91.220	15%					0.00%	
				Others	20		20	0%	0.646		0.646	0%		0.86		0.861	0%					0.00%	
Sub-total					76808	17821	94629	100%	246.614	190.323	436.937	100%	649.84	311.838	280.560	592.398	100%	57.44	8.84%	360.50	431.42	100.00%	
95	FEROZPUR	42	DS CITY DIVN. FEROZEPUR	Residential	66433		66433	69%	105.959		105.959	34%	507.11	150.65		150.647	40%	131.28	25.89%			0.00%	26%
				Agricultural	25	21066	21091	22%	0.091	140.052	140.143	45%		0.34	132.43	132.773	35%					0.00%	
				Commercial/Industrial-LT	9151		9151	9%	44.205		44.205	14%		43.41		43.414	12%					0.00%	
				Commercial/Industrial-HT	35		35	0%	19.133		19.133	6%		40.52		40.520	11%					0.00%	
				Others	33		33	0%	3.5		3.5	1%		8.47		8.473	2%					0.00%	
Sub-total					75677	21066	96743	100%	172.888	140.052	312.94	100%	507.11	243.394	132.433	375.827	100%	131.28	25.89%	234.77	273.96	100.00%	
96	FEROZPUR	42	DS DIVN. JALALABAD	Residential	88382		88382	69%	107.217		107.217	31%	690.11	165.40		165.400	35%	215.20	31.18%			0.00%	31%
				Agricultural	3	28187	28190	22%	0.015	153.703	153.718	45%		0.04	196.40	196.448	41%					0.00%	
				Commercial/Industrial-LT	10923		10923	9%	41.312		41.312	12%		35.69		35.691	8%					0.00%	
				Commercial/Industrial-HT	79		79	0%	39.546		39.546	12%		74.02		74.022	16%					0.00%	
				Others	31		31	0%	1.879		1.879	1%		3.35		3.350	1%					0.00%	
Sub-total					99418	28187	127605	100%	189.969	153.703	343.672	100%	690.11	278.506	196.405	474.911	100%	215.20	31.18%	280.96	348.50	100.00%	
97	FEROZPUR	42	DS DIVN. ZIRA	Residential	68573		68573	62%	101.604		101.604	20%	790.12	134.89		134.891	27%	288.64	36.53%			0.00%	37%
				Agricultural	31	31898	31929	29%	0.214	326.74	326.954	65%		0.38	286.25	286.622	57%					0.00%	
				Commercial/Industrial-LT	9043		9043	8%	45.79		45.79	9%		45.03		45.026	9%					0.00%	
				Commercial/Industrial-HT	111		111	0%	28.574		28.574	6%		33.18		33.177	7%					0.00%	
				Others	62		62	0%	0.706		0.706	0%		1.76		1.762	0%					0.00%	
Sub-total					77820	31898	109718	100%	176.888	326.74	503.628	100%	790.12	215.231	286.247	501.478	100%	288.64	36.53%	300.60	382.62	100.00%	

S.E./DSM,
P.S.P.C.L., Patiala

Er. Ravi Verma
EA- 7969
Energy Auditor
PSPCL, Pat

98	FEROZPUR	42	DS S/U DIVN. FEROZEPUR	Residential	53529		53529	66%	67.123		67.123	32%	400.44	103.92		103.918	38%	127.72	31.89%			0.00%	
				Agricultural	24	18812	18836	23%	0.083	93.039	45%	93.122			0.00%								
				Commercial/Industrial-LT	8204		8204	10%	27.479		13%	27.479			0.00%								
				Commercial/Industrial-HT	14		14	0%	3.752		2%	3.752			0.00%								
				Others	39		39	0%	16.793		8%	16.793			0.00%								
Sub-total					61810	18812	80622	100%	115.23	93.039	208.269	100%	400.44	171.842	100.882	272.724	100%	127.72	31.89%	166.94	190.48	100.00%	32%
99	MUKATSAR	43	DS DIVN. ABOHAR	Residential	101106		101106	83%	142.548		142.548	57%	440.55	195.93		195.934	64%	132.85	30.16%			0.00%	
				Agricultural	56	6941	6997	6%	0.232	29.432	12%	29.664			0.00%								
				Commercial/Industrial-LT	14141		14141	12%	60.948		24%	60.948			0.00%								
				Commercial/Industrial-HT	48		48	0%	15.522		6%	15.522			0.00%								
				Others	11		11	0%	2.655		1%	2.655			0.00%								
Sub-total					115362	6941	122303	100%	221.905	29.432	251.337	100%	440.55	279.432	28.259	307.691	100%	132.85	30.16%	213.10	238.27	100.00%	30%
100	MUKATSAR	43	DS DIVN. BADAL	Residential	33089		33089	67%	46.078		46.078	32%	254.33	72.67		72.666	38%	64.43	25.33%			0.00%	
				Agricultural	4	13248	13252	27%	0.026	61.74	42%	61.766			0.00%								
				Commercial/Industrial-LT	3198		3198	6%	18.723		13%	18.723			0.00%								
				Commercial/Industrial-HT	25		25	0%	19.333		13%	19.333			0.00%								
				Others	3		3	0%	0.195		0%	0.195			0.00%								
Sub-total					36319	13248	49567	100%	84.355	61.74	146.095	100%	254.33	119.409	70.486	189.895	100%	64.43	25.33%	121.11	143.77	100.00%	25%
101	MUKATSAR	43	DS DIVN. FAZILKA	Residential	78288		78288	69%	99.594		99.594	38%	411.70	160.65		160.647	47%	66.88	16.25%			0.00%	
				Agricultural	37	23108	23145	21%	0.117	102.585	39%	102.702			0.00%								
				Commercial/Industrial-LT	11244		11244	10%	41.802		16%	41.802			0.00%								
				Commercial/Industrial-HT	34		34	0%	14.629		6%	14.629			0.00%								
				Others	19		19	0%	2.95		1%	2.95			0.00%								
Sub-total					89622	23108	112730	100%	159.092	102.585	261.677	100%	411.70	230.547	114.370	344.818	100%	66.88	16.25%	205.29	249.28	100.00%	16%
102	MUKATSAR	43	DS DIVN. GIDDARBAHA	Residential	50730		50730	69%	80.791		80.791	40%	325.54	123.42		123.418	51%	83.24	25.57%			0.00%	
				Agricultural	0	16311	16311	22%	0	76.589	38%	76.589			0.00%								
				Commercial/Industrial-LT	6544		6544	9%	32.127		16%	32.127			0.00%								
				Commercial/Industrial-HT	50		50	0%	10.517		5%	10.517			0.00%								
				Others	2		2	0%	0.124		0%	0.124			0.00%								
Sub-total					57326	16311	73637	100%	129.559	76.589	206.148	100%	325.54	168.260	74.042	242.302	100%	83.24	25.57%	143.41	173.45	100.00%	26%
103	MUKATSAR	43	DS DIVN. MALOUT	Residential	72676		72676	69%	102.785		102.785	38%	458.89	154.25		154.253	52%	162.04	35.31%			0.00%	
				Agricultural	26	21974	22000	21%	0.172	99.589	37%	99.761			0.00%								
				Commercial/Industrial-LT	10045		10045	10%	50.332		19%	50.332			0.00%								
				Commercial/Industrial-HT	57		57	0%	14.1		5%	14.1			0.00%								
				Others	16		16	0%	0.268		0%	0.268			0.00%								
Sub-total					82820	21974	104794	100%	167.657	99.589	267.246	100%	458.89	221.770	75.080	296.850	100%	162.04	35.31%	235.65	273.83	100.00%	35%
104	MUKATSAR	43	DS DIVN. MUKTSAR	Residential	90578		90578	68%	141.41		141.41	40%	514.50	206.24		206.242	49%	93.10	18.09%			0.00%	
				Agricultural	11	29215	29226	22%	0.027	109.49	31%	109.517			0.00%								
				Commercial/Industrial-LT	13395		13395	10%	54.848		15%	54.848			0.00%								
				Commercial/Industrial-HT	112		112	0%	51.545		14%	51.545			0.00%								
				Others	5		5	0%	0.342		0%	0.342			0.00%								
Sub-total					104101	29215	133316	100%	248.172	109.49	357.662	100%	514.50	333.038	88.366	421.404	100%	93.10	18.09%	256.74	301.95	100.00%	18%
105			Theft Units, Short Assesment, Unbilled	Residential	0	0	0	#DIV/0!	0	0	0	#DIV/0!			0.00	0.00	0.00	0%	-163.09	0.00%	0.00	0.00	0.00%
				Agricultural	0	0	0	#DIV/0!	0	0	0	#DIV/0!			0.00	0.00	0.00	0%			0.00	0.00	0.00%
				Commercial/Industrial-LT	0	0	0	#DIV/0!	0	0	0	#DIV/0!			0.00	211.830	211.830	130%			0.00	0.00	0.00%
				Commercial/Industrial-HT	0	0	0	#DIV/0!	0	0	0	#DIV/0!			0.00	112.490	112.490	69%			0.00	0.00	0.00%
				Others	0	0	0	#DIV/0!	0	0	0	#DIV/0!			0.00	-161.230	-161.230	-99%			0.00	0.00	0.00%
Sub-total					0	0	0	100%	0	0	0	100%	0.00	0.00	163.090	163.090	100%	-163.09	0.00%	0.00	0.00	0.00%	100%
106			Misc.Adjustme nt to match with Audited Sale as taken	Residential	0	0	0	#DIV/0!	0	0	0	#DIV/0!		0.00	0.00	0.00	0.00	0%	-1002.41	0.00%	0.00	0.00	0.00%
				Agricultural	0	0	0	#DIV/0!	0	0	0	#DIV/0!			0.00	0.00	0.00	0%			0.00	0.00	0.00%
				Commercial/Industrial-LT	0	0	0	#DIV/0!	0	0	0	#DIV/0!			0.00	0.00	0.00	0%			0.00	0.00	0.00%
				Commercial/Industrial-HT	0	0	0	#DIV/0!	0	0	0	#DIV/0!			0.00	0.00	0.00	0%			0.00	0.00	0.00%
				Others	0	0	0	#DIV/0!	0	0	0	#DIV/0!			0.00	0.00	0.00	0%			0.00	0.00	0.00%
Sub-total					0	0	0	100%	0	0	0	100%	0.00	1002.410	0.000	1002.410	100%	-1002.41	0.00%	0.00	0.00	0.00%	100%

S.E./DSM,
P.B.P.C.L., Patiala

Er. Ravi Verma
EA-7969
Energy Auditor
PSPCL, Patiala

107	Residential	0	0	0	#DIV/0!	0	0	0	#DIV/0!	0.00	0.000	0.000	0.000	#DIV/0!	0.00	0.00%	0.00	0.00	0.00%	
	Agricultural	0	0	0	#DIV/0!	0	0	0	#DIV/0!		0.000	0.000	0.000	#DIV/0!			0.00	0.00	0.00%	
	Commercial/Industrial-LT	0	0	0	#DIV/0!	0	0	0	#DIV/0!		0.000	0.000	0.000	#DIV/0!			0.00	0.00	0.00%	
	Commercial/Industrial-HT	0	0	0	#DIV/0!	0	0	0	#DIV/0!		0.000	0.000	0.000	#DIV/0!			0.00	0.00	0.00%	
	Others	0	0	0	#DIV/0!	0	0	0	#DIV/0!		0.000	0.000	0.000	#DIV/0!			0.00	0.00	0.00%	
Sub-total		0	0	0	100%	0	0	0	100%	0.00	0.000	0.000	0.000	100%	0.00	0.00%	0.00	0.00	0.00%	100%
108	Residential	0	0	0	#DIV/0!	0	0	0	#DIV/0!	0.00	0.000	0.000	0.000	#DIV/0!	0.00	0.00%	0.00	0.00	0.00%	
	Agricultural	0	0	0	#DIV/0!	0	0	0	#DIV/0!		0.000	0.000	0.000	#DIV/0!			0.00	0.00	0.00%	
	Commercial/Industrial-LT	0	0	0	#DIV/0!	0	0	0	#DIV/0!		0.000	0.000	0.000	#DIV/0!			0.00	0.00	0.00%	
	Commercial/Industrial-HT	0	0	0	#DIV/0!	0	0	0	#DIV/0!		0.000	0.000	0.000	#DIV/0!			0.00	0.00	0.00%	
	Others	0	0	0	#DIV/0!	0	0	0	#DIV/0!		0.000	0.000	0.000	#DIV/0!			0.00	0.00	0.00%	
Sub-total		0	0	0	100%	0	0	0	100%	0.00	0.000	0.000	0.000	100%	0.00	0.00%	0.00	0.00	0.00%	100%
109	Residential	0	0	0	#DIV/0!	0	0	0	#DIV/0!	0.00	0.000	0.000	0.000	#DIV/0!	0.00	0.00%	0.00	0.00	0.00%	
	Agricultural	0	0	0	#DIV/0!	0	0	0	#DIV/0!		0.000	0.000	0.000	#DIV/0!			0.00	0.00	0.00%	
	Commercial/Industrial-LT	0	0	0	#DIV/0!	0	0	0	#DIV/0!		0.000	0.000	0.000	#DIV/0!			0.00	0.00	0.00%	
	Commercial/Industrial-HT	0	0	0	#DIV/0!	0	0	0	#DIV/0!		0.000	0.000	0.000	#DIV/0!			0.00	0.00	0.00%	
	Others	0	0	0	#DIV/0!	0	0	0	#DIV/0!		0.000	0.000	0.000	#DIV/0!			0.00	0.00	0.00%	
Sub-total		0	0	0	100%	0	0	0	100%	0.00	0.000	0.000	0.000	100%	0.00	0.00%	0.00	0.00	0.00%	100%
110	Residential	0	0	0	#DIV/0!	0	0	0	#DIV/0!	0.00	0.000	0.000	0.000	#DIV/0!	0.00	0.00%	0.00	0.00	0.00%	
	Agricultural	0	0	0	#DIV/0!	0	0	0	#DIV/0!		0.000	0.000	0.000	#DIV/0!			0.00	0.00	0.00%	
	Commercial/Industrial-LT	0	0	0	#DIV/0!	0	0	0	#DIV/0!		0.000	0.000	0.000	#DIV/0!			0.00	0.00	0.00%	
	Commercial/Industrial-HT	0	0	0	#DIV/0!	0	0	0	#DIV/0!		0.000	0.000	0.000	#DIV/0!			0.00	0.00	0.00%	
	Others	0	0	0	#DIV/0!	0	0	0	#DIV/0!		0.000	0.000	0.000	#DIV/0!			0.00	0.00	0.00%	
Sub-total		0	0	0	100%	0	0	0	100%	0.00	0.000	0.000	0.000	100%	0.00	0.00%	0.00	0.00	0.00%	100%
76	Total	7738346	0	7738346	74%	15110.24665	0	15110.24665	35%	66160.34	17493.719	0.000	17493.719	30%	7451.75	11.26%	0.00	0.00	0.00%	
	Agricultural	8510	1382434	1390944	13%	47.86527	11135.54634	11183.41161	26%		164.549	13598.017	13762.566	23%			0.00	0.00	0.00%	
	Commercial/Industrial-LT	1367936	0	1367936	13%	8244.255339	0	8244.255339	19%		8070.323	211.830	8282.153	14%			0.00	0.00	0.00%	
	Commercial/Industrial-HT	10275	0	10275	0%	7854.894421	0	7854.894421	18%		17359.147	112.490	17471.637	30%			0.00	0.00	0.00%	
	Others	6249	0	6249	0%	449.98986	0	449.98986	1%		1859.754	-161.230	1698.524	3%			37019.66	41743.16	100.00%	
At company level		9131316	1382434	10513750	100%	31707.25154	11135.54634	42842.798	100%	66160.34	44947.491	13761.107	58708.60	100%	7451.75	11.26%	37019.66	41743.16	100.00%	11.26%

** Note - It shall be mandatory to record the energy supplied separately for each category of consumers which is being provided a separate rate of subsidy in the tariff, by the state government, so that the subsidy due for the electricity distribution company is quarterly calculated by multiplying the energy supplied to each of such category of consumers by the applicable

Color	Parameter
	Please enter name of circle
	Please enter circle code
0	Please enter numeric value or 0
	Formula protected

I/We undertake that the information supplied in this Document and Pro-forma is accurate to the best of my knowledge and if any of the information supplied is found to be incorrect and such information result into loss to the Central Government or State Government or any of the authority under them or any other person affected, I/we undertake to indemnify such loss.

Authorised Signatory and Seal

Name of Authorised Signatory:

(Er. Hira Lal Goyal)
SE/EA & Enforcement

Name of the DISCOM:

Full Address:-

Seal

S.E./DSM,
P.S.P.C.L., Patiala

Signature:
Er. Ravi Verma
Name of Energy Manager:
EA-796,
Register No. Number:
Energy Auditor
PSPCL, Patiala

Form-input energy (Details of Input energy & Infrastructure)

A. Summary of energy input & Infrastructure

S.No	Parameters	Period from 01.04.2022 To 31.03.2023	Remarks (Source of data)
A.1	Input Energy purchased (MU)	70329	Historical Data
A.2	Transmission loss (%)	5.93%	
A.3	Transmission loss (MU)	4168.35	1440.37+2728.69 (Inter State-Intra state)
A.4	Energy sold outside the periphery (MU)	693.47	380.24(Historical data sheet)+303.23 B8MB Common pool Share
A.5	Open access sale (MU)	0.2	(0.18+0.02)Historical data
A.6	EHT sale		
A.7	Net input energy (received at DISCOM periphery or at distribution point)-(MU)	66160	
A.8	Is 100% metering available at 66/33 kV (Select yes or no from list)	Yes	
A.9	Is 100% metering available at 11 kV (Select yes or no from list)	Yes	
A.10	% of metering available at DT		Completion of the HVDS/Pillar Box installation in the AP/DS consumers may obviate the need for "Separate" DT meter installation due to virtually LT-less LD system
A.11	% of metering available at consumer end	86.85%	
A.12	No of feeders at 66kV and above voltage level	168	Director/D
A.13	No of feeders at 33kV voltage level	5	Director/D
A.14	No of feeders at 11kV voltage level	12975	Director/D
A.15	No of LT feeders level		
A.16	Line length (ckt. km) at 66kV voltage level	14289	Planning
A.17	Line length (ckt. km) at 33kV voltage level	71	Planning
A.18	Line length (ckt. km) at 11kV voltage level	252006	Planning
A.19	Line length (km) at LT level	159732	Planning
A.20	Length of Aerial Bunched Cables	NA	
A.21	Length of Underground Cables	NA	
A.22	HT/LT ratio	1.64	

B. Meter reading of input energy at injection points

S.No	Zone	Circle	Voltage level (kVA)	Division (kVA)	Sub-Division (kVA)	Feeder ID	Feeder Name	Feeder Metering Status (Metered/unmetered/AMB/AMR)	Status of Meter (Functional/Non-functional)	Metering Date (Date of last actual meter reading/communication)	Feeder Type (Agri/Industrial/Other)	Status of Communication			Period from 01.04.2022 to 31.03.2023			Rate	Remarks (Source of data)
												% data received through automatically if feeder AMR/AMB	Number of hours when meter was unable to communicate in serial	Total Number of hours in the month	Meter S.No	CT/PT ratio	Input (MU)		
B.1	Border	CITY AMRITSAR	11KV	DS CITY CENTER DIVN.	DS S/D GHEE MANDI TECH. ASR	C751FL09	11KV NEW GOLDEN AVENUE	AMR	OK	31.03.2023	Category 1				7042899	900-450/ 577/1-1-1	5.220	NA	Director/D
B.2	Border	CITY AMRITSAR	11KV	DS CITY CENTER DIVN.	DS S/D GHEE MANDI TECH. ASR	C754FL01	HUSSAINPURA	AMR	OK	31.03.2023	Category 1				6489702	900-450/ 577/1-1-1	7.634	NA	Director/D
B.3	Border	CITY AMRITSAR	11KV	DS CITY CENTER DIVN.	DS S/D GHEE MANDI TECH. ASR	C751FL02	Head Water Works Road	AMR	OK	31.03.2023	Category 1				6675550	900-450/ 577/1-1-1	8.306	NA	Director/D
B.4	Border	CITY AMRITSAR	11KV	DS CITY CENTER DIVN.	DS S/D GHEE MANDI TECH. ASR	C751FL08	11KV New Ravi Dass Road	AMR	OK	31.03.2023	Category 1				2046495	1200/ 577/1-1-1	10.577	NA	Director/D
B.5	Border	CITY AMRITSAR	11KV	DS CITY CENTER DIVN.	DS S/D GHEE MANDI TECH. ASR	C754FL13	11KV NEW KESRI BAGH	AMR	OK	31.03.2023	Category 1				198076	1200/ 577/1-1-1	2.649	NA	Director/D
B.6	Border	CITY AMRITSAR	11KV	DS CITY CENTER DIVN.	DS S/D GHEE MANDI TECH. ASR	D754FL02	11KV Ghee Mandi 2	AMR	OK	31.03.2023	Category 1				4180050	1200/ 577/1-1-1	5.263	NA	Director/D
B.7	Border	CITY AMRITSAR	11KV	DS CITY CENTER DIVN.	DS S/D GHEE MANDI TECH. ASR	D754FL01	11KV Kesri Bagh	AMR	OK	31.03.2023	Category 1				6740734	1200/ 577/1-1-1	5.889	NA	Director/D
B.8	Border	CITY AMRITSAR	11KV	DS CITY CENTER DIVN.	DS S/D GHEE MANDI TECH. ASR	D754FL09	11 KV MOTI BAZAR	AMR	OK	31.03.2023	Category 1				33685	1200/ 577/1-1-1	6.132	NA	Director/D
B.9	Border	CITY AMRITSAR	11KV	DS CITY CENTER DIVN.	DS S/D GHEE MANDI TECH. ASR	D754FL04	11KV Chattiwind	AMR	OK	31.03.2023	Category 1				2993713	1200/ 577/1-1-1	6.518	NA	Director/D
B.10	Border	CITY AMRITSAR	11KV	DS CITY CENTER DIVN.	DS S/D GHEE MANDI TECH. ASR	D754FL03	11KV Navdeep Theatre	AMR	OK	31.03.2023	Category 1				4221178	1200/ 577/1-1-1	6.538	NA	Director/D
B.11	Border	CITY AMRITSAR	11KV	DS CITY CENTER DIVN.	DS S/D GHEE MANDI TECH. ASR	D751FL19	11 KESRI BAGH HG	AMR	OK	31.03.2023	Category 1				198080	1200/ 577/1-1-1	0.000	NA	Director/D
B.12	Border	CITY AMRITSAR	11KV	DS CITY CENTER DIVN.	DS S/D GHEE MANDI TECH. ASR	D751FL20	DHARAM SINGH MKRT INTERLINK	AMR	OK	31.03.2023	Category 1				197831	1200/ 577/1-1-1	0.000	NA	Director/D
B.13	Border	CITY AMRITSAR	11KV	DS CITY CENTER DIVN.	DS S/D HUSSAINPURA TECH. ASR	D754FL12	BHARAWA DA DHABHA	AMR	OK	31.03.2023	Category 1				36961	1200/ 577/1-1-1	0.000	NA	Director/D
B.14	Border	CITY AMRITSAR	11KV	DS CITY CENTER DIVN.	DS S/D HUSSAINPURA TECH. ASR	D754FL14	11 KV SUBASH PARK	AMR	OK	31.03.2023	Category 1				197948	1200/ 577/1-1-1	0.000	NA	Director/D
B.15	Border	CITY AMRITSAR	11KV	DS CITY CENTER DIVN.	DS S/D HUSSAINPURA TECH. ASR	D754FL15	11 KV MASHI MANDI	NON AMR	OK	31.03.2023	Category 1				34057	1200/ 577/1-1-1	0.000	NA	Director/D
B.16	Border	CITY AMRITSAR	11KV	DS CITY CENTER DIVN.	DS S/D HUSSAINPURA TECH. ASR	D754FL26	Kairon Market	AMR	OK	31.03.2023	Category 1				197839	1200/ 577/1-1-1	0.000	NA	Director/D
B.17	Border	CITY AMRITSAR	11KV	DS CITY CENTER DIVN.	DS S/D HUSSAINPURA TECH. ASR	D754FL13	11 KV TOWN HALL	AMR	OK	31.03.2023	Category 1				33683	1200/ 577/1-1-1	1.627	NA	Director/D
B.18	Border	CITY AMRITSAR	11KV	DS CITY CENTER DIVN.	DS S/D HUSSAINPURA TECH. ASR	D754FL05	Cheel Mandi	AMR	OK	31.03.2023	Category 1				33714	1200/ 577/1-1-1	9.391	NA	Director/D
B.19	Border	CITY AMRITSAR	11KV	DS CITY CENTER DIVN.	DS S/D HUSSAINPURA TECH. ASR	D752FL10	11KV HussainPura	AMR	OK	31.03.2023	Category 1				7042893	1200/ 577/1-1-1	10.334	NA	Director/D
B.20	Border	CITY AMRITSAR	11KV	DS CITY CENTER DIVN.	DS S/D HUSSAINPURA TECH. ASR	D751FL04	11KV Hall Bazar	AMR	OK	31.03.2023	Category 1				3065894	1200/ 577/1-1-1	0.000	NA	Director/D
B.21	Border	CITY AMRITSAR	11KV	DS CITY CENTER DIVN.	DS S/D HUSSAINPURA TECH. ASR	D751FL10	11 KV Katra Baghian	AMR	OK	31.03.2023	Category 1				6761900	1200/ 577/1-1-1	0.000	NA	Director/D
B.22	Border	CITY AMRITSAR	11KV	DS CITY CENTER DIVN.	DS S/D HUSSAINPURA TECH. ASR	D751FL14	11KV Civil Hospital Independent	AMR	OK	31.03.2023	Category 2				9154108	1200/ 577/1-1-1	1.213	NA	Director/D
B.23	Border	CITY AMRITSAR	11KV	DS CITY CENTER DIVN.	DS S/D HUSSAINPURA TECH. ASR	D751FL23	MASHI MANDI	AMR	OK	31.03.2023	Category 1				197891	1200/ 577/1-1-1	1.692	NA	Director/D
B.24	Border	CITY AMRITSAR	11KV	DS CITY CENTER DIVN.	DS S/D HUSSAINPURA TECH. ASR	D751FL22	BHARAWA DA DHABHA	AMR	OK	31.03.2023	Category 1				73164577	1200/ 577/1-1-1	1.885	NA	Director/D
B.25	Border	CITY AMRITSAR	11KV	DS CITY CENTER DIVN.	DS S/D HUSSAINPURA TECH. ASR	D751FL25	SUBASH PARK	NON AMR	OK	31.03.2023	Category 1				73161875	1200/ 577/1-1-1	2.496	NA	Director/D
B.26	Border	CITY AMRITSAR	11KV	DS CITY CENTER DIVN.	DS S/D HUSSAINPURA TECH. ASR	D751FL24	KARION MARKET	AMR	OK	31.03.2023	Category 1				197938	1200/ 577/1-1-1	3.567	NA	Director/D
B.27	Border	CITY AMRITSAR	11KV	DS CITY CENTER DIVN.	DS S/D HUSSAINPURA TECH. ASR	D751FL21	TOWN HALL	AMR	OK	31.03.2023	Category 1				197886	1200/ 577/1-1-1	4.111	NA	Director/D
B.28	Border	CITY AMRITSAR	11KV	DS CITY CENTER DIVN.	DS S/D HUSSAINPURA TECH. ASR	D751FL07	11KV saraswati	AMR	OK	31.03.2023	Category 1				3067573	1200/ 577/1-1-1	4.632	NA	Director/D
B.29	Border	CITY AMRITSAR	11KV	DS CITY CENTER DIVN.	DS S/D HUSSAINPURA TECH. ASR	D751FL02	11KV Ram Bagh	NON AMR	OK	31.03.2023	Category 1				3067982	1200/ 577/1-1-1	6.936	NA	Director/D
B.30	Border	CITY AMRITSAR	11KV	DS CITY CENTER DIVN.	DS S/D MALL MANDI TECH. ASR	C751DL11	11 KV Bhai Gurdas Ji Nagar	AMR	OK	31.03.2023	Category 1				5475	1200/ 577/1-1-1	4.101	NA	Director/D
B.31	Border	CITY AMRITSAR	11KV	DS CITY CENTER DIVN.	DS S/D MALL MANDI TECH. ASR	C751FL14	Kapoor Nagar	AMR	OK	31.03.2023	Category 1				9154236	1200/ 577/1-1-1	7.299	NA	Director/D
B.32	Border	CITY AMRITSAR	11KV	DS CITY CENTER DIVN.	DS S/D MALL MANDI TECH. ASR	C751FL13	Gobind Nagar	AMR	OK	31.03.2023	Category 1				5343286	900-450/ 577/1-1-1	13.171	NA	Director/D
B.33	Border	CITY AMRITSAR	11KV	DS CITY CENTER DIVN.	DS S/D MALL MANDI TECH. ASR	C801FL03	J C MOTOR	AMR	OK	31.03.2023	Category 2				2046990	1200/ 577/1-1-1	0.000	NA	Director/D
B.34	Border	CITY AMRITSAR	11KV	DS CITY CENTER DIVN.	DS S/D MALL MANDI TECH. ASR	C801FL2	KHANIKOT	AMR	OK	31.03.2023	Category 1				2068199	1200/ 577/1-1-1	1.631	NA	Director/D
B.35	Border	CITY AMRITSAR	11KV	DS CITY CENTER DIVN.	DS S/D MALL MANDI TECH. ASR	C801FL08	Bypass	AMR	OK	31.03.2023	Category 1				10288933	1200/ 577/1-1-1	5.553	NA	Director/D
B.36	Border	CITY AMRITSAR	11KV	DS CITY CENTER DIVN.	DS S/D MALL MANDI TECH. ASR	C801FL06	GT road	AMR	OK	31.03.2023	Category 1				11052041	1200/ 577/1-1-1	11.540	NA	Director/D
B.37	Border	CITY AMRITSAR	11KV	DS CITY CENTER DIVN.	DS S/D MALL MANDI TECH. ASR	C801FL04	Bhai Lalaji Nagar	AMR	OK	31.03.2023	Category 1				11052009	1200/ 577/1-1-1	13.391	NA	Director/D
B.38	Border	CITY AMRITSAR	11KV	DS CITY CENTER DIVN.	DS S/D MALL MANDI TECH. ASR	C801FL13	GTB FOCAL POINT	AMR	OK	31.03.2023	Category 2				10282977	1200/ 577/1-1-1	13.879	NA	Director/D
B.39	Border	CITY AMRITSAR	11KV	DS CITY CENTER DIVN.	DS S/D MALL MANDI TECH. ASR	C801FL10	New Focal point	AMR	OK	31.03.2023	Category 2				11081370	1200/ 577/1-1-1	14.696	NA	Director/D
B.40	Border	CITY AMRITSAR	11KV	DS CITY CENTER DIVN.	DS S/D MALL MANDI TECH. ASR	C801FL11	New Amritsar	AMR	OK	31.03.2023	Category 1				11057979	1200/ 577/1-1-1	15.829	NA	Director/D
B.41	Border	CITY AMRITSAR	11KV	DS CITY CENTER DIVN.	DS S/D MALL MANDI TECH. ASR	C801FL02	Foclpoint old	AMR	OK	31.03.2023	Category 2				10282977	1200/ 577/1-1-1	23.059	NA	Director/D
B.42	Border	CITY AMRITSAR	11KV	DS CITY CENTER DIVN.	DS S/D MALL MANDI TECH. ASR	D945FL04	Bhai Shanyis Ji	AMR	OK	31.03.2023	Category 1				73142114	1200/ 577/1-1-1	2.380	NA	Director/D
B.43	Border	CITY AMRITSAR	11KV	DS CITY CENTER DIVN.	DS S/D MALL MANDI TECH. ASR	D945FL01	BABA DEEP SINGH	NON AMR	OK	31.03.2023	Category 1				33849	1200/ 577/1-1-1	7.940	NA	Director/D
B.44	Border	CITY AMRITSAR	11KV	DS CITY CENTER DIVN.	DS S/D MALL MANDI TECH. ASR	945FL08	11 KV SULTANWIND-1	AMR	OK	31.03.2023	Category 1				33833	1200/ 577/1-1-1	11.035	NA	Director/D

**B.E./DSM,
P.S.P.C.L., Patiala**

Dr. Rawal Bermania
EA-795-9
Energy Auditor
PSP, Patiala.

S.No	Zone	Circle	Voltage Level (KV)	Division (DIV)	Sub-Division (SDV)	Feeder ID	Feeder Name	Feeder Metering Status (Meters/ un-metered: AMR/AMR)	Status of Meter (Functional/Non-functional)	Metering Date (Date of last actual meter reading/ communication)	Feeder Type (Agri/ Industrial/ Mixed)	Status of Communication			Period from 01.04.2023 to 31.03.2023		Neto	Remarks (Source of data)			
												% data received through automatically if Feeder AMR/AMI	Number of hours when meter was unable to communicate in period	Total Number of hours in the period	Meter S.No	CT/PT ratio			Import (MU)	Export (MU)	
B.13142	West	MUKATSAR	11KV	DS DIVN. MUKTSAR	Sub Office Lakhewali	D528FL04	RORANWALI (UPS)	AMR	OK	31.03.2023	Category 5-UPS				2068216	1200-600/5	8.575	NA	Director/D		
B.13143	West	MUKATSAR	11KV	DS DIVN. MUKTSAR	Sub Office Lakhewali	D527FL06	Samewali	AMR	OK	31.03.2023	AP 3Phase 3Wire				4814	1200-600/5	0.560	NA	Director/D		
B.13144	West	MUKATSAR	11KV	DS DIVN. MUKTSAR	Sub Office Lakhewali	D527FL05	NANDGARH AP	AMR	OK	31.03.2023	AP 3Phase 3Wire				33977	1200-600/5	1.256	NA	Director/D		
B.13145	West	MUKATSAR	11KV	DS DIVN. MUKTSAR	Sub Office Lakhewali	D527FL02	Madressa Lkw(AP)	AMR	OK	31.03.2023	AP 3Phase 3Wire				2047143	1200-600/5	1.675	NA	Director/D		
B.13146	West	MUKATSAR	11KV	DS DIVN. MUKTSAR	Sub Office Lakhewali	E503FL03	Roranwali(AP)	AMR	OK	31.03.2023	AP 3Phase 3Wire				2066564	1200-600/5	1.871	NA	Director/D		
B.13147	West	MUKATSAR	11KV	DS DIVN. MUKTSAR	Sub Office Lakhewali	D527FL04	Nand Garh	AMR	OK	31.03.2023	Category 5-UPS				2995270	1200-600/5	5.003	NA	Director/D		
B.13148	West	MUKATSAR	11KV	DS DIVN. MUKTSAR	Sub Office Lakhewali	D527FL01	Lakhewali(Urban)			31.03.2023	Category 1 Roof Top Solar				2066948	1200-600/5	5.569	NA	Director/D		
B.13149																101.911					
B.13150	Total (MU)															66160.32					
B.13151	Net Input energy at DISCOM periphery (MU)																			66160.32	

Color code	Parameter
	Please enter voltage level or leave blank
	Please enter feeder id and name or leave blank
	Enter meter no or leave blank
	Enter CT/PT ratio or leave blank
0	Please enter numeric value or 0
	Please select yes or no from list
	Formula protected

I/We undertake that the information supplied in this Document and Pro-forma is accurate to the best of my knowledge and if any of the information supplied is found to be incorrect and such information result into loss to the Central Government or State Government or any of the authority under them or any other person affected, I/we undertake to indemnify such loss.

Authorized Signatory and Seal

Name of Authorized Signatory
Name of the DISCOM
Full Address--

Seal

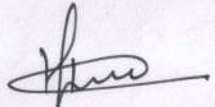
(Er. Hira Lal Goyal)
SE/EA & Enforcement

S.E./DSM,
P.S.P.C.L., Patiala

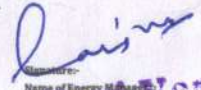
Er. Ravi Verma
EA- 796 9
Energy Auditor
PSPCL, Patiala.

Details of Input Energy Sources								
Period From 01.04.2022 To 31.03.2023								
A. Generation at Transmission Periphery (Details)								
S.No.	Name of Generation Station	Generation Capacity (in MW)	Type of Station Generation (Based - Solid (Coal, Lignite)/Liquid/Gas/Renewable)	Type of Contract (in years/months/days)	Type of Grid (Intra-state/Inter-)	Point of Connection (POC) Loss	Voltage Level (At input)	Remarks (Source of data)
A	i) Solar (Intrastate)					Net Energy		
1	Abundant Energy Pvt. Ltd, Plant-I	2	Solar (Intrastate)	Long Term	66 KV	2.794	11	ISB
2	Abundant Energy Pvt. Ltd, Plant-II	1	Solar (Intrastate)	Long Term	66 KV	1.352	11	ISB
3	Acme Solar Rooftop system pvt. Ltd. Jhunir	15	Solar (Intrastate)	Long Term	66KV S/Stn.	21.375	66	ISB
4	Acme Solar Rooftop system pvt. Ltd. Nangla, Tahwandi Sahib	15	Solar (Intrastate)	Long Term	66 KV	21.695	66	ISB
5	Aditya Medisales Ltd., Lalpur, Hoshierpur	4	Solar (Intrastate)	Long Term	66 KV	5.420	66	ISB
6	Allianz Ecopower Pvt. Ltd., Boparai Kalan, Ludhiana	2	Solar (Intrastate)	Long Term	66 KV	2.669	11	ISB
7	Aster Solar Power Pvt. Ltd., Jhunir, Mansa	1	Solar (Intrastate)	Long Term	220 KV	1.473	11	ISB
8	Atma Powers Pvt. Ltd., Lakhewali, Mukatsar	2	Solar (Intrastate)	Long Term	66 KV S/s	2.790	11	ISB
9	Azure Power Makemake Pvt. Ltd., Bhittiwala	4	Solar (Intrastate)	Long Term	66 KV	5.824	66	ISB
10	Azure Power Makemake Pvt. Ltd., Killianwali	24	Solar (Intrastate)	Long Term	66 KV	37.088	66	ISB
11	Azure Power Pluto Pvt. Ltd., Bahadurgarh Jandia-1	25	Solar (Intrastate)	Long Term	66 KV Peori	37.719	66	ISB
12	Azure Power Pluto Pvt. Ltd., Bahadurgarh Jandia-2	25	Solar (Intrastate)	Long Term	66 KV	38.011	66	ISB
13	Azure Power Pluto Pvt. Ltd., Korianwali	25	Solar (Intrastate)	Long Term	66 KV	37.068	66	ISB
14	Azure Power Pluto Pvt. Ltd., Badai	15	Solar (Intrastate)	Long Term	132 KV	23.351	66	ISB
15	Azure Power Pluto Pvt. Ltd., Bahadurkhara	25	Solar (Intrastate)	Long Term	66 KV	38.339	66	ISB
16	Azure Power Pluto Pvt. Ltd., Bhittiwala	10	Solar (Intrastate)	Long Term	66 KV	15.523	66	ISB
17	Azure Power Pluto Pvt. Ltd., Varwala	25	Solar (Intrastate)	Long Term	66 KV	37.653	66	ISB
18	Azure Renewable Energy Pvt. Ltd., PSAMB, Mansa	0.83	Solar (Intrastate)	Long Term	66 KV Anaj	0.558	11	ISB
19	Azure Renewable Energy Pvt. Ltd., Bhagwant singh & Kulwinder kaur,	0.95	Solar (Intrastate)	Long Term	66 KV	0.000	11	ISB
20	Azure Renewable Energy Pvt. Ltd., Anil Singla Warehouse, Mukatsar	0.801	Solar (Intrastate)	Long Term	66 KV	0.000	11	ISB
21	Azure Renewable Energy Pvt. Ltd., Vikas Singla Warehouse, Jodhpur	0.503	Solar (Intrastate)	Long Term	66 KV	0.000	11	ISB
22	Azure Renewable Energy Pvt. Ltd., Boss Computers Ltd. Zirakpur	1.25	Solar (Intrastate)	Long Term	66 KV	0.000	11	ISB
23	Azure Renewable Energy Pvt. Ltd., CA Veg Fruits, Kharar	0.599	Solar (Intrastate)	Long Term	66 KV	0.591	11	ISB
24	Azure Renewable Energy Pvt. Ltd., Canam Cons. Morinda	1.80	Solar (Intrastate)	Long Term	66 KV	1.144	11	ISB
25	Azure Renewable Energy Pvt. Ltd., PSAMB, Ludhiana	0.76	Solar (Intrastate)	Long Term	66 KV	0.472	11	ISB
26	Azure Renewable Energy Pvt. Ltd.s, PSAMB, Mohali	2.05	Solar (Intrastate)	Long Term	66 KV. Ph.	1.311	11	ISB
27	Azure Renewable Energy Pvt. Ltd., Skyross, sangrur	1.26	Solar (Intrastate)	Long Term	66 KV	1.199	11	ISB
28	Azure Urja Pvt. Ltd., 15 MW (Tahilwal jattan), Project-I	15	Solar (Intrastate)	Long Term	66 KV	19.564	66	ISB
29	Azure Urja Pvt. Ltd., 15 MW (Sikhwala / Punjwa), Project-II	15	Solar (Intrastate)	Long Term	66 KV	20.413	66	ISB
30	Azure Urja Pvt. Ltd., 4 MW (Sikhwala / Punjwa), Project-III	4	Solar (Intrastate)	Long Term	66 KV	5.542	66	ISB
31	Bhanuenergy Industrial Development Ltd. (BIOL)	15	Solar (Intrastate)	Long Term	66 KV Alike	21.996	66	ISB
32	Bhanuenergy Infrastructure Pvt. Ltd. (BIPL)	15	Solar (Intrastate)	Long Term	66 KV Alike	22.095	66	ISB
33	Canal Solar Energy Pvt. Ltd.	7.5	Solar (Intrastate)	Long Term	66KV	7.695	66	ISB
34	Carilli Energy Pvt. Ltd., Bhagsar, Mukatsar	1.5	Solar (Intrastate)	Long Term	66 KV S/s	1.857	11	ISB
35	Continental Engineering & Power Pvt. Ltd.	1	Solar (Intrastate)	Long Term	66 KV Kot	1.417	11	ISB
36	Earth Solar Pvt. Ltd., Behbalpur, Nabha	4	Solar (Intrastate)	Long Term	66 KV	4.755	66	ISB
37	Enterprise Business Solutions Pvt. Ltd., Sahiba -Shadhra, SBS Nagar	1.5	Solar (Intrastate)	Long Term	66KV S/Stn.	1.093	11	ISB
38	Ecoenergy inc., Boparai kalen, Ludhiana	1	Solar (Intrastate)	Long Term	66KV S/Stn.	0.960	11	ISB
39	Focal Energy Solar India Pvt. Ltd., Nangla, Bathinda	4	Solar (Intrastate)	Long Term	66 KV	6.073	66	ISB
40	G.S. Atwal & Co (Engineers) Pvt. Ltd., Bhuttival Mukatsar	1.5	Solar (Intrastate)	Long Term	66KV S/Stn.	1.570	11	ISB

S.E./DSM,
P.S.P.C.L., Patiala

Er. Ravi Verma
EA- 796g
Energy Auditor
PSPCL, Patiala.

41	IK Energy Pvt. Ltd.,Lallian Kalan, Jalandhar	1	Solar (Intrastate)	Long Term	66 KV Chitti	1.094	11	ISB
42	International Switchgears Pvt. Ltd.,Ph-I, Ramdas, Amritsar	1	Solar (Intrastate)	Long Term	66 KV	0.917	11	ISB
43	International Switchgears Pvt. Ltd.,Ph-II, Ramdas, Amritsar	1	Solar (Intrastate)	Long Term	66 KV	1.074	11	ISB
44	JSSK Energy Pvt. Ltd.	1	Solar (Intrastate)	Long Term	66 KV	1.402	11	ISB
45	Madhav Solar Pvt. Ltd-I, Boha, Mansa	2	Solar (Intrastate)	Long Term	66 KV	2.620	11	ISB
46	Madhav Solar Pvt. Ltd-II, Boha, mansa	2	Solar (Intrastate)	Long Term	66 KV	3.026	11	ISB
47	Magnet Buildtech Pvt. Ltd -I,Sherkawala	25	Solar (Intrastate)	Long Term	66 KV Boha	36.056	66	ISB
48	Magnet Buildtech Pvt. Ltd-II, Toderpur	25	Solar (Intrastate)	Long Term	66 KV Boha	36.904	66	ISB
49	Magnificent Power Pvt. Ltd.	1	Solar (Intrastate)	Long Term	220 KV S/S	1.380	11	ISB
50	Mihit Solar Power Pvt. Ltd., Jhandakalan	24	Solar (Intrastate)	Long Term	66 KV	35.920	66	ISB
51	Mihit Solar Power Pvt. Ltd., Khera khurad	25	Solar (Intrastate)	Long Term	66 KV	38.004	66	ISB
52	Mihit Solar Power Pvt. Ltd., Mankhera	25	Solar (Intrastate)	Long Term	66 KV	38.815	66	ISB
53	Mokia Green Energy Pvt.Ltd., Boparai Kalan, Ludhiana	4	Solar (Intrastate)	Long Term	66 KV	5.634	66	ISB
54	Mytrah Aadhya Power Pvt. Ltd.-Balran	25	Solar (Intrastate)	Long Term	66 KV	40.044	66	ISB
55	Mytrah Aadhya Power Pvt. Ltd.-Bareta	25	Solar (Intrastate)	Long Term	66 KV	38.430	66	ISB
56	Nextgen Solux Power Pvt. Ltd. , Mirpurkalan, Mansa-I	1	Solar (Intrastate)	Long Term	66KV Alike	1.477	11	ISB
57	Nextgen Solux Power Pvt. Ltd. , Jhunir, Mansa-II	1	Solar (Intrastate)	Long Term	220 KV	1.468	11	ISB
58	Northstar Solar Power Pvt. Ltd. , Pathraia, Bathinda	4	Solar (Intrastate)	Long Term	66KV	6.037	66	ISB
59	Oasis Green Pvt. Ltd.	3	Solar (Intrastate)	Long Term	66 KV	4.257	66	ISB
60	Omega infraengineers Pvt. Ltd.	1	Solar (Intrastate)	Long Term	66 KV	1.232	11	ISB
61	Omega Solar Projects Pvt. Ltd., Sangatpur, Lehragara	10	Solar (Intrastate)	Long Term	66KV	14.088	66	ISB
62	Phulokheri PEDA SPV	1	Solar (Intrastate)	Long Term	66KV Rama	1.073	11	ISB
63	Photon Sunbeam Pvt. Ltd.-I	15	Solar (Intrastate)	Long Term	66 KV	20.851	66	ISB
64	Photon Sunbeam Pvt. Ltd.-II	25	Solar (Intrastate)	Long Term	220 KV	32.342	66	ISB
65	PN Clean Energy Ltd., Lakhmirwala, Mansa	20	Solar (Intrastate)	Long Term	66 KV	29.436	66	ISB
66	PN Renewable Energy Ltd.,Barra, Mansa	10	Solar (Intrastate)	Long Term	66 KV	14.544	66	ISB
67	Prayatna Developers Pvt. Ltd.-I, Sardargarh	50	Solar (Intrastate)	Long Term	132 KV	82.439	132	ISB
68	Prayatna Developers Pvt. Ltd.-II Chughekalan	50	Solar (Intrastate)	Long Term	132 KV	82.708	132	ISB
69	Purshotam Industries Ltd.,VIII, Bajak, Bathinda	3	Solar (Intrastate)	Long Term	66 KV	4.321	66	ISB
70	Radient Solar Energies Pvt. Ltd.	3	Solar (Intrastate)	Long Term	66 KV	4.504	66	ISB
71	RSSB Educational & Environmental Society, Beas (New)	12	Solar (Intrastate)	Long Term	132KV	15.275	132	ISB
72	RSSB Educational & Environmental Society , Beas (Old)	7.52	Solar (Intrastate)	Long Term	132KV Beas	8.629	132	ISB
73	SAM SOLAR Pvt. Ltd. Doraha, Canal top	2.5	Solar (Intrastate)	Long Term	66 KV	3.014	11	ISB
74	SAM SOLAR Pvt. Ltd.Nidampur, Sangrur	2.5	Solar (Intrastate)	Long Term	66 KV	2.230	11	ISB
75	Solairdirect Projects India Pvt. Ltd., Dharangwala, Fazilka	20	Solar (Intrastate)	Long Term	66 KV	30.334	66	ISB
76	Solair Power Pvt. Ltd. Usmanikhera	24	Solar (Intrastate)	Long Term	66 KV	37.479	66	ISB
77	Solair Urja Pvt Ltd.	25	Solar (Intrastate)	Long Term	66 KV	34.506	66	ISB
78	Soma Enterprises Ltd. , Khera Kaimout	1	Solar (Intrastate)	Long Term	66KV	0.875	11	ISB
79	Sovox Renewables Pvt. Ltd., Mehandipur	1	Solar (Intrastate)	Long Term	66KV S/Strn.	0.672	11	ISB
80	T R Energy & Agro Pvt. Ltd., Jandwala Mirangla, Fazilka	2	Solar (Intrastate)	Long Term	66 KV	2.893	11	ISB
81	T R Energy & Agro Pvt. Ltd., Vill. Pathraia, Fazilka II	1	Solar (Intrastate)	Long Term	66 KV	1.626	11	ISB
82	Vector Green Sunshine Pvt. Ltd., Gamiwala Boha	20	Solar (Intrastate)	Long Term	66 KV	29.568	66	ISB
83	Vector Green Surya Urja Pvt. Ltd., Gamiwala, Boha, Mansa	20	Solar (Intrastate)	Long Term	66 KV	30.804	66	ISB
84	Vijay Printing Press Pvt. Ltd.,Ghagar branch canal (Rooftop)	7.5	Solar (Intrastate)	Long Term	66KV	9.316	66	ISB
85	Vivean Solar Pvt. Ltd., Bajak Bathinda	2	Solar (Intrastate)	Long Term	66 KV	2.923	11	ISB
86	Walwhan Solar Punjab Ltd.-I, Tiona pujaran,	20	Solar (Intrastate)	Long Term	66 KV	27.514	66	ISB
87	Walwhan Solar Punjab Ltd.-II, Jagaram tirath,	10	Solar (Intrastate)	Long Term	66 KV	13.766	66	ISB
88	Walwhan Solar Punjab Ltd.-III, Jagaram Tirath	2	Solar (Intrastate)	Long Term	66 KV	2.701	11	ISB
89	Walwhan Solar Punjab Ltd.- IV, Tiona pujaran,	4	Solar (Intrastate)	Long Term	66 KV	5.359	66	ISB
	i) Total Solar (Intrastate)	884.02				1292.026		ISB

S.E.DSM,
P.B.P.C.L., Patiala

Er. Ravi Verma
EA- 7969
Energy Auditor
PSPCL, Patiala.

	ii) Solar (Interstate)							
1	Bundled NVVNL (solar only)	37	Solar (Interstate)	Long Term	Outside	52.482		
2	SECI Solar	30	Solar (Interstate)	Long Term	Outside	55.819		
	Total ii)	67.00				108.302		
	Total Solar (+ ii)	951.02				1400.328		
B	Co Generation							
a	Bagasse (Co-gen)							
1	A.B. Sugars Ltd	23	Bagasse (Co-gen)	Long Term	66 KV	69.820	66	ISB
2	Chadha Sugars & Ind. Ltd.	23	Bagasse (Co-gen)	Long Term	66 KV SS,	57.896	66	ISB
3	Indian Sucrese Ltd	40	Bagasse (Co-gen)	Long Term	132 KV Uchi	25.961	66	ISB
4	Nawanshahar Power Pvt. Ltd.	15	Bagasse (Co-gen)	Long Term	132 KV	17.772	66	ISB
5	Rana Sugars Ltd (34MW)	34	Bagasse (Co-gen)	Long Term	66 KV	33.045	66	ISB
6	Wahid Sandhar Sugars Ltd.	12	Bagasse (Co-gen)	Long Term	66 KV SS	10.392	33	ISB
7	The Bhogpur Co-op Sugar Mills Ltd.	15	Bagasse (Co-gen)	Long Term	66 KV	2.777	66	ISB
	Total co-gen Bagasse	182				217.662		
b	Biomass (Co-gen)							
1	A.B. Grains Spirits Pvt. Ltd.	5.5	Biomass (Co-gen)	Long Term	66 KV Rajoa	3.140	66	ISB
2	Chandigarh Distillers & Bottlers Ltd. (8.25 MW)	8.25	Biomass (Co-gen)	Long Term	66 KV Banur	2.420	66	ISB
3	Chandigarh Distillers & Bottlers Ltd. (3.9 MW)	3.9	Biomass (Co-gen)	Long Term	66 KV Banur	4.108	66	ISB
4	Indian Acrylics Pvt Ltd	7.75	Biomass (Co-gen)	Long Term	66 KV	0.000	66	ISB
6	N.V. Distilleries & Breweries Pvt. Ltd.	10	Biomass (Co-gen)	Long Term	66 KV	28.878	66	ISB
7	Shree Ganesh Edibles Pvt. Ltd	0	Biomass (Co-gen)	Long Term	66 KV	0.002	11	ISB
8	Shree Ganesh Edibles Pvt. Ltd. (New PPA)	15	Biomass (Co-gen)	Long Term	#N/A	2.039	66	ISB
	Total Co-Gen Biomass	50.40				40.587		
	Total Cogen Bagasse+Biomass	212.40				258.249		
C	Biomass/IPP							
1	Dee Development Engineers Pvt. Ltd	8	Biomass/IPP	Long Term	66 KV	55.270	66	ISB
2	Green Planet Energy Pvt. Ltd., BirPind	6	Biomass/IPP	Long Term	66 KV SS	11.429	66	ISB
3	Green Planet Energy Pvt. Ltd., Binjon (Rankine cycle)	6	Biomass/IPP	Long Term	33/ 66 KV	10.992	66	ISB
4	Malwa Power Pvt.Ltd	6	Biomass/IPP	Long Term	66 KV	44.892	66	ISB
5	Sukhbir Agro Energy Ltd. (Ferozepur)	18	Biomass/IPP	Long Term	132 KV	105.937	132	ISB
6	Sukhbir Agro Energy Ltd. (Jaito)	18	Biomass/IPP	Long Term	220 KV	117.143	66	ISB
7	Universal Biomass Energy Pvt. Ltd.	14.5	Biomass/IPP	Long Term	132 KV	70.284	132	ISB
8	Viaton Energy Pvt. Ltd.	10	Biomass/IPP	Long Term	66 KV	55.335	66	ISB
	Total Biomass/IPP	86.50				471.283		ISB
D	Waste to energy							ISB
1	Halbawal Biomethanation LDH	1	Waste to energy	Long Term	66 KV	-0.699	11	ISB
	Total Waste to energy	1.00				-0.699		ISB
E	Biogas							ISB
1	Green Planet Energy Pvt. Ltd, Binjon export (ootto cycle)	4	Biogas	Long Term	66 KV SS	1.369	66	ISB
2	Sampuran Agri Ventures Ltd.	1	Biogas	Long Term	66 KV	0.326	11	ISB
	Total Biogas	5				1.695		ISB

S. EDDSM,
P.S.P.C.L., Patiala

Lains
Er. Ravi Verma
EA- 7969
Energy Auditor
PSPCL, Patiala.

F	Mini Hydel							ISB
a	Aqua Power Plant Ltd.							ISB
1	Chakbhai MHP	2	Mini Hydel	Long Term	66 KV	8.577	11	ISB
2	Lohgerh	2	Mini Hydel	Long Term	66 KV	7.551	11	ISB
3	Sidhana	1.2	Mini Hydel	Long Term	66 KV Phul	5.725	11	ISB
	Aqua Power Plant Ltd. Total	5.2				21.853		ISB
b	Abohar Power Generation Pvt. Ltd.							ISB
1	Gholla MHP	0.8	Mini Hydel	Long Term	132 KV	2.913	11	ISB
2	Chanuwal MHP	0.9	Mini Hydel	Long Term	66 KV	2.912	11	ISB
3	Akhara MHP	1.1	Mini Hydel	Long Term	66 KV	4.118	11	ISB
4	Khanpur	1.1	Mini Hydel	Long Term	132 KV	4.657	11	ISB
5	Sudhar	1.4	Mini Hydel	Long Term	66 KV	4.664	11	ISB
	Abohar Power Generation TOTAL	5.30				19.263		ISB
c	Kotla Hydro Ltd							ISB
1	Babanpur MHP	1.25	Mini Hydel	Long Term	66 KV Dhuri	5.081	11	ISB
2	Killa	1.75	Mini Hydel	Long Term	66 KV	9.250	11	ISB
3	Sahoke	1.2	Mini Hydel	Long Term	66 KV	6.300	11	ISB
	Kotla Hydro Ltd.Total	4.2				20.631		ISB
d	Punjab Hydro Ltd.							ISB
1	Dolowal MHP	0	Mini Hydel	Long Term	66 KV	4.995	11	ISB
2	Saler MHP	0	Mini Hydel	Long Term	66 KV	5.198	11	ISB
3	Bhanubura MHP	0	Mini Hydel	Long Term	66 KV	5.623	11	ISB
	Punjab Hydro Ltd. Total.	0				15.815		ISB
e	Individual hydel Plant							ISB
1	Atlantic Power Pvt. Ltd.(Phoola)	0.80	Mini Hydel	Long Term	66 KV	2.281	11	ISB
2	Atlantic Power Pvt. Ltd. (Nakkian)	0.30	Mini Hydel	Long Term	132 KV	1.261	11	ISB
3	Atlantic Power Pvt. Ltd. (Tarkiana)	0.85	Mini Hydel	Long Term	66 KV	3.149	11	ISB
4	Atlantic Power Pvt. Ltd. (Tarkiana) PSPCL Free energy share	0.00	Mini Hydel	Long Term		1.350	11	ISB
5	Gill Aqua Hydro Power Generation Co. Pvt. Ltd. -MBL-II	6.00	Mini Hydel	Long Term	66 KV	12.578	66	ISB
6	Gill Aqua Hydro Power Generation Co. Pvt. Ltd. -MBL-III	3.80	Mini Hydel	Long Term	66 KV	7.130	66	ISB
7	Gill Power Generation Co. (P) Ltd.	2.70	Mini Hydel	Long Term	220 KV	8.056	11	ISB
8	Himalayan Renewable Energy Pvt. Ltd.	0.80	Mini Hydel	Long Term	66 KV	4.008	11	ISB
9	Kotla Renewables Pvt. Ltd. Daudhar	1.50	Mini Hydel	Long Term	220 KV	4.494	11	ISB
10	Kotla Renewables Pvt. Ltd. Nidampur	0.80	Mini Hydel	Long Term	66 KV	1.429	11	ISB
11	Kotla Renewables Pvt. Ltd. Thuhi	0.80	Mini Hydel	Long Term	66 KV	2.075	11	ISB
12	Majha Canal Hydro Project Pvt.Ltd.Udhanwal	0.65	Mini Hydel	Long Term	66 KV	0.658	11	ISB
13	P & R Gurdithwala Hydro Power Pvt. Ltd.	2.00	Mini Hydel	Long Term	66 KV	8.553	11	ISB
14	Preetek Power Pvt. Ltd. (Tugalwal)	0.85	Mini Hydel	Long Term	66 KV	1.282	11	ISB
15	Sam India Hydro Power Pvt. Ltd.	1.20	Mini Hydel	Long Term	132 KV	3.424	11	ISB
16	Sidhwan Hydro Power Pvt. Ltd.	0.70	Mini Hydel	Long Term	66 KV	1.964	11	ISB
17	SKR Hydro Power Generators Pvt. Ltd.	0.40	Mini Hydel	Long Term	66 KV	0.873	11	ISB
18	UBDC Hydro Company	2.00	Mini Hydel	Long Term	66 KV S/Stn	8.233	11	ISB
19	Preetek Power Pvt. Ltd. (Kalabal)	0.80	Mini Hydel	Long Term	0	1.246	11	ISB
20	Hydro Energy & Infrastructure	0.25	Mini Hydel	Long Term	66KV	0.979	11	ISB
21	Sahasr Hydro Urja Pvt. Ltd.	1.50	Mini Hydel	Long Term	Lohgarh	11.495	11	ISB

S. E. DSM,
P.S.P.C.L., Patiala
[Signature]

Ravi Verma
Er. Ravi Verma
EA- 7969
Energy Auditor
PSPCL, Patiala.

	Individual Hydel Total	28.10				86.518		ISB
								ISB
f	Punjab Genco Ltd.							ISB
1	Narangwal MHP	1.50	Mini Hydel	Long Term	66 KV	4.528	11	ISB
2	Dalla MHP	1.00	Mini Hydel	Long Term	66 KV Rumi	2.958	11	ISB
3	Tugal MHP	1.50	Mini Hydel	Long Term	66 KV	4.614	11	ISB
4	Chupki MHP	1.50	Mini Hydel	Long Term	66 KV	5.118	11	ISB
5	Khatra MHP	1.00	Mini Hydel	Long Term	66 KV Slar	2.208	11	ISB
6	Kanganwal MHP	1.30	Mini Hydel	Long Term	66 KV	3.912	11	ISB
7	Bowani MHP	1.00	Mini Hydel	Long Term	132 KV	1.409	11	ISB
8	Jagera MHP	1.00	Mini Hydel	Long Term	66 KV	4.379	11	ISB
	Total PGL	9.80				29.126		
	Total Mini Hydel	52.60				193.205		
G	Wind Power							
1	SECI Wind Power (150 MW)	150	Wind Power	Long Term	Outside	418.253		
2	SECI Wind Power (200 MW)	200	Wind Power	Long Term	Outside	541.234		
	Total Wind Power	350				959.486		
H	Short Term Hybrid Power							
i	SECI 500 MW Hybrid Power PSA (Solar)	400	Short Term Hybrid Power	Short Term	Outside	1012.258		
ii	SECI 500 MW Hybrid Power PSA (Wind)	100	Short Term Hybrid Power	Short Term	Outside	294.805		
I	Short Term NHPC Solar Power	300		Short Term	Outside	316.309		
J	2% Energy Injection by OA Consumers in lieu of							
1	Winsome Yarns Non Solar					0.212		
2	Nahar Industrial Enterprises Ltd. Non Solar					0.198		
	Total 2% Energy Injection by OA Consumers					0.410		
k	Own Hydel							
1	Micro Hydel							
(i)	Rohti	0.8	Micro Hydel			0.000	11	
(ii)	Ropar	1.7	Micro Hydel			5.328	11	
	Total Micro Hydel	2.5				5.328		
2	UBDC Stage I&II	91.35	Micro Hydel			374.120	132	
3	Mukerian MHP-5	18	Micro Hydel			76.761	132	
	Total Own Hydel	111.85				456.209		
1	SOLAR							
i	Solar Intra state	884.02				1292.026		
ii	Bundled (Solar)	37				52.482		
iii	SECI Solar	30				55.819		
iv	SECI Hybrid Solar	400				1012.258		
v	NHPC Solar	300				316.309		
	Total Solar	1651.02				2728.894		
2	NON SOLAR							

S.E./DSM,
P.S.P.C.L., Patiala

Er. Ravi Verma
EA- 796
Energy Auditor
PSPCL, Patiala.

i	NON SOLAR (HYDEL)	164.45			649.414	
ii	NON SOLAR (WIND)	380.00			959.486	
iii	NON SOLAR (OTHERS)	304.99			730.527	
v	Non Solar (2% Injection in lieu of Transmission Charges)				0.410	
vi	SECI Hybrid Wind	100.00			294.805	
	Total Non Solar	919.35			2634.642	
	Total for Long Term and Short Term RE Power	2570.37			5363.536	
	Bundled NRVNL Coal	37.00		Long Term	Outside	239.444
	Total Bundled NRVNL (Coal+ Solar)	74.00				291.926
	NRSE Power Purchase Within Punjab					
	At 11 KV					230.072
	At 33 KV					10.392
	At 66 KV					1610.023
	At 132 KV and above					365.272
	Total NRSE Power Purchase within Punjab					2215.759

S.E./DSM,
P.S.P.C.L., Patiala
Km

Ravi
Er. Ravi Verma
EA- 7969
Energy Auditor
PSPCL, Patiala.

B. Embedded Generation in DISCOM Area																
S.No	Name of Generation Station / Sub-Division	Generation Capacity (in MW)	Type of Station (Generation based- Solid/Liquid/Gas/Renewable /Others)	Type of Contract	Type of Grid	Voltage Level (KV/A)	Circle Load (MW)	Received at Circle (KVA)	Received at Circle (in MW)	Division Level Load (MW)	Received at Division Level (KVA)	Received at Division Level (in MW)	Sub-Division Level Load (MW)	Received at Sub-Division Level (KVA)	Received at Sub-Division Level (in MW)	Remarks (Source of data)
1	DS S/D GHEE MANDI TECH, ASR	NA	Renewable Solar			LT									0.024	
2	DS S/D HUSSAINPURA TECH, ASR	NA	Renewable Solar			LT									0.051	
3	DS S/D MALL MANDI TECH, ASR	NA	Renewable Solar			LT									0.565	
4	DS S/D CIVIL LINE TECH., ASR	NA	Renewable Solar			LT									1.397	
5	DS S/D ISLAMABAD TECH., ASR	NA	Renewable Solar			LT									1.026	
6	DS S/D LAWRENCE ROAD TECH., ASR	NA	Renewable Solar			LT									3	
7	DS S/D DURGHANA TEMPLE TECH., ASR	NA	Renewable Solar			LT									0	
8	DS S/D HAKIMA GATE TECH., ASR	NA	Renewable Solar			LT									0	
9	DS S/D TUNDA TALAB TECH., ASR	NA	Renewable Solar			LT									0	
10	DS GOLDEN TEMPLE TECH., ASR	NA	Renewable Solar			LT									1.145	
11	DS S/D CHATWIND TECH., ASR	NA	Renewable Solar			LT									0.387	
12	DS S/D SULTANWIND TECH., ASR	NA	Renewable Solar			LT									1.287	
13	DS S/D City BATALA	NA	Renewable Solar			LT									0.081	
14	DS S/D East BATALA	NA	Renewable Solar			LT									0.228	
15	DS S/D PANJ GRAIAN	NA	Renewable Solar			LT									0.002	
16	DS S/D SOUTH BATALA	NA	Renewable Solar			LT									0	
17	DS S/D UDHANWAL	NA	Renewable Solar			LT									0	
18	DS S/D WEST S/D BATALA	NA	Renewable Solar			LT									0	
19	DS S/D MIRTHAL	NA	Renewable Solar			LT									0	
20	DS S/D HAJIMAL SINGH	NA	Renewable Solar			LT									0	
21	DS S/D NORTH PATHANKOT	NA	Renewable Solar			LT									0.1986	
22	DS S/D SARNA	NA	Renewable Solar			LT									0	
23	DS S/D SOUTH PATHANKOT	NA	Renewable Solar			LT									0.433	
24	DS S/D SUJANPUR	NA	Renewable Solar			LT									0	
25	DS S/D GHUMAN	NA	Renewable Solar			LT									0	
26	DS S/D HARCHOWAL	NA	Renewable Solar			LT									0	
27	DS S/D KANHUWAN	NA	Renewable Solar			LT									0	
28	DS S/D QADIAN	NA	Renewable Solar			LT									0	
29	DS S/D SRI HARGOBINDPUR	NA	Renewable Solar			LT									0	
30	DS S/D DEHRWAL	NA	Renewable Solar			LT									0	
31	DS S/D DHARWAL	NA	Renewable Solar			LT									0	
32	DS S/D KALANALR	NA	Renewable Solar			LT									0	
33	DS S/D N/MAJHA SINGH	NA	Renewable Solar			LT									0	
34	DS CITY S/D GURDASPUR	NA	Renewable Solar			LT									0	
35	DS S/D BEHRAMPUR	NA	Renewable Solar			LT									0	
36	DS S/D DORANGLA	NA	Renewable Solar			LT									0	
37	DS S/D JOURIAN CHHETRIAN	NA	Renewable Solar			LT									0	
38	DS S/D PURANA SHELLA	NA	Renewable Solar			LT									0	
39	DS S/D THBAR	NA	Renewable Solar			LT									0	
40	DS S/D S/D GURDASPUR	NA	Renewable Solar			LT									0	
41	DS CITY S/D FATEHGARH CHURIAN	NA	Renewable Solar			LT									0	
42	DS S/D ALWAL	NA	Renewable Solar			LT									0	
43	DS S/D DERA BABA NANAK	NA	Renewable Solar			LT									0	
44	DS S/D KOTLI SURAT MALHI	NA	Renewable Solar			LT									0	
45	DS S/D M/TOWN S/D BATALA	NA	Renewable Solar			LT									0	
46	DS S/D NORTH S/D BATALA	NA	Renewable Solar			LT									0	
47	DS EAST S/D PATHANKOT	NA	Renewable Solar			LT									0.534	
48	DS S/D DHAR	NA	Renewable Solar			LT									0	
49	DS S/D DINA NAGAR	NA	Renewable Solar			LT									0	
50	DS S/D PANDORI	NA	Renewable Solar			LT									0.033	
51	DS S/D BANGALA	NA	Renewable Solar			LT									0	
52	DS S/D FATEHPUR RAJPUTAN	NA	Renewable Solar			LT									0	
53	DS S/D JANDIALA GURU	NA	Renewable Solar			LT									0	
54	DS S/D KOT MIT SINGH	NA	Renewable Solar			LT									0.091	
55	DS S/D TANGRA	NA	Renewable Solar			LT									0	
56	DS GOPAL NAGAR S/D	NA	Renewable Solar			LT									0	
57	DS S/D CHHEHARTA	NA	Renewable Solar			LT									0	
58	DS S/D East Commercial	NA	Renewable Solar			LT									0.185	
59	DS S/D EAST TECH(East+Verka)	NA	Renewable Solar			LT									0.197	
60	DS S/D WEST ASR	NA	Renewable Solar			LT									0	
61	DS SOUTH S/D	NA	Renewable Solar			LT									1.625	
62	DS S/D HAMSHA CHINNA	NA	Renewable Solar			LT									0	
63	DS S/D KATHUMANGAL	NA	Renewable Solar			LT									0	
64	DS S/D NO-1 MARTHIA	NA	Renewable Solar			LT									0	

Ravi
Er. Ravi Verma
EA- 7969
Energy Auditor
PSPCL, Patiala.

S.E./DSM,
P.S.P.C.L., Patiala
Ma

(Details of Consumers)						
Summary of Energy						
Period From 01.04.2022 To 31.03.2023						
S.No	Type of Consumers	Category of Consumers (EHT/HT/LT/Others)	Voltage Level (In Voltage)	No of Consumers	Total Consumption (In MU)	Remarks (Source of data)
1	Domestic	EHT/HT/LT	400/220/66/33/11/LT	7738346	17493.719	
2	Commercial	EHT/HT/LT	400/220/66/11/LT	1223854	4485.033	
3	IP Sets					
4	Hor. & Nur. & Coffee/Tea & Rubber (Metered)					
5	Hor. & Nur. & Coffee/Tea & Rubber (Flat)					
6	Heating and Motive Power					
7	Water Supply			15720		
8	Public Lighting	LT	LT	5644	143.284	
9	HT Water Supply			246		
10	HT Industrial	EHT/HT	400/132/66/11	14410	17359.147	
11	Industrial (Small)	LT		95605	1143.211	
12	Industrial (Medium)	LT		28385	2442.079	
13	HT Commercial	EHT/HT/LT	400/220/66/33/11/LT			
14	Applicable to Government Hospitals & Hospitals					
15	Lift Irrigation Schemes/Lift Irrigation Societies					
16	HT Res. Apartments Applicable to all areas					
17	Mixed Load					
18	Government offices and department					
19	Others-1 (if any , specify in remarks)	Agricultural power	LT	1390944	13762.570	
20	Others-2 (if any , specify in remarks)	Railway Traction	400/132	4	34.042	
21	Others-3 (if any , specify in remarks)	Bulk	LT/11/33	536	680.018	
22	Others-4 (if any , specify in remarks)	AP High Technology, Waste management & charitable hospitals		56		Consumption taken in the category to which it falls
23	Others-5 (if any , specify in remarks)					
24	Theft Units, Short Assesment, Unbilled Revenue(Eq.Units)				163.09	
25	Misc. adjustment to match with planning				1002.41	
26						
27						
28						
				Total	10513750	58708.60

*S.E./DSM,
P.S.P.C.L., Patiala*

Er. Ravi Verma
EA- 7969
Energy Auditor
PSPCL, Patiala.

(Details of Feeder-wise losses)																			
01.04.2022 To 31.03.2023																			
Sl No.	Zone	Circle	Received at Circle (In MU)	Division	Received at Division (In MU)	Subdivision	Received at Sub Division (In MU)	Name of the Station	Feeder Code/ID	Feeder Name	Type of Feeder (Urban/Wind/Ind ustrial/Agricultural/Rural)	Type of Feeder (AMR/AMR/Other)	Received at Feeder (Final In MU)	Feeder Consumption (In MU)	Final Net Export at Feeder Unvrl (In MU)	T&D losses	AT&C losses	% Data Received through Automatically (If Feeder AMR/AM)	Remarks
1	Border	CITY AMRITSAR		DS CITY CENTER DIVN., ASR		DS S/D GHEE MANDI TECH. ASR	64.7257		C751FL03	11kv NEW GOLDEN AVENUE	Category 1	AMR	5.220						Feeder wise T&D and AT&C losses are not available currently
2	Border	CITY AMRITSAR		DS CITY CENTER DIVN., ASR		DS S/D GHEE MANDI TECH. ASR			C754FL01	HUSSAINPURA	Category 1	AMR	7.634						
3	Border	CITY AMRITSAR		DS CITY CENTER DIVN., ASR		DS S/D GHEE MANDI TECH. ASR			C751FL02	Head Water Works Road	Category 1	AMR	8.306						
4	Border	CITY AMRITSAR		DS CITY CENTER DIVN., ASR		DS S/D GHEE MANDI TECH. ASR			C751FL08	11kv New Rav Dass Road	Category 1	AMR	10.577						
5	Border	CITY AMRITSAR		DS CITY CENTER DIVN., ASR		DS S/D GHEE MANDI TECH. ASR			C754FL13	11KV NEW KESRI BAGH	Category 1	AMR	2.649						
6	Border	CITY AMRITSAR		DS CITY CENTER DIVN., ASR		DS S/D GHEE MANDI TECH. ASR			D754FL02	11kv Ghee Mandi 2	Category 1	AMR	5.263						
7	Border	CITY AMRITSAR		DS CITY CENTER DIVN., ASR		DS S/D GHEE MANDI TECH. ASR			D754FL01	11kv Kesri Bagh	Category 1	AMR	5.889						
8	Border	CITY AMRITSAR		DS CITY CENTER DIVN., ASR		DS S/D GHEE MANDI TECH. ASR			D754FL09	11 KV MOTI BAZAR	Category 1	AMR	6.132						
9	Border	CITY AMRITSAR		DS CITY CENTER DIVN., ASR		DS S/D GHEE MANDI TECH. ASR			D754FL04	11kv Chattwind	Category 1	AMR	6.518						
10	Border	CITY AMRITSAR		DS CITY CENTER DIVN., ASR		DS S/D GHEE MANDI TECH. ASR			D754FL03	11kv Navdeep Theatre	Category 1	AMR	6.538						
11	Border	CITY AMRITSAR		DS CITY CENTER DIVN., ASR		DS S/D GHEE MANDI TECH. ASR			D751FL19	11 KESRI BAGH HG	Category 1	AMR	0.000						
12	Border	CITY AMRITSAR		DS CITY CENTER DIVN., ASR		DS S/D GHEE MANDI TECH. ASR			D751FL20	DHARAM SINGH MKRT INTERLINK	Category 1	AMR	0.000						
13	Border	CITY AMRITSAR		DS CITY CENTER DIVN., ASR		DS S/D HUSSAINPURA TECH. ASR			D754FL12	BHARAWA DA DHABHA	Category 1	AMR	0.000						
14	Border	CITY AMRITSAR		DS CITY CENTER DIVN., ASR		DS S/D HUSSAINPURA TECH. ASR			D754FL14	11 KV SUBAHS PARK	Category 1	AMR	0.000						
15	Border	CITY AMRITSAR		DS CITY CENTER DIVN., ASR		DS S/D HUSSAINPURA TECH. ASR			D754FL15	11 KV MASHI MANDI	Category 1	AMR	0.000						
16	Border	CITY AMRITSAR		DS CITY CENTER DIVN., ASR		DS S/D HUSSAINPURA TECH. ASR			D754FL26	Kalron Market	Category 1	NON AMR	0.000						
17	Border	CITY AMRITSAR		DS CITY CENTER DIVN., ASR		DS S/D HUSSAINPURA TECH. ASR			D754FL13	11 KV TOWN HALL	Category 1	AMR	1.627						
18	Border	CITY AMRITSAR		DS CITY CENTER DIVN., ASR		DS S/D HUSSAINPURA TECH. ASR			D754FL05	Cheef Mandi	Category 1	AMR	9.391						
19	Border	CITY AMRITSAR		DS CITY CENTER DIVN., ASR		DS S/D HUSSAINPURA TECH. ASR			D752FL10	11KV HussainPura	Category 1	AMR	10.334						
20	Border	CITY AMRITSAR		DS CITY CENTER DIVN., ASR		DS S/D HUSSAINPURA TECH. ASR	47.8845		D751FL04	11kv Hall Bazar	Category 1	AMR	0.000						
21	Border	CITY AMRITSAR		DS CITY CENTER DIVN., ASR		DS S/D HUSSAINPURA TECH. ASR			D751FL10	11 KV Katra Baghian	Category 1	AMR	0.000						
22	Border	CITY AMRITSAR		DS CITY CENTER DIVN., ASR		DS S/D HUSSAINPURA TECH. ASR			D751FL14	11KV Civil Hospital independent	Category 2	AMR	1.213						
23	Border	CITY AMRITSAR		DS CITY CENTER DIVN., ASR		DS S/D HUSSAINPURA TECH. ASR			D751FL23	MASHI MANDI	Category 1	AMR	1.692						
24	Border	CITY AMRITSAR		DS CITY CENTER DIVN., ASR		DS S/D HUSSAINPURA TECH. ASR			D751FL22	BHARAWA DA DHABHA	Category 1	AMR	1.885						
25	Border	CITY AMRITSAR		DS CITY CENTER DIVN., ASR	324.3589	DS S/D HUSSAINPURA TECH. ASR			D751FL25	SUBASH PARK	Category 1	AMR	2.496						
26	Border	CITY AMRITSAR		DS CITY CENTER DIVN., ASR		DS S/D HUSSAINPURA TECH. ASR			D751FL24	KARION MARKET	Category 1	NON AMR	9.567						
27	Border	CITY AMRITSAR		DS CITY CENTER DIVN., ASR		DS S/D HUSSAINPURA TECH. ASR			D751FL21	TOWN HALL	Category 1	AMR	4.111						
28	Border	CITY AMRITSAR		DS CITY CENTER DIVN., ASR		DS S/D HUSSAINPURA TECH. ASR			D751FL07	11kv saraswati	Category 1	AMR	4.632						
29	Border	CITY AMRITSAR		DS CITY CENTER DIVN., ASR		DS S/D HUSSAINPURA TECH. ASR			D751FL02	11KV Ram Bagh	Category 1	AMR	6.936						
30	Border	CITY AMRITSAR		DS CITY CENTER DIVN., ASR		DS S/D MALL MANDI TECH. ASR			C751DL11	11 KV Bhai Gurdas Ji Nagar	Category 1	NON AMR	4.101						
31	Border	CITY AMRITSAR		DS CITY CENTER DIVN., ASR		DS S/D MALL MANDI TECH. ASR			C751FL14	Kapoor Nagar	Category 1	AMR	7.299						
32	Border	CITY AMRITSAR		DS CITY CENTER DIVN., ASR		DS S/D MALL MANDI TECH. ASR			C751FL13	Gobind Nagar	Category 1	AMR	13.171						
33	Border	CITY AMRITSAR		DS CITY CENTER DIVN., ASR		DS S/D MALL MANDI TECH. ASR			C801FL03	J C MOTOR	Category 2	AMR	0.000						
34	Border	CITY AMRITSAR		DS CITY CENTER DIVN., ASR		DS S/D MALL MANDI TECH. ASR			C801FL2	KHANKOT	Category 1	AMR	1.631						
35	Border	CITY AMRITSAR		DS CITY CENTER DIVN., ASR		DS S/D MALL MANDI TECH. ASR			C801FL08	Byepass	Category 1	AMR	5.553						
36	Border	CITY AMRITSAR		DS CITY CENTER DIVN., ASR		DS S/D MALL MANDI TECH. ASR			C801FL06	GT road	Category 1	AMR	11.540						
37	Border	CITY AMRITSAR		DS CITY CENTER DIVN., ASR		DS S/D MALL MANDI TECH. ASR			C805FL04	Bhai Lafoj Nagar	Category 1	AMR	13.391						
38	Border	CITY AMRITSAR		DS CITY CENTER DIVN., ASR		DS S/D MALL MANDI TECH. ASR			C801FL13	GTB FOCAL POINT	Category 2	AMR	13.879						
39	Border	CITY AMRITSAR		DS CITY CENTER DIVN., ASR		DS S/D MALL MANDI TECH. ASR			C801FL10	New Focal point	Category 2	AMR	14.696						
40	Border	CITY AMRITSAR		DS CITY CENTER DIVN., ASR		DS S/D MALL MANDI TECH. ASR	211.7487		C801FL11	New Amritsar	Category 1	AMR	15.829						
41	Border	CITY AMRITSAR		DS CITY CENTER DIVN., ASR		DS S/D MALL MANDI TECH. ASR			C801FL02	Focpoint old	Category 2	AMR	23.059						
42	Border	CITY AMRITSAR		DS CITY CENTER DIVN., ASR		DS S/D MALL MANDI TECH. ASR			D945FL04	Bhai Ghaniya Ji	Category 1	AMR	2.330						
43	Border	CITY AMRITSAR		DS CITY CENTER DIVN., ASR		DS S/D MALL MANDI TECH. ASR			D945FL01	BABA DEEP SINGH	Category 1	AMR	7.942						
44	Border	CITY AMRITSAR		DS CITY CENTER DIVN., ASR		DS S/D MALL MANDI TECH. ASR			945FL06	11 KV SULTANWIND-1	Category 1	NON AMR	11.035						
45	Border	CITY AMRITSAR		DS CITY CENTER DIVN., ASR		DS S/D MALL MANDI TECH. ASR			D945FL05	BABA BUDHA Ji	Category 1	AMR	11.478						
46	Border	CITY AMRITSAR		DS CITY CENTER DIVN., ASR		DS S/D MALL MANDI TECH. ASR			945FL07	11 KV DABURJI	Category 1	NON AMR	12.388						
47	Border	CITY AMRITSAR		DS CITY CENTER DIVN., ASR		DS S/D MALL MANDI TECH. ASR			D945FL02	ATTARI SAHIB	Category 1	AMR	16.310						
48	Border	CITY AMRITSAR		DS CITY CENTER DIVN., ASR		DS S/D MALL MANDI TECH. ASR			D832FL10	11 KV VALLAH	Category 1	AMR	12.843						
49	Border	CITY AMRITSAR		DS CITY CENTER DIVN., ASR		DS S/D MALL MANDI TECH. ASR			C751DL01	Alpha G	Category 1	Not available	13.273						
50	Border	CITY AMRITSAR		DS CIVIL LINE DIVN., ASR		DS S/D CIVIL LINE TECH. ASR			D846FL05	BEAUTY AVENUE	Category 1	AMR	6.863						
51	Border	CITY AMRITSAR		DS CIVIL LINE DIVN., ASR		DS S/D CIVIL LINE TECH. ASR			D755FL08	DMT	Category 1	AMR	0.676						
52	Border	CITY AMRITSAR		DS CIVIL LINE DIVN., ASR		DS S/D CIVIL LINE TECH. ASR			D755FL07	DISTRICT COURT	Category 1	AMR	2.230						
53	Border	CITY AMRITSAR		DS CIVIL LINE DIVN., ASR		DS S/D CIVIL LINE TECH. ASR			D755FL09	COURT ROAD	Category 1	AMR	2.778						
54	Border	CITY AMRITSAR		DS CIVIL LINE DIVN., ASR		DS S/D CIVIL LINE TECH. ASR			D755FL02	CANTY ROAD	Category 1	AMR	4.307						
55	Border	CITY AMRITSAR		DS CIVIL LINE DIVN., ASR		DS S/D CIVIL LINE TECH. ASR	76.9077		D755FL10	MAHINDERA COLONY	Category 1	AMR	4.432						
56	Border	CITY AMRITSAR		DS CIVIL LINE DIVN., ASR		DS S/D CIVIL LINE TECH. ASR			D755FL03	PANI KA BAGH	Category 1	AMR	5.608						
57	Border	CITY AMRITSAR		DS CIVIL LINE DIVN., ASR		DS S/D CIVIL LINE TECH. ASR			D755FL05	MOHAN HOTEL	Category 1	AMR	6.497						
58	Border	CITY AMRITSAR		DS CIVIL LINE DIVN., ASR		DS S/D CIVIL LINE TECH. ASR			D755FL11	KENNEDY AVENUE	Category 1	AMR	6.771						
59	Border	CITY AMRITSAR		DS CIVIL LINE DIVN., ASR		DS S/D CIVIL LINE TECH. ASR			D755FL06	MODEL TOWN	Category 1	AMR	6.960						
60	Border	CITY AMRITSAR		DS CIVIL LINE DIVN., ASR		DS S/D CIVIL LINE TECH. ASR			D755FL01	GREEN AVENUE	Category 1	AMR	9.285						
61	Border	CITY AMRITSAR		DS CIVIL LINE DIVN., ASR		DS S/D CIVIL LINE TECH. ASR			D801FL01	BASANT AVENUE	Category 1	AMR	5.868						
62	Border	CITY AMRITSAR		DS CIVIL LINE DIVN., ASR		DS S/D CIVIL LINE TECH. ASR			D801FL09	AMAND AVENUE	Category 1	AMR	6.148						
63	Border	CITY AMRITSAR		DS CIVIL LINE DIVN., ASR		DS S/D CIVIL LINE TECH. ASR			D801FL07	GOBIND PARK	Category 1	AMR	8.486						
64	Border	CITY AMRITSAR		DS CIVIL LINE DIVN., ASR		DS S/D ISLAMABAD TECH. ASR			D838FL01	KISHANKOT	Category 1	AMR	4.918						
65	Border	CITY AMRITSAR		DS CIVIL LINE DIVN., ASR		DS S/D ISLAMABAD TECH. ASR			D838FL03	GURUDWARA TAPOWAN	Category 1	AMR	5.197						
66	Border	CITY AMRITSAR		DS CIVIL LINE DIVN., ASR		DS S/D ISLAMABAD TECH. ASR			D838FL06	11 KV Haripura Feeder	Category 1	AMR	7.082						
67	Border	CITY AMRITSAR		DS CIVIL LINE DIVN., ASR		DS S/D ISLAMABAD TECH. ASR			D838FL02	BHANDARI CHOWK	Category 1	AMR	8.520						
68	Border	CITY AMRITSAR		DS CIVIL LINE DIVN., ASR		DS S/D ISLAMABAD TECH. ASR			D838FL04	KHOO BHALLA	Category 1	AMR	10.889						
69	Border	CITY AMRITSAR		DS CIVIL LINE DIVN., ASR		DS S/D ISLAMABAD TECH. ASR	83.0146		D838FL08	NAVANKOT	Category 1	AMR	11.911						
70	Border	CITY AMRITSAR		DS CIVIL LINE DIVN., ASR		DS S/D ISLAMABAD TECH. ASR			D838FL05	DHAPAI INDUSTRIAL	Category 1	AMR	15.454						
71	Border	CITY AMRITSAR		DS CIVIL LINE DIVN., ASR		DS S/D ISLAMABAD TECH. ASR			D753FL04	CHAH NIHANGA	Category 1	AMR	0.000						
72	Border	CITY AMRITSAR		DS CIVIL LINE DIVN., ASR	287.6375	DS S/D ISLAMABAD TECH. ASR			D753FL05	RLY WORKSHOP	Category 1	AMR	3.163						
73	Border	CITY AMRITSAR		DS CIVIL LINE DIVN., ASR		DS S/D ISLAMABAD TECH. ASR			D753FL06	CANAL OFFICE	Category 1	AMR	5.830						
74	Border	CITY AMRITSAR		DS CIVIL LINE DIVN., ASR		DS S/D ISLAMABAD TECH. ASR			D753FL08	swadeshi mill	Category 1								

"A" (Details of Distribution Transformers(DT) Level Information)

Period From 01.04.2022 To 31.03.2023										
Zone	Circle	Division	Feeder Name	Total No. of DT on Feeder	No. of Unmetered DTs	No. of Metered Dts			No. of DTs with functional meters	
1	2	3	4	5=(6+7+8+9)	6	7	8	9	10	11
						AMR metered (Communicable)	AMI metered (Communicable)	Non-AMR/AMI metered (Non communicable)	Communicating (Total No out of 7 and 8)	Non Communicating (Total No out of 7 and 8)
Total Transformers ending month 3/2023										
	5 KVA	6.3 KVA	10 KVA	15 KVA	18 KVA	25 KVA	63 KVA	100 KVA	above 100 KVA	Total
PSPCL	42	91998	367959	1	195407	278305	133281	117537	25800	1200300

Sr. No.	Zone	Circle	Division	Total No. of DTs installed	No. of DTs where AMR Meters Installed	No. of DTs where Non AMR meters Installed	No. of Unmetered DTs	No. of DTs with functional Meters
1	Border	Gurdaspur	City Batala	7113	472	111	6530	583
2			Sub Batala	13264	231	61	12972	292
3			Qadian	12156	185	95	11876	280
4			Dhariwal	7468	118	43	7307	161
5			Gurdaspur	8922	278	133	8511	411
6			City Pathankot	5058	390	164	4504	554
7			Sub Pathankot	4749	412	203	4134	615
			Total	68730	2088	810	68834	2896
8		Sub Asr	EAST	3735	360	216	3159	47
9			WEST	11606	0	41	11565	41
10			SUBURBAN	17571	52	150	17369	197
11		AJNALA	AJNALA	20026	178	9	19839	178
12			JANDIALA	9861	152	17	9692	152
			Total	62799	742	433	61624	615
13		City Asr	Ind	646	223	0	423	20
14			CL	863	520	0	343	212
15			CC	1114	109	0	1005	23
16			HG	485	281	0	204	53
			Total	3108	1133	0	1975	308
17		Tarn Taran	Rayva	15394	40	0	15354	40
18			City TT	15204	162	0	15042	162
19	SUB TT		12563	0	63	12500	63	
20	PATTI		18757	0	98	18659	98	
21	Bhikhiwind	19268	0	0	19268	0		
		Total	81186	202	161	80823	383	
		Border Zone Total	205823	4163	1404	200256	4182	
22	East	CityCenter	339	110	0	229	175	
23		CMC	1299	661	132	506	302	
24		Focal Point	3531	680	2478	373	1950	
25		Sunder	3764	1090	765	1909	1340	
			Total	8933	2541	3375	3017	3787
26	West	Aggar Nagar	2156	0	1135	1021	1031	
27		Modal Town	4244	0	571	3673	0	
28		City West	1618	1296	29	293	1268	
29		Estate	1042	977	16	49	683	
30		Janta Nagar	2262	0	1303	959	920	
		Total	11322	2273	3054	5995	3902	
31	Central	Khanna	8943	575	896	7472	721	
32		Doraha	5036	163	299	4574	301	
33		MGG	1824	106	316	1402	316	
34		Amloh	11286	0	272	11014	0	
35		Sirhind	15590	20	532	15038	12	

S.E.
**S.E./DSM,
P.S.P.C.L., Patiala**

Ravi
**Er. Ravi Verma
EA- 7959
Energy Auditor
PSPCL, Patiala.**

		Total	42679	864	2315	39500	1350
36	S/U Ludhiana	Lalton Kalan	6108	2	0	6106	2
37		Adla Dakha	6359	137	0	0	137
38		Jagraon	8088	325	49	7714	374
39		Raikot	11752	250	0	11502	250
40		Ahmedgarh	5973	218	25	5730	0
		Total	38280	932	74	37274	763
		Central Zone Total	101214	6610	8818	85786	9782
41	Jalandhar	Canit	4489	1099	0	3370	1099
42		East	3199	1296	0	1903	1095
43		MT	4180	716	0	3464	716
44		West	1964	1180	0	784	982
45		Phag	6379	585	69	5725	514
		Total	20191	4876	69	15246	4406
46	Hoshiarpur	City Hsp	4831	472	142	4217	460
47		Sub Hsp	8381	205	0	8176	24
48		Dasuya	6439	128	167	6144	167
49		Mukerian	7387	234	0	7153	212
50		Mahipur	8697	0	72	8625	72
51		Total	6930	71	34	6825	76
		Total	42685	1110	415	41140	1011
52	North Nawanshahar	Newanshaha	6651	363	0	6288	363
53		Banga	6959	0	148	6811	148
54		Garhshanker	8353	253	0	8100	253
55		Goraya	7750	178	270	7302	448
			Total	29713	794	418	28501
56	Kapurthala	City Divn KPT	11710	528	0	11182	528
57		Sub Divn	7429	29	124	7276	153
58		City Nakoder	14563	102	242	14219	344
59		Sub Divn Nakoder	14501	229	0	14272	229
60		Kartarpur	11195	240	254	10701	494
		Total	69398	1128	620	67650	1748
		North Zone Total	151967	7908	1522	142837	8377
61	Patiala	East	14807	0	80	14727	0
62		West	1613	1287	0	326	1182
63		Model Town	1059	990	0	69	388
64		Sub Urban	11918	0	0	11918	0
65		Rajpura	10108	825	0	9283	0
66	Nabha	15723	356	60	15307	320	
67	Samana	17763	807	63	16893	0	
		Total	72991	4265	203	68523	1890
68	Sangrur	Sangrur	17092	522	19	16551	499
69		Sunam	21563	220	2371	18972	2139
70		Lehrogaga	20032	282	0	19750	282
71		Dirba	17510	60	87	17363	78
72		Patran	20212	345	153	19714	450
		Total	96409	1429	2630	92350	3448
73	South Barnala	City Barnala	27860	349	32	27479	105
74		Sub Urban	21516	370	0	21146	370
75		Malerkotla	20504	114	256	20134	0
76		Dhuri	20124	275	15	19834	275
			Total	90004	1108	303	88593
77	Ropar	Ropar	7217	325	0	6892	325
78		Anandpur Sahib	5835	189	0	5646	189
79		Kharrar	8869	0	871	7998	0
80		Samrara	11482	0	250	11232	0
			Total	33403	514	1121	31768
81	Mohali	Mohali	4759	2695	0	2064	1887
82		Zirakpur	5271	531	0	4740	415
83		Lalru	7242	265	0	6977	185
			Total	17272	3491	0	13781
		South Zone Total	310079	10807	4257	295015	9089

*S.E./DSM,
P.S.P.C.L., Patiala*

Lain
Er. Ravi Verma
EA-7969
Energy Auditor
PSPCL, Patiala.

84	West	Bathinda	Bathinda	23185	503	1748	20934	834
85			Rampura	13520	63	30	13427	30
86			Bhagta	19166	0	198	18968	198
87			Maur	29688	0	177	29511	177
88			Mansa	24460	92	207	24161	202
89		Budloda	24173	95	138	23940	233	
			Total	134192	753	2498	130941	1674
90		Faridkot	Faridkot	15962	375	0	15487	84
91			Kotkapura	24677	380	0	24297	89
92			City Moga	17627	380	0	17247	97
93			Sub. Moga	12024	360	0	11664	94
94			Beghapurana	23810	365	0	23445	63
			Total	94000	1860	0	92140	427
95		Ferozepur	City Ferozepur	13267	467	70	12730	385
96	S/U Ferozepur		10928	351	0	10577	195	
97	Jaleelabad		28025	0	95	27930	0	
98	Zira		23566	232	0	23334	0	
			Total	75786	1050	165	74571	580
99	Sri Muktsar Sahib	Muktsar	25876	0	530	25346	326	
100		Melout	26880	336	82	26462	267	
101		Gidderbaha	17568	223	0	17345	0	
102		Abohar	17294	442	96	16756	116	
103		Fazilka	22067	37	335	21695	7	
104	Badal	17554	0	24	17530	5		
		Total	127239	1038	1067	125134	721	
		West Zone	431217	4701	3730	422786	3402	
		PSPCL Grand Total	1200300	34189	19731	1146380	34832	

"8" Details of DT-wise losses (please add more rows as per requirement)

Zone Name	Circle name	Division name	Name of the Sub-division	Name of the Sub-station	Substation Code	Name of the 11 kV Feeder	Feeder Code	Name of the Location where DT situated	DT code	DT Capacity (kVA)	Predominant consumer type of DT (Domestic/Industrial/Agriculture/Mixed)	Type of metering AMR/AMI/Communicable/Conventional metered/Unmetered	Status of Meter-whether Functional (Yes/No)	% of data received automatically (if AMR/AMI)	No. of Connected Consumers	Input Energy (MU) (A)	Billed Energy (MU) (B)	Loss (MU) (A-B)	% DT Loss (A-B)/A

Note : DT wise losses are not available Presently.

S.E./DSM,
P.S.P.C.L., Patiala

Er. Ravi Verma
EA-7969
Energy Auditor
PSPCL, Patiala.

Annexure - 1 : Proforma for Quarterly Consumer Category-wise Subsidy Billed/Received/Due for period April 2022 to March 2023

Quarter-1

Consumer Category (Separate for each subsidized consumer category)	Billed Energy			Subsidized Billed Energy			Applicable rate of Subsidy as notified by State Govt.		Subsidy Due from State Govt.			Subsidy Actually Billed/claimed from State Govt. (As against col.12)	Subsidy Received from State Govt. (As against col.13)	Balance Subsidy yet to be Received from State Govt.			
	Metered	Un-metered*	Total	Metered (out of col.2)	Un-metered* (Out of col.3)	Total	Metered Energy**	Un-metered Energy**	Metered Energy	Un-metered Energy	Total						
	(In kwh)			(In kwh)			(In Rs/Kwh)		(In Rs. Cr.)						(In Rs. Cr.)	(In Rs. Cr.)	(In Rs. Cr.)
	1	2	3	4=2+3	5	6	7=5+6	8	9	10=5x8	11=6x9				12=10+11	13	14
Residential	15986000000		15986000000	15986000000		15986000000			6322.31		6322.31	6322.31	6470.92	-148.61			
Agriculture	13981670000		13981670000	13981670000		13981670000			7913.27		7913.27	7913.27	7294.53	618.74			
Commercial/Industrial-LT	22132290000		22132290000	22132290000		22132290000			2198.88		2198.88	2198.88	2669.01	-470.13			
Commercial/Industrial-HT																	
Other (Specify) WW														0.00			
Total	52099960000	0	52099960000	52099960000	0	52099960000	0.00	0.00	16434.46	0.00	16434.46	16434.46	16434.46	0.00			

- Note: 1 Balance subsidy as per column no. 15 will be claimed after True up of FY 2022-23
Arrears of subsidy ass on 01.04.2022 are not included in above as Liquidation Plan has already been sent to
GoP for approval.
- Note: 2
- Note: 3 Consumption and subsidy data of domestic and industrial category are provisional as the details of same has
not been provided by the O/o CE/IT. The same will be updated after receipt of same from the concerned office.

S.E./DSM,
P.S.P.C.L., Patiala
[Signature]

[Signature]
Er. Ravi Verma
EA- 796g
Energy Auditor
PSPCL, Patiala.